



Mit eXchange  
With eXchange  
Avec échange  
Con eXchange  
Con eXchange



de

**Sichere Diagnose.  
Zeitsparende Reparatur.  
Bosch-Diagnostics und  
Ersatzteile.**

Alles aus einer Hand. Bosch bietet der Werkstatt ein Komplettdiagnoseprogramm zur Steigerung von Effizienz und Qualität in der täglichen Arbeit. Vom weltweit aktiven Entwickler und führenden Hersteller von Kfz-Systemtechnik kommen die Ersatzteile in bekannter Originalqualität.

en

**Reliable diagnosis.  
Time-saving repairs.  
Bosch diagnostics and  
service parts.**

Everything from one single source. Bosch has a complete program available which increases efficiency and quality in the workshop's daily work. The service parts from the globally active development expert and leading manufacturer of automotive system technology are in renowned Bosch OE quality.

fr

**Diagnostic fiable.  
Réparation rapide.  
Diagnostics et pièces  
de rechange Bosch.**

Un unique fournisseur. Bosch propose au garage une gamme complète qui améliore l'efficacité et la qualité du travail quotidien. En tant que concepteur présent dans le monde entier et leader dans la fabrication de systèmes pour automobiles, ses pièces de rechange sont reconnues pour offrir la qualité des pièces d'origine.

it

**Diagnosi sicure.  
Riparazioni rapide.  
Diagnostics, ricambi  
e formazione: tutto  
da un unico fornitore.**

Bosch offre all'officina un programma completo per una maggior efficienza e qualità nel lavoro quotidiano d'autoriparazione. Con il programma «Diagnostics», Bosch mette a disposizione dell'officina anche hardware e software di diagnosi perfettamente in sintonia tra loro oltre a formazione, assistenza e consulenza tecnica. Competenza e qualità, quindi, per il futuro dell'officina.

es

**Diagnóstico seguro.  
Ahorro de tiempo en la  
reparación. Diagnosis  
Bosch y piezas de recambio.**

Todo de un solo proveedor. Bosch, fabricante líder, ofrece al taller un programa completo para incrementar la eficacia y la calidad en el trabajo diario. Bajo el nombre de Diagnosis Bosch se ponen a disposición del taller el hardware y software compatibles entre sí, la formación técnica, la hot-line técnica y la base de datos técnicas. Competencia y calidad para el futuro de su taller.

Dieseleinspritzung | Diesel Fuel Injection | Systèmes d'injection Diesel  
Sistemi di iniezione Diesel | Inyección Diesel

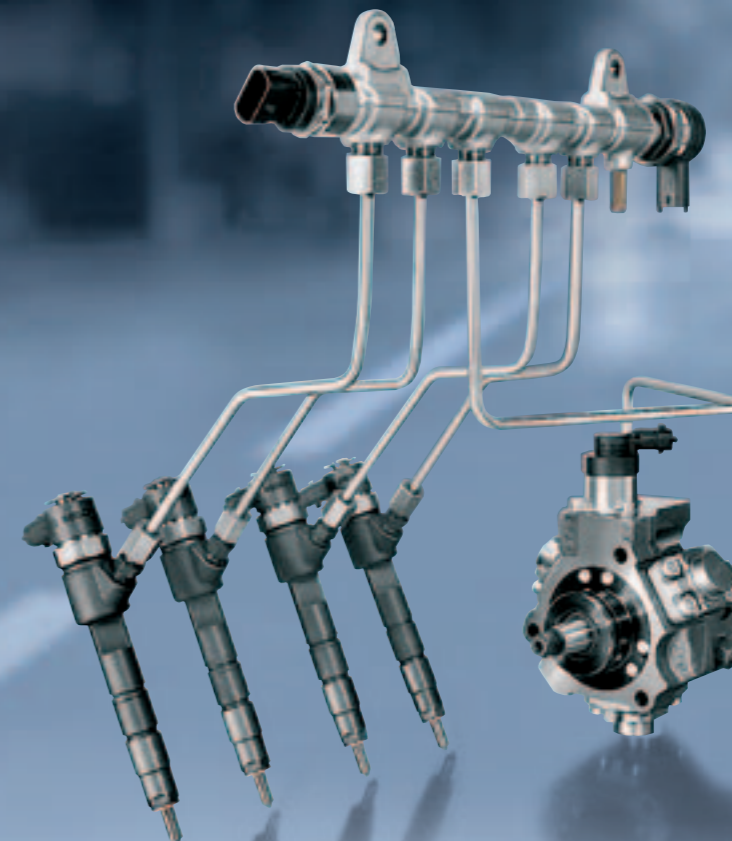

2012 | 2013

**Dieseinspritzung  
Diesel Fuel Injection  
Systèmes d'injection Diesel  
Sistemi di iniezione Diesel  
Inyección Diesel**

**2012 | 2013**



**BOSCH**

☎ 1 987 720 018/201204

AA/MK12 - 04.2012 - int

© 2012 Robert Bosch GmbH  
Automotive Aftermarket  
Postfach 41 09 60  
76225 Karlsruhe

Token fee: € 10,00

www.bosch.de/aa

Editorial closing: 15. 02. 2012

Subject to change without  
notice. Please direct questions  
and comments to our  
Authorized Representative in  
your country. This edition  
supersedes all previous  
editions.



**BOSCH**



**BOSCH**



4 047024 069954



de

Bosch-Diesel-Einspritztechnik – höchste Qualität vom weltweit führenden Zulieferer für Diesel-Erstausrüstung.

Ob Diesel-Neuware oder Bosch eXchange-Erzeugnisse/Original Werksaustausch, Bosch hat für alles die passende Lösung.

en

Bosch Diesel injection technology – the highest quality from the world's leading supplier of original equipment Diesel systems.

Whether it is new Diesel products or Bosch eXchange products/ original factory remanufacturing, Bosch has the right solution every time.

fr

Systèmes d'injection Diesel Bosch – Tout le savoir-faire du plus important fournisseur mondial d'équipements Diesel de première monte.

Pièces neuves ou pièces d'échange standard/ Bosch eXchange, Bosch propose une solution adaptée à tous les cas.

it

Sistemi di iniezione Diesel Bosch – know-how dal fornitore di sistemi iniezione Diesel leader a livello mondiale per il primo equipaggiamento Diesel.

Sia che si tratti di componenti nuovi, sia che si tratti di componenti revisionati del programma Bosch eXchange, Bosch ha la soluzione adatta per ogni esigenza.

es

Inyección Diesel Bosch – Los conocimientos y la experiencia del principal proveedor de equipos Diesel de origen del mundo.

Tanto si se trata de mercancía nueva como de componentes originales reacondicionados del programa Bosch eXchange, Bosch tiene siempre la solución idónea.

pt

Sistemas de injeção Diesel Bosch - a máxima qualidade do fornecedor líder mundial de equipamento original diesel. Quer se trate de produtos novos Diesel ou produtos Bosch eXchange/produtos originais reconstruídos em fábrica, a Bosch tem sempre a solução adequada.

sv

Bosch Diesel-insprutningsteknik – högsta kvalitet från den världsledande leverantören av förstahandsutrustning för Diesel.

Vare sig det gäller nya Diesel-artiklar eller Bosch eXchange-produkter/originalfabriksbyte, har Bosch alltid den passande lösningen för alla.

fi

Bosch-Diesel-ruiskutusteknologiaa - huippulaatua maailman johtavalta Diesel-varusteiden alkuperäistoimittajalta.

Uudet dieselosat tai Bosch eXchange-tuotteet/ alkuperäisvaihto-osat, Boschilla on sopiva ratkaisu joka kohteeseen.

pl

Technika układów wtryskowych firmy Bosch - najwyższa jakość od czołowego na świecie dostawcy wyposażenia seryjnego do silników wysokoprężnych.

Pytanie czy stosować do silników Diesla produkt nowy czy też produkty Bosch eXchange/originalna wymiana fabryczna. Bosch ma rozwiązania pasujące do wszystkiego.

ru

Система впрыска дизельного топлива Bosch - максимальное качество от ведущего во всем мире поставщика первичного дизельного оборудования.

Неважно, новые дизельные товары или изделия, возвращаемые в рамках программы Bosch eXchange/ оригинальной замены на заводе, Bosch для всех имеет подходящее решение.

de

**WOK** Für Fahrzeuge mit Wegfahrsperr, ohne Klimaanlage

**WW** Wahlweise

**WZT** Für Fahrzeuge mit Wegfahrsperr, Freischaltung über Zündschlüssel (Transpondersystem)

**X10** Für Zylinder 1

**X56** Für Zylinder 2 - 6  
1 Mit Nadelbewegungsfühler



Pkw



Nkw



Land- oder Baumaschine



Stationärmotor / Einbaumotor



Hubraum in l



Motorleistung in kW



Motortyp



Zylinderzahl



Exportland



Datum / Einbauzeitraum



Sonderfälle



Information / Erläuterung



Bestellnummer



Austauschnummer



Pfeil-N



Düsenhalterkombination



Dichtring Zylinderkopf/ Wärmeschutzscheibe DHK



Dichtring Leckölanschluss DHK



O-Ring



Common Rail injector



Common Rail Hochdruckpumpe



Verteilereinspritzpumpe VE und VR



Luftmassenmesser



Unit Injection System UIS (Pumpe-Düse-Einheit)



Unit Pump System UPS



Pumpe-Düse Einheit (PDE)



Denoxtronic-Fördermodul



Seitenverweis

# Inhalt Contents Contenu Contenuto Contenido Conteúdo Innehåll Sisältö Spis treści Содержание

Angebot Offer Offre Offerta Oferta Proposta Offert Tarjous Oferta Ассортимент

Bosch spare parts – Original equipment quality

A2



Bosch eXchange – Original Bosch factory exchange

A4



Nozzle-and-holder assemblies: Conversion key

A12



Nozzle-and-holder assemblies: Cross-reference

A14



Sealing washers and thermal-protection discs

A16



Thermal protection for nozzles

A17

Verwendung Applications Affectations Impiego Aplicaciones  
 Utilização Användning Käyttö Zastosowanie Применение

B1.0

How to use this catalogue

B1.1

B 2-46	B 191-231	B 263-301	B 335-387	B 420-453	-	-	B 503-510	B 511	
B 47-174	B 232-260	B 302-332	B 388-416	B 454-459	B 460-466	B 467-502	-	B 512-524	
B 175-183	B 261	B 333	B 417-418	-	-	-	-	-	
B 184-190	B 262	B 334	B 419	-	-	-	-	-	

Gegenüberstellung Cross-reference Table de correspondance Comparazione Equivalencias  
 Comparação Jämförelse Vertailu Zamienniki Сопоставления

C 2



de

**Bosch-Dieseleinspritzung**  
Neuware

en

**Bosch Diesel injection**  
New products

fr

**Injection Diesel Bosch,**  
pièces neuves

it

**Iniezione Diesel Bosch**  
Componenti nuovi

es

**Inyección Diesel de Bosch**  
Producto nuevo

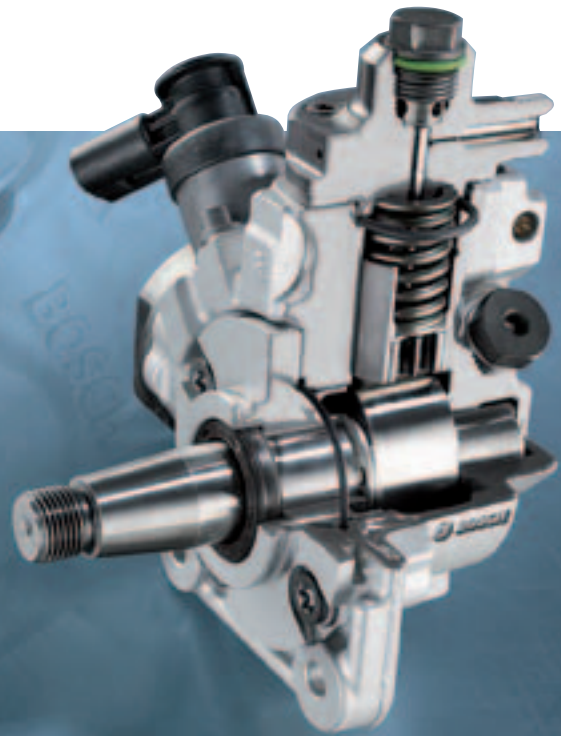

**Höchste Zuverlässigkeit durch Erstausrüstungsqualität**

- ▶ Moderne Bosch-Dieseleinspritzsysteme zeichnen sich durch einen hohen Einspritzdruck mit einer exakten Einspritzung aus. Dies erfordert Fertigungstoleranzen im Bereich von tausendstel Millimetern.
- ▶ Breites Programm des weltweit führenden Zulieferers für Diesel-Erstausrüstung
- ▶ Höchste Marktabdeckung für Pkw, leichte und schwere Nutzfahrzeuge, Landmaschinen und Sonderanwendungen
- ▶ Umfangreiche Produktinformationen, z. B. in den Katalogen für Bosch-Dieseleinspritzung und der Werkstatt-Software ESI[tronic]
- ▶ Schnelle Verfügbarkeit der Ersatzteile zur Markteinführung des Fahrzeuges
- ▶ Hohe Lieferfähigkeit für das gesamte Programm

**Maximum reliability thanks to original-equipment quality**

- ▶ Modern Bosch diesel injection systems feature a high injection pressure with high-precision injection. This requires production tolerances of thousandths of a millimeter.
- ▶ Broad range from the world's leading supplier of original-equipment diesel systems
- ▶ Maximum market coverage for passenger cars, light and heavy commercial vehicles, agricultural machinery and special applications
- ▶ Extensive product information, e.g. in the Bosch diesel-injection catalogs and the ESI[tronic] workshop software
- ▶ Rapid availability for newly launched vehicles
- ▶ Excellent delivery capability for the entire range

**Fiabilité extrême grâce à la qualité première monte**

- ▶ Les systèmes d'injection Diesel Bosch modernes se distinguent par leur pression d'injection élevée et leur précision, grâce à des tolérances de fabrication de l'ordre du millièème de millimètre.
- ▶ Vaste gamme du plus important fournisseur mondial d'équipements Diesel de première monte
- ▶ Couverture maximale du marché pour les véhicules particuliers, les utilitaires légers et lourds, les engins agricoles et les applications spéciales
- ▶ Nombreuses informations sur les produits par ex. dans les catalogues Bosch de systèmes d'injection Diesel et le logiciel d'atelier ESI[tronic]
- ▶ Rapide disponibilité des la mise sur le marché du véhicule
- ▶ Haute disponibilité de la totalité de la gamme

**Massima affidabilità grazie alla qualità di primo equipaggiamento**

- ▶ I moderni sistemi di iniezione diesel di Bosch si contraddistinguono per una elevata pressione ed una iniezione molto precisa. Ciò richiede tolleranze di fabbricazione minime che si aggirano nell'ordine dei millesimi di millimetro.
- ▶ Vasto programma dal fornitore di sistemi di iniezione Diesel leader a livello mondiale per il primo equipaggiamento
- ▶ Massima copertura di mercato per autovetture, veicoli commerciali leggeri e pesanti, macchine agricole e applicazioni speciali
- ▶ Informazioni dettagliate sui prodotti, ad es. nei cataloghi per sistemi di iniezione diesel Bosch e nel software ESI[tronic]
- ▶ Rapida disponibilità al momento dell'introduzione sul mercato di nuovi veicoli
- ▶ Elevata disponibilità di fornitura per l'intera gamma di prodotti

**Máxima fiabilidad gracias a la calidad propia de los equipos de origen**

- ▶ Los sistemas modernos de inyección Diesel de Bosch se caracterizan por una alta presión de inyección y con una inyección exacta. Para ello se requieren tolerancias de fabricación de milésimas de milímetros.
- ▶ Amplio programa del principal proveedor mundial de equipos de origen Diesel
- ▶ Máxima cobertura del mercado de turismos, furgonetas y camiones, máquinas agrícolas y aplicaciones especiales
- ▶ Información completa sobre los productos, p.ej. en los catálogos para inyección Diesel Bosch y en el software para talleres ESI[tronic]
- ▶ Disponibilidad rápida coincidente con el lanzamiento del vehículo al mercado
- ▶ Alta capacidad de suministro para todo el programa

pt

**Sistema de injeção Diesel Bosch**  
Produtos novos

sv

**Bosch Diesel-insprutning**  
Ny artikel

fi

**Bosch-Diesel-ruiskutus Uudet tuotteet**

pl

**Wtrysk paliwa do silników Diesla**  
Bosch Produkt nowy

ru

**Система впрыска дизельного топлива**  
Bosch Новый продукт



**Máxima confiabilidade devido à alta qualidade dos equipamentos de origem**

- ▶ Os sistemas modernos de injeção Diesel da Bosch caracterizam-se por uma injeção de alta pressão e com uma injeção exacta. Para a produção destes é requerido uma tolerância de milésimos de milímetros.
- ▶ Um amplo programa do principal fornecedor mundial de equipamentos diesel.
- ▶ Máxima cobertura do mercado de ligeiros, carrinhas, camiões, máquinas agrícolas e aplicações especiais.
- ▶ Informação completa sobre os produtos. Por exemplo nos catálogos de injeção da Bosch Diesel e no software ESI[tronic] para as lojas.
- ▶ Disponibilidade rápida, coincidente com o lançamento de veículos no mercado.
- ▶ Alta capacidade para fornecer todo o programa

**Maximal tillförlitlighet tack vare OEM-kvalitet**

- ▶ Moderna Bosch Dieselinsprutningssystem kännetecknas av högt insprutningstryck med exakt insprutning. Detta kräver tillverknings toleranser i storleksordningen tusendels millimetrar.
- ▶ Brett program från världens ledande leverantör av förstahandsutrustning för Diesel
- ▶ Högsta marknadstäckning för personbilar, lätta och tunga nyttofordon, jordbruksmaskiner och specialtillämpningar
- ▶ Omfattande produktinformation, t.ex. i katalogerna för Bosch dieselinsprutning och verkstadsmjukvaran ESI[tronic]
- ▶ Snabbt tillgängliga reservdelar inför fordonets marknadsintroduktion
- ▶ Hög leveranskapacitet för hela programmet

**Huippuluotettavaa alkuperäistoimittajan laatua**

- ▶ Moderneille Bosch-dieselruiskutusjärjestelmille on ominaista korkea ruiskutusaine ja hienosäädetty, tarkka ruiskutus. Tämä edellyttää valmistustoleransseilta millimetrin tuhannesosan tarkkuutta.
- ▶ Maailmanlaajuisesti johtavan diesel-alkuperäistoimittajan laaja valikoima
- ▶ Suurin markkinakattavuus: henkilöautot, kevyet ja raskaat hyötyajoneuvot, maatalous- ja muut erikoistyökoneet
- ▶ Kattavat tuotetiedotteet, esim.. Bosch-dieseesitteissä ja korjaamoille suunnatuissa ESI[tronic]-ohjelmisto-sovelluksissa
- ▶ Varaosat saatavana nopeasti, kun uusi ajoneuvomalli tulee markkinoille
- ▶ Taattu toimitusvarmuus kaikkein malleihin

**Największa niezawodność dzięki jakości wyposażenia seryjnego**

- ▶ Nowoczesne układy wtryskowe do silników wysokoprężnych Bosch charakteryzują się precyzyjnym wtryskiwaniem paliwa pod wysokim ciśnieniem. Wymaga to zachowania tolerancji produkowanych części w zakresie tysięcznych milimetra.
- ▶ Szeroki asortyment czołowego na świecie dostawcy wyposażenia seryjnego do silników wysokoprężnych
- ▶ Najwyższe pokrycie rynku części do samochodów osobowych, dostawczych, ciężarowych oraz maszyn rolniczych i zastosowań specjalnych
- ▶ Obszerne informacje o produkcie, np. w katalogach wtrysku paliwa do silników wysokoprężnych Bosch i w oprogramowaniu dla serwisów samochodowych ESI[tronic]
- ▶ Szybka dostępność części zamiennych przy wprowadzaniu pojazdu na rynek
- ▶ Sprawna dostawa całego asortymentu części

**Максимальная надежность благодаря качеству первичного оборудования**

- ▶ Современные системы впрыска дизельного топлива Bosch характеризуются высоким давлением впрыска с точным впрыском. Для этого необходимо соблюдать технологические допуски в пределах тысячных долей миллиметра.
- ▶ Широкая программа ведущего во всем мире поставщика первичного дизельного оборудования
- ▶ Максимальный охват рынка легковых, а также легких и тяжелых коммерческих автомобилей, с/х техники и специальных случаев применения
- ▶ Обширная информация о продуктах, например, в каталогах систем впрыска дизельного топлива Bosch и программном обеспечении для СТО ESI[tronic]
- ▶ Быстрая доступность запчастей при внедрении на рынок автомобиля
- ▶ Высокая способность поставки для всей программы

de

**Bosch eXchange/  
original Bosch-  
Werksaustausch**

en

**Bosch eXchange/  
Original Bosch  
factory exchange**

fr

**Bosch eXchange/  
l'échange standard  
d'origine Bosch**

it

**Bosch eXchange/  
il programma di  
componenti rige-  
nerati originali  
Bosch**

es

**Bosch eXchange/  
canje de fábrica de  
productos originales  
Bosch**



**Qualität ohne Kompromisse**

- ▶ Das umfassende Know-how des weltweit führenden Automobil-Zulieferers
- ▶ Instandsetzung ausschließlich in zertifizierten Bosch-Werken
- ▶ Weiterentwicklungen in der Erstausrüstung fließen mit in den Instandsetzungsprozess ein
- ▶ 100%iger Ersatz aller Verschleißteile und aller kritischen Bauteile
- ▶ Ausschließliche Verwendung von Original-Bosch-Ersatzteilen
- ▶ 100% Funktionsprüfung aller instand gesetzten Aggregate
- ▶ Umweltfreundlich durch Reduzierung der CO<sub>2</sub>-Emissionen und Einsparung von Ressourcen

**Quality without compromises**

- ▶ Comprehensive know-how from the world's leading automotive supplier
- ▶ Repairs are carried out exclusively in certified Bosch plants
- ▶ Advances in original equipment are incorporated into the repair process
- ▶ 100% replacement of all wearing parts and all critical components
- ▶ Exclusive use of original Bosch spare parts
- ▶ 100% functional testing of all repaired assemblies
- ▶ Environmentally friendly due to a reduction in CO<sub>2</sub> emissions and economical consumption of resources

**La qualité sans compromis**

- ▶ Le savoir-faire du premier équipementier automobile mondial
- ▶ Remise en état effectuée uniquement par des usines Bosch certifiées
- ▶ Les évolutions de la première monte rejaillissent sur les processus de remise en état
- ▶ Remplacement à 100% de toutes les pièces d'usure et composants critiques
- ▶ Utilisation exclusive de pièces de rechange d'origine Bosch
- ▶ Contrôle fonctionnel intégral de tous les équipements remis en état
- ▶ Ecologique grâce à la réduction des émissions de CO<sub>2</sub> et à l'économie de ressources

**Qualità senza compromessi**

- ▶ Vasto know-how dal fornitore leader a livello mondiale dell'industria automobilistica
- ▶ Rigenerazione dei componenti eseguita esclusivamente in stabilimenti Bosch certificati
- ▶ Il processo di rigenerazione tiene conto delle evoluzioni tecniche richieste dal primo equipaggiamento
- ▶ Sostituzione al 100% di tutti i componenti critici e dei componenti soggetti ad usura
- ▶ Uso esclusivo di ricambi originali Bosch per il processo di rigenerazione
- ▶ Controllo funzionale al 100% di tutti i gruppi rigenerati
- ▶ Soluzione ecologica grazie alla riduzione delle emissioni di CO<sub>2</sub> e alla salvaguardia delle risorse

**Calidad sin compromisos**

- ▶ Amplio conocimiento por parte del proveedor líder mundial de la industria del automóvil
- ▶ La reparación se realiza exclusivamente en fábricas Bosch certificadas
- ▶ Las mejoras introducida en los equipos de origen se incorporan también al proceso de reparación
- ▶ Se sustituye el 100% de las piezas sujetas a desgaste y de los componentes críticos
- ▶ Se emplean exclusivamente recambios originales Bosch
- ▶ El funcionamiento de todos los grupos reparados se comprueba al 100%
- ▶ Respeta el medio ambiente debido a la reducción de las emisiones de CO<sub>2</sub> y a la preservación de los recursos

pt

**Bosch eXchange/  
Recondicionamento  
de fábrica de produtos  
originais Bosch**

sv

**Bosch eXchange/  
Bosch original-  
fabriksbyte**

fi

**Bosch eXchange/  
alkuperäiset Bosch-  
tehdasvaihto-osat**

pl

**Bosch eXchange/  
wymiana oryginal-  
nych części Bosch  
regenerowanych  
fabrycznie**

ru

**Bosch eXchange/  
замена  
оригинальными  
компонентами  
Bosch на заводе**

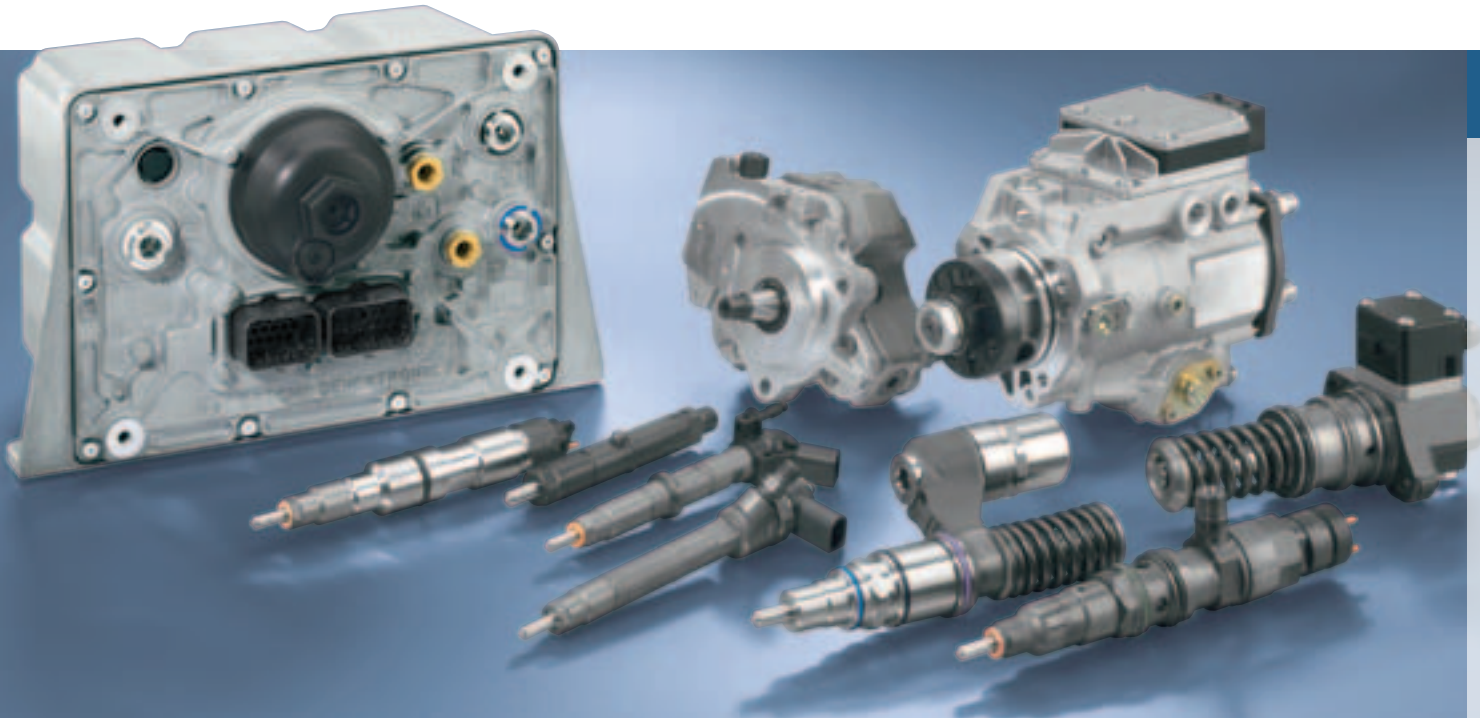

#### Qualidade sem compromissos

- ▶ O vasto know-how do fornecedor líder mundial da indústria automóvel
- ▶ Reparações realizadas exclusivamente em fábricas Bosch certificadas
- ▶ Os avanços no equipamento original são integrados no processo de reparação
- ▶ A substituição a 100% de todas as peças de desgaste e de todos os componentes críticos
- ▶ Utilização exclusiva de peças de reposição originais Bosch
- ▶ Verificação integral do funcionamento de todos os agregados reparados
- ▶ Ecológico graças à redução de emissões de CO<sub>2</sub> e poupança de recursos

#### Kvalitet utan kompromisser

- ▶ Det omfattande kunnandet hos världens ledande leverantör till bil-industrin
- ▶ Renovering endast i certifierade Bosch-fabriker
- ▶ Vidareutveckling i förstahandsutrustningen integreras i renoveringsprocessen
- ▶ 100 %-igt byte av alla sliddelar och alla kritiska komponenter
- ▶ Enbart Bosch originalreservdelar används
- ▶ 100 %-igt funktionstest av alla renoverade aggregat
- ▶ Miljövänlig tack vare reducering av CO<sub>2</sub>-emissioner och låg resursförbrukning

#### Tinkimätöntä laatua

- ▶ Maailmanlaajuisesti johtavan autotuotevarustajan kattavaa tietotaitoa
- ▶ Kunnostustyöt tehdään vain sertifioituissa Bosch-yksiköissä
- ▶ Alkuperäisvarustukseen tehdyt uudistukset otetaan huomioon kunnostusprosessissa
- ▶ Kuluvat osat korvataan 100 %, samoin kaikki kriittiset osat
- ▶ Varaosina käytetään vain alkuperäisiä Bosch-varaosia
- ▶ 100% toimivuuden tarkastus kaikille kunnostetuille komponenteille
- ▶ Ympäristöystävällinen, koska CO<sub>2</sub>-päästöt laskevat ja raaka-aine-resurssija säästetään

#### Jakość bez kompromisów

- ▶ Szeroka wiedza czołowego na świecie dostawcy części w branży motoryzacyjnej
- ▶ Naprawy wyłącznie w certyfikowanych zakładach Bosch
- ▶ Dalszy rozwój wyposażenia seryjnego przekłada się na proces naprawy
- ▶ Stuprocentowa wymiana wszystkich części zużytych oraz wszystkich elementów krytycznych
- ▶ Stosowanie wyłącznie oryginalnych części zamiennych Bosch
- ▶ Stuprocentowa kontrola działania wszystkich naprawianych agregatów
- ▶ Ekologiczny dzięki redukcji emisji CO<sub>2</sub> i oszczędzaniu zasobów naturalnych

#### Качество без компромиссов

- ▶ Широкое ноу-хау ведущего в мире поставщика автомобильного оборудования
- ▶ Ремонт только на сертифицированных заводах Bosch
- ▶ Усовершенствования первичного оборудования используются в процессе ремонта
- ▶ 100%-ная замена всех быстроизнашивающихся деталей и всех критических деталей
- ▶ Использование исключительно оригинальных запчастей Bosch
- ▶ 100%-ное функциональное испытание всех отремонтированных агрегатов
- ▶ Экологичность благодаря уменьшению выбросов CO<sub>2</sub> и экономии ресурсов

de

**Bosch eXchange – die optimale Reparaturalternative für jede Werkstatt – effizient, einfach, schnell!**

en

**Bosch eXchange – the optimum repair alternative for every workshop – efficient, simple, fast!**

fr

**Bosch eXchange – l'alternative optimale dans la réparation pour tout garagiste: efficace, simple, rapide!**

it

**Bosch eXchange – l'alternativa alla riparazione per ogni officina – efficiente, semplice, rapida!**

es

**Bosch eXchange – la alternativa de reparación óptima para cualquier taller – ¡eficiente, sencilla y rápida!**



#### Erstklassiger Service...

...durch umfangreiche Produktinformationen

- ▶ Katalog für Bosch-Dieseleinspritzung
- ▶ Rücknahmeliste Werksaustausch
- ▶ ESI Werkstatt-Software ESI[tronic]...durch einfache Altwarenabwicklung
- ▶ Übersichtliche Pfandklassen
- ▶ Eindeutige Rücknahmekriterien
- ▶ Einfaches Rücknahmesystem mit „Back in Box“

#### First-class service...

...thanks to comprehensive product information

- ▶ Bosch diesel-injection catalog
- ▶ Factory-exchange return list
- ▶ ESI[tronic] workshop software...simple processing of used products
- ▶ Clear reimbursement classes
- ▶ Clear return criteria
- ▶ Simple “back in box” return system

#### Un service de première classe... Ottima assistenza...

...grâce à de nombreuses informations produits

- ▶ Catalogue d'équipements d'injection Diesel Bosch
- ▶ Liste de reprise échange standard
- ▶ Logiciel d'atelier ESI [tronic]... grâce à un traitement simple des anciennes marchandises
- ▶ Des classes de consignes claires
- ▶ Des critères de reprise univoques
- ▶ Un système de reprise simple avec «Back in Box»

...grazie ad informazioni dettagliate sui prodotti

- ▶ Catalogo per sistemi iniezione diesel Bosch
- ▶ Elenco completo dei componenti restituibili nell'ambito del programma Bosch eXchange
- ▶ Software ESI per officine ESI[tronic] ...con una procedura snella e lineare
- ▶ Chiara definizione del valore dei contributi di rigenerazione
- ▶ Criteri univoci di restituzione
- ▶ Semplice sistema di restituzione secondo il principio «Back in Box»

#### Servicio de primera...

...gracias a amplias informaciones sobre el producto

- ▶ Catálogo para la inyección Diesel de Bosch
- ▶ Lista de devolución de reconstruido en fábrica
- ▶ Programa ESI para taller ESI[tronic]...mediante una tramitación sencilla de las piezas antiguas
- ▶ Clases de prendas claras
- ▶ Criterios de devolución claros
- ▶ Sencillo sistema devolución con «Back in Box»



pt

**Bosch eXchange – a alternativa de reparação ideal para qualquer oficina – eficaz, simples e rápida!**

sv

**Bosch eXchange – det optimala reparationsalternativet för alla verkstäder – effektivt, enkelt och snabbt!**

fi

**Bosch eXchange – optimaalinen kunnostusvaihtoehto jokaiseen korjaamoon – tehokas, helppo, nopea!**

pl

**Bosch eXchange – optymalna alternatywa do napraw dla każdego serwisu – skutecznie, łatwo, szybko!**

ru

**Bosch eXchange – оптимальная альтернатива ремонту для каждого СТО – эффективно, просто, быстро!**



## Bosch eXchange Core return criteria

**Bosch provides you with eXchange products in the highest quality.** Therefore, the used parts must be in an appropriate condition for the remanufacturing process.

Thus, all cores are not permitted to have certain criteria, which are listed below.

### Further exchange conditions:

- ▶ Product must be included in the valid Exchange Return List
- ▶ Part number must be legible

### The way to make core parts dealing easy:

- ▶ A few clear deposit values
- ▶ Clear core return criteria

- ▶ Easy and secure return Back in Box
- ▶ Quick handling through close sales net



**BOSCH**  
Invented for life

### Reasons for rejection:

#### ▶ Heavy corrosion

#### ▶ Assembly is incomplete

#### ▶ Assembly is disassembled

#### ▶ Mechanical damage

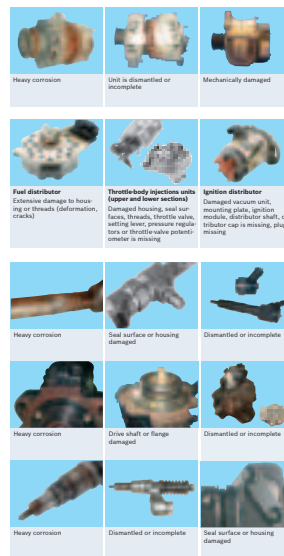

### Back in Box

**1. The new product is delivered**  
You get your new eXchange product from Bosch.

**2. The replacement parts are exchanged**  
You exchange the core for the remanufactured part.

**3. Back in Box returns**  
You send the core back in its original Bosch packaging.

**4. You get your deposit (collateral value)**  
Bosch pays you the collateral value of the eXchange product.

### Clean and easy collection of old cores from workshops:

- ▶ No damaged units in transit hands, no rejection of credits
- ▶ Easier identification of the cores speeds up the return process
- ▶ Environmentally friendly
- ▶ No dirt due to used parts

### Serviço de excelência...

- ...graças às informações detalhadas sobre os produtos
- ▶ Catálogo do sistema de injeção Diesel Bosch
- ▶ Lista de devoluções de produtos recondicionados em fábrica
- ▶ Software de oficina ESI[tronic]...mediante um tratamento simples das peças usadas
- ▶ Classes de reembolso claras
- ▶ Critérios de devolução claros
- ▶ Sistema de devolução simples com "Back in Box"

### Service av högsta klass...

- ...genom omfattande produktinformation
- ▶ Katalog för Bosch Dieselinnsprutning
- ▶ Återkallningslista fabriksbyte ESI[tronic]...med enkel hantering av gamla artiklar
- ▶ Överskådliga pantklasser
- ▶ Entydiga återkallningskriterier
- ▶ Enkelt återkallningssystem med "Back in Box"

### Ensiukkaista palvelua ...

- ...kattavilla tuotetiedotteilla
- ▶ Bosch-dieselruiskutus -esite
- ▶ Palautusosaluettelot tehdasvaihto-osille
- ▶ ESI -korjaamo-ohjelmisto ESI[tronic]...järkeistetty vanhojen osien käsittely
- ▶ Selkeä palautusosien luokittelu
- ▶ Yksiselitteiset palautuskriteerit
- ▶ Käytettyjen osien palautus "Back in Box"

### Serwis najwyższej klasy...

- ...dzięki obszernym informacjom o produkcie
- ▶ Katalog wtrysku paliwa do silników wysokoprężnych Bosch
- ▶ Dostępny wykaz części podlegających zwrotowi
- ▶ Oprogramowanie dla serwisów samochodowych ESI[tronic]... ułatwia identyfikację zwracanych zużytych części
- ▶ Przejrzyste wartości kosztu wymiany
- ▶ Jednoznaczne kryteria zwrotów
- ▶ Prosty system zwrotów „Back in Box“

### Первоклассный сервис...

- ...за счет всеобъемлющей информации о продукции
- ▶ Каталог системы впрыска дизельного топлива Bosch
- ▶ Список возврата при замене на заводе
- ▶ Программное обеспечение для СТО ESI ESI[tronic]... за счет простой обработки бывших в употреблении деталей
- ▶ Легко обозримые классы залога
- ▶ Однозначные критерии возврата
- ▶ Простая система возврата по принципу "Back in Box"

de

## Rücknahmebedingungen für Dieselkomponenten

en

## Return conditions for diesel components

fr

## Conditions de reprise des composants Diesel

it

## Condizioni per la restituzione dei componenti diesel

es

## Condiciones de readmisión para componentes Diesel



- ▶ Günstiger Preis für eine zeitwertgerechte Reparatur
- ▶ Schnelle Schadensbehebung
- ▶ Kalkulierbare Reparaturzeit
- ▶ Keine Investition in teure Komponenten-Prüftechnik
- ▶ Hohe Marktabdeckung und breites Typenspektrum mit ständiger Programmaktualisierung
- ▶ Keine Entsorgungsprobleme für Altteile

### Rücknahmebedingungen

Rücknahmefähig im Rahmen des Bosch-eXchange-Programms sind alle Dieselkomponenten, sofern sie nicht eines oder mehrere der folgenden Merkmale aufweisen:

- ▶ Starke Korrosion
  - ▶ Zerlegt
  - ▶ Beschädigte Dichtflächen
  - ▶ Mechanische Beschädigung
  - ▶ Verfärbung an Antriebswelle durch Überhitzung
  - ▶ Nicht „Back in Box“
  - ▶ Schutzkappen nicht aufgezogen
- Die werkseitige Prüfung entscheidet über die Tauschfähigkeit nach den oben genannten Richtlinien. Motoranbauteile und Befestigungsschrauben sind nicht Teil des Bosch-eXchange-Programms. Sie müssen abgeschraubt und sollten wiederverwendet werden.

- ▶ Economical prices for repairs based on current value
- ▶ Rapid elimination of damage
- ▶ Calculable repair time
- ▶ No investment in expensive component testing equipment
- ▶ High market coverage and broad range of types, with are constantly updated
- ▶ No disposal problems for used parts

### Return conditions

Under the Bosch eXchange program, all diesel components can be returned unless they exhibit one or more of the following features:

- ▶ Severe corrosion
  - ▶ Dismantled
  - ▶ Damaged sealing surfaces
  - ▶ Mechanical damage
  - ▶ Discoloration of the drive shaft due to overheating
  - ▶ Not "Back in Box"
  - ▶ Protective caps not fitted
- The factory inspection determines whether products are suitable for exchange based on the above guidelines. Engine-mounting parts and fixing bolts are not covered by the Bosch eXchange program. These must be unscrewed and should be reused.

- ▶ Un prix avantageux pour une réparation adaptée à la valeur du véhicule
- ▶ Dépannage rapide
- ▶ Temps de réparation prévisible
- ▶ Pas d'investissement dans de coûteux systèmes de contrôle des composants
- ▶ Une forte couverture du marché et une vaste gamme, avec une permanente remise à jour
- ▶ Pas de problèmes d'élimination des anciennes pièces

### Conditions de reprise

Peuvent être repris, dans le cadre de la gamme Bosch eXchange, tous les composants Diesel, dans la mesure où ils ne présentent pas l'un ou plusieurs des critères suivants :

- ▶ Forte corrosion
- ▶ Démonté
- ▶ Surfaces d'étanchéité endommagées
- ▶ Endommagement mécanique
- ▶ Arbre d'entraînement bleui par la surchauffe
- ▶ Pas «Back in Box»
- ▶ Capuchons de protection manquants en place

Le service de contrôle de l'usine décide si l'échange est possible en fonction des critères mentionnés ci-dessus. Les pièces rapportées du moteur et les vis de fixation ne font pas partie de la gamme Bosch eXchange. Elles doivent être dévissées et réutilisées.

- ▶ Prezzo conveniente per una riparazione in linea con il valore attuale del veicolo
- ▶ Rapida riparazione del veicolo
- ▶ Tempi di riparazione facilmente quantificabili
- ▶ Non sono richiesti grandi investimenti in attrezzature per il controllo dei componenti
- ▶ Elevata copertura del mercato, ampia gamma di prodotti e aggiornamenti costanti del programma
- ▶ Nessun problema di smaltimento dei componenti usati

### Condizioni generali di restituzione

Nell'ambito del programma Bosch eXchange possono essere restituiti i componenti diesel, a patto che non presentino una o più delle seguenti caratteristiche:

- ▶ Marcata corrosione
- ▶ Componente smontato
- ▶ Superfici di tenuta danneggiate
- ▶ Danni meccanici
- ▶ Colorazione blu dell'albero di comando dovuta al surriscaldamento
- ▶ Componente restituito senza la scatola originale
- ▶ Cappucci di protezione mancanti

Un attento controllo determinerà se il componente può essere restituito in base ai criteri menzionati sopra. Parti applicate sul motore e viti di fissaggio non sono comprese nel programma Bosch eXchange. Esse vanno pertanto smontate e se ne consiglia il riutilizzo.

- ▶ Precio económico para una reparación acorde con el valor actual del vehículo
- ▶ Subsanación rápida de los daños
- ▶ Tiempo de reparación calculable
- ▶ No son necesarias inversiones en sistemas para la comprobación de componentes
- ▶ Alto grado de cobertura del mercado y amplio espectro de modelos, con una actualización constante del programa
- ▶ Sin problemas de eliminación de piezas viejas

### Condiciones para la readmisión

Se pueden readmitir en el marco del programa Bosch eXchange todos los componentes Diesel, siempre y cuando no presenten una varias de las siguientes características:

- ▶ Fuerte corrosión
  - ▶ Componente desarmado
  - ▶ Superficies de junta dañadas
  - ▶ Daños mecánicos
  - ▶ Coloración del árbol de accionamiento por sobrecalentamiento
  - ▶ Sin envase para «Back in Box»
  - ▶ Sin caperuzas protectoras
- La comprobación de fábrica decide sobre la susceptibilidad de canje según las normas arriba citadas. Las piezas de montaje exterior del motor y los tornillos de fijación no son parte del programa Bosch eXchange. Se tienen que desatornillar y volver a utilizar.

pt

## Condições para a devolução de componentes Diesel

- ▶ Preço económico para uma reparação de acordo com o valor actual do veículo
- ▶ Eliminação rápida de danos
- ▶ Tempo de reparação facilmente quantificável
- ▶ Sem necessidade de investimentos em dispendiosos equipamentos de teste de componentes
- ▶ Elevado grau de cobertura de mercado e amplo espectro de modelos com uma actualização constante do programa
- ▶ Sem problemas de eliminação de peças usadas

### Condições de devolução

No âmbito do programa Bosch eXchange, é possível devolver todos os componentes Diesel, desde que estes não apresentem um ou vários dos seguintes sinais:

- ▶ Forte corrosão
- ▶ Desarmado
- ▶ Superfícies de vedação danificadas
- ▶ Danos mecânicos
- ▶ Descoloração no eixo de accionamento devido a sobreaquecimento
- ▶ Sem embalagem para "Back in Box"
- ▶ Sem capas de protecção

O serviço de verificação da fábrica determinará se o produto poderá ser substituído, de acordo com as directrizes acima referidas. As peças de montagem do motor e os parafusos de fixação não estão incluídos no programa Bosch eXchange. Têm de ser desapertados e reutilizados.

sv

## Återkallningsvillkor för Dieselkomponenter

- ▶ Bra pris för reparation anpassad till nuvarande marknadsvärde
- ▶ Snabb skadeavhjälpning
- ▶ Reparationstid som kan beräknas
- ▶ Ingen investering i dyr komponent-provningsteknik
- ▶ Hög marknadstäckning och brett modellspektrum med ständig programuppdatering
- ▶ Inga omhändertagningsproblem med gamla delar

### Återkallningsvillkor

Återkallningsbara enligt Bosch-eXchange-programmet är samtliga dieselkomponenter, om de inte uppvisar en eller flera av följande egenskaper:

- ▶ Kraftig korrosion
- ▶ Isärtagna
- ▶ Skadade tätningsytor
- ▶ Mekanisk skada
- ▶ Missfärgning på drivaxel på grund av överhettning
- ▶ Ej "Back in Box"
- ▶ Skyddskåpor sitter inte på

Kontrollen i fabrik avgör om byte kan göras enligt ovanstående direktiv. Motorpåbyggnadsdelar och fästskravar ingår inte i Bosch eXchange-programmet. De måste skruvas av och ska sättas tillbaka efteråt.

fi

## Dieselkomponenttien palautusehdot

- ▶ Korjaukset teknisesti ajan tasalla edulliseen hintaan
- ▶ Nopea vikojen korjaus
- ▶ Ennakoitavat korjausajat
- ▶ Ei vaadi investointeja kalliiseen testaustekniikkaan
- ▶ Suuri markkinakattavuus ja laaja tyyppivalikoima, aukottomat ohjelmapäivitykset
- ▶ Käytettyjen osien hävitysongelmia ei ole

### Palautusehdot

Palautuskelpoisia ovat Bosch-eXchange-ohjelmassa kaikki dieselkomponentit, jos niissä ei ole havaittu yhtä tai useampaa seuraavista puutteista tai vioista:

- ▶ voimakas korroosio
- ▶ osa on purettu
- ▶ vioittuneet tiivistyspinnat
- ▶ mekaaninen vika
- ▶ käyttöakseli väijäytynyt ylikuumentumisen vuoksi
- ▶ ei Back-in-Box -osa
- ▶ suojarahatut puuttuvat

Tehdas päättää tulotarkastuksessa, onko komponentti vaihtokelpoinen em. kriteerien perusteella. Mootoriin kiinnitettävät osat ja kiinnitysruuvit eivät kuulu Bosch-eXchange-ohjelmaan. Ne on irrotettava ja ne tulee käyttää uudelleen.

pl

## Warunki zwrotów komponentów do silników wysokoprężnych

- ▶ Przystępna cena naprawy, odpowiednia do aktualnej wartości pojazdu
- ▶ Szybkie usuwanie usterek
- ▶ Przewidywalny czas naprawy
- ▶ Brak wydatków na drogie urządzenia do testowania komponentów
- ▶ Wysokie pokrycie rynku i szeroka oferta typów z ciągłą aktualizacją asortymentu
- ▶ Brak problemu utylizacji zużytych części

### Warunki zwrotu części

W ramach programu Bosch eXchange wymianie podlegają takie komponenty do silników wysokoprężnych, które nie posiadają jednej lub kilku z poniższych kluczowych uszkodzeń:

- ▶ Silna korozja
- ▶ Rozmontowane
- ▶ Uszkodzone powierzchnie uszczelniające
- ▶ Uszkodzenia mechaniczne
- ▶ Przebarwienie wału napędowego w wyniku przegrzania
- ▶ Nie spakowane w "Back in Box"
- ▶ Nie założone kapturki ochronne

Kontrola fabryczna decyduje o możliwości wymiany według wymienionych wyżej wytycznych. Elementy silnika i śruby mocujące nie należą do asortymentu Bosch eXchange. Należy je odkręcić i użyć ponownie.

ru

## Условия возврата дизельных компонентов

- ▶ Выгодная цена для ремонта за реальную стоимость
- ▶ Быстрое устранение повреждений
- ▶ Расчетное время ремонта
- ▶ Без инвестиции в дорогое оборудование для испытания компонентов
- ▶ Большой охват рынка и широкий спектр типов с постоянной актуализацией программы
- ▶ Отсутствие проблем с утилизацией бывших в эксплуатации старых деталей

### Условия возврата

Возврату в рамках программы Bosch eXchange подвергаются все дизельные компоненты, если они не имеют одного или нескольких из следующих признаков:

- ▶ Сильная коррозия
- ▶ Разобранное состояние
- ▶ Поврежденная уплотнительная поверхность
- ▶ Механическое повреждение
- ▶ Изменение цвета приводного вала в результате перегрева
- ▶ Не принцип "Back in Box"
- ▶ Защитные колпачки не надеты

В результате заводского испытания принимается решение о возможности замены в соответствии с указанными выше правилами. Пристраиваемые к двигателю детали и крепежные винты не являются частью программы Bosch eXchange. Их необходимо открутить и использовать повторно.

de

**Informationen zum Bosch-Programm**

en

**Information about the Bosch Program**

fr

**Informations sur la gamme Bosch**

it

**Informazioni sul programma Bosch**

es

**Información sobre el programa Bosch**

pt

**Informações relativas ao programa Bosch**

sv

**Information om Bosch-programmet**

fi

**Tietoa ja tiedotteita Bosch-ohjelmaan**

pl

**Informacje dotyczące asortymentu Bosch**

ru

**Информация о программе Bosch**



**Erstklassiger Service ... durch umfangreiche Produktinformationen**

- ▶ Aktuelle Kataloge für das komplette Bosch-Programm inklusive eXchange
- ▶ Rücknahmeliste Bosch eXchange
- ▶ Technische Informationen, z. B. ESI[tronic]
- ▶ Technische Schulungen und Hotline

**First-class service ... thanks to extensive product information**

- ▶ Up-to-date catalogs for the complete Bosch range including eXchange
- ▶ Return list Bosch eXchange
- ▶ Technical information, e.g. ESI[tronic]
- ▶ Technical training and hotline

**Un service de première classe ... grâce à de nombreux informations produits**

- ▶ Des catalogues à jour pour la gamme Bosch complète y compris eXchange
- ▶ Liste de reprise Bosch eXchange
- ▶ Informations techniques par ex. ESI[tronic]
- ▶ Formations techniques et Hotline

**Ottima assistenza ... grazie ad informazioni dettagliate sui prodotti**

- ▶ Cataloghi aggiornati per tutti i programmi Bosch, incluso Bosch eXchange
- ▶ Elenco dei componenti Bosch eXchange restituibili
- ▶ Informazioni tecniche, ad es. ESI[tronic]
- ▶ Formazione tecnica e hotline

**Servicio de primera categoría ... con las más completa información sobre productos**

- ▶ Catálogos actuales para todo el programa Bosch, inclusive eXchange
- ▶ Lista de valoración Bosch eXchange
- ▶ Informaciones técnicas p.e. ESI[tronic]
- ▶ Cursos técnicos y línea directa

**Serviço de excelência ... graças às informações detalhadas sobre os produtos**

- ▶ Catálogos actuais para o programa Bosch completo, incluindo o eXchange
- ▶ Lista de devoluções Bosch eXchange
- ▶ Informações técnicas, p. ex. ESI[tronic]
- ▶ Formações técnicas e linha directa de assistência

**Service av högsta klass... genom omfattande produktinformation**

- ▶ Aktuella kataloger för hela Bosch-programmet inklusive eXchange
- ▶ Återkallningslista Bosch eXchange
- ▶ Teknisk information, t. ex. ESI[tronic]
- ▶ Tekniska kurser och servicetelefon

**Ensiluokkaista palvelua ... kattavien tuotetietojen ansiosta**

- ▶ Ajankohtaiset esitteet koko Bosch- ja eXchange-ohjelmaan
- ▶ Palautusosaluettelo Bosch eXchange
- ▶ Tekniset tiedotteet, esim. ESI[tronic]
- ▶ Tekninen koulutus ja hotline-palvelu

**Serwis najwyższej klasy ... dzięki obszernym informacjom o produkcie**

- ▶ Aktualne katalogi całego asortymentu Bosch wraz z eXchange
- ▶ Lista zwrotów Bosch eXchange
- ▶ Informacje techniczne, np. ESI[tronic]
- ▶ Szkolenia techniczne i infolinia Hotline

**Первоклассный сервис ... за счет всеобъемлющей информации о продукции**

- ▶ Актуальные каталоги для полной программы Bosch включая eXchange
- ▶ Список возврата Bosch eXchange
- ▶ Техническая информация, например, ESI[tronic]
- ▶ Технические курсы обучения и горячая линия

de

"Online"-Katalog  
für Kraftfahrzeug-  
Ausrüstung

en

"Online" Catalogue  
for Automotive Parts

fr

Catalogue »online«  
de pièces détachées  
et de rechange

it

Catalogo »online«  
per ricambi di  
automobili

es

Catálogo »online«  
de los componentes  
del automóvil

**75 Countries  
28 Languages**

# www.bosch-automotive-catalog.com

Einfacher und schneller  
Zugriff auf Kfz-  
Ausrüstungsdaten von  
Bosch.

Easy and quick access to  
vehicle application data  
from Bosch.

Accès facile et rapide  
aux données de rechange  
automobile Bosch.

Ricerca semplice e  
veloce dei dati Bosch di  
equipaggiamento veicoli.

Fácil y rápido acceso  
a la información de  
equipamiento Bosch para  
vehículos.

de

**Düsenhalter-kombinationen:**  
Umschlüssel-Hilfe

en

**Nozzle-and-holder assemblies:**  
Conversion key

fr

**Ensembles porte-injecteurs:**  
aide au changement de code

it

**Gruppi porta-polverizzatore:**  
schema ausiliare per l'identificazione

es

**Conjuntos inyectoros:**  
Ayuda de descodificación



**Im Zweifelsfall bitte beachten!**

Mit den Angaben der Typformel des Original-Bosch-Düsenhalters und dem angegebenen Einspritzdruck allein ist es nicht in allen Fällen möglich, auf die entsprechende Bestellnummer der (Austausch-)Düsenhalterkombination zu schließen. Der Unterschied liegt entweder in der eingebauten Düse (Beispiel ①) oder bei gleicher Düse im unterschiedlichen Düsenhalter (Beispiel ②). Daher ist es in diesen Fällen unbedingt erforderlich, die entsprechenden (Austausch-)Düsenhalterkombinationen über das Fahrzeug im Verwendungsteil festzustellen. Sollte das nicht möglich sein, muss in diesen Fällen die alte Düsenhalterkombination demontiert werden, um zur Düsenhalter-Typformel und dem Öffnungsdruck die eingebaute Düse zu ermitteln. In einigen Fällen kann man, bedingt durch Rationalmaßnahmen in der Fertigung, mehrere Düsenhalterkombinationen (Beispiel ③) ein und derselben Austausch-Düsenhalterkombination zuordnen. Nicht aufgeführte Bestellnummern sind nicht im Austausch-Programm enthalten.

**Please note the following points in case of doubt!**

Only the type designation of the original Bosch nozzle holder and the stated pressure do not always suffice to draw conclusions as to the corresponding part number of the exchange injector assembly injector. The difference lies either in the nozzle fitted (example ① below) or, if the nozzle is the same, in the different nozzle holder (example ② below). It is therefore essential in such cases to identify the corresponding exchange injector assemblies via the vehicle in the Application section of the catalog. If this is not possible, the old injector assembly must be disassembled, so as to determine the fitted nozzle in addition to the nozzle holder type designation and opening pressure. Due to the rationalization of production, several different injector assemblies may sometimes correspond to one and the same exchange injector assembly (example ③). Order numbers not listed are not included in the exchange program.

**En cas de doute, prière de tenir compte des remarques suivantes!**





Les données de la formule de type du porte-injecteur Bosch d'origine et de la pression d'ouverture voulue ne permettent pas toujours, à elles seules, de retrouver la référence correspondante du porte-injecteur avec injecteur en échange standard. La divergence résulte soit de l'injecteur intégré (exemple ①), soit du porte-injecteur différent pour le même injecteur (exemple ②). Dans ce cas, il est donc indispensable de déterminer, dans la section «Applications», le porte-injecteur avec injecteur d'échange standard par sélection du véhicule adéquat. Si cela n'est pas possible, l'ancien porte-injecteur avec injecteur doit être démonté afin de pouvoir déterminer l'injecteur intégré à partir de la formule de type du porte-injecteur et de la pression d'ouverture. Dans certains cas, il est possible, en raison de la rationalisation de la fabrication, d'affecter à plusieurs ensembles injecteur/porte-injecteur (exemple ③) un seul et même porte-injecteur avec injecteur d'échange standard. Les numéros de série non stipulés ne figurent pas dans la gamme d'échange standard.

**Da osservare in caso di dubbio!**

Solo con l'indicazione della sigla del portapolverizzatore originale Bosch e della pressione d'iniezione, non è sempre possibile risalire al numero di ordinazione del portapolverizzatore completo. La differenza è che in uno stesso corpo si possono montare polverizzatori differenti (Es. ①) oppure lo stesso polverizzatore può essere montato su corpi differenti (Es. ②). In questo caso è assolutamente necessario stabilire, attraverso il veicolo, il portapolverizzatore completo eXchange, nella parte dedicata all'uso. Qualora non fosse possibile, bisognerebbe smontare il portapolverizzatore vecchio per leggere la sigla del polverizzatore che servirà, insieme alla sigla del corpo ed alla pressione di apertura, a determinare il codice del prodotto eXchange. In alcuni casi è possibile che in base alla produzione, ad un codice eXchange vengano abbinati più di un portapolverizzatore completo (Es. ③). I numeri d'ordine non elencati non sono compresi nel programma di sostituzione.

**¡Recomendaciones en el caso de dudas!**

Aún disponiendo de las indicaciones existentes relacionadas con el tipo del portainyector original de Bosch, así como de la presión indicada, no es siempre posible deducir el número de pedido correspondiente del portainyector con inyector de intercambio. La diferencia se encuentra, o bien en el inyector montado (ejemplo ①) o, en el caso de inyector idéntico, en el diferente portainyector (ejemplo ②). Por ello, en estos casos es absolutamente imprescindible determinar el correspondiente portainyector con inyector de intercambio a través del vehículo en la sección «Aplicaciones». Si esto no es posible, en estos casos se deberá desmontar el portainyector con inyector, para así determinar el tipo de portainyector y la presión de abertura del inyector montado. En algunos casos, y debido a las medidas de racionalización llevadas a cabo en la producción, se puede asignar a varios portainyectores con inyector (ejemplo ③) un mismo portainyector con inyector de intercambio. Los números de pedido no indicados no están incluidos en el programa de sustitución.

	 Typ	 Typ	 bar		
①	KCA 30 S 44	DN 0 SD 261	115	0 432 217 131	<b>0 986 430 022</b>
	KCA 30 S 44	DN 0 SD 265	115	0 432 217 141	<b>0 986 430 025</b>
	KCA 30 S 44	DN 0 SD 220	115	0 432 217 142	<b>0 986 430 020</b>
②	KCE 27 S 3	DN 0 SD 310	115	0 432 217 253	<b>0 986 430 245</b>
	KCA 27 S 55	DN 0 SD 310	115	0 432 217 262	<b>0 986 430 246</b>
③	KDAL 80 S 47	DLLA 140 S 1003	200	0 432 231 680	<b>0 986 430 038</b>
	KDAL 80 S 42	DLLA 140 S 1003	200	0 432 231 764	<b>0 986 430 038</b>
	KDAL 80 S 14/14	DLLA 144 S 8200	175	0 432 231 797	<b>0 986 430 038</b>

de	en	fr	it	es
<b>Düsenhalter-kombinationen</b> Gegenüberstellung: Typformel Düsenhalter → Bosch eXchange	<b>Nozzle-and-holder assemblies</b> Cross-reference: Type formula nozzle-holder → Bosch eXchange	<b>Ensembles porte-injecteurs</b> Table de correspondance : Formule de type Porte-injecteur → Bosch eXchange	<b>Gruppi porta-polverizzatore</b> Confronto: Sigla portapolverizzatore → Bosch eXchange	<b>Conjuntos inyectoros</b> Equivalencias: Fórmula de tipo portainyector → Bosch eXchange



### KBAL ...

KBAL 100 S 52	DLLA 154 S 970	230...238	0 432 291 672	<b>0 986 430 336</b>
KBAL 116 S 66	DLLA 140 S 1054	265...273	0 432 291 635	<b>0 986 430 169</b>
KBAL 116 S 75	DLLA 148 S 1272	240...248	0 432 291 534	<b>0 986 430 301</b>
KBAL 65 S 13/13	DLLA 149 S 774	180...188	0 432 291 753	<b>0 986 430 067</b>
KBAL 96 P 35	DLLA 158 P 456/	260...270	0 432 191 655	<b>0 986 430 490</b>

### KBE ...

KBE 58 S 8	DN 0 SD 301	120...128	0 432 297 057	<b>0 986 430 532</b>
------------	-------------	-----------	---------------	----------------------

### KBEL ...

KBEL 100 P 123	DLLA 144 P 510	320...328	0 432 191 633	<b>0 986 430 352</b>
KBEL 100 P 202	DLLA 149 P 541	320...328	0 432 191 616	<b>0 986 430 348</b>
KBEL 100 P 64	DLLA 148 P 513	320...328	0 432 191 630	<b>0 986 430 349</b>
KBEL 109 P 11/13	DLLA 150 P 91/	305...313	0 432 192 881	<b>0 986 430 034</b>
KBEL 109 P 81	DSLA 145 P 300	240...252	0 432 193 845	<b>0 986 430 256</b>
KBEL 109 S 6/13	DLLA 150 S 853	255...263	0 432 292 881	<b>0 986 430 074</b>
KBEL 110 P 140	DSLA 134 P 604	240...252	0 432 193 757	<b>0 986 430 522</b>
KBEL 117 P 122	DLLA 150 P 555	260...268	0 432 191 611	<b>0 986 430 370</b>
KBEL 117 P 122	DLLA 152 P 571	260...268	0 432 191 612	<b>0 986 430 369</b>
KBEL 117 P 7/4	DLLA 148 P 149	260...268	0 432 191 788	<b>0 986 430 167</b>
KBEL 117 P 7/4	DLLA 150 P 110	265...273	0 432 191 815	<b>0 986 430 164</b>
KBEL 117 P 7/4	DLLA 150 P 177	260...268	0 432 191 771	<b>0 986 430 166</b>
KBEL 117 P 7/4	DLLA 150 P 178	260...268	0 432 191 770	<b>0 986 430 165</b>
KBEL 117 P 7/4	DLLA 150 P 31	275...283	0 432 191 863	<b>0 986 430 032</b>
KBEL 117 P 7/4	DLLA 150 P 52	265...277	0 432 191 848	<b>0 986 430 000</b>
KBEL 117 P 73	DLLA 152 P 285	260...268	0 432 191 737	<b>0 986 430 353</b>
KBEL 117 P 73	DLLA 152 P 313	260...268	0 432 191 730	<b>0 986 430 263</b>
KBEL 117 P 73	DLLA 152 P 339	260...268	0 432 191 715	<b>0 986 430 354</b>
KBEL 95 P 9/4	DLLA 143 P 40	275...283	0 432 191 854	<b>0 986 430 002</b>
KBEL 98 P 101	DLLA 145 P 466	245...253	0 432 191 658	<b>0 986 430 498</b>
KBEL 98 P 102	DLLA 145 P 286	255...267	0 432 191 529	<b>0 986 430 491</b>
KBEL 98 P 102	DLLA 145 P 433	260...268	0 432 191 669	<b>0 986 430 364</b>
KBEL 98 P 102	DLLA 145 P 504	260...268	0 432 191 634	<b>0 986 430 368</b>
KBEL 98 P 27	DLLA 143 P 93	255...263	0 432 191 825	<b>0 986 430 163</b>
KBEL 98 P 27	DLLA 143 P 96	265...273	0 432 191 822	<b>0 986 430 162</b>
KBEL 98 P 74	DLLA 145 P 328	260...268	0 432 191 724	<b>0 986 430 311</b>

### KCA ...

KCA 17 S 42	DN 0 SD 299	175...180	0 432 217 218	<b>0 986 430 240</b>
KCA 17 S 42	DN 0 SD 299 A	130...135	0 432 217 248	<b>0 986 430 244</b>
KCA 17 S 42	DN 0 SD 299 C	175...180	0 432 217 289	<b>0 986 430 375</b>
KCA 17 S 70	DN 0 SD 301	150...158	0 432 217 222	<b>0 986 430 249</b>
KCA 21 S 71	DN 0 SD 300	154...162	0 432 217 223	<b>0 986 430 241</b>
KCA 21 S 71	DN 0 SD 318	154...162	0 432 217 278	<b>0 986 430 302</b>
KCA 27 S 55	DN 0 SD 261	115...123	0 432 217 161	<b>0 986 430 172</b>
KCA 27 S 55	DN 0 SD 265	115...123	0 432 217 157	<b>0 986 430 197</b>
KCA 27 S 55	DN 0 SD 265	135...143	0 432 217 169	<b>0 986 430 173</b>
KCA 27 S 55	DN 0 SD 310	115...123	0 432 217 262	<b>0 986 430 246</b>
KCA 27 S 55	DN 0 SD 314	135...143	0 432 217 266	<b>0 986 430 247</b>
KCA 27 S 77	DN 0 SD 308	150...158	0 432 217 243	<b>0 986 430 206</b>
KCA 27 S 77	DN 0 SD 308	150...158	0 432 217 244	<b>0 986 430 206</b>
KCA 27 S 77/	DN 0 SD 308	150...158	0 432 217 283	<b>0 986 430 206</b>
KCA 27 S 77/	DN 0 SD 308	150...158	0 432 217 284	<b>0 986 430 206</b>
KCA 27 S 80	DN 0 SD 322	135...143	0 432 217 299	<b>0 986 430 449</b>

de

**Düsenhalter-  
kombinationen**

Gegenüberstellung:  
Typformel Düsen-  
halter → Bosch  
eXchange  
(Fortsetzung)

en

**Nozzle-and-holder  
assemblies**

Cross-reference:  
Type formula nozzle-  
holder → Bosch  
eXchange  
(continued)

fr

**Ensembles porte-  
injecteurs**

Table de correspon-  
dance : Formule de  
type Porte-injecteur  
→ Bosch eXchange  
(suite)

it





**Gruppi porta-  
polverizzatore**

Confronto: Sigla  
portapolverizzatore  
→ Bosch eXchange  
(seguito)

es

**Conjuntos inyectoros**

Equivalencias:  
Fórmula de tipo  
portainyector →  
Bosch eXchange  
(continuación)

 Typ	 Typ	 bar		
KCA 30 S 36/4	DN 0 SD 293	155...163	0 432 217 078	<b>0 986 430 080</b>
KCA 30 S 36/4	DN 0 SD 293	155...163	0 432 217 079	<b>0 986 430 080</b>
KCA 30 S 44	DN 0 SD 293	130...138	0 432 217 083	<b>0 986 430 081</b>
KCA 30 S 44	DN 0 SD 294	130...138	0 432 217 198	<b>0 986 430 189</b>
KCA 30 S 44	DN 0 SD 293	130...138	0 432 217 084	<b>0 986 430 081</b>
KCA 30 S 44	DN 0 SD 294	130...138	0 432 217 207	<b>0 986 430 189</b>
KCA 30 S 44	DN 0 SD 220	115...123	0 432 217 142	<b>0 986 430 020</b>
KCA 30 S 44	DN 0 SD 261	115...123	0 432 217 131	<b>0 986 430 022</b>
KCA 30 S 44	DN 0 SD 265	115...123	0 432 217 141	<b>0 986 430 025</b>
KCA 30 S 46	DN 0 SD 240/	115...123	0 432 217 125	<b>0 986 430 151</b>
KCA 30 S 79	DN 0 SD 297	130...138	0 432 217 239	<b>0 986 430 187</b>
KCA 30 S 79	DN 0 SD 297	155...163	0 432 217 241	<b>0 986 430 188</b>
KCA 30 S 79	DN 0 SD 297	130...138	0 432 217 271	<b>0 986 430 187</b>
KCA 30 S 79	DN 0 SD 297	130...138	0 432 217 240	<b>0 986 430 187</b>
KCA 30 S 79	DN 0 SD 297	155...163	0 432 217 242	<b>0 986 430 188</b>
KCA 30 S 79	DN 0 SD 297	130...138	0 432 217 272	<b>0 986 430 187</b>
KCA 30 S 94	DN 0 SD 320	130...138	0 432 217 293	<b>0 986 430 520</b>
KCA 30 SD 27/4	DN 0 SD 220	115...123	0 432 217 054	<b>0 986 430 020</b>

**KCE ...**

KCE 27 S 3	DN 0 SD 310	115...123	0 432 217 253	<b>0 986 430 245</b>
KCE 27 S 3	DN 0 SD 310	135...143	0 432 217 280	<b>0 986 430 388</b>
KCE 27 S 3	DN 0 SD 319	115...123	0 432 217 287	<b>0 986 430 307</b>
KCE 30 S 5	DN 0 SD 312	140...145	0 432 217 268	<b>0 986 430 381</b>





**KDAL ...**

KDAL 74 S 21/19	DLLA 142 S 792	200...210	0 432 231 823	<b>0 986 430 045</b>
KDAL 74 S 21/19	DLLA 150 S 187	200...210	0 432 231 887	<b>0 986 430 056</b>
KDAL 74 S 44	DLLA 134 S 1201	240...250	0 432 231 713	<b>0 986 430 210</b>
KDAL 74 S 44	DLLA 137 S 1157	200...210	0 432 231 724	<b>0 986 430 221</b>
KDAL 74 S 44	DLLA 142 S 1096	200...210	0 432 231 736	<b>0 986 430 178</b>
KDAL 74 S 44	DLLA 142 S 1173	200...210	0 432 231 722	<b>0 986 430 214</b>
KDAL 74 S 44	DLLA 142 S 1257	200...210	0 432 231 688	<b>0 986 430 221</b>
KDAL 80 S 14/14	DLLA 144 S 8200	175...183	0 432 231 797	<b>0 986 430 038</b>
KDAL 80 S 42	DLLA 136 S 1034	200...208	0 432 231 760	<b>0 986 430 168</b>
KDAL 80 S 42	DLLA 140 S 1003	200...208	0 432 231 764	<b>0 986 430 038</b>
KDAL 80 S 46	DLLA 134 S 1199	200...208	0 432 231 714	<b>0 986 430 211</b>
KDAL 80 S 46	DLLA 134 S 999	200...208	0 432 231 766	<b>0 986 430 133</b>
KDAL 80 S 46	DLLA 138 S 1191	200...208	0 432 231 717	<b>0 986 430 205</b>
KDAL 80 S 47	DLLA 134 S 1199	200...208	0 432 231 677	<b>0 986 430 211</b>
KDAL 80 S 47	DLLA 134 S 999	200...208	0 432 231 704	<b>0 986 430 133</b>
KDAL 80 S 47	DLLA 136 S 1034	200...208	0 432 231 703	<b>0 986 430 168</b>
KDAL 80 S 47	DLLA 138 S 1191	200...210	0 432 231 678	<b>0 986 430 205</b>
KDAL 80 S 47	DLLA 140 S 1003	200...208	0 432 231 680	<b>0 986 430 038</b>
KDAL 80 S 56	DLLA 136 S 943	235...243	0 432 231 778	<b>0 986 430 159</b>
KDAL 80 S 59	DLLA 131 S 1131	200...210	0 432 231 674	<b>0 986 430 508</b>
KDAL 80 S 59	DLLA 140 S 1003	175...185	0 432 231 673	<b>0 986 430 507</b>

**KDEL ...**

KDEL 109 P 62	DLLA 147 P 538	275...283	0 432 131 703	<b>0 986 430 390</b>
KDEL 75 P 16	DLLA 149 P 514	320...328	0 432 131 767	<b>0 986 430 347</b>
KDEL 77 P 59	DLLA 144 P 666	320...328	0 432 131 714	<b>0 986 430 511</b>
KDEL 80 P 33	DLLA 142 P 418	265...275	0 432 131 726	<b>0 986 430 326</b>
KDEL 80 P 33	DLLA 142 P 419	265...275	0 432 131 728	<b>0 986 430 327</b>
KDEL 80 P 33	DLLA 142 P 479	235...245	0 432 131 781	<b>0 986 430 361</b>
KDEL 82 P 12	DLLA 146 P 1311/	295...303	0 432 131 857	<b>0 986 430 321</b>



 Typ	 Typ	 bar		
KDEL 82 P 12	DLLA 152 P 452	320...328	0 432 131 788	<b>0 986 430 312</b>
KDEL 82 P 12	DLLA 152 P 531	320...328	0 432 131 760	<b>0 986 430 451</b>
KDEL 82 P 18	DLLA 134 P 422	260...270	0 432 131 798	<b>0 986 430 261</b>
KDEL 82 P 18	DLLA 134 P 430	260...270	0 432 131 794	<b>0 986 430 252</b>
KDEL 82 P 23	DLLA 134 P 180	265...273	0 432 131 820	<b>0 986 430 257</b>
KDEL 82 P 38	DSLA 154 P 492/	270...278	0 432 133 855	<b>0 986 430 313</b>
KDEL 82 P 7	DLLA 144 P 184	295...303	0 432 131 860	<b>0 986 430 196</b>
KDEL 82 P 7	DLLA 144 P 184/	280...294	0 432 131 667	<b>0 986 430 196</b>
KDEL 82 P 7	DLLA 144 P 184/	295...303	0 432 131 853	<b>0 986 430 196</b>
KDEL 82 P 7	DLLA 146 P 166	295...303	0 432 131 866	<b>0 986 430 228</b>
KDEL 82 P 7	DLLA 146 P 166/	295...303	0 432 131 831	<b>0 986 430 228</b>
KDEL 95 S 21	DLLA 160 S 1305	255...263	0 432 231 667	<b>0 986 430 330</b>
KDEL 97 P 10	DLLA 142 P 221	305...313	0 432 131 850	<b>0 986 430 031</b>
KDEL 97 P 10	DLLA 146 P 154-	305...313	0 432 131 871	<b>0 986 430 120</b>
KDEL 97 P 13	DLLA 155 P 230	305...313	0 432 131 846	<b>0 986 430 274</b>
KDEL 97 P 13	DLLA 155 P 306	265...273	0 432 131 825	<b>0 986 430 213</b>
KDEL 97 P 3	DLLA 142 P 87	305...313	0 432 131 878	<b>0 986 430 031</b>
KDEL 99 P 15	DLLA 155 P 307	260...268	0 432 131 824	<b>0 986 430 212</b>
KDEL 99 P 39	DLLA 150 P 573	285...293	0 432 131 751	<b>0 986 430 387</b>
KDEL 99 P 39	DLLA 152 P 496	315...323	0 432 131 773	<b>0 986 430 385</b>
KDEL 99 P 5	DLLA 144 P 144	305...313	0 432 131 873	<b>0 986 430 030</b>



de

Wärmeschutz  
für Düsen

en

Thermal protection  
for nozzles

fr

Protection thermique  
pour injecteurs

it

Isolamento termico  
per pulverizzatori

es

Protección antitérmica  
para inyectoros

### Wärmeschutzhülsen für Lochdüsen

Thermal-protection sleeves for hole-type nozzles

Douilles calorifuges pour injecteurs à trous

Bussola di isolamento termico per pulverizzatori a fori

Manguitos de protección antitérmica para inyectoros de orificio

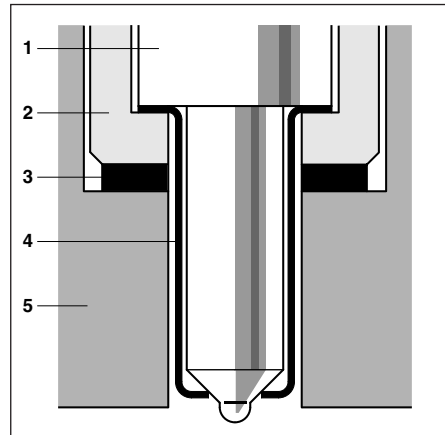
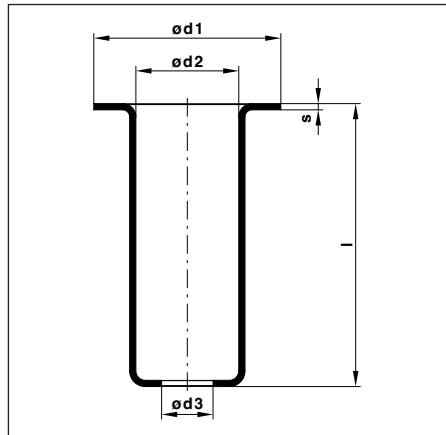

d1	d2	d3	l	s	⊕
mm	mm	mm	mm	mm	
13,6	9,5	6,2	25,0	0,5	<b>2 430 422 011</b>
15,5	9,5	6,2	24,6	0,5	<b>2 430 422 004</b>
16,5	9,5	6,2	25,0	0,5	<b>2 430 422 005</b>
21,0	9,3	9,0	17,3	2,0	<b>2 430 422 002</b>
14,9	7,20	6,9	17,4	1,5	<b>F 00Z W00 003</b>

#### 1 Lochdüse

Hole-type nozzle

Injecteur à trous

Polverizzatore a fori

Inyector de orificio

#### 2 Düsenspannmutter

Nozzle-retaining nut

Ecrou-raccord d'injecteur

Dado bloccapolverizzatore

Tuerca de sujeción de inyector

#### 3 Dichtscheibe

Sealing disc

Joint

Rosetta di tenuta

Junta

#### 4 Wärmeschutzhülse

Thermal-protection sleeve

Douille calorifuge

Bussola di isolamento termico

Manguito de protección antitérmica

#### 5 Zylinderkopf

Cylinder head

Culasse

Testata

Culata

### Dichtscheiben für Düsenhalter/CRI

mit Loch- und Zapfendüsen

Sealing discs for nozzle-holders/CRI

with hole-type and pintle nozzles

Joints pour porte-injecteurs/CRI

avec injecteurs à trous ou à téton

Rosette di tenuta per portapolverizzatori/

CRI con pulverizzatori a fori e polveriz-

zatori a pernetto

Juntas para portainyectoros/CRI

con inyectoros de orificio e inyectoros

de espiga

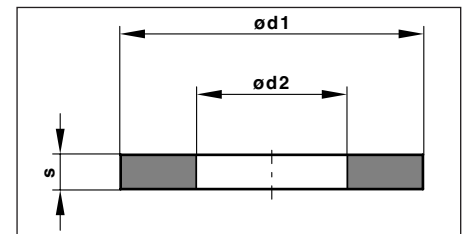

d1	d2	s	⊕
mm	mm	mm	
13,0	7,0	1,5	<b>F 00V P01 004</b>
13,0	7,0	2,5	<b>F 00V C17 505</b>
14,0	7,3	1,0	<b>F 002 C71 401</b>
14,0	7,3	2,0	<b>9 431 030 172</b>
14,0	7,3	3,8	<b>9 431 030 171</b>
14,4	7,0	1,5	<b>F 00R J02 175</b>
15,0	7,0	1,5	<b>F 00V C17 503</b>
15,0	7,0	1,5	<b>F 00R J01 453</b>
15,0	7,0	2,0	<b>F 00V C17 504</b>
15,0	7,0	2,0	<b>F 00R J01 086</b>
15,0	7,3	0,5	<b>2 430 105 048</b>
15,0	7,3	2,0	<b>2 430 105 035</b>
15,0	7,3	2,5	<b>2 430 105 042</b>
15,0	7,3	3,0	<b>2 430 105 043</b>
15,0	9,2	1,5	<b>2 430 105 026</b>
15,1	7,0	1,5	<b>2 430 105 049</b>
15,5	9,3	2,0	<b>2 430 105 023</b>
16,0	7,8	1,3	<b>2 430 105 057</b>
16,0	7,8	1,5	<b>2 430 105 055</b>
18,0	11,5	1,5	<b>F 002 C71 402</b>
18,8	9,7	2,0	<b>2 430 105 020</b>
19,3	7,3	2,0	<b>9 432 030 111</b>
19,3	9,7	1,6	<b>2 430 100 048</b>
19,3	9,7	2,0	<b>2 439 105 020</b>
19,3	14,3	2,0	<b>2 430 105 012</b>
19,3	14,3	2,0	<b>9 431 030 161</b>
20,4	15,7	2,0	<b>2 430 105 010</b>
21,0	17,2	1,5	<b>2 430 105 045</b>
21,1	17,4	2,3	<b>2 430 105 044</b>
21,5	15,7	2,0	<b>2 430 105 011</b>
24,0	18,2	2,0	<b>1 410 105 005</b>
24,5	16,6	2,0	<b>9 431 030 119</b>
25,9	22,2	1,5	<b>2 430 105 027</b>
35,0	28,0	1,0	<b>3 410 105 603</b>

de

**Wärmeschutz für Düsen**  
(Fortsetzung)

en

**Thermal protection for nozzles**  
(continued)

fr

**Protection thermique pour injecteurs**  
(suite)

it

**Isolamento termico per pulverizzatori**  
(seguito)

es

**Protección antitérmica para inyectoros**  
(continuación)



**Wärmeschutzscheiben für Drosselzapfendüsen**

**Thermal-protection discs for throttling pintle nozzles**

**Rondelles calorifuges pour injecteurs à téton et étranglement**

**Rosette di isolamento termico per pulverizzatori a pernetto strozzato**

**Arandelas de protección antitérmica para inyectoros de espiga con efecto estrangulador**

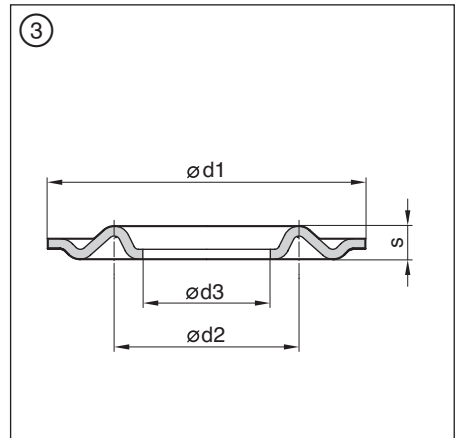
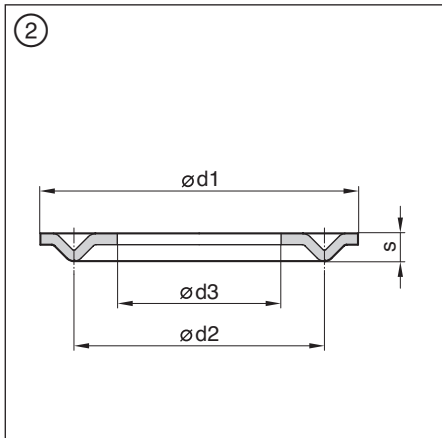
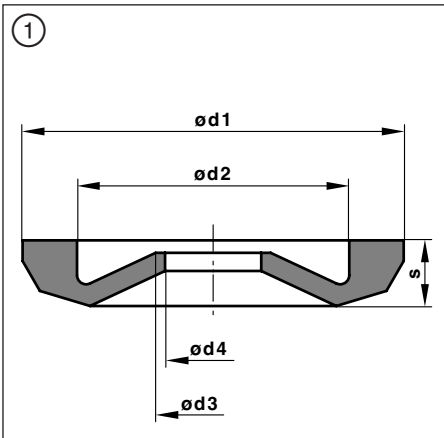
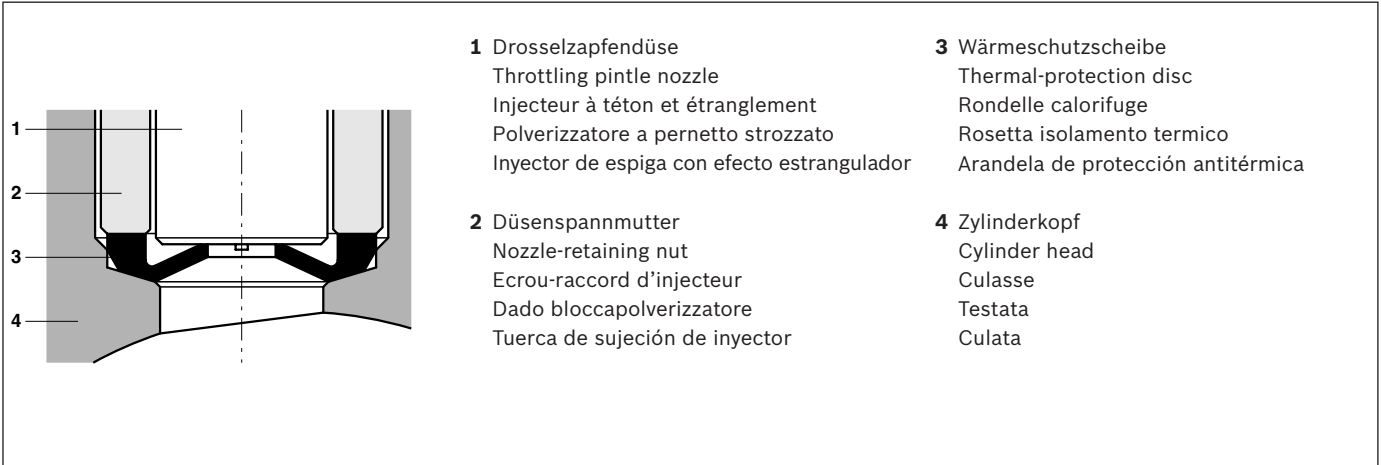

① ② ③

d1 mm	d2 mm	d3 mm	d4 mm	s mm	Ⓜ
11,20	5,50	3,00	-	1,35	<b>2 430 190 101</b>
13,80	8,00	5,50	-	1,35	<b>2 430 190 010</b>
13,80	10,00	6,50	-	1,35	<b>2 430 190 002</b>
20,10	14,50	11,70	10,00	2,60	<b>2 430 501 009</b>
20,10	14,60	8,80	7,70	2,60	<b>2 430 501 011</b>
20,30	14,50	-	5,30*	3,50	<b>1 410 501 072</b>

\* innen/inside/intérieur/interno/interior

de	en	fr	it	es
<p><b>Verwendungsteil</b></p> <p><b>Benutzerhinweise</b></p> <p>In diesem Katalog sind die Daten von Fahrzeugen, Motoren und Geräten für den europäischen Markt von Baujahr 1991 bis einschließlich 2011 erfasst. Diese wurden aus Hersteller- und Importeurangaben, aus Fahrzeuguntersuchungen sowie aus Unterlagen von Bosch nach bestem Wissen sorgfältig zusammengestellt und geben den Stand zum Zeitpunkt der Drucklegung wieder.</p> <p>Zwangsläufige Abweichungen durch länderspezifische technische Änderungen können nie ganz ausgeschlossen werden. Bosch kann daher insoweit nicht für die Vollständigkeit und Fehlerfreiheit der Daten haften. Für Irrtümer und Druckfehler, die zu Schäden am Eigentum oder Vermögen führen, haftet Bosch nur bei grob fahrlässiger Pflichtverletzung und bei Vorsatz für unmittelbare Schäden. Bei Personenschäden haftet Bosch auch bei leichter Fahrlässigkeit.</p>	<p><b>Applications</b></p> <p><b>Notes for users</b></p> <p>This catalog contains the data from the vehicles, engines, and equipment for the European market from year of manufacture 1991 up to and including the year 2011. This data has been assembled from information provided by manufacturers and importers, and taken from Bosch documentation, as well as from investigations made on vehicles. It has been compiled to the best of our knowledge and belief, and reflects the status at the date of going to print.</p> <p>Inevitable deviations due to country-specific technical changes can never be completely excluded. Therefore, Bosch in this respect cannot be responsible for the completeness and accuracy of the data. For mistakes and misprint, which lead to damage of property or fortune, Bosch is responsible only in case of grossly negligent violation of duties and in case of intention for direct damage. In case of personal injury, Bosch is also liable concerning slight negligence.</p>	<p><b>Affectations</b></p> <p><b>A l'attention de l'utilisateur</b></p> <p>Le présent catalogue mentionne les données spécifiques de véhicules, moteurs et appareils pour le marché européen depuis l'année de fabrication 1991 jusqu'au millésime 2011 inclus. Ces informations ont été rassemblées soigneusement et en toute impartialité à partir des indications des constructeurs et importateurs, des contrôles techniques des véhicules et de la documentation Bosch, et matérialisent le stade des connaissances au moment de la mise sous presse.</p> <p>Des écarts inévitables ne peuvent jamais être complètement exclus en raison des différences spécifiques à chaque pays. Bosch ne peut donc pas à cet égard être tenu responsable de l'exactitude des données. Pour des erreurs et fautes d'impression, qui causeraient des dégâts matériels, Bosch est responsable seulement en cas de violation de ses obligations par faute lourde intentionnelle en ce qui concerne les dommages matériels. En cas de dommages corporels, Bosch peut être également tenu pour responsable dans les cas de faute légère.</p>	<p><b>Impiego</b></p> <p><b>Avvertenze per la consultazione</b></p> <p>Nella seguente parte di catalogo sono contemplati veicoli, motori ed apparecchi a partire dall'anno di costruzione 1991 fino all'anno 2011. Tali informazioni sono state rilevate dalle documentazioni di Case Auto, Importatori, da verifiche eseguite sui veicoli, così come da documentazione Bosch.</p> <p>Eventuali discordanze, dovute a variazioni delle caratteristiche tecniche per specifici Paesi, non possono essere contemplate. Bosch non potrà quindi essere considerata responsabile per mancanze o inesattezze dei dati. Per eventuali danni a cose o danni patrimoniali, dovuti ad errori o refusi di stampa, Bosch è responsabile solo in caso di dolo o colpa grave. In caso di danni alla persona, Bosch è responsabile anche in caso di colpa meno grave.</p>	<p><b>Aplicación</b></p> <p><b>Instrucciones para el usuario</b></p> <p>Los datos de este catálogo para vehículos, motores y utensilios del mercado europeo comprenden los años de construcción desde 1991 hasta 2011 inclusive. Éstos son creados para la edición indicada sobre la base de documentos de Bosch, exámenes o inspecciones de vehículos así como datos de fabricantes e importadores.</p> <p>Las diferentes especificaciones técnicas propias de cada país nunca pueden ser excluidas completamente. Por lo tanto, Bosch en este aspecto, no puede ser responsable de la absoluta exactitud de los datos. En el caso de errores, incluidos los de imprenta, que generen daños ó pérdidas de la propiedad o posesiones, Bosch es responsable únicamente en los casos de violación negligente de sus obligaciones y en el supuesto de intención o dolo para el daño directo. Bosch está también obligado a responder en casos de injurias personales por negligencia.</p>
<p><b>pt</b></p> <p><b>Utilização</b></p> <p><b>Instruções para o utilizador</b></p> <p>Na parte do catálogo que se segue encontram-se registados veículos, motores e aparelhos até ao ano de 2011 inclusive e, retroactivamente, até ao ano de fabrico de 1991. Não nos responsabilizamos por quaisquer alterações do equipamento efectuadas pelos fabricantes do veículo, dos motores e dos aparelhos ou pelos fabricantes de produtos de outras marcas.</p> <p>Não é, de todo, possível excluir a existência de discrepâncias decorrentes de alterações técnicas específicas dos diversos países. Nesta medida, a Bosch não pode garantir que os dados sejam completos e isentos de erros. A Bosch não se responsabiliza por erros, omissões e erros de impressão, que conduzam a perdas e danos, excepto nos casos de danos resultantes directamente de negligência grave ou dolo. Em caso de danos pessoais, a Bosch responsabiliza também por danos resultantes de negligência simples.</p>	<p><b>sv</b></p> <p><b>Användningsdel</b></p> <p><b>Användarvägledning</b></p> <p>I denna katalog finns data angivna för fordon, motorer och apparater för den europeiska marknaden från årsmodell 1991 till och med 2011. Uppgifterna kommer från tillverkarna och importörerna, från fordonsundersökningar och från underlag från Bosch och är omsorgsfullt sammanställda enligt tillgänglig kunskap och anger läget vid tryckningstidpunkten.</p> <p>I vissa länder kan specifi ka avvikelser förekomma p. g. a. tekniska ändringar varför Bosch ej kan hållas ansvarig för ej komplett information. Vid fel som leder till direkt skada på egendom eller fordon, kan Bosch hållas ansvarig endast om grov oaktsamhet kan påvisas. Vid personskador kan Bosch hållas ansvarig om vårdslöshet kan påvisas.</p>	<p><b>fi</b></p> <p><b>Sovelluskohteet</b></p> <p><b>Esitteen käyttäjälle</b></p> <p>Oheiseen esitteeseen on koostettu ajoneuvo-, moottori- ja laitekohtaisia tietoja, jotka kattavat Euroopan maissa markkinoitua mallit v. m. 1991 lähtien – v. m. 2011 mukaan lukien. Tiedot on kerätty valikoiden valmistajien ja maahantuojien laatimista tiedoista, katsastusdokumenteista sekä Bosch-dokumenteista ja ne vastaavat painatusajankohdan tietämystasoa.</p> <p>Teknisiin muutoksiin tai poikkeamiin perustuvia maakohtaisia eroja ei voi täysin sulkea pois. Siksi Bosch ei voi ottaa vastuuta luettelon tietojen täydellisyydestä ja virheettömyydestä. Taloudellisiin menetyksiin mahdollisesti johtavien virheiden osalta Bosch on vastuussa ainoastaan karkeista huolimattomuusvirheistä johtuvista välittömistä vaurioista. Myös henkilövahingoissa Boschilla on vain vähäinen vastuu.</p>	<p><b>pl</b></p> <p><b>Zastosowanie</b></p> <p><b>Wskazówki dla użytkownika</b></p> <p>Katalog zawiera dane pojazdów, silników i urządzeń na rynek europejski od roku produkcji 1991 do 2011 włącznie. Zostały one starannie zestawione na podstawie danych producentów i importerów, badań pojazdów oraz dokumentacji firmy Bosch zgodnie z aktualnym stanem wiedzy w momencie oddania do druku.</p> <p>W katalogu mogą występować różnice w stosunku do poszczególnych pojazdów w związku ze specyficznymi dla poszczególnych krajów wersjami wyposażenia i specyfikacji technicznej. Bosch nie ponosi odpowiedzialności za kompletność i dokładność danych. Za błędy i nieścisłości w druku, które mogą prowadzić do szkód mienia Bosch jest odpowiedzialny jedynie w przypadkach rażącego zaniedbania obowiązków oraz w przypadku bezpośredniego zamiaru spowodowania szkód. Bosch jest odpowiedzialny za uszkodzenia ciała jedynie w przypadkach zaniedbania z własnej strony.</p>	<p><b>ru</b></p> <p><b>Применение</b></p> <p><b>Вниманию пользователей</b></p> <p>В настоящем каталоге приводятся данные по автомобилям, двигателям и прочему оборудованию на европейском рынке с 1991 по 2011 год выпуска включительно. Они были тщательно подобраны из информации, предоставленной производителями и импортерами, по результатам тестирования автомобилей, а также из документации компании Bosch и отражают состояние на момент подписания в печать. Неизбежные расхождения из-за специфических для каждой страны технических модификаций не могут быть полностью исключены. Поэтому компания Bosch не несет ответственность за полноту и точность предоставленных данных. В случае, если ошибки или опечатки привели к ущербу для собственности или повлекли материальные затраты, компания Bosch принимает на себя ответственность только если это является преднамеренным вредом или грубой небрежностью со стороны фирмы Bosch. Если по! страдало физическое лицо, фирма Bosch несет ответственность даже при допущении незначительной небрежности.</p>

**Hinweise zur Benutzung**

**B2 | ALFA ROMEO**



<b>ALFA ROMEO</b>						
<b>Alfetta</b>						
2.0 D Turbo	2,0	60-62	VM4HT/2	10.79-03.83	4	0 432 297 041
2.4 D Turbo	2,4	69-70	VM4HT 2.4	04.83-10.83	4	0 432 297 041
				11.83-12.84	4	0 432 297 047
<b>Giulietta</b>						
2.0 D Turbo	2,0	61	VM 4 HT	03.83-10.83	4	0 432 297 041
				11.83-04.85	4	0 432 297 047
<b>6</b>						
2.5 D Turbo	2,5	77	VM-HR 588 HT	06.83-02.87	5	0 432 297 047
<b>33 Berlina</b>						
1.8 D Turbo [905]	1,8	62	VM 82 A <M9>	09.86-12.89	4	0 432 297 047
D Turbo [907]	1,8	62	VM 96 A <M4>	02.90-10.94	3	0 432 297 047
<b>33 Sport Wagon</b>						
1.8 D Turbo [905]	1,8	62	VM 82 A <M9>	03.88-12.89	4	0 432 297 047
D Turbo [907]	1,8	62	VM 96 A <M4>	01.90-10.94	3	0 432 297 047
<b>75</b>						
2.0 TD	2,0	70	VM80A <M5>	05.85-05.86	4	0 432 297 041
				06.86-02.92	4	0 432 297 047
2.4 TD	2,4	81	VM81A <M6>	09.88-02.92	4	0 432 297 047
<b>90</b>						
2.4 D Turbo	2,4	81	VM 81 A	10.84-01.87	4	0 432 297 047
<b>145</b>						
1.9 TD [930 MY95]	1,9	66	AR 33601 <M7>; AR 67501 <M6>	04.94-11.96	4	0 432 217 211
TD [930 MY97]	1,9	66	AR 33601 <M5>; AR 67501 <M6>	11.96-05.98	4	0 432 217 211
<b>146</b>						
1.9 TD [930 MY95]	1,9	66	AR 33601 <U2 M6 CF2>; AR 67501 <U2 M5>	12.94-11.96	4	0 432 217 211
TD [930 MY97]	1,9	66	AR 33601 <M5>; AR 67501 <M6>	11.96-05.98	4	0 432 217 211
<b>155</b>						
1.9 TD [167 MY92]	1,9	66	AR 67501 <U6 M1>	04.93-04.96	4	0 432 217 211
TD [167 MY96]	1,9	66	AR 33601 <M1>	05.96-10.97	4	0 432 217 211
2.5 TD [167 MY92]	2,5	92	VM07B / VM31B <M2/M3>	04.93-04.96	4	0 432 217 222 0 986 430 249
					4	0 432 217 249 <sup>1</sup>
TD [167 MY96]	2,5	92	VM31B <M2>	05.96-10.97	4	0 432 217 222 0 986 430 249
					4	0 432 217 249 <sup>1</sup>
<b>164</b>						
2.5 D Turbo [164]	2,5	85	VM84A <M7>	06.87-09.92	4	0 432 297 047
		92	VM08B / VM32B <M8/M9>	09.92-10.98	4	0 432 217 222 0 986 430 249
					4	0 432 217 249 <sup>1</sup>

**AUDI**

<b>A3</b>						
1.9 TDI [8L1]	1,9	66	AGR	09.96-08.00	4	0 432 193 732
			ALH	08.97-06.01 AG	4	0 432 193 734 <sup>1</sup>
					4	0 432 193 702
					4	0 432 193 704 <sup>1</sup>
					4	0 432 193 693 <sup>1</sup>
					4	0 432 193 695
		81	AHF	01.97-08.00	4	0 432 193 744 <sup>1</sup>
			ASV	09.99-06.01	4	0 432 193 746
					4	0 432 193 592 <sup>1</sup>
					4	0 432 193 594
<b>A4</b>						
1.9 TDI [8D2; B5]	1,9	55	AFF	03.96-06.00	4	0 432 193 837 <sup>1</sup>
					4	0 432 193 838
		66	1Z	11.94-07.96	4	0 432 193 837 <sup>1</sup>
					4	0 432 193 838

- ① **Fahrzeugmarke**  
Hervorhebung der Hersteller im Graubalken
- ② **Fahrzeugmodell**  
Alphanumerisch aufsteigend
- ③ **Modelldetail**  
Besondere Fahrzeugmerkmale
- ④ **Hubraum**  
in l
- ⑤ **Motorleistung**  
in kW
- ⑥ **Motortyp**  
Siehe spezieller Hinweis in den Fahrzeugpapieren
- ⑦ **Export-Land**  
Gilt nur für spezielle Exportfahrzeuge
- ⑧ **Bildzeichen-Erläuterung**  
Siehe Katalogende
- ⑨ **Einbauzeitraum**
- ⑩ **Zylinder**  
Anzahl der im Motor vorhandenen Zylinder
- ⑪ **Sonderfall**  
Erläuterung siehe Katalogende
- ⑫ **Bestellnummer**

en

## How to use this catalogue

fr

## Consignes d'utilisation

it

## Istruzioni d'uso

es

## Indicaciones para la utilización

① <b>Manufacturer</b> indicated in bold print within gray bar	① <b>Marque de véhicule</b> Mise en avant des constructeurs sur fond gris	① <b>Marchio veicolo</b> Evidenziatura del produttore con banda grigia	① <b>Marca de vehículo</b> Fabricante destacado en gris
② <b>Model</b> In ascending alpha-numeric order	② <b>Modèle de véhicule</b> Classé par ordre alphanumé- rique croissant	② <b>Modello veicolo</b> In ordine alfanumerico crescente	② <b>Modelo de vehículo</b> Orden alfanumérico creciente
③ <b>Model details</b> Special vehicle features	③ <b>Détail du modèle</b> Caractéristiques particulières du véhicule	③ <b>Dettagli modello</b> Caratteristiche particolari veicolo	③ <b>Detalle del modelo</b> Características especiales del vehículo
④ <b>Engine capacity</b> in litres	④ <b>Cylindrée</b> en litres	④ <b>Cilindrata</b> in l	④ <b>Cilindrada</b> en l
⑤ <b>Engine output</b> in kW	⑤ <b>Puissance du moteur</b> en kW	⑤ <b>Potenza motore</b> in kW	⑤ <b>Potencia del motor</b> en kW
⑥ <b>Engine type</b> See details in service book	⑥ <b>Type de moteur</b> Voir la remarque spécifique dans les papier du véhicule	⑥ <b>Modello motore</b> Vedi nota speciale nei docu- menti del veicolo	⑦ <b>Tipo de motor</b> Ver indicación especial en la documentación del vehículo
⑦ <b>Export market</b> Only valid for export vehicles	⑦ <b>Pays d'exportation</b> Applicable uniquement aux véhicules spéciaux d'exportation	⑦ <b>Paese d'esportazione</b> Vale solo per veicoli d'esportazione speciali	⑦ <b>País de exportación</b> Indicación referente al país en que se utilizará el producto
⑧ <b>Icon explanations</b> See end of catalogue	⑧ <b>Signification des picto- grammes</b> En fin de catalogue	⑧ <b>Significati icone</b> Vedi fine catalogo	⑧ <b>Explicación de símbolo gráfico</b> Véase el final del catálogo
⑨ <b>Mounting duration</b>	⑨ <b>Période de montage</b>	⑨ <b>Periodo di montaggio</b>	⑨ <b>Periodo de montaje</b>
⑩ <b>Cylinders</b> Number of cylinders in engine	⑩ <b>Cylindres</b> Nombre de cylindres du moteur	⑩ <b>Cilindro</b> Numero dei cilindri nel motore	⑩ <b>Cilindros</b> Número de cilindros en el motor
⑪ <b>Special notes</b> For explanations see end of catalogue	⑪ <b>Particularités</b> Signification des abréviations en fin de catalogue	⑪ <b>Casi particolari</b> Per il significato, vedi fine catalogo	⑪ <b>Caso especial</b> Explicación, véase el final del catálogo
⑫ <b>Ordernumber</b>	⑫ <b>Référence</b>	⑫ <b>Numero di ordinazione</b>	⑫ <b>Referencia</b>

**Notas sobre a utilização**

**B2 | ALFA ROMEO**



<b>ALFA ROMEO</b>						
<b>Alfetta</b>						
2.0 D Turbo	2,0	60-62	VM4HT/2	10.79-03.83	4	0 432 297 041
2.4 D Turbo	2,4	69-70	VM4HT 2.4	04.83-10.83	4	0 432 297 041
				11.83-12.84	4	0 432 297 047
<b>Giulietta</b>						
2.0 D Turbo	2,0	61	VM 4 HT	03.83-10.83	4	0 432 297 041
				11.83-04.85	4	0 432 297 047
<b>6</b>						
2.5 D Turbo	2,5	77	VM-HR 588 HT	06.83-02.87	5	0 432 297 047
<b>33 Berlina</b>						
1.8 D Turbo [905]	1,8	62	VM 82 A <M9>	09.86-12.89	4	0 432 297 047
D Turbo [907]	1,8	62	VM 96 A <M4>	02.90-10.94	3	0 432 297 047
<b>33 Sport Wagon</b>						
1.8 D Turbo [905]	1,8	62	VM 82 A <M9>	03.88-12.89	4	0 432 297 047
D Turbo [907]	1,8	62	VM 96 A <M4>	01.90-10.94	3	0 432 297 047
<b>75</b>						
<b>2.0 TD</b>						
	2,0	70	VM80A <M5>	05.85-05.86	4	0 432 297 041
				06.86-02.92	4	0 432 297 047
2.4 TD	2,4	81	VM81A <M6>	09.88-02.92	4	0 432 297 047
<b>90</b>						
2.4 D Turbo	2,4	81	VM 81 A	10.84-01.87	4	0 432 297 047
<b>145</b>						
1.9 TD [930 MY95]	1,9	66	AR 33601 <M7>; AR 67501 <M6>	04.94-11.96	4	0 432 217 211
TD [930 MY97]	1,9	66	AR 33601 <M5>; AR 67501 <M6>	11.96-05.98	4	0 432 217 211
<b>146</b>						
1.9 TD [930 MY95]	1,9	66	AR 33601 <U2 M6 CF2>; AR 67501 <U2 M5>	12.94-11.96	4	0 432 217 211
TD [930 MY97]	1,9	66	AR 33601 <M5>; AR 67501 <M6>	11.96-05.98	4	0 432 217 211
<b>155</b>						
1.9 TD [167 MY92]	1,9	66	AR 67501 <U6 M1>	04.93-04.96	4	0 432 217 211
TD [167 MY96]	1,9	66	AR 33601 <M1>	05.96-10.97	4	0 432 217 211
2.5 TD [167 MY92]	2,5	92	VM07B / VM31B <M2/M3>	04.93-04.96	4	0 432 217 222 0 986 430 249
					4	0 432 217 249 <sup>1</sup>
TD [167 MY96]	2,5	92	VM31B <M2>	05.96-10.97	4	0 432 217 222 0 986 430 249
					4	0 432 217 249 <sup>1</sup>
<b>164</b>						
2.5 D Turbo [164]	2,5	85	VM84A <M7>	06.87-09.92	4	0 432 297 047
		92	VM08B / VM32B <M8/M9>	09.92-10.98	4	0 432 217 222 0 986 430 249
					4	0 432 217 249 <sup>1</sup>
<b>AUDI</b>						
<b>A3</b>						
1.9 TDI [8L1]	1,9	66	AGR	09.96-08.00	4	0 432 193 732
					4	0 432 193 734 <sup>1</sup>
			ALH	08.97-06.01 AG	4	0 432 193 702
					4	0 432 193 704 <sup>1</sup>
					4	0 432 193 693 <sup>1</sup>
					4	0 432 193 695
	81		AHF	01.97-08.00	4	0 432 193 744 <sup>1</sup>
					4	0 432 193 746
			ASV	09.99-06.01	4	0 432 193 592 <sup>1</sup>
					4	0 432 193 594
<b>A4</b>						
1.9 TDI [8D2; B5]	1,9	55	AFF	03.96-06.00	4	0 432 193 837 <sup>1</sup>
					4	0 432 193 838
	66	1Z		11.94-07.96	4	0 432 193 837 <sup>1</sup>
					4	0 432 193 838

Bosch Automotive Aftermarket

AUDI ►  
2010 | 2011

- ① **Marca do veículo**  
Fabricantes destacados na barra cinzenta
- ② **Modelo do veículo**  
Por ordem alfanumérica crescente
- ③ **Pormenor do modelo**  
Características especiais do veículo
- ④ **Cilindrada**  
em l
- ⑤ **Potência do motor**  
em kW
- ⑥ **Tipo de motor**  
Ver as indicações especiais constantes na documentação do veículo
- ⑦ **País de exportação**  
Apenas válido para veículos de exportação especiais
- ⑧ **Explicação do pictogramm**  
Explicação, ver final do catálogo
- ⑨ **Período da instalação**  
Primeira e última data da instalação referente ao modelo do veículo
- ⑩ **Número de cilindros**
- ⑪ **Caso especial**  
Explicação, ver final do catálogo
- ⑫ **Referência**



sv

## Bruksanvisning

nl

## Gebruiksaanwijzing

pl

Wskazówki dla  
użytkownika

ru

Указания по  
применению

## ① Fabrikat

Tillverkaren markerad i det grå fältet

## ② Fordonsmodell

Alfanumeriskt stigande

## ③ Modelldetalj

Speciella fordonskännetecken

## ④ Slagvolym

l

## ⑤ Motoreffekt

i kW

## ⑥ Motortyp

Se speciell anteckning i fordonshandlingarna

## ⑦ Exportland

Gäller för speciella exportfordon

## ⑧ Bildsymbolernas förklaring

Se förklaring i slutet av katalogen

## ⑨ Monteringsperiod

Monteringsperiod för respektive produkt

## ⑩ Cylinderantal

## ⑪ Specialfall

Se förklaring i slutet av katalogen

## ⑫ Artikelnummer

## ① Voertuigmerk

Accentuering van de fabrikanten in de grijze balk

## ② Voertuigmodel

Alfanumeriek oplopend

## ③ Modeldetail

Bijzondere voertuigkenmerken

## ④ Cilinderinhoud

in l

## ⑤ Motorvermogen

in kW

## ⑥ Motortype

Zie speciale opmerking in de voertuigpapieren

## ⑦ Exportland

Alleen geldig voor speciale exportvoertuigen

## ⑧ Toelichting van de symbolen

Toelichting zie einde van de catalogus

## ⑨ Inbouwperiode

Inbouwperiode van het betreffende product

## ⑩ Cilinder

## ⑪ Speciale gevallen

Toelichting zie einde van de catalogus

## ⑫ Referência

## ① Marka pojazdu

producent podany na szarym tle

## ② Model pojazdu

alfanumerycznie, rosnąco

## ③ Szczegóły modelu

cechy szczególne pojazdu

## ④ Pojemność skokowa

w l

## ⑤ Moc silnika

w kW

## ⑥ Typ silnika

patrz wskazówka w dokumentach pojazdu

## ⑦ Kraj eksportu

dotyczy tylko specjalnych pojazdów eksportowych

## ⑧ Objaśnienie symboli

Objaśnienie patrz koniec katalogu

## ⑨ Okres montażu

okres, w którym montowany był dany produkt

## ⑩ Liczba cylindrów

## ⑪ Przypadek szczególny

Objaśnienie patrz koniec katalogu

## ⑫ Nr katalogowy

## ① Марка автомобиля

Выделение производителей серыми полосками

## ② Модель автомобиля

В алфавитно-цифровом порядке

## ③ Особенность модели

Особые характеристики автомобиля

## ④ Объем двигателя

в литрах

## ⑤ Мощность двигателя

в кВт

## ⑥ Тип двигателя

См. специальное указание в документах на автомобиль

## ⑦ Страна-экспортер

Действительно только для специальных экспортных автомобилей

## ⑧ Разъяснение пиктограмм

См. разъяснения в конце каталога

## ⑨ Время установки.

Время установки соответствующего изделия

## ⑩ Количество цилиндров

## ⑪ Особые случаи

См. разъяснения в конце каталога

## ⑫ Номер для заказа



**ALFA ROMEO**

<b>6</b>						
2.5 D Turbo	2,5	77	VM-HR 588 HT	06.83-02.87	5	<b>0 432 297 047</b>
<b>33 Berlina</b>						
1.8 D Turbo [905]	1,8	62	VM 82 A <M9>	09.86-12.89	4	<b>0 432 297 047</b>
D Turbo [907]	1,8	62	VM 96 A <M4>	02.90-10.94	3	<b>0 432 297 047</b>
<b>33 Sport Wagon</b>						
1.8 D Turbo [905]	1,8	62	VM 82 A <M9>	03.88-12.89	4	<b>0 432 297 047</b>
D Turbo [907]	1,8	62	VM 96 A <M4>	01.90-10.94	3	<b>0 432 297 047</b>
<b>75</b>						
2.0 TD	2,0	70	VM80A <M5>	05.85-05.86 06.86-02.92	4	<b>0 432 297 041</b>
2.4 TD	2,4	81	VM81A <M6>	09.88-02.92	4	<b>0 432 297 047</b>
<b>90</b>						
2.4 D Turbo	2,4	81	VM 81 A	10.84-01.87	4	<b>0 432 297 047</b>
<b>145</b>						
1.9 TD [930 MY95]	1,9	66	AR 33601 <M7>; AR 67501 <M6>	04.94-11.96	4	<b>0 432 217 211</b>
TD [930 MY97]	1,9	66	AR 33601 <M5>; AR 67501 <M6>	11.96-05.98	4	<b>0 432 217 211</b>
<b>146</b>						
1.9 TD [930 MY95]	1,9	66	AR 33601 <U2 M6 CF2>; AR 67501 <U2 M5>	12.94-11.96	4	<b>0 432 217 211</b>
TD [930 MY97]	1,9	66	AR 33601 <M5>; AR 67501 <M6>	11.96-05.98	4	<b>0 432 217 211</b>
<b>155</b>						
1.9 TD [167 MY92]	1,9	66	AR 67501 <U6 M1>	04.93-04.96	4	<b>0 432 217 211</b>
TD [167 MY96]	1,9	66	AR 33601 <M1>	05.96-10.97	4	<b>0 432 217 211</b>
2.5 TD [167 MY92]	2,5	92	VM07B / VM31B <M2/M3>	04.93-04.96	4	<b>0 432 217 222 0 986 430 249</b>
					4	<b>0 432 217 249<sup>1</sup></b>
TD [167 MY96]	2,5	92	VM31B <M2>	05.96-10.97	4	<b>0 432 217 222 0 986 430 249</b>
					4	<b>0 432 217 249<sup>1</sup></b>
<b>164</b>						
2.5 D Turbo [164]	2,5	85	VM84A <M7>	06.87-09.92	4	<b>0 432 297 047</b>
		92	VM08B / VM32B <M8/M9>	09.92-10.98	4	<b>0 432 217 222 0 986 430 249</b>
					4	<b>0 432 217 249<sup>1</sup></b>

**AUDI**

<b>A3</b>						
1.9 TDI [8L1]	1,9	66	AGR	09.96-08.00	4	<b>0 432 193 732</b>
					4	<b>0 432 193 734<sup>1</sup></b>
			ALH	08.97-06.01 AG	4	<b>0 432 193 702</b>
					4	<b>0 432 193 704<sup>1</sup></b>
					4	<b>0 432 193 693<sup>1</sup></b>
					4	<b>0 432 193 695</b>
	81		AHF	01.97-08.00	4	<b>0 432 193 744<sup>1</sup></b>
					4	<b>0 432 193 746</b>
			ASV	09.99-06.01	4	<b>0 432 193 592<sup>1</sup></b>
					4	<b>0 432 193 594</b>
<b>A4</b>						
1.9 TDI [8D2; B5]	1,9	55	AFF	03.96-06.00	4	<b>0 432 193 837<sup>1</sup></b>
					4	<b>0 432 193 838</b>
		66	AHH	04.97-10.00	4	<b>0 432 193 702</b>
					4	<b>0 432 193 704<sup>1</sup></b>
			AHU	08.96-06.00	4	<b>0 432 193 837<sup>1</sup></b>
					4	<b>0 432 193 838</b>
			1Z	11.94-07.96	4	<b>0 432 193 837<sup>1</sup></b>
					4	<b>0 432 193 838</b>
TDI, TDI quattro [8D2; B5]	1,9	81	AFN	02.96-12.98	4	<b>0 432 193 744<sup>1</sup></b>
					4	<b>0 432 193 746</b>
				02.96-07.99	4	<b>0 432 193 744<sup>1</sup></b>
					4	<b>0 432 193 746</b>





<b>1.9</b> TDI, TDI quattro [8D2; B5]	1,9	81	AVG	08.99-06.00		4	0 432 193 744 <sup>1</sup>		
						4	0 432 193 746		
<b>2.5</b> TDI [8EC; B7]	2,5	120	BDG	11.04-05.06		6	0 432 133 783 <sup>1</sup>		
						6	0 432 133 785		
TDI [8E2; B6]	2,5	120	BCZ	06.03-12.04	EU3	6	0 432 133 792 <sup>1</sup>		
						6	0 432 133 794		
					EU4	6	0 432 133 783 <sup>1</sup>		
						6	0 432 133 785		
					BDG	06.03-12.04	EU3	6	0 432 133 792 <sup>1</sup>
								6	0 432 133 794
EU4	6	0 432 133 783 <sup>1</sup>							
TDI quattro [8E2; B6]	2,5	132	BAU	11.02-12.04	EU3	6	0 432 133 792 <sup>1</sup>		
						6	0 432 133 794		
					EU4	6	0 432 133 783 <sup>1</sup>		
						6	0 432 133 785		
					BDH	11.02-12.04	EU3	6	0 432 133 792 <sup>1</sup>
								6	0 432 133 794
EU4	6	0 432 133 783 <sup>1</sup>							
TDI, TDI quattro [8D2; B5]	2,5	110	AFB	08.97-06.00		6	0 432 133 833 <sup>1</sup>		
						6	0 432 133 835		
			AKN	07.98-10.00	AG	6	0 432 133 815 <sup>1</sup>		
						6	0 432 133 817		
					GS	6	0 432 133 822 <sup>1</sup>		
						6	0 432 133 824		
TDI, TDI quattro [8E2; B6]	2,5	114/120/ 132	AKE; AYM; BFC	12.00-05.03	EU3	6	0 432 133 792 <sup>1</sup>		
						6	0 432 133 794		
					EU4	6	0 432 133 783 <sup>1</sup>		
						6	0 432 133 785		
<b>A4 Avant</b>									
<b>1.9</b> TDI [8D5; B5]	1,9	66	AHH	04.97-09.01		4	0 432 193 702		
						4	0 432 193 704 <sup>1</sup>		
						4	0 432 193 837 <sup>1</sup>		
						4	0 432 193 838		
TDI, TDI quattro [8D5; B5]	1,9	81	AFN	02.96-07.99		4	0 432 193 837 <sup>1</sup>		
						4	0 432 193 838		
						4	0 432 193 744 <sup>1</sup>		
						4	0 432 193 746		
			AVG	08.99-06.00		4	0 432 193 744 <sup>1</sup>		
						4	0 432 193 746		
						4	0 432 193 746		
						4	0 432 193 746		
<b>2.5</b> TDI [8ED; B7]	2,5	120	BDG	11.04-05.06		6	0 432 133 783 <sup>1</sup>		
						6	0 432 133 785		
TDI [8E5; B6]	2,5	120	BCZ	06.03-12.04	EU3	6	0 432 133 792 <sup>1</sup>		
						6	0 432 133 794		
					EU4	6	0 432 133 783 <sup>1</sup>		
						6	0 432 133 785		
					BDG	06.03-12.04	EU3	6	0 432 133 792 <sup>1</sup>
								6	0 432 133 794
EU4	6	0 432 133 783 <sup>1</sup>							
TDI quattro [8E5; B6]	2,5	132	BAU	11.02-12.04	EU3	6	0 432 133 792 <sup>1</sup>		
						6	0 432 133 794		
					EU4	6	0 432 133 783 <sup>1</sup>		
						6	0 432 133 785		
					BDH	11.02-12.04	EU3	6	0 432 133 792 <sup>1</sup>
								6	0 432 133 794
EU4	6	0 432 133 783 <sup>1</sup>							
TDI, TDI quattro [8D5; B5]	2,5	110	AFB	11.97-06.00		6	0 432 133 833 <sup>1</sup>		
						6	0 432 133 835		





◀ AUDI

2.5 TDI, TDI quattro [8D5; B5]	2,5	110	AKN	07.98-09.01	AG	6	0 432 133 815 <sup>1</sup>
						6	0 432 133 817
						6	0 432 133 822 <sup>1</sup>
						6	0 432 133 824
TDI, TDI quattro [8E5; B6]	2,5	114/120/ 132	AKE; AYM; BFC	09.01-05.03	EU3	6	0 432 133 792 <sup>1</sup>
						6	0 432 133 794
					EU4	6	0 432 133 783 <sup>1</sup>
						6	0 432 133 785

**A4 Cabriolet**

2.5 TDI [8H7; B6]	2,5	120	BCZ	06.03-12.05	EU3	6	0 432 133 792 <sup>1</sup>
						6	0 432 133 794
					EU4	6	0 432 133 783 <sup>1</sup>
						6	0 432 133 785
			BDG	06.03-12.05	EU3	6	0 432 133 792 <sup>1</sup>
						6	0 432 133 794
					EU4	6	0 432 133 783 <sup>1</sup>
						6	0 432 133 785
			BFC	08.02-05.03	EU3	6	0 432 133 792 <sup>1</sup>
						6	0 432 133 794
					EU4	6	0 432 133 783 <sup>1</sup>
						6	0 432 133 785

**A6**

1.9 TDI [4A2; C4]	1,9	66	AHU; 1Z	06.94-10.97		4	0 432 193 837 <sup>1</sup>		
						4	0 432 193 838		
TDI [4B2; C5]	1,9	81	AFN; AVG	04.97-10.00		4	0 432 193 744 <sup>1</sup>		
						4	0 432 193 746		
2.5 TDI [4A2; C4]	2,5	85	AAT	06.94-10.97		5	0 432 193 785		
						5	0 432 193 787 <sup>1</sup>		
						EU3	6	0 432 133 792 <sup>1</sup>	
							6	0 432 133 794	
			120	BCZ	11.02-05.04	EU3	6	0 432 133 792 <sup>1</sup>	
							6	0 432 133 794	
					EU4	6	0 432 133 783 <sup>1</sup>		
						6	0 432 133 785		
			BDG	11.02-05.04	EU3	6	0 432 133 792 <sup>1</sup>		
						6	0 432 133 794		
					EU4	6	0 432 133 783 <sup>1</sup>		
						6	0 432 133 785		
BFC	07.02-05.03	EU3	6	0 432 133 792 <sup>1</sup>					
			6	0 432 133 794					
		EU4	6	0 432 133 783 <sup>1</sup>					
			6	0 432 133 785					
TDI, TDI quattro [4A2; C4]	2,5	103	AEL	10.94-10.97		5	0 432 193 786		
						5	0 432 193 788 <sup>1</sup>		
TDI, TDI quattro [4B2; C5]	2,5	110	AFB	04.97-05.00		6	0 432 133 833 <sup>1</sup>		
						6	0 432 133 835		
			AKN			11.98-04.01	AG	6	0 432 133 815 <sup>1</sup>
								6	0 432 133 817
		GS			6	0 432 133 822 <sup>1</sup>			
					6	0 432 133 824			
		132	AKE	10.99-05.01		6	0 432 133 802 <sup>1</sup>		
						6	0 432 133 804		
				06.01-08.03	EU3	6	0 432 133 792 <sup>1</sup>		
						6	0 432 133 794		
		EU4		6	0 432 133 783 <sup>1</sup>				
				6	0 432 133 785				
BAU	11.02-05.04	EU3	6	0 432 133 792 <sup>1</sup>					
			6	0 432 133 794					
		EU4	6	0 432 133 783 <sup>1</sup>					
			6	0 432 133 785					





2.5 TDI, TDI quattro [4B2; C5]	2,5	132	BDH	11.02-05.04	EU3	6	0 432 133 792 <sup>1</sup>
						6	0 432 133 794
						6	0 432 133 783 <sup>1</sup>
						6	0 432 133 785

**A6 Avant**

1.9 TDI [4A5; C4]	1,9	66	AHU; 1Z	07.94-10.97		4	0 432 193 837 <sup>1</sup>
						4	0 432 193 838

TDI [4B5; C5]	1,9	81	AFN	02.98-04.01		4	0 432 193 744 <sup>1</sup>
						4	0 432 193 746

2.5 TDI [4A5; C4]	2,5	85	AAT	06.94-10.97		5	0 432 193 785
						5	0 432 193 787 <sup>1</sup>

TDI [4B5; C5]	2,5	114	AYM	06.01-06.02	EU3	6	0 432 133 792 <sup>1</sup>
						6	0 432 133 794
						6	0 432 133 783 <sup>1</sup>

					EU4	6	0 432 133 785
						6	0 432 133 783 <sup>1</sup>
						6	0 432 133 785

120	BCZ	11.02-01.05	EU3	6	0 432 133 792 <sup>1</sup>
				6	0 432 133 794
				6	0 432 133 783 <sup>1</sup>

				6	0 432 133 785
				6	0 432 133 785
				6	0 432 133 785

BDG	11.02-01.05	EU3	6	0 432 133 792 <sup>1</sup>
			6	0 432 133 794
			6	0 432 133 783 <sup>1</sup>

				6	0 432 133 785
				6	0 432 133 785
				6	0 432 133 785

BFC	07.02-08.03	EU3	6	0 432 133 792 <sup>1</sup>
			6	0 432 133 794
			6	0 432 133 783 <sup>1</sup>

				6	0 432 133 785
				6	0 432 133 785
				6	0 432 133 785

TDI, TDI quattro [4A5; C4]	2,5	103	AEL	10.94-10.97		5	0 432 193 786
						5	0 432 193 788 <sup>1</sup>

TDI, TDI quattro [4B5; C5]	2,5	110	AFB	02.98-05.00		6	0 432 133 833 <sup>1</sup>
						6	0 432 133 835

AKN	11.98-04.01	AG	6	0 432 133 815 <sup>1</sup>
			6	0 432 133 817
			6	0 432 133 822 <sup>1</sup>

GS				6	0 432 133 824
				6	0 432 133 802 <sup>1</sup>
				6	0 432 133 824

132	AKE	10.99-05.01		6	0 432 133 802 <sup>1</sup>
				6	0 432 133 804
				6	0 432 133 792 <sup>1</sup>

				6	0 432 133 794
				6	0 432 133 783 <sup>1</sup>
				6	0 432 133 785

BAU	11.02-01.05	EU3	6	0 432 133 792 <sup>1</sup>
			6	0 432 133 794
			6	0 432 133 783 <sup>1</sup>

				6	0 432 133 785
				6	0 432 133 785
				6	0 432 133 785

BDH	11.02-01.05	EU3	6	0 432 133 792 <sup>1</sup>
			6	0 432 133 794
			6	0 432 133 783 <sup>1</sup>

				6	0 432 133 783 <sup>1</sup>
				6	0 432 133 785
				6	0 432 133 785

**A6 Avant Allroad**

2.5 TDI [4BH; C5]	2,5	120	BCZ	06.03-08.05		6	0 432 133 792 <sup>1</sup>
						6	0 432 133 794

132	AKE	05.00-05.03		6	0 432 133 802 <sup>1</sup>
				6	0 432 133 804
				6	0 432 133 792 <sup>1</sup>

BAU	06.03-08.05			6	0 432 133 792 <sup>1</sup>
				6	0 432 133 794
				6	0 432 133 794

**A8**

2.5 TDI, TDI quattro [4D2; D2]	2,5	110	AFB	06.97-06.00		6	0 432 133 833 <sup>1</sup>
						6	0 432 133 835

AKN	11.97-09.02	AG	6	0 432 133 815 <sup>1</sup>
			6	0 432 133 817
			6	0 432 133 822 <sup>1</sup>

GS				6	0 432 133 824
				6	0 432 133 824
				6	0 432 133 824





◀ AUDI

2.5 TDI, TDI quattro [4D2; D2]	2,5	132	AKE	11.99-09.02	6	0 432 133 802 <sup>1</sup>
					6	0 432 133 804

**Cabriolet**

1.9 TDI [8G7; B4]	1,9	66	AHU; 1Z	07.95-08.00	4	0 432 193 837 <sup>1</sup>
					4	0 432 193 838

**80**

1.6 D [81; 85; B2]	1,6	40	JK	08.82-03.87	4	0 432 217 084	0 986 430 081
D [89; 8A2; B3]	1,6	40	JK	09.86-07.89	4	0 432 217 164	

TD [81; 85; B2]	1,6	51	CY	08.81-03.87	4	0 432 217 079	0 986 430 080
-----------------	-----	----	----	-------------	---	---------------	---------------

1.9 D [89; 8A2; B3]	1,9	47	1Y	08.89-12.91	4	0 432 217 210	
---------------------	-----	----	----	-------------	---	---------------	--

TD [8C2; B4]	1,9	55	AAZ				
			Fg.Nr. 8C..N..400 001→	08.92-05.95	4	0 432 217 284	0 986 430 206

TDI [8C2; B4]	1,9	66	1Z				
			Fg.Nr. →8C..P..059 000	09.91-08.92	4	0 432 193 850	

			Fg.Nr. 8C..P..059 001→	08.92-05.95	4	0 432 193 837 <sup>1</sup>	
					4	0 432 193 838	

**80 Avant**

1.9 TD [8C5; B4]	1,9	55	AAZ	07.93-07.95	4	0 432 217 284	0 986 430 206
------------------	-----	----	-----	-------------	---	---------------	---------------

TDI [8C5; B4]	1,9	66	1Z				
			Fg.Nr. →8C..P..059 000	08.92-08.92	4	0 432 193 850	

			Fg.Nr. 8C..P..059 001→	08.92-07.95	4	0 432 193 837 <sup>1</sup>	
					4	0 432 193 838	

**100**

2.0 D [44; 44Q; C3]	2,0	51	CN	08.80-07.89	5	0 432 217 084	0 986 430 081
---------------------	-----	----	----	-------------	---	---------------	---------------

TD [44; 44Q; C3]	2,0	66	DE	08.82-12.87	5	0 432 217 079	0 986 430 080
------------------	-----	----	----	-------------	---	---------------	---------------

2.4 D [4A2; C4]	2,4	60	AAS	05.91-07.94	5	0 432 217 240	0 986 430 187
-----------------	-----	----	-----	-------------	---	---------------	---------------

D [44; 44Q; C3]	2,4	60	3D	08.89-12.90	5	0 432 217 210	
-----------------	-----	----	----	-------------	---	---------------	--

2.5 TDI [4A2; C4]	2,5	85	AAT	08.91-07.94	5	0 432 193 856 <sup>1</sup>	
-------------------	-----	----	-----	-------------	---	----------------------------	--

			ABP	06.91-07.92	5	0 432 193 877	
--	--	--	-----	-------------	---	---------------	--

TDI [44; 44Q; C3]	2,5	88	1T	01.90-12.90	5	0 432 193 877	
-------------------	-----	----	----	-------------	---	---------------	--

					5	0 432 193 880 <sup>1</sup>	
--	--	--	--	--	---	----------------------------	--

					5	0 432 193 880 <sup>1</sup>	
--	--	--	--	--	---	----------------------------	--

					5	0 432 193 880 <sup>1</sup>	
--	--	--	--	--	---	----------------------------	--

**100 Avant**

2.0 D [44; 44Q; C3]	2,0	51	CN	05.83-07.89	5	0 432 217 084	0 986 430 081
---------------------	-----	----	----	-------------	---	---------------	---------------

TD [44; 44Q; C3]	2,0	66	DE	05.83-12.87	5	0 432 217 079	0 986 430 080
------------------	-----	----	----	-------------	---	---------------	---------------

2.4 D [4A5; C4]	2,4	60	AAS	08.91-07.94	5	0 432 217 240	0 986 430 187
-----------------	-----	----	-----	-------------	---	---------------	---------------

D [44; 44Q; C3]	2,4	60	3D	08.89-12.90	5	0 432 217 210	
-----------------	-----	----	----	-------------	---	---------------	--

2.5 TDI [4A5; C4]	2,5	85	AAT	08.91-07.94	5	0 432 193 856 <sup>1</sup>	
-------------------	-----	----	-----	-------------	---	----------------------------	--

			ABP	08.91-07.92	5	0 432 193 877	
--	--	--	-----	-------------	---	---------------	--

TDI [44; 44Q; C3]	2,5	88	1T	01.90-12.90	5	0 432 193 877	
-------------------	-----	----	----	-------------	---	---------------	--

					5	0 432 193 880 <sup>1</sup>	
--	--	--	--	--	---	----------------------------	--

**BMW**

**Serie 3**

318 d [E 46]	2,0	85	20 4D 1 <M 47 D 20>	09.01-03.03	4	0 432 191 398	
--------------	-----	----	---------------------	-------------	---	---------------	--

					4	0 432 191 401 <sup>1</sup>	
--	--	--	--	--	---	----------------------------	--

tds [E 36]	1,7	66	17 4T 1 <M 41 D 18>	10.94-03.98	4	0 432 217 278	0 986 430 302
------------	-----	----	---------------------	-------------	---	---------------	---------------

					4	0 432 217 279 <sup>1</sup>	
--	--	--	--	--	---	----------------------------	--

320 d [E 46]	2,0	100	20 4D 1 <M 47 D 20>	04.98-09.01	4	0 432 191 527 <sup>1</sup>	
--------------	-----	-----	---------------------	-------------	---	----------------------------	--

					4	0 432 191 528	
--	--	--	--	--	---	---------------	--

324 d [E 30]	2,4	63	24 6D A/B <M 21 D 24>	09.85-03.87	6	0 432 217 184	
--------------	-----	----	-----------------------	-------------	---	---------------	--

				04.87-12.88	6	0 432 217 180	
--	--	--	--	-------------	---	---------------	--

				01.89-12.90	6	0 432 217 185 <sup>1</sup>	
--	--	--	--	-------------	---	----------------------------	--

					6	0 432 217 186	0 986 430 176
--	--	--	--	--	---	---------------	---------------

td [E 30]	2,4	85	24 6T B <M 21 D 24>	09.87-12.90	6	0 432 217 185 <sup>1</sup>	
-----------	-----	----	---------------------	-------------	---	----------------------------	--

					6	0 432 217 186	0 986 430 176
--	--	--	--	--	---	---------------	---------------



<b>325 td, tds [E 36]</b>	2,5	85/105	25 6T 1 <M 51 D 25>	09.91-01.96	6	<b>0 432 217 223</b>	<b>0 986 430 241</b>
				02.96-12.98	6	<b>0 432 217 236<sup>1</sup></b>	
					6	<b>0 432 217 278</b>	<b>0 986 430 302</b>
					6	<b>0 432 217 279<sup>1</sup></b>	
<b>Serie 3 Compact</b>							
<b>318 tds [E 36]</b>	1,7	66	17 4T 1 <M 41 D 18>	01.95-09.00	4	<b>0 432 217 278</b>	<b>0 986 430 302</b>
					4	<b>0 432 217 279<sup>1</sup></b>	
<b>Serie 3 Touring</b>							
<b>318 d [E 46]</b>	2,0	85	20 4D 1 <M 47 D 20>	03.02-03.03	4	<b>0 432 191 398</b>	
					4	<b>0 432 191 401<sup>1</sup></b>	
tds [E 36]	1,7	66	17 4T 1 <M 41 D 18>	03.95-12.99	4	<b>0 432 217 278</b>	<b>0 986 430 302</b>
					4	<b>0 432 217 279<sup>1</sup></b>	
<b>320 d [E 46]</b>	2,0	100	20 4D 1 <M 47 D 20>	10.99-09.01	4	<b>0 432 191 527<sup>1</sup></b>	
					4	<b>0 432 191 528</b>	
<b>324 td [E 30]</b>	2,4	85	24 6TB <M 21 D 24>	01.88-12.93	6	<b>0 432 217 185<sup>1</sup></b>	
					6	<b>0 432 217 186</b>	<b>0 986 430 176</b>
<b>325 tds [E 36]</b>	2,5	105	25 6T 1 <M 51 D 25>	09.95-01.96	6	<b>0 432 217 223</b>	<b>0 986 430 241</b>
				02.96-12.99	6	<b>0 432 217 236<sup>1</sup></b>	
					6	<b>0 432 217 278</b>	<b>0 986 430 302</b>
					6	<b>0 432 217 279<sup>1</sup></b>	
<b>Serie 5</b>							
<b>520 d [E 39]</b>	2,0	100	20 4D 1 <M 47 D 20>	04.00-07.03	4	<b>0 432 191 527<sup>1</sup></b>	
					4	<b>0 432 191 528</b>	
<b>524 d [E 28]</b>	2,4	63	24 6DA <M 21 D 24>	03.86-03.87	6	<b>0 432 217 184</b>	
				04.87-12.87	6	<b>0 432 217 180</b>	
td [E 28]	2,4	85	24 6TA <M 21 D 24>	09.83-01.87	6	<b>0 432 217 184</b>	
				01.87-12.87	6	<b>0 432 217 185<sup>1</sup></b>	
					6	<b>0 432 217 186</b>	<b>0 986 430 176</b>
td [E 34]	2,4	85	24 6TB <M 21 D 24>	03.88-12.91	6	<b>0 432 217 185<sup>1</sup></b>	
					6	<b>0 432 217 186</b>	<b>0 986 430 176</b>
<b>525 td, tds [E 34]</b>	2,5	85/105	25 6T 1 <M 51 D 25>	09.91-12.95	6	<b>0 432 217 223</b>	<b>0 986 430 241</b>
					6	<b>0 432 217 236<sup>1</sup></b>	
td, tds [E 39]	2,5	85/105	25 6T 1 <M 51 D 25>	01.96-09.00	6	<b>0 432 217 278</b>	<b>0 986 430 302</b>
					6	<b>0 432 217 279<sup>1</sup></b>	
<b>Serie 5 Touring</b>							
<b>520 d [E 39]</b>	2,0	100	20 4D 1 <M 47 D 20>	04.00-07.03	4	<b>0 432 191 527<sup>1</sup></b>	
					4	<b>0 432 191 528</b>	
<b>525 td, tds [E 34]</b>	2,5	85/105	25 6T 1 <M 51 D 25>	12.91-12.96	6	<b>0 432 217 223</b>	<b>0 986 430 241</b>
					6	<b>0 432 217 236<sup>1</sup></b>	
tds [E 39]	2,5	105	25 6T 1 <M 51 D 25>	03.97-09.00	6	<b>0 432 217 278</b>	<b>0 986 430 302</b>
					6	<b>0 432 217 279<sup>1</sup></b>	
<b>Serie 7</b>							
<b>725 tds [E 38]</b>	2,5	105	25 6T 1 <M 51 D 25>	01.96-12.00	6	<b>0 432 217 278</b>	<b>0 986 430 302</b>
					6	<b>0 432 217 279<sup>1</sup></b>	

**CHEVROLET**

<b>Blazer</b>							
<b>2.5 D</b>	2,5	74	4A	10.97-01.00	4	<b>0 432 193 766</b>	
<b>6.2</b>	6,2	97		09.88-08.90	8	<b>0 432 217 092</b>	
				09.90-08.91	U18	8	<b>0 432 217 092</b>
					U26	8	<b>0 432 217 275</b>
4x4	6,2	97		09.86-08.87	U18	8	<b>0 432 217 104</b>
					U26	8	<b>0 432 217 092</b>
				09.87-08.90		8	<b>0 432 217 092</b>
				09.90-08.91	U18	8	<b>0 432 217 092</b>
					U26	8	<b>0 432 217 275</b>
<b>6.5</b>	6,5	134		09.93-08.94		8	<b>0 432 217 276</b>
<b>C1500 Pickup</b>							
<b>6.5</b>	6,5	116		09.93-08.95		8	<b>0 432 217 275</b>
		142		09.93-08.98		8	<b>0 432 217 276</b>





◀ CHEVROLET

<b>C2500 Suburban</b>									
6.5	6,5	142			09.93-08.99		8	<b>0 432 217 276</b>	
<b>C3500 Pickup</b>									
6.2	6,2	110			09.87-08.88	U18	8	<b>0 432 217 104</b>	
						U26	8	<b>0 432 217 092</b>	
							8	<b>0 432 217 092</b>	
							8	<b>0 432 217 275</b>	
6.5	6,5	134-142	L65	09.91-08.02		8	<b>0 432 217 276</b>		
<b>Express 2500</b>									
6.5	6,5	142	L65		09.95-08.01		8	<b>0 432 217 276</b>	
<b>Express 3500</b>									
6.5	6,5	142	L65		09.96-08.03		8	<b>0 432 217 276</b>	
<b>K20 Suburban</b>									
6.2 4x4	6,2				09.82-08.86		8	<b>0 432 217 104</b>	
<b>K30</b>									
6.2 4x4	6,2				09.82-08.86		8	<b>0 432 217 104</b>	
<b>K1500 Pickup</b>									
6.2 4x4	6,2	97			09.87-08.88	U18	8	<b>0 432 217 104</b>	
						U26	8	<b>0 432 217 092</b>	
							8	<b>0 432 217 092</b>	
							8	<b>0 432 217 275</b>	
6.5 4x4	6,5	116			09.93-08.95		8	<b>0 432 217 275</b>	
		142			09.96-08.98		8	<b>0 432 217 276</b>	
<b>K2500 Pickup</b>									
6.2 4x4	6,2	97			09.87-08.88	U18	8	<b>0 432 217 104</b>	
						U26	8	<b>0 432 217 092</b>	
							8	<b>0 432 217 092</b>	
							8	<b>0 432 217 275</b>	
6.5 4x4	6,5				09.93-08.98		8	<b>0 432 217 276</b>	
		116			09.93-08.95		8	<b>0 432 217 275</b>	
		134-142	L65		09.91-08.97		8	<b>0 432 217 276</b>	
<b>K3500 Pickup</b>									
6.2 4x4	6,2	110			09.87-08.88	U18	8	<b>0 432 217 104</b>	
						U26	8	<b>0 432 217 092</b>	
							8	<b>0 432 217 092</b>	
							8	<b>0 432 217 275</b>	
6.5 4x4	6,5	134-142	L65		09.91-08.97		8	<b>0 432 217 276</b>	
<b>Tahoe</b>									
6.5 TD, TD 4x4	6,5	134	L56		09.94-08.99		8	<b>0 432 217 276</b>	
<b>V10 Suburban</b>									
6.2 4x4	6,2				09.86-08.87	U18	8	<b>0 432 217 104</b>	
						U26	8	<b>0 432 217 092</b>	
							8	<b>0 432 217 092</b>	
<b>V1500 Suburban</b>									
6.2 4x4	6,2				09.88-08.90		8	<b>0 432 217 092</b>	
					09.90-08.91	U26	8	<b>0 432 217 275</b>	



**CHRYSLER**

<b>Cherokee</b>										
2.5 D	2,5	83	VM		01.99-01.04		4	<b>0 432 217 281</b>		
							4	<b>0 432 217 282<sup>1</sup></b>		
							4	<b>0 432 217 294<sup>1</sup></b>		
3.1 D	3,1	110	EXA <VM 3,1 TDI>		01.00-12.01		5	<b>0 432 217 303<sup>1</sup></b>		
							5	<b>0 432 217 311</b>		
<b>Voyager</b>										
2.5 TD [ES]	2,5	85-87	VM HR 425 CLIEE <ENC>		04.92-12.95		4	<b>0 432 217 222</b>	<b>0 986 430 249</b>	
							4	<b>0 432 217 249<sup>1</sup></b>		
								4	<b>0 432 217 249<sup>1</sup></b>	
								4	<b>0 432 217 222</b>	<b>0 986 430 249</b>
TD [GS]	2,5	85	VM HR 425 CLIEE <ENC>		01.95-08.96		4	<b>0 432 217 249<sup>1</sup></b>		
					01.95-12.00		4	<b>0 432 217 222</b>	<b>0 986 430 249</b>	
					09.96-12.00		4	<b>0 432 217 304<sup>1</sup></b>		







◀ CITROEN

2.5 D Turbo [Y4]	2,5	94-96	THY <DK5ATE>	07.94-10.00		4	0 432 217 269	
						4	0 432 217 270 <sup>1</sup>	
<b>Xsara</b>								
1.9 D [N6]	1,9	50	DJY <XUD9A>	07.97-08.00	BO	4	0 432 217 248	0 986 430 244
D Turbo [N6]	1,9	55	DHV <XUD9BSD>	01.98-08.00		4	0 432 217 248	0 986 430 244
						4	0 432 217 301 <sup>1</sup>	
<b>Xsara Break</b>								
1.9 D [N6]	1,9	50	DJY <XUD9A>	04.98-08.00	BO	4	0 432 217 248	0 986 430 244
D Turbo [N6]	1,9	55	DHV <XUD9BSD>	04.98-08.00		4	0 432 217 248	0 986 430 244
						4	0 432 217 301 <sup>1</sup>	
<b>Xsara Coupé</b>								
1.9 D [N6]	1,9	50	DJY <XUD9A>	07.97-08.00	BO	4	0 432 217 248	0 986 430 244
D Turbo [N6]	1,9	55	DHV <XUD9BSD>	01.98-08.00		4	0 432 217 248	0 986 430 244
						4	0 432 217 301 <sup>1</sup>	
<b>ZX</b>								
1.9 D [N20/N21]	1,9	47-48	DJZ <XUD9Y>	03.91-04.94	BO	4	0 432 217 153	
		50	DJY <XUD9Y>					
			Org.Nr. 6371→	05.94-10.97	BO	4	0 432 217 248	0 986 430 244
		51-52	D9B <XUD9A>	03.91-10.97	BO	4	0 432 217 248	0 986 430 244
D Turbo [N20/N21]	1,9	66/68	DHY <XUD9TE/Y>; D8A <XUD9TE>	07.92-10.97	BO	4	0 432 217 218	0 986 430 240

**DAEWOO**

<b>Korando</b>								
2.3 D [KJ]	2,3	57	OM661 D23 <MB-OM 601.990>	07.96-12.00		4	0 432 217 157	0 986 430 197
2.9 D [KJ]	2,9	70-73	OM662 D29 <MB-OM 602.910>	07.96-12.00		5	0 432 217 157	0 986 430 197
TD Intercooler [KJ]	2,9	95	OM662 D29 <MB-OM 601.>	07.96-12.00		5	0 432 217 169	0 986 430 173
<b>Musso</b>								
2.3 D [MJ]	2,3	57	OM661 D23 <MB-OM 601.910>	07.93-12.00		4	0 432 217 157	0 986 430 197
2.9 D [MJ]	2,9	72	OM 662 D29 <OM 602.910>	07.93-12.00		5	0 432 217 157	0 986 430 197
TD Intercooler [MJ]	2,9	88	OM662 D29 <MB-OM 602>	05.97-12.00		5	0 432 217 169	0 986 430 173

**DODGE**

<b>Caravan</b>								
2.5 TD [NS]	2,5	85	VM HR 425 CLIEE <ENC>	01.95-08.96		4	0 432 217 249 <sup>1</sup>	
				01.95-08.03		4	0 432 217 222	0 986 430 249
				09.96-08.03		4	0 432 217 304 <sup>1</sup>	
<b>Ram 2500 Pickup</b>								
5.9	5,9	160-175	ETC	09.97-08.02	GS	6	0 432 193 630	
				09.99-08.02	AG	6	0 432 193 581	
		183	ETC	09.00-08.01	AG	6	0 432 193 581	
					GS	6	0 432 193 630	
, 4x4	5,9	131	ETB	09.97-08.98		6	0 432 193 630	
<b>Ram 3500 Pickup</b>								
5.9	5,9	183	ETC	09.00-08.02	AG	6	0 432 193 581	
					GS	6	0 432 193 630	
, 4x4	5,9	160-175	ETC	09.97-08.02	GS	6	0 432 193 630	
				09.99-08.02	AG	6	0 432 193 581	
4x4	5,9	131	ETB	09.97-08.98		6	0 432 193 630	

**FIAT**

<b>Brava</b>								
1.9 TD [182..]	1,9	55	182 A 8.000 <M9>; 182 A 8.000 <M20>	03.96-09.01		4	0 432 217 297	
<b>Bravo</b>								
1.9 TD [182..]	1,9	55	182 A 8.000 <M9>; 182 A 8.000 <M20>	03.96-09.01		4	0 432 217 297	
<b>Campagnola</b>								
2.5 D	2,5	53	8142.61..	06.79-10.86		4	0 432 297 034	0 986 430 144



Cityvan							
1.7 D [257..]	1,7	44	149 B 3.000 <M3> Mot.Nr. →617390	01.85-08.89	BO	4	0 432 217 148
Croma							
1.9 TD i.d. [154..]	1,9	66/69	154 B; 154 C 6.000 <M1> 69 154 D 1.000 <M2>	03.88-10.92 11.92-12.96		4	0 432 131 864 0 432 133 869
2.5 D [154..]	2,5	55	8144.67	12.85-12.89		4	0 432 297 034 0 986 430 144
TD [154..]	2,5	74	8144.91.2200	12.85-02.89		4	0 432 297 048
		77/85/86	8144.97 <M3>; 8144.97 S <M4>; 8144.97.2200	03.89-11.92		4	0 432 297 048
		85	8144.97Y (EM.04) <M5>	11.92-12.96		4	0 432 217 247
TDI [154..]	2,5	85	8144.97Y (US87) <M5>	09.93-11.96		4	0 432 217 260 <sup>1</sup> 0 432 217 261
Duna							
1.7 D [155..]	1,7	44	149 B 3.000 Mot.Nr. →617390	10.86-12.90	BO	4	0 432 217 148
Duna Weekend							
1.7 D [155..]	1,7	44	149 B 3.000 Mot.Nr. →617390	10.86-12.90	BO	4	0 432 217 148
Fiorino							
1.3 D [127..]	1,3	33	127 A 5.000	01.84-12.87	BO	4	0 432 217 129
D [255..]	1,3	33	127 A 5.000 <M4>	01.88-08.93		4	0 432 217 202
1.7 D [255..]	1,7	42/43	146 B 2.000 <M6>; 149 B 3.000 <M5>; 149 B 4.046 <M7> Mot.Nr. →617390	01.88-08.93	BO	4	0 432 217 148
Fiorino Furgao							
1.7 D	1,7	52	146 B 2.000	01.04-12.08		4	0 432 217 195
Marea							
1.9 TD [185..]	1,9	55,1	182 A 8.000 <M2>	10.96-09.02		4	0 432 217 297
2.4 TD [185..]	2,4	91	185 A 2.000 <M3> Mot.Nr. →0918278	10.96-02.99		5	0 432 217 273
			Mot.Nr. →0918279	10.96-02.99		5	0 432 217 274 <sup>1</sup>
			Mot.Nr. 0918279→	10.96-02.99		5	0 432 217 297
			Mot.Nr. 0918280→	10.96-02.99		5	0 432 217 296 <sup>1</sup>
Marengo							
1.9 D [259..]	1,9	48	160 A 7.000 <M1> Mot.Nr. →1360563	02.90-12.96		4	0 432 217 195
D Turbo [259..]	1,9	66	160 A 6.000 <M2>	02.90-12.96	BO	4	0 432 217 211
TD [285..]	1,9	55/55,1	182 A 8.000 <M2>	01.97-09.02		4	0 432 217 297
2000 D [138..]	2,0	48	149 A 1..	01.86-07.89	BO	4	0 432 217 129
Palio							
1.7 D	1,7	52	M 708 N7 17 L	09.97-08.01		4	0 432 217 211
D Turbo [Fase II]	1,7	52		01.04-12.07		4	0 432 217 211
Palio SW							
1.7 T	1,7	53	M 708 H7 17D	09.97-08.01		4	0 432 217 211
Palio Weekend							
1.7 D Turbo [Fase II]	1,7	52		10.04-12.08		4	0 432 217 211
TD [178..]	1,7	51	176 A 3.000 <M3>	09.97-10.00		4	0 432 217 211
Panda							
1.3 D [141..]	1,3	27	156 A 5.000	07.90-08.92		4	0 432 217 172
1300 D [141..]	1,3	27	156 A 5.000	03.86-12.89	BO	4	0 432 217 129
Punto							
1.7 TD [176]	1,7	46/51-53	176 A 3.000 <M2>; 176 A 5.000 <M1>; 176 B 7.000 <M3>; 176 B 7.000 <M4>	08.93-08.99		4	0 432 217 211
Punto VAN							
1.7 TD, TD SOFT [276]	1,7	46/51/53	176 A 3.000 <M2>; 176 A 5.000 <M1>; 176 B 7.000 <M3>	05.97-08.99		4	0 432 217 211
Regata							
1.7 D [138..]	1,7	44	149 B 3.000	05.85-03.89	BO	4	0 432 217 148
1.9 D Super [138..]	1,9	48	149 A 1..	04.84-07.89	BO	4	0 432 217 129
D Turbo [138..]	1,9	59	831 D 1..	05.86-07.89	BO	4	0 432 217 139





◀ FIAT

Ritmo							
1.7 D [138A..]	1,7	44	149 B 3..	05.85-12.87	BO	4	0 432 217 148
1.9 D Turbo [138A..]	1,9	59	831 D 1..	12.85-12.87	BO	4	0 432 217 139
Scudo							
1.9 D [222..]	1,9	51	D9B <M2>	10.95-05.00		4	0 432 217 248 0 986 430 244
TD [222..]	1,9	66	DHX <M4>	03.97-05.00		4	0 432 217 286 <sup>1</sup>
		68	D8B <M3>	10.95-05.00		4	0 432 217 289 0 986 430 375
						4	0 432 217 218 0 986 430 240
Strada							
1.7 D Turbo	1,7	52		07.99-12.04		4	0 432 217 211
D Turbo [Fase II]	1,7	52		01.05-12.08		4	0 432 217 211
TDS [278]	1,7	51	176 A 3.000 <M10>	03.99-03.03		4	0 432 217 211
Tempra							
1.9 D [159]	1,9	48	160 A 7.000 <M1>				
			Mot.Nr. →1360563	02.90-03.93		4	0 432 217 195
				04.93-12.96	BO	4	0 432 217 195
TD [159]	1,9	60/66/68	160 A 6.000 <M2>; 160 A 6.046 <M4>; 160 B 6.046 <M3>; 160 D 1.000 <M3>	02.90-12.96	BO	4	0 432 217 211
Tempra SW							
1.9 D [159]	1,9	48	160 A 7.000 <M1>				
			Mot.Nr. →1360563	12.90-03.93		4	0 432 217 195
				04.93-12.96	BO	4	0 432 217 195
TD [159]	1,9	60/66/68	160 A 6.000 <M2>; 160 A 6.046 <M4>; 160 B 6.046 <M3>; 160 D 1.000 <M3>	02.90-12.96	BO	4	0 432 217 211
Tipo							
1.7 D [160..]	1,7	42	149 B 4.000 <M1>				
			Mot.Nr. →538535	07.87-03.93	BO	4	0 432 217 148
			Mot.Nr. 538536→	07.87-03.93	BO	4	0 432 217 195
1.9 D [160..]	1,9	48	160 A 7.000 <M2>	03.93-10.95		4	0 432 217 195
			Mot.Nr. →538535	07.89-03.93	BO	4	0 432 217 148
			Mot.Nr. 538536→	07.89-03.93	BO	4	0 432 217 195
D Turbo [160..]	1,9	65	160 D 1.000 <M4>	03.93-10.95		4	0 432 217 211
		68	160 A 6.000 <M3>	03.93-10.95		4	0 432 217 211
TD [160..]	1,9	59	160 B 6.046 <M4>				
			Mot.Nr. →0773741	06.90-03.93	BO	4	0 432 217 172
			Mot.Nr. 0773742→	06.90-03.93	BO	4	0 432 217 195
		67,6	160 A 6.046 <M5>				
			Mot.Nr. →0773741	06.90-03.93	BO	4	0 432 217 172
			Mot.Nr. 0773742→	06.90-03.93	BO	4	0 432 217 195
		68	160 A 6.000 <M3>				
			Mot.Nr. →0773741	07.87-03.93	BO	4	0 432 217 172
			Mot.Nr. 0773742→	07.87-03.93	BO	4	0 432 217 195
Ulysse							
1.9 TD [121..]	1,9	66	DHX <M4>; D8B <M3>	01.95-05.98		4	0 432 217 218 0 986 430 240
			DHX <M7>	10.96-12.99		4	0 432 217 286 <sup>1</sup>
						4	0 432 217 289 0 986 430 375
Uno							
1.3 D	1,3	33	146B000	05.91-12.94		4	0 432 217 202
D [146..]	1,3	33	127 A 5.000	01.84-08.89	BO	4	0 432 217 129
			146 B 1.000 <M1>	09.89-03.92	BO	4	0 432 217 202
1.4 D Turbo [146..]	1,4	52	146 B 3.000 <M2>	09.89-09.92	BO	4	0 432 217 211
TD [146..]	1,4	52	146 B 3.000	03.86-08.89		4	0 432 217 172
1.7 D [146..]	1,7	42	146 B 2.000 <M3>	09.89-03.94	BO	4	0 432 217 195
		44	149 B 3.000	07.86-08.89	BO	4	0 432 217 148
1.9 D [146..]	1,9	44	149 B 5.046 <M4>	09.89-03.94	BO	4	0 432 217 129
Uno Van							
1.7 D [246..]	1,7	42	146 B 2.000 <M3>	01.91-03.94	BO	4	0 432 217 195
127							
1300 D, D Panorama	1,3	33	127 A..	01.84-12.86	BO	4	0 432 217 129
147							
1.3 CLD Spazio	1,3	33	146B000	02.84-11.97		4	9 430 082 271





**FISSORE**

<b>Magnum</b>						
2.4 D Turbo 4x4	2,4	77	Sofim 8144.81..	07.84-04.86	4	<b>0 432 297 048</b>
<b>Rayton</b>						
2.4 D Turbo 4x4	2,4	82	HR 492 HIM	03.88-12.01	4	<b>0 432 297 047</b>

**FORCE MOTORS (BAJAJ TEMPO)**

<b>Trax</b>						
2.4 D	2,4	44	OM616 <D98>	01.92-07.05	4	<b>9 430 032 327</b>

**FORD**

<b>Courier</b>						
1.8 D	1,8	44	DKK <Endura-DE>	05.99→	4	<b>0 432 217 267</b>
<b>Escort</b>						
1.8 D	1,8	44	RTF; RTH <Endura-DE>	01.95-11.01 BO	4	<b>0 432 217 267</b>
<b>Escort IV</b>						
1.6 D [86]	1,6	40	LTC <D16>	01.86-12.88 BO	4	<b>0 432 217 146</b>
1.8 D [86]	1,8	44	RTA <IDI>; RTB <IDI>	01.89-07.90	4	<b>0 432 217 188 0 986 430 208</b>
<b>Escort IV Express</b>						
1.6 D [86]	1,6	40	LTC <D16>	01.86-12.88 BO	4	<b>0 432 217 146</b>
1.8 D [86]	1,8	44	RT... <D18>	01.89-07.90	4	<b>0 432 217 188 0 986 430 208</b>
<b>Escort IV Turnier</b>						
1.6 D [86]	1,6	40	LTC <D16>	01.86-12.88 BO	4	<b>0 432 217 146</b>
1.8 D [86]	1,8	44	RT... <IDI>	01.89-07.90	4	<b>0 432 217 188 0 986 430 208</b>
<b>Escort VII</b>						
1.8 D [95]	1,8	44	RT... <D18NA>; RTF <D18NA>; RTH <D18NA>	01.95-09.01 BO	4	<b>0 432 217 267</b>
<b>Escort VII Express</b>						
1.8 D 55, D 75 [95]	1,8	44	RTF <D18NA>; RTH <D18NA>	01.95-09.01 BO	4	<b>0 432 217 267</b>
<b>Escort VII Turnier</b>						
1.8 D [95]	1,8	44	RTF <D18NA>; RTH <D18NA>	01.95-09.01 BO	4	<b>0 432 217 267</b>
<b>Escort V/VI</b>						
1.8 D [91]	1,8	44	RT... <D18NA>	08.90-12.94 BO,N07 10.93-12.94 BO,E93	4 4	<b>0 432 217 188 0 986 430 208</b> <b>0 432 217 267</b>
<b>Escort V/VI Express</b>						
1.8 D [91]	1,8	44	RTH <D18NA>	08.90-12.94 BO,N07 10.93-12.94 BO,E93	4 4	<b>0 432 217 188 0 986 430 208</b> <b>0 432 217 267</b>
<b>Escort V/VI Turnier</b>						
1.8 D [91]	1,8	44	RTH <D18NA>	08.90-12.94 BO,N07 10.93-12.94 BO,E93	4 4	<b>0 432 217 188 0 986 430 208</b> <b>0 432 217 267</b>
<b>Fiesta</b>						
1.8 D	1,8	44	RTC; RTD <Endura-DE>	05.99-08.03	4	<b>0 432 217 267</b>
<b>Fiesta II</b>						
1.6 D [84]	1,6	40	LTB <XLD>	04.85-02.89 BO	4	<b>0 432 217 146</b>
<b>Fiesta III</b>						
1.8 D [89]	1,8	44	RT... <DSL>	03.89-12.96 BO,E93 BO,N07	4 4	<b>0 432 217 267</b> <b>0 432 217 188 0 986 430 208</b>
<b>Fiesta III Courier</b>						
1.8 D [89]	1,8	44	RT... <D18NA>	09.91-08.96 BO,E93 BO,N07	4 4	<b>0 432 217 267</b> <b>0 432 217 188 0 986 430 208</b>
<b>Fiesta IV</b>						
1.8 D [96]	1,8	44	RT... <D18, Endura-DE>	10.95-06.01 BO,E93 BO,E96 BO,N07	4 4 4	<b>0 432 217 267</b> <b>0 432 217 293 0 986 430 520</b> <b>0 432 217 188 0 986 430 208</b>
<b>Fiesta IV Courier</b>						
1.8 D [96]	1,8	44	RT... <D18, Endura-DE>	10.95-06.01 BO,E93 BO,N07	4 4	<b>0 432 217 267</b> <b>0 432 217 188 0 986 430 208</b>





◀ FORD

Galaxy							
1.9 TDI [95]	1,9	66	AHU <D19N (VW 19N)>; 1Z <D19N (VW 19N)>	02.95-03.00	4	0 432 193 829 †	
					4	0 432 193 838	
		81	AFN <D19P (VW 19P)>; AVG <D19P (VW 19P)>	11.97-03.00	4	0 432 193 744 †	
					4	0 432 193 746	
Granada III							
2.5 D Turbo [92]	2,5	68	SF... <PD25T>	02.92-09.94	4	0 432 217 222	0 986 430 249
					4	0 432 217 249 †	
Granada III Estate							
2.5 D Turbo [92]	2,5	68	SF... <PD25T>	02.92-09.94	4	0 432 217 222	0 986 430 249
					4	0 432 217 249 †	
Maverick							
2.7 TD [UDS, UNS]	2,7	74	TD27	06.93-04.96	4	9 430 610 125	
Mondeo III							
2.0 TDDi [01]	2,0	66	D5BA <Duratorq-DI>	10.00-03.07	4	0 432 133 800	
		85	D6BA <Duratorq-DI>	10.00-08.02	4	0 432 133 801	
Mondeo III Turnier							
2.0 TDDi [01]	2,0	66	D5BA <Duratorq-DI>	10.00-03.07	4	0 432 133 800	
		85	D6BA <Duratorq-DI>	10.00-08.02	4	0 432 133 801	
Orion II							
1.6 D [86]	1,6	40	LTC <D16>	04.86-01.89	BO	4	0 432 217 146
1.8 D [86]	1,8	44	RT... <DI>	01.89-07.90		4	0 432 217 188 0 986 430 208
Orion III							
1.8 D [91]	1,8	44	RT... <DI>	07.90-12.93	BO,N07	4	0 432 217 188 0 986 430 208
				10.93-12.93	BO,E93	4	0 432 217 267
Ranger							
2.5 TD [99]	2,5	80	WL-T <MD25TI(HP)>	01.99-10.07		4	9 430 610 157
Scorpio I							
2.5 TD [92]	2,5	68/85	SCB <VM25T>; SF... <PD25T>	03.92-09.94		4	0 432 217 222 0 986 430 249
						4	0 432 217 249 †
Scorpio I Turnier							
2.5 TD [92]	2,5	68/85	SCB <VM25T>; SF... <PD25T>	03.92-09.94		4	0 432 217 222 0 986 430 249
						4	0 432 217 249 †
Scorpio II							
2.5 TD [95]	2,5	85	SCC <VM25-TCI>	10.94-12.98		4	0 432 217 222 0 986 430 249
						4	0 432 217 249 †
		92	SCD <VM25-TCI>	10.94-12.98		4	0 432 217 222 0 986 430 249
						4	0 432 217 249 †
Scorpio II Turnier							
2.5 TD [95]	2,5	85/92	SCC <VM25-TCI>; SCD <VM25-TCI>	10.94-12.98		4	0 432 217 222 0 986 430 249
						4	0 432 217 249 †

**FSO**

Polonez Caro							
1.9 D	1,9	51	XUD 9A	01.93-12.02	4	0 432 217 201	

**GMC (GENERAL MOTORS CORP.)**

Jimmy							
6.2 4x4	6,2			09.82-08.87	8	0 432 217 104	
				09.86-08.91	8	0 432 217 092	
				09.90-08.91	8	0 432 217 275	
Savana 2500							
6.5	6,5	145-160	L65	01.96-08.02	8	0 432 217 276	
Serie C							
1500 6.2	6,2	108	LH6	09.82-08.88	8	0 432 217 104	
				09.87-08.90	8	0 432 217 092	
				09.90-08.93	8	0 432 217 275	
Serie C Suburban							
2500 6.5	6,5		L65	09.93-08.99	8	0 432 217 276	



Serie K							
1500 6.2 4x4	6,2	97			09.84-08.86	8	0 432 217 104
		108	LH6		09.82-08.88	8	0 432 217 104
					09.87-08.90	8	0 432 217 092
					09.90-08.93	8	0 432 217 275
6.5 4x4	6,5	134	L49		09.93-08.94	8	0 432 217 275
3500 6.5 4x4	6,5		L65		09.91-08.00	8	0 432 217 276
Yukon							
6.5 4x4	6,5	134-145	L65		09.93-08.97	8	0 432 217 276

HONDA

Accord Hatchback							
2.0 TDi [CG/CH/CL]	2,0	77	20T2N		01.99-10.00	4	0 432 193 819
						4	0 432 193 820 <sup>1</sup>
Accord Sedan							
2.0 D Turbo [CE/CF]	2,0	77	20T2N		09.95-10.98	4	0 432 193 819
						4	0 432 193 820 <sup>1</sup>
TDi [CG/CH/CL]	2,0	77	20T2N		01.99-02.03	4	0 432 193 819
						4	0 432 193 820 <sup>1</sup>
Civic Aerodeck							
2.0 D Turbo [MB/MC]	2,0	77	20T2N		04.98-02.01	4	0 432 193 819
						4	0 432 193 820 <sup>1</sup>
Civic Fastback							
2.0 D [MB/MC]	2,0	63	20T2N		03.97-02.01	4	0 432 193 819
						4	0 432 193 820 <sup>1</sup>

INNOCENTI (NUOVA INNOCENTI)

Elba							
1.7 D	1,7	42	146 B 2.000		09.92-12.96	4	0 432 217 195
			146 B 2.000 <M5>		09.92-12.96	4	0 432 217 195

ISUZU

Gemini							
1.5 D	1,5	37	4EC1		02.88-12.93	4	9 430 610 073
		40	4EC1		01.88-12.93	4	9 430 610 066
		D Turbo	49	4EC1T		02.88-12.93	4
Pick-Up							
2.0 D [KB]	2,0	34	C190		01.83-12.93	4	9 430 610 010
2.2 D [KB]	2,2	39	C223		04.86-12.90	4	9 430 610 031
			Fg.Nr. C*6206726→		08.86-12.90	4	9 430 610 461
Trooper							
2.2 D [UBS]	2,2	53	C223		10.83-10.88	4	9 430 610 010
D Turbo [UBS]	2,2	84	C223T		03.84-10.88	4	9 430 610 032
2.8 D Turbo [UBS]	2,8	71	4JB1T		10.87-12.91	4	9 430 610 062
D Turbo Interc. [UBS]	2,8	78	4JB1TC		10.88-12.91	4	9 430 610 069

JEEP

Cherokee							
2.1 D Turbo [XJ]	2,1	64/65	Renault J8S-814		04.84-08.95	4	0 432 297 045
		65	Renault J8S-890		09.90-08.95	4	0 432 297 050
2.5 D Turbo [XJ]	2,5	85-89	ENC,ENO <VM HR 425 CLIRX>		10.95-12.01	4	0 432 217 222 0 986 430 249
						4	0 432 217 249 <sup>1</sup>
Wagoneer							
2.1 D Turbo [SJ]	2,1	64	J8S-814		01.88-12.94	4	0 432 297 045





**KIA**

Carnival						
2.9 D Turbo [UP]	2,9	93	J3		06.98-09.01	4 <b>0 432 193 655</b>
Sedona						
2.9 D Turbo [UP]	2,9	93	J3		06.98-09.01	4 <b>0 432 193 655</b>

**LADA**

Niva						
1.5 TD	1,5	48	3411		09.94-12.99	4 <b>0 432 217 194</b>
1.8 TD	1,8	55	3431		07.99-12.00	4 <b>0 432 217 194</b>
Serie 2100						
2104 1.5 TD	1,5	48	341		01.97-12.00	4 <b>0 432 217 194</b>

**LANCIA**

Dedra Berlina						
1.9 TD [835]	1,9	66	835A4.000 <M1>; 835A4.000/ 160D1.000 <M1/M2>		01.89-10.99	4 <b>0 432 217 211</b>

Dedra Station Wagon						
1.9 TD [835]	1,9	66	835A4.000/160D1.000 <M1/M2>		10.94-10.99	4 <b>0 432 217 211</b>

Delta						
1.9 TD [831]	1,9	59	831D1.000 <M8>		06.86-05.88	4 <b>0 432 217 139</b>
					06.88-06.91	4 <b>0 432 217 172</b>

Kappa Berlina						
2.4 TD [838]	2,4	91	838A3.000 <M1>	Ricam.Nr →2065499	11.94-06.96	5 <b>0 432 217 273</b>
						5 <b>0 432 217 274<sup>1</sup></b>
				Ricam.Nr 2065500→	11.94-06.96	5 <b>0 432 217 296<sup>1</sup></b>
						5 <b>0 432 217 297</b>
				838A7.000 <M2>		
				Ricam.Nr →2065499	06.96-03.98	5 <b>0 432 217 273</b>
		5 <b>0 432 217 274<sup>1</sup></b>				
		Ricam.Nr 2065500→	06.96-03.98	5 <b>0 432 217 296<sup>1</sup></b>		
				5 <b>0 432 217 297</b>		

Kappa Station Wagon						
2.4 D Turbo [838]	2,4	91	838A7.000 <M2>	Ricam.Nr →2065499	06.96-03.98	5 <b>0 432 217 273</b>
						5 <b>0 432 217 274<sup>1</sup></b>
				Ricam.Nr 2065500→	06.96-03.98	5 <b>0 432 217 296<sup>1</sup></b>
						5 <b>0 432 217 297</b>

Prisma						
1.9 D	1,9	48	831 D..		06.84-05.88 BO	4 <b>0 432 217 129</b>
					06.88-12.89	4 <b>0 432 217 182</b>
				D Turbo	05.85-05.88 BO	4 <b>0 432 217 139</b>
					06.88-12.89	4 <b>0 432 217 172</b>

Thema Berlina						
2.5 TD [104]	2,5	74	8144.91.2200		11.84-09.88	4 <b>0 432 297 048</b>
		85	8144.97Y		01.93-11.94	4 <b>0 432 217 260<sup>1</sup></b>
						4 <b>0 432 217 261</b>

Thema Station Wagon						
2.5 TD [104]	2,5	74	8144.91.2200		11.84-09.88	4 <b>0 432 297 048</b>
		85	8144.97Y		05.92-11.94	4 <b>0 432 217 247</b>
			8144.97Y EDC-Bosch		01.93-11.94	4 <b>0 432 217 260<sup>1</sup></b>
						4 <b>0 432 217 261</b>







**LAND ROVER GROUP**

<b>Defender 90</b>							
2.5 D Turbo	2,5	80-83	Gemini TCI D.I. 23L <200/300 Tdi>				
			Mot.Nr. 11 L...→	08.90-12.01	4	<b>0 432 193 879</b>	
			Mot.Nr. 16 L...→	09.94-12.01	4	<b>0 432 193 835</b>	
<b>Defender 110</b>							
2.5 D Turbo	2,5	80-83	Gemini TCI D.I. 23L <200/300 Tdi>				
			Mot.Nr. 11 L...→	08.90-12.01	4	<b>0 432 193 879</b>	
			Mot.Nr. 16 L...→	09.94-12.01	4	<b>0 432 193 835</b>	
		85	Maxion HS4TCC <Euro I>	08.98-12.05	4	<b>0 432 193 835</b>	
				02.00-12.05	4	<b>0 432 193 583</b>	
<b>Defender 130</b>							
2.5 D Turbo	2,5	80-83	Gemini TCI D.I. 23L <200/300 Tdi>				
			Mot.Nr. 11 L...→	08.90-12.01	4	<b>0 432 193 879</b>	
			Mot.Nr. 16 L...→	09.94-12.01	4	<b>0 432 193 835</b>	
		85	Maxion HS4TCC <Euro II>	02.00-12.05	4	<b>0 432 193 583</b>	
<b>Discovery I</b>							
2.5 Tdi	2,5	82-83	200 Tdi	09.89-09.94	4	<b>0 432 193 879</b>	
		82-90	19L 21L 22L 300 Gemi	10.93-12.98	4	<b>0 432 193 834<sup>1</sup></b>	
				AGR	4	<b>0 432 193 835</b>	
<b>Freelander</b>							
2.0 D [LN]	2,0	70-72	20T <L-Serie>	09.97-09.03	BO	4	<b>0 432 193 700<sup>1</sup></b>
						4	<b>0 432 193 701</b>
<b>Land Rover 110</b>							
2.5 D Turbo	2,5	79	200 Tdi, 300 Tdi <DI TCI Gemini>	07.89-07.90		4	<b>0 432 193 879</b>
<b>Range Rover I</b>							
2.4 D Turbo	2,4	78-89	VM-81A	04.86-12.90		4	<b>0 432 297 047</b>
2.5 D Turbo	2,5	89	VM-HR-492.4	09.90-09.94		4	<b>0 432 297 047</b>
Tdi Classic	2,5	83	14L <200 TDi>	10.92-09.95		4	<b>0 432 193 879</b>
<b>Range Rover II</b>							
2.5 D	2,5	100-102	25 6T	09.94-08.02		6	<b>0 432 217 223 0 986 430 241</b>
						6	<b>0 432 217 236<sup>1</sup></b>
Tdi	2,5	81-83	14L <300 TDi>	10.94-04.96	AGF	4	<b>0 432 193 834<sup>1</sup></b>
					AGR	4	<b>0 432 193 835</b>
					EDC	4	<b>0 432 193 836</b>

**MAHINDRA**

<b>Bolero</b>							
2.5 D	2,5	53	XD 3P IDI	05.00-04.05	BS1	4	<b>F 002 C6Z 397</b>
D, D XLS	2,5	46	MDI 3200TC	05.05→	TW	4	<b>F 002 C8Z 885</b>
						4	<b>F 002 C8Z 890</b>
D XL	2,5	43	MDI 3200D	01.04-03.05	BS1	4	<b>F 002 C8Z 867</b>
					BS2	4	<b>F 002 C8Z 881</b>
D XLS	2,5	44,5	XD 3PH	01.04-12.05	BS1	4	<b>F 002 C6Z 397</b>
D 4WD	2,5	46	MDI 3200 TC	05.05→	TW	4	<b>F 002 C8Z 885</b>
						4	<b>F 002 C8Z 890</b>
		53	XD 3P IDI	05.00-04.05		4	<b>F 002 C6Z 397</b>
<b>Bolero Invader</b>							
2.5 D	2,5	40	MDI 3200	06.03-10.04		4	<b>F 002 C8Z 867</b>
D, D 4WD	2,5	46	MDI 3200 TC	12.04→	TW	4	<b>F 002 C8Z 885</b>
						4	<b>F 002 C8Z 890</b>
D GLX	2,5	53	XD 3P IDI	06.03-10.04		4	<b>F 002 C6Z 397</b>
<b>Classic</b>							
2.1 D 4WD	2,1	46	XDP 4.90	05.96-10.97		4	<b>9 430 032 285</b>
				11.97-10.02		4	<b>F 002 C6Z 201</b>
<b>MM 540/550</b>							
DP 2.1 D 4WD	2,1	46	XDP 4.90C	04.91-10.97		4	<b>9 430 032 285</b>
				11.97→		4	<b>F 002 C6Z 201</b>
XDB 2.5 D, D 4WD	2,5	53	XD 3P	11.91-05.97		4	<b>9 430 032 273</b>





◀ MAHINDRA

MM 775 XDB							
2.5 D	2,5	53	XD 3PB	05.91→		4	9 430 032 273
Scorpio							
2.6 D Turbo	2,6	80	SZ2600 plus	06.02-03.06	BS1	4	F 002 C7Z 213
					BS2	4	F 002 C7Z 209
D Turbo 4WD [MI]	2,6	80	SZ2600 plus	06.02-03.06	BS1	4	F 002 C7Z 213
					BS2	4	F 002 C7Z 209

**MAZDA**

MPV							
2.5 12V D Turbo [LV]	2,5	85	WLT	03.96-05.99		4	9 430 610 157
Serie B							
2500 D [UN]	2,5	57	MD25NA	02.99-07.02	EU3	4	9 430 610 441
				02.99-03.06	KZE,RSA	4	9 430 610 159
					WEI	4	9 430 610 158
D Turbo, D Turbo 4x4 [UN]	2,5	62	WLE7	09.01-07.02	EU3	4	9 430 610 157
				09.01-03.06	KZE,RSA	4	9 430 610 159
					WEI	4	9 430 610 158
D Turbo 4x4 [UN]	2,5	80	WLT	02.99-07.02	EU3	4	9 430 610 441
				02.99-03.06	KZE,RSA	4	9 430 610 159
					WEI	4	9 430 610 158
D 4x4 [UN]	2,5	57		02.99-07.02	EU3	4	9 430 610 441
				02.99-03.06	KZE,RSA	4	9 430 610 159
					WEI	4	9 430 610 158
12V D [UF]	2,5	63	WL	03.96-05.99		4	9 430 610 157
12V D 4x4 [UF]	2,5	57-63	WL	03.96-05.99		4	9 430 610 157
323							
1.7 D [BF]	1,7	40-44	PN27	04.85-04.87		4	9 430 610 043
				05.87-05.89		4	9 430 610 049
2.0 D [BJ]	2,0	52	RF	05.98-10.00		4	9 430 610 440
323 Hatchback							
P 2.0 D [BA]	2,0	52	RF	03.97-09.00		4	9 430 610 439
1.7 D [BG]	1,7	41/43	PN46; PN62	06.89-02.96		4	9 430 610 088
2.0 D [BJ]	2,0	52	RF	06.98-09.99		4	9 430 610 440
323 Sedan							
1.7 D [BG]	1,7	41/43	PN46; PN62	06.89-05.94		4	9 430 610 088
2.0 D [BA]	2,0	52	RF	03.97-06.98		4	9 430 610 439
323 Wagon							
1.7 D [BW]	1,7	40-44	PN27	04.86-06.87		4	9 430 610 043
		41	PN26	07.87-08.89		4	9 430 610 049
				09.89-04.90		4	9 430 610 088
			PN54	09.89-06.95		4	9 430 610 088
626							
2.0 D [GC]	2,0	53	RF46	07.85-06.87		4	9 430 610 055
D [GD]	2,0	44	RF	07.87-08.89		4	9 430 610 007
				09.89-07.91		4	9 430 610 007
D Complex [GE]	2,0	55	RF	03.92-03.97		4	9 430 610 109
626 Hatchback							
2.0 D Complex [GE]	2,0	55	RF	03.92-12.95		4	9 430 610 109
				12.95-03.97		4	9 430 610 292
626 Wagon							
2.0 D [GV]	2,0	44	RF	03.88-10.89		4	9 430 610 007
				11.89-03.92		4	9 430 610 007
		55	RFH7	03.92-10.97		4	9 430 610 007
D Complex [GV]	2,0	60	RFH5				
			Fg.Nr. →308592	03.92-10.97		4	9 430 610 109
			Fg.Nr. 308592→	03.92-10.97		4	9 430 610 109
			RF83	03.88-10.89		4	9 430 610 064





MERCEDES-BENZ

Serie C									
200 D [202]	2,0	55-65	OM 604.915 <D 20>	09.96-06.99	CAV,EFZ	4	0 432 217 287	0 986 430 307	
220 D [202]	2,2	55-70	OM 604.910 <D 22>	08.93-06.99	CAV,EFZ	4	0 432 217 287	0 986 430 307	
250 D Turbo [202]	2,5	110	OM 605.960 <AD 25 LA>	09.95-04.00		5	0 432 217 280	0 986 430 388	
Serie C (T-Modell)									
200 D [202]	2,0	65	OM 604.915 <D 20>	09.96-06.99	CAV,EFZ	4	0 432 217 287	0 986 430 307	
220 D [202]	2,2	55-70	OM 604.910 <D 22>	05.96-06.99	CAV,EFZ	4	0 432 217 287	0 986 430 307	
250 D Turbo [202]	2,5	110	OM 605.960 <AD 25 LA>	05.96-02.01		5	0 432 217 280	0 986 430 388	
Serie E									
200 D [124]	2,0	55	OM 601.912						
			Mot.Nr. →..009929	07.93-06.95	AG	4	0 432 217 131	0 986 430 022	
			Mot.Nr. →..119225	07.93-06.95	GS	4	0 432 217 131	0 986 430 022	
			Mot.Nr. ..009930→	07.93-06.95	AG	4	0 432 217 161	0 986 430 172	
			Mot.Nr. ..119226→	07.93-06.95	GS	4	0 432 217 161	0 986 430 172	
D [210]	2,0	65	OM 604.917 <D20>	03.97-05.99	CAV,EFZ	4	0 432 217 287	0 986 430 307	
220 D [210]	2,2	55-70	OM 604.912 <D22>	06.95-05.99	CAV,EFZ	4	0 432 217 287	0 986 430 307	
250 D [124]	2,5	83	OM 605.911	07.93-06.95		5	0 432 217 253	0 986 430 245	
D [210]	2,5	83	OM 605.912 <D25>	06.95-05.99		5	0 432 217 253	0 986 430 245	
D Turbo [124]	2,5	93	OM 602.962	07.93-06.95		5	0 432 217 266	0 986 430 247	
D Turbo [210]	2,5	110	OM 605.962 <A D25 LA>	09.97-05.99		5	0 432 217 280	0 986 430 388	
290 D Turbo [210]	2,9	95	OM 602.982 <DE LA>						
			Mot.Nr. →..030404	01.96-05.99	GS	5	0 432 193 758		
						5	0 432 193 768 <sup>1</sup>		
			Mot.Nr. →..032988	01.96-05.99	AG	5	0 432 193 758		
						5	0 432 193 768 <sup>1</sup>		
			Mot.Nr. ..030405→	01.96-05.99	GS	5	0 432 193 637 <sup>1</sup>		
						5	0 432 193 639		
			Mot.Nr. ..032989→	01.96-05.99	AG	5	0 432 193 637 <sup>1</sup>		
						5	0 432 193 639		
300 D [124]	3,0	100	OM 606.910	07.93-06.95		6	0 432 217 253	0 986 430 245	
D [210]	3,0	100	OM 606.912	06.95-08.97		6	0 432 217 253	0 986 430 245	
D Turbo [124]	3,0	108	OM 603.960						
			Mot.Nr. →..017938	07.93-06.95		6	0 432 217 147		
			Mot.Nr. ..179939→	07.93-06.95		6	0 432 217 266	0 986 430 247	
D Turbo [210]	3,0	130	OM 606.962 <D30 LA>	03.97-05.99		6	0 432 217 280	0 986 430 388	
D Turbo 4MATIC [124]	3,0	108	OM 603.963						
			Mot.Nr. →..000831	07.93-06.95		6	0 432 217 147		
			Mot.Nr. ..000832→	07.93-06.95		6	0 432 217 266	0 986 430 247	
Serie E (T-Modell)									
250 D [124]	2,5	83	OM 605.911	07.93-05.96		5	0 432 217 253	0 986 430 245	
D [210]	2,5	83	OM 605.912 <D25>	05.96-06.98		5	0 432 217 253	0 986 430 245	
D Turbo [124]	2,5	93	OM 602.962	07.93-06.95		5	0 432 217 266	0 986 430 247	
D Turbo [210]	2,5	110	OM 605.962 <A D25 LA>	09.97-08.99		5	0 432 217 280	0 986 430 388	
290 D Turbo [210]	2,9	95	OM 602.982 <DE LA>						
			Mot.Nr. →..030404	05.96-05.99	GS	5	0 432 193 758		
						5	0 432 193 768 <sup>1</sup>		
			Mot.Nr. →..032988	05.96-05.99	AG	5	0 432 193 758		
						5	0 432 193 768 <sup>1</sup>		
			Mot.Nr. ..030405→	05.96-05.99	GS	5	0 432 193 637 <sup>1</sup>		
						5	0 432 193 639		
			Mot.Nr. ..032989→	05.96-05.99	AG	5	0 432 193 637 <sup>1</sup>		
						5	0 432 193 639		
300 D [124]	3,0	100	OM 606.910	07.93-05.96		6	0 432 217 253	0 986 430 245	
D Turbo [124]	3,0	105-108	OM 603.960						
			Mot.Nr. →..017938	07.93-05.96		6	0 432 217 147		
			Mot.Nr. ..017939→	07.93-05.96		6	0 432 217 266	0 986 430 247	
D Turbo [210]	3,0	130	OM 606.962 <D30 LA>	03.97-05.99		6	0 432 217 280	0 986 430 388	
D Turbo 4MATIC [124]	3,0	105-108	OM 603.963						
			Mot.Nr. →..000831	07.93-05.96		6	0 432 217 147		
			Mot.Nr. ..000832→	07.93-05.96		6	0 432 217 266	0 986 430 247	





◀ MERCEDES-BENZ

Serie G									
240 D [460]	2,4	53	OM 616.936						
			Mot.Nr. 000002→	03.79-08.87	AG	4	0 432 217 131	0 986 430 022	
			Mot.Nr. →..000001	03.79-08.87	AG	4	0 432 217 142	0 986 430 020	
			Mot.Nr. →..007549	03.79-08.87	GS	4	0 432 217 142	0 986 430 020	
			Mot.Nr. ...007550→	03.79-08.87	GS	4	0 432 217 131	0 986 430 022	
250 D [460]	2,5	62-69	OM 602.930	09.87-08.92		5	0 432 217 141	0 986 430 025	
D [463]	2,5	69	OM 602.931	09.89-07.93		5	0 432 217 157	0 986 430 197	
300 D [460]	3,0	65	OM 617.931						
			Mot.Nr. →..001875	12.79-08.91	AG	5	0 432 217 142	0 986 430 020	
			Mot.Nr. →..042201	12.79-08.91	GS	5	0 432 217 142	0 986 430 020	
			Mot.Nr. →..001876→	12.79-08.91	AG	5	0 432 217 131	0 986 430 022	
			Mot.Nr. ...042202→	12.79-08.91	GS	5	0 432 217 131	0 986 430 022	
D [463]	3,0	83	OM 603.931	09.89-07.97		6	0 432 217 157	0 986 430 197	
D Turbo [463]	3,0	130	OM 606.964	09.96-11.00		6	0 432 217 280	0 986 430 388	
350 D Turbo [463]	3,5	100	OM 603.972	09.91-06.96		6	0 432 217 266	0 986 430 247	
Serie S									
300 D Turbo [140]	3,0	130	OM 606.961	06.96-09.98		6	0 432 217 280	0 986 430 388	
SD Turbo [140]	3,5	100-110	OM 603.971	09.91-08.93		6	0 432 217 266	0 986 430 247	
SDL Turbo [126]	3,0	107-110	OM 603.961	11.85-08.87		6	0 432 217 147		
350 D Turbo [140]	3,5	100-110	OM 603.971	09.93-06.96		6	0 432 217 266	0 986 430 247	
SDL Turbo [126]	3,5	100	OM 603.970	03.90-06.91		6	0 432 217 266	0 986 430 247	
Serie V									
230 TD [638 TON]	2,3	72	OM 601.970						
			Mot.Nr. →..518371	04.96-09.03		4	0 432 217 290	0 986 430 505	
			Mot.Nr. ...518372→	04.96-09.03		4	0 432 217 266	0 986 430 247	
Serie 124									
200 D	2,0	53-55	OM 601.912						
			Mot.Nr. →..009929	12.84-06.93	AG	4	0 432 217 131	0 986 430 022	
			Mot.Nr. →..119225	12.84-06.93	GS	4	0 432 217 131	0 986 430 022	
			Mot.Nr. ...009930→	12.84-06.93	AG	4	0 432 217 161	0 986 430 172	
			Mot.Nr. ...119226→	12.84-06.93	GS	4	0 432 217 161	0 986 430 172	
250 D	2,5	66-69	OM 602.912						
			Mot.Nr. →..018671	04.85-06.93	AG	5	0 432 217 141	0 986 430 025	
			Mot.Nr. →..125558	04.85-06.93	GS	5	0 432 217 141	0 986 430 025	
			Mot.Nr. ...018672→	04.85-06.93	AG	5	0 432 217 157	0 986 430 197	
			Mot.Nr. ...125559→	04.85-06.93	GS	5	0 432 217 157	0 986 430 197	
D Turbo	2,5	93	OM 602.962	09.88-06.93		5	0 432 217 266	0 986 430 247	
300 D	3,0	80-83	OM 603.912						
			Mot.Nr. →..031254	01.85-06.93	AG	6	0 432 217 141	0 986 430 025	
			Mot.Nr. →..047922	01.85-06.93	GS	6	0 432 217 141	0 986 430 025	
			Mot.Nr. ...031255→	01.85-06.93	AG	6	0 432 217 157	0 986 430 197	
			Mot.Nr. ...047293→	01.85-06.93	GS	6	0 432 217 157	0 986 430 197	
D Turbo	3,0	105-108	OM 603.960						
			Mot.Nr. →..017938	09.86-06.93		6	0 432 217 147		
			Mot.Nr. ...017939→	09.86-06.93		6	0 432 217 266	0 986 430 247	
D Turbo 4MATIC	3,0	105/108	OM 603.963						
			Mot.Nr. →..000831	09.86-06.93		6	0 432 217 147		
			Mot.Nr. ...000832→	09.86-06.93		6	0 432 217 266	0 986 430 247	
D 4MATIC	3,0	80-83	OM 603.913	09.86-08.88		6	0 432 217 141	0 986 430 025	
				09.88-06.93		6	0 432 217 157	0 986 430 197	
Serie 124 (T-Modell)									
200 D	2,0	53-55	OM 601.912						
			Mot.Nr. →..009929	09.85-08.91	AG	4	0 432 217 131	0 986 430 022	
			Mot.Nr. →..119225	09.85-08.91	GS	4	0 432 217 131	0 986 430 022	
			Mot.Nr. ...009930→	09.85-08.91	AG	4	0 432 217 161	0 986 430 172	
			Mot.Nr. ...119226→	09.85-08.91	GS	4	0 432 217 161	0 986 430 172	
250 D	2,5	66-69	OM 602.912						
			Mot.Nr. →..018671	01.85-06.93	AG	5	0 432 217 141	0 986 430 025	
			Mot.Nr. →..125558	01.85-06.93	GS	5	0 432 217 141	0 986 430 025	
			Mot.Nr. ...018672→	01.85-06.93	AG	5	0 432 217 157	0 986 430 197	
			Mot.Nr. ...125559→	01.85-06.93	GS	5	0 432 217 157	0 986 430 197	
D Turbo	2,5	93	OM 602.962	09.90-06.93		5	0 432 217 266	0 986 430 247	





<b>300 D</b>	3,0	80/83	OM 603.912					
			Mot.Nr. →..031254	09.86-06.93	AG	6	<b>0 432 217 141</b>	<b>0 986 430 025</b>
			Mot.Nr. →..047922	09.86-06.93	GS	6	<b>0 432 217 141</b>	<b>0 986 430 025</b>
			Mot.Nr. ..031255→	09.86-06.93	AG	6	<b>0 432 217 157</b>	<b>0 986 430 197</b>
			Mot.Nr. ..047293→	09.86-06.93	GS	6	<b>0 432 217 157</b>	<b>0 986 430 197</b>
<b>D Turbo</b>	3,0	105-108	OM 603.960					
			Mot.Nr. →..017938	09.86-06.93		6	<b>0 432 217 147</b>	
			Mot.Nr. ..017939→	09.86-06.93		6	<b>0 432 217 266</b>	<b>0 986 430 247</b>
<b>D Turbo 4MATIC</b>	3,0	105/108	OM 603.963					
			Mot.Nr. →..000831	09.86-06.93		6	<b>0 432 217 147</b>	
			Mot.Nr. ..000832→	09.86-06.93		6	<b>0 432 217 266</b>	<b>0 986 430 247</b>
<b>Serie 190</b>								
<b>190 D 2.0 [201]</b>	2,0	53	OM 601.911	09.83-08.89		4	<b>0 432 217 131</b>	<b>0 986 430 022</b>
		55	OM 601.911	09.89-08.93		4	<b>0 432 217 161</b>	<b>0 986 430 172</b>
<b>2.5 [201]</b>	2,5	66	OM 602.911					
			Mot.Nr. →..014525	09.85-08.93	AG	5	<b>0 432 217 141</b>	<b>0 986 430 025</b>
			Mot.Nr. →..071586	09.85-08.93	GS	5	<b>0 432 217 141</b>	<b>0 986 430 025</b>
			Mot.Nr. ..014526→	09.85-08.93	AG	5	<b>0 432 217 157</b>	<b>0 986 430 197</b>
			Mot.Nr. ..071587→	09.85-08.93	GS	5	<b>0 432 217 157</b>	<b>0 986 430 197</b>
		69	OM 602.911	09.89-03.93		5	<b>0 432 217 157</b>	<b>0 986 430 197</b>
<b>2.5 Turbo [201]</b>	2,5	90/93	OM 602.961	09.86-08.93		5	<b>0 432 217 266</b>	<b>0 986 430 247</b>

**MG**

<b>ZR</b>								
<b>2.0 D Turbo</b>	2,0	74/82	20 T2N <L-Serie>	10.01-05.05		4	<b>0 432 193 571<sup>1</sup></b>	
						4	<b>0 432 193 601</b>	
<b>ZS</b>								
<b>2.0 TD</b>	2,0	74	20 T2N <L-Serie>	10.01-05.05		4	<b>0 432 193 571<sup>1</sup></b>	
						4	<b>0 432 193 601</b>	

**MITSUBISHI**

<b>Colt</b>								
<b>1.8 D [C1]</b>	1,8	44	4D65	11.83-05.86		4	<b>9 430 610 009</b>	
				06.86-06.88		4	<b>9 430 610 051</b>	
<b>Galant</b>								
<b>1.8 D Turbo [E1]</b>	1,8	60-63	4D65	05.84-05.86		4	<b>9 430 610 009</b>	
<b>L 200</b>								
<b>2.5 D, D 2WD, D 4WD [K6/K7]</b>	2,5	55-64	4D56	06.95-06.01		4	<b>9 430 612 750</b>	
<b>D Turbo Interc. 2WD [K6/K7]</b>	2,5	74-85	4D56	01.96-02.97	NOR	4	<b>9 430 610 179</b>	
				01.96-12.07	FBH	4	<b>9 430 613 643</b>	
				03.98-06.01	NOR	4	<b>9 430 612 750</b>	
				07.01-12.07	NOR	4	<b>9 430 610 179</b>	
<b>D Turbo Interc. 4WD [K6/K7]</b>	2,5	73-85	4D56	01.96-12.07	FBH	4	<b>9 430 613 643</b>	
					NOR	4	<b>9 430 610 179</b>	
<b>D Turbo 4WD, D 2WD [K0-K3]</b>	2,5	54/73	4D56	10.84-05.94		4	<b>9 430 610 154</b>	
				06.94-03.01		4	<b>9 430 610 179</b>	
<b>D 4WD [K0-K3]</b>	2,5	54/73	4D56	12.87-05.94		4	<b>9 430 610 154</b>	
<b>2.8 D [K6/K7]</b>	2,8	92	4M40	06.95→		4	<b>9 430 610 430</b>	
<b>L 200 Forte</b>								
<b>2.5 D Turbo Interc. [K7]</b>	2,5	73-85	4D56	01.97→	FBH	4	<b>9 430 613 643</b>	
					NOR	4	<b>9 430 610 179</b>	
<b>L 300</b>								
<b>2.3 D Wagon [L]</b>	2,3	49-50	4D55	06.84-10.86		4	<b>9 430 610 009</b>	
<b>L 300 Wagon</b>								
<b>2.5 D Turbo 4WD [P]</b>	2,5	62-64	4D56	12.87-05.95		4	<b>9 430 610 154</b>	
				06.95-05.96		4	<b>9 430 610 179</b>	
<b>D 2WD long, D 2WD short [P]</b>	2,5	51	4D56	11.86-06.94		4	<b>9 430 610 154</b>	
				07.94-12.00		4	<b>9 430 610 179</b>	





◀ MITSUBISHI

<b>L 400</b>						
2.5 D Turbo 2WD, D Turbo 4WD	2,5	64	4D56	12.94-03.01	4	9 430 610 179
<b>Lancer</b>						
1.8 D [C1/C3]	1,8	43	4D65	11.83-05.86	4	9 430 610 009
				06.86-06.88	4	9 430 610 051
<b>Lancer Station Wagon</b>						
1.8 D [C1/C3]	1,8	45	4D65	07.85-05.86	4	9 430 610 009
				06.86-05.88	4	9 430 610 051
<b>Pajero</b>						
2.3 TD [L]	2,3	62	4D55	09.84-04.86	4	9 430 610 009
2.5 TD [V]	2,5	62	4D56	04.91-05.95	4	9 430 610 154
				06.95-05.98	4	9 430 610 179
				06.98-05.99	4	9 430 612 750
TD Interc. [V]	2,5	73-77	4D56	12.90-06.00	WEG 4	9 430 610 154
					WEG 4	9 430 610 179
TD Interc. [V60; V70]	2,5	85	4D56	02.00-08.06	4	9 430 610 179
TD, TD Interc. [L]	2,5	62/70	4D56	05.86-06.91	4	9 430 610 154
2.8 D [V]	2,8	92	4M40	06.94-05.99	4	9 430 610 422
TD [V]	2,8	92	4M40	07.95-12.98	4	9 430 610 119
TD Interc. [V]	2,8	103	4M40	11.93-04.00	WEG 4	9 430 610 435
					WEG 4	9 430 610 119
3.2 DI-D 4WD [V60; V70]	3,2	118-121	4M41	02.00-08.06	4	9 430 613 989
<b>Pajero Cabrio</b>						
2.5 D [V]	2,5	62	4D56	04.91-05.95	4	9 430 610 154
				06.95-05.98	4	9 430 610 179
				06.98-05.99	4	9 430 612 750
TD Interc. [V]	2,5	73-77	4D56	12.90-05.94	4	9 430 610 154
				06.94-05.01	4	9 430 610 179
<b>Pajero Sport</b>						
2.5 TD, TD+ [K]	2,5	73-85/98	4D56	08.98-02.09	4	9 430 610 179
<b>Space Gear</b>						
2.5 D Turbo Interc. 2WD, D Turbo Interc. 4WD, D Turbo 2WD long, D Turbo 2WD short	2,5	64/73	4D56	06.94-03.01	4	9 430 610 179
<b>Space Wagon</b>						
1.8 D Turbo [D]	1,8	55	4D65	06.85-05.87	4	9 430 610 009
				06.87-05.88	4	9 430 610 051

**NISSAN**

<b>Almera Hatchback</b>						
2.0 D [N15]	2,0	55	CD20	07.95-04.96	4	9 430 610 132
				04.96-04.00	4	9 443 611 765 <sup>1</sup>
				05.96-04.00	4	9 430 610 386
2.2 D Turbo [N16E]	2,2	81	YD22DDT	01.00-03.01	4	9 430 613 823
				04.01-02.03	4	9 430 613 621
					WW 4	9 430 613 450
<b>Almera Sedan</b>						
2.0 D [N15]	2,0	55	CD20	07.95-04.96	4	9 430 610 132
				04.96-04.00	4	9 443 611 765 <sup>1</sup>
				05.96-04.00	4	9 430 610 386
2.2 D Turbo [N16E]	2,2	81	YD22DDT	03.01-02.03	4	9 430 613 621
					WW 4	9 430 613 450
<b>Almera Tino</b>						
2.2 D Turbo [V10M]	2,2	81-84	YD22DDTI	05.00-01.03	4	9 430 613 823
<b>Bluebird Hatchback</b>						
2.0 D [T12]	2,0	47-49	LD20	12.85-02.90	4	9 430 610 033
D [T72]	2,0	49	LD20	09.88-04.90	4	9 430 610 033
<b>Bluebird Kombi</b>						
2.0 D [U11]	2,0	43/49	LD20	11.83-05.90	4	9 430 610 037
D Turbo [U11]	2,0	55	LD20T	11.83-01.86	4	9 430 610 036





Bluebird Sedan						
2.0 D [T12]	2,0	47-49	LD20		12.85-02.90	4 9 430 610 033
D [T72]	2,0	49	LD20		09.88-04.90	4 9 430 610 033
D [U11]	2,0	43/49	LD20		11.83-04.90	4 9 430 610 037
D Turbo [U11]	2,0	55	LD20T		11.83-01.86	4 9 430 610 036
Cherry Hatchback						
1.7 D [N12]	1,7	40/45	CD17		06.84-05.86	4 9 430 610 029
Gloria						
2.8 D [430]	2,8	67	LD28		06.79-06.87	6 9 430 610 027
Hardbody						
2.5 D Turbo [D22]	2,5	98	YD25DDTI		01.06-06.08	4 9 430 613 778 <sup>1</sup>
D Turbo 4x4	2,5	98	YD25DDTI		05.08→	4 9 430 613 778 <sup>1</sup>
2.7 TD [D21]	2,7	76	TD27		05.02-06.06	4 9 430 615 042
Laurel						
2.8 D [C32]	2,8	62-67	LD28		01.85-02.87	6 9 430 610 035
		70	RD28		02.87-10.90	6 9 430 610 033
Patrol						
2.8 D, D Turbo [260]	2,8	57/70	A428II; A428T		04.89-05.98	4 9 430 610 033
		80/85	RD28; RD28T		04.89-05.98	6 9 430 610 037
3.2 D, D Turbo [260]	3,2	70/81-88	SD33; SD33T		06.85-03.89	6 9 430 610 006
3.3 D [160]	3,3	70	SD33		08.83-08.88	6 9 430 610 006
D Turbo [160]	3,3	81/89	SD33T		07.83-08.88	6 9 430 610 006
Patrol GR						
2.8 D Turbo [Y60]	2,8	85	RD28T		09.88-09.97	6 9 430 610 033
D Turbo, D Turbo 4x4 [Y61]	2,8	95-96	RD28TI		10.97→	6 9 430 610 297
						6 9 443 610 422 <sup>1</sup>
3.0 Di Hardtop 4x4, Di 4x4 [Y61]	3,0	116	ZD30DDTI		02.00-07.01	4 9 430 613 211
					08.01-07.04	4 9 430 613 871
					08.04-03.10	4 9 430 613 801
4.2 D [Y60]	4,2	92	TD42		08.87-09.97	6 9 430 610 065
Pickup						
2.3 D [D21]	2,3	51	SD23		09.85-08.87	4 9 430 610 056
2.5 D, D 4WD [D21]	2,5	53/57	SD25		09.85-08.87	4 9 430 610 054
		59-63	TD25		08.87-02.98	4 9 430 610 065
D Turbo, D Turbo 4WD [D22]	2,5	98	YD25		11.01-01.08	4 9 430 613 778 <sup>1</sup>
2.7 D, D 4WD [D21]	2,7	73	TD27		08.87-01.97	4 9 430 610 048
D 2WD, D 4WD [D21]	2,7	62	TD27		08.87-10.95	4 9 430 610 065
Primera Hatchback						
2.0 D [P10E]	2,0	55	CD20		01.91-10.91	4 9 430 610 098
					11.91-09.94	4 9 430 610 105
					10.94-06.96	4 9 430 610 132
D Turbo [P11E]	2,0	66	CD20T		06.96-09.97	4 9 430 610 294
					10.97-12.01	4 9 443 611 288 <sup>1</sup>
						4 0 432 217 308
						4 0 432 217 309 <sup>1</sup>
Primera Sedan						
2.0 D [P10E]	2,0	55	CD20		01.91-10.91	4 9 430 610 098
					11.91-09.94	4 9 430 610 105
					10.94-06.96	4 9 430 610 132
D Turbo [P11E]	2,0	66	CD20T		06.96-09.97	4 9 430 610 294
					10.97-12.01	4 9 443 611 288 <sup>1</sup>
						4 0 432 217 308
						4 0 432 217 309 <sup>1</sup>
Primera Wagon						
2.0 D [W10]	2,0	55	CD20		07.90-12.90	4 9 430 610 098
					01.91-09.91	4 9 430 610 105
					10.91-11.91	4 9 430 610 131
					12.91-02.94	4 9 430 610 105
					03.94-04.96	4 9 430 610 132
D Turbo [WP11E]	2,0	66	CD20T		01.98-12.01	4 0 432 217 308
						4 0 432 217 309 <sup>1</sup>





◀ NISSAN

Pulsar Hatchback							
1.7 D [N12]	1,7	45	CD17	04.82-05.86	4	9 430 610 029	
D [N13]	1,7	41	CD17	06.86-08.90	4	9 430 610 029	
Serena							
2.0 D [C23M]	2,0	49	LD20	07.92-09.94	4	9 430 610 059	
2.3 D [C23M]	2,3	55	LD23	09.94-11.01	4	0 432 117 001	
Sunny Hatchback							
1.7 D [N13]	1,7	40	CD17	06.86-08.90	4	9 430 610 029	
2.0 D [N14]	2,0	55	CD20	10.90-12.90	4	9 430 610 098	
				01.91-09.91	4	9 430 610 105	
				10.91-11.91	4	9 430 610 131	
				12.91-05.95	4	9 430 610 105	
			10.92-05.95	4	9 430 610 105		
Sunny Sedan							
1.7 D [B11]	1,7	40	CD17	02.83-05.88	4	9 430 610 029	
		45	CD17	03.82-05.88	4	9 430 610 029	
	D [B12]	1,7	40	CD17	01.86-04.90	4	9 430 610 029
	D [N13]	1,7	40	CD17	06.86-08.90	4	9 430 610 029
2.0 D [N14]	2,0	55	CD20	10.90-12.90	4	9 430 610 098	
				01.91-09.91	4	9 430 610 105	
				10.91-11.91	4	9 430 610 131	
				12.91-05.95	4	9 430 610 105	
Sunny Wagon							
1.7 D [B11]	1,7	40	CD17	02.83-05.88	4	9 430 610 029	
		45	CD17	03.82-05.88	4	9 430 610 029	
	D [B12]	1,7	40	CD17	01.86-09.90	4	9 430 610 029
	D [Y10]	1,7	40	CD17 <VA>	05.92-04.98	4	9 430 610 098
2.0 D [Y10]	2,0	55	CD20 <VC>	11.90-03.00	4	9 430 610 105	
Terrano I							
2.7 D, D Turbo [WD21]	2,7	62/73	TD27; TD27T	08.87-11.95	4	9 430 610 065	
Terrano II							
2.7 D Turbo 4x4 [R20]	2,7	74	TD27T	02.93-05.96	4	9 430 610 125	
				04.99-02.02	4	9 430 610 125	
		92	TD27TI	01.96-02.02 DKF	4	9 430 610 170	
					4	9 443 610 385 <sup>1</sup>	
				01.96-12.06 BO	4	0 432 217 306 <sup>1</sup>	
				11.96-10.97	4	9 430 610 125	
					4	9 443 610 385 <sup>1</sup>	
				11.97-12.06 BO	4	0 432 217 305	
				11.97→	4	0 432 217 305	
					4	0 432 217 306 <sup>1</sup>	
			11.98-12.99	4	0 432 217 306 <sup>1</sup>		
			01.00→	4	9 430 610 125		
				4	9 443 610 385 <sup>1</sup>		
3.0 D Turbo 4x4 [R20]	3,0	113	ZD30	02.02-12.06	4	9 430 613 871	
Urvan							
3.0 DD ZDI Diesel	3,0	78	ZD30E	02.02→	4	9 430 613 873	
Xterra							
2.8 D	2,8	97	4.07 TCA <Euro 2>	02.03-07.05	4	0 432 193 566	

**OPEL**

Ascona						
1.6 D [C]	1,6	40	16 D, 16 DA	Mot.Nr. →14350830	03.82-08.88	4 0 432 217 082
				Mot.Nr. 14350831→	03.82-08.88	4 0 432 217 156
Astra						
1.7 D [F]	1,7	42-44	17 D/DR <OHC>	12.91-08.94 BO	4	0 432 217 299 0 986 430 449
DT [G]	1,7	50	X 17 DTL <Turbo>	03.98-08.00	4	0 432 217 299 0 986 430 449
TD [F]	1,7	50	X 17 DTL <OHC>	09.94-02.98 BO	4	0 432 217 299 0 986 430 449
				12.91-02.98 DKF	4	9 430 610 128 0 986 433 002





2.0 DT [G]	2,0	60	X 20 DTL <Turbo>	03.98-08.00	EU2,NC8	4	0 432 193 686	
					EU3,NT5	4	0 432 193 633	
DTI [G]	2,0	74	Y 20 DTH <Turbo>					
			Fg.Nr. →22999999 → 25999999 → 28999999 → 2H999999	09.99-01.05		4	0 432 193 634	
			Fg.Nr. 32000001 → 35000001 → 38000001 → 3H000001 →	09.99-01.05		4	0 432 193 525	
DTL [G]	2,0	60	Y 20 DTL <Turbo>	09.00-01.04	EU3,NT5	4	0 432 193 633	
2.2 DTI [G]	2,2	92	Y 22 DTR <Turbo>	09.01-01.04		4	0 432 193 569	
<b>Astra Cabrio</b>								
2.2 DTI [G]	2,2	92	Y 22 DTR <Turbo>	03.02-08.05		4	0 432 193 569	
<b>Astra Caravan</b>								
1.7 D [F]	1,7	42-44	17 D/DR <OHC>	12.91-08.94	BO	4	0 432 217 299	0 986 430 449
DT [G]	1,7	50	X 17 DTL <Turbo>	03.98-08.00		4	0 432 217 299	0 986 430 449
TD [F]	1,7	50	X 17 DTL <OHC>	09.94-02.98	BO	4	0 432 217 299	0 986 430 449
		60	17 TD/TC4 <OHC EE1>	12.91-02.98	DKF	4	0 430 610 128	0 986 433 002
2.0 DT [G]	2,0	60	X 20 DTL <Turbo>	03.98-08.00	EU2,NC8	4	0 432 193 686	
					EU3,NT5	4	0 432 193 633	
DTI [G]	2,0	74	Y 20 DTH <Turbo>					
			Fg.Nr. →22999999 →25999999 →28999999 →2H999999	09.00-06.04		4	0 432 193 634	
			Fg.Nr. 32000001 → 35000001 → 38000001 → 3H000001 →	09.00-06.04		4	0 432 193 525	
DTL [G]	2,0	60	Y 20 DTL <Turbo>	09.00-06.04	EU3,NT5	4	0 432 193 633	
2.2 DTI [G]	2,2	92	Y 22 DTR <Turbo>	09.01-06.04		4	0 432 193 569	
<b>Astra Coupé</b>								
2.2 DTI [G]	2,2	92	Y 22 DTR <Turbo>	03.02-02.05		4	0 432 193 569	
<b>Campo Pick-Up</b>								
2.2 D [TF0]	2,2	39-45	4 FD1	08.87-09.96	DKF	4	0 430 610 031	
					DKF,EFV	4	0 430 610 145	
2.5 D [TF0]	2,5	56	4 JA1	06.90-09.92	DKF	4	0 430 610 086	
				10.92-08.97	DKF,EFV	4	0 430 610 138	
TD [TF0]	2,5	56	4 JA1 T	10.89-08.97	DKF,EFV	4	0 430 610 155	
				07.94-01.97	DKF	4	0 430 610 139	
3.1 TD [TF0]	3,1	80	4 JG2 T	03.95-03.96	DKF	4	0 430 610 140	
				04.96-08.97	DKF	4	0 430 610 141	
<b>Combo</b>								
1.7 D	1,7	44	X 17 D 4EE1					
			Mot.Nr. →602344	04.96-10.01		4	0 430 610 136	
			Mot.Nr. 602345 →	04.96-10.01		4	0 430 610 136	
			17 D <4EE1>					
			Mot.Nr. →602344	09.94-10.01		4	0 430 610 136	
<b>Corsa</b>								
1.5 D [B]	1,5	37	15 D <4EC1>					
			Mot.Nr. →957024	03.93-08.00	DKF	4	0 430 610 136	
			Mot.Nr. 957025 →	03.93-08.00	DKF	4	0 430 610 136	
D, TD [A]	1,5	37/49	15 D <4EC1-AAD OHC>; 15 DT/T4EC1-AA DT	09.87-03.93	DKF	4	0 430 610 045	
						4	0 430 610 060	
TD [B]	1,5	49	15 TD <T4EC1 Turbo>					
			Mot.Nr. →957024	03.93-08.00	DKF	4	0 430 610 136	
			Mot.Nr. 957025 →	03.93-08.00	DKF	4	0 430 610 136	
XD [B]	1,5	37	X 15 D <4EC1>					
			Mot.Nr. →957024	04.96-08.00	DKF	4	0 430 610 136	
			Mot.Nr. 957025 →	04.96-08.00	DKF	4	0 430 610 136	
XTD [B]	1,5	49	X 15 TD <4EE1 Turbo>					
			Mot.Nr. →957024	04.96-08.00	DKF	4	0 430 610 136	
			Mot.Nr. 957025 →	04.96-08.00	DKF	4	0 430 610 136	
1.7 D [B]	1,7	44	X 17 D <4EE1>					
			Mot.Nr. →602344	04.96-08.00		4	0 430 610 136	
			Mot.Nr. 602345 →	04.96-08.00		4	0 430 610 136	
			17 D <4EE1>					
			Mot.Nr. →602344	03.93-08.00		4	0 430 610 136	
D Utility [B]	1,7	42	X 17 D4EE1	09.98-12.00		4	0 430 613 598	





◀ OPEL

<b>170 D Utility [B]</b>	1,7	42	X 17 D	09.00-12.00	4	<b>9 430 613 598</b>
<b>Frontera</b>						
<b>2.2 DTI [B]</b>	2,2	85/88	X 22 DTH <Turbo>; Y 22 DTH <Turbo>	09.98-09.04	4	<b>0 432 193 650</b>
<b>2.3 TD [A]</b>	2,3	74	23 DT <Turbo>	09.91-08.95	4	<b>0 432 217 196</b>
<b>2.5 TDS Turbo [A]</b>	2,5	85	VM 41 B <Venturi-25TD>	06.96-08.98	0	<b>0 432 217 222 0 986 430 249</b>
					0	<b>0 432 217 249<sup>1</sup></b>
<b>2.8 TDI [A]</b>	2,8	83	4JB1T <(28TD)>	02.95-08.98	DKF	4 <b>9 430 610 163</b>
					DKF,EFV	4 <b>9 430 610 163</b>
<b>Kadett</b>						
<b>1.5 TD [E]</b>	1,5	53	15 DT <T4EC1>	09.88-08.91	DKF	4 <b>9 430 610 045</b>
						4 <b>9 430 610 060</b>
<b>1.6 D [E]</b>	1,6	40	16 D, DA <OHC>			
			Mot.Nr. →14350830	09.84-01.89	4	<b>0 432 217 082</b>
			Mot.Nr. 14350831→	09.84-01.89	4	<b>0 432 217 156</b>
<b>1.7 D/DR [E]</b>	1,7	42	17 D/DR <OHC>	02.89-08.91	4	<b>0 432 217 197</b>
TD [E]	1,7	60	17 DT /TC4 EE1	02.90-08.91	DKF	4 <b>9 430 610 128 0 986 433 002</b>
<b>Monterey</b>						
<b>3.1 TD [A]</b>	3,1	84	4 JG2 TC <OHV>	CH 09.92-08.93	4	<b>9 430 610 121</b>
				09.91-08.92	4	<b>9 430 610 121</b>
				09.92-08.93	RLE	4 <b>9 430 610 122</b>
				09.93-03.96	4	<b>9 430 610 122</b>
				04.96-12.97	4	<b>9 430 610 141</b>
				CH 09.92-08.93	LLE	4 <b>9 430 610 141</b>
<b>Omega</b>						
<b>2.0 DTI Turbo [B]</b>	2,0	74	X 20 DTH	09.97-08.00	NT5	4 <b>0 432 193 634</b>
<b>2.2 DTI [B]</b>	2,2	88	Y 22 DTH <Turbo>	06.00-07.03	4	<b>0 432 193 570</b>
<b>2.3 D [A]</b>	2,3	54	23 YD			
			Fg.Nr. K1000099→	09.86-03.94	4	<b>0 432 217 196</b>
			Fg.Nr. →K1000098	09.86-03.94	4	<b>0 432 217 171</b>
TD [A]	2,3	66	23 YDT			
			Fg.Nr. K 1000099→	09.86-08.88	4	<b>0 432 217 196</b>
			Fg.Nr. →K 1000098	09.86-08.88	4	<b>0 432 217 133</b>
		74	23 DTR			
			Fg.Nr. K 1000099→	09.88-03.94	4	<b>0 432 217 196</b>
			Fg.Nr. →K 1000098	09.88-03.94	4	<b>0 432 217 133</b>
<b>2.5 TD [B]</b>	2,5	96	U 25 TD	04.94-07.96	6	<b>0 432 217 223 0 986 430 241</b>
					6	<b>0 432 217 236<sup>1</sup></b>
				08.96-02.01	6	<b>0 432 217 278 0 986 430 302</b>
					6	<b>0 432 217 279<sup>1</sup></b>
			X 25 TD	04.96-07.96	6	<b>0 432 217 223 0 986 430 241</b>
					6	<b>0 432 217 236<sup>1</sup></b>
				08.96-11.00	6	<b>0 432 217 278 0 986 430 302</b>
					6	<b>0 432 217 279<sup>1</sup></b>
<b>Rekord</b>						
<b>2.3 D [E]</b>	2,3	52	23 D	05.83-08.86	4	<b>0 432 217 126</b>
TD [E]	2,3	63	23 DT	06.84-08.86	4	<b>0 432 217 133</b>
<b>Senator</b>						
<b>2.3 D Comprex [A]</b>	2,3	70	23 DC	11.84-08.87	4	<b>0 432 217 160</b>
TD [A]	2,3	64	23 TD	11.84-08.87	4	<b>0 432 217 133</b>
<b>Signum</b>						
<b>2.0 DTI</b>	2,0	74	Y 20 DTH <Ecotec>	05.03-09.05	4	<b>0 432 193 525</b>
<b>2.2 DTI</b>	2,2	86-92	Y 22 DTR <Ecotec>	05.03-09.05	4	<b>0 432 193 570</b>
<b>Sintra</b>						
<b>2.2 TD</b>	2,2	85	X 22 DTH <Turbo>	09.97-10.98	4	<b>0 432 193 688</b>
<b>Vectra</b>						
<b>1.7 D [A]</b>	1,7	42	17 D/DR			
			Mot.Nr. →14363650	10.88-08.95	BO	4 <b>0 432 217 197</b>
			Mot.Nr. 14363651→	10.88-08.95	BO	4 <b>0 432 217 299 0 986 430 449</b>
TD [A]	1,7	60	X 17 DT <TC4 EE1>	03.90-08.95	DKF	4 <b>9 430 610 128 0 986 433 002</b>
TD [B]	1,7	60	X 17 TD <TC4 EE1>; X 17 TD <TC4 EE1 Turbo>	09.95-09.98	DKF	4 <b>9 430 610 128</b>



<b>2.0 DI [B]</b>	2,0	60	X 20 DTL <Ecotec 16V Turbo>				
			Fg.Nr. XL000001→	09.96-08.00	4	<b>0 432 193 686</b>	
			Fg.Nr. X1000001→	09.96-08.00	4	<b>0 432 193 633</b>	
			Mot.Nr. →17062265	09.96-08.00	4	<b>0 432 193 797</b>	
			Mot.Nr. 17062266→				
			Fgst.Nr.W7999999	09.96-08.00	4	<b>0 432 193 686</b>	
			X 20 DTL 16V Turbo <Ecotec>				
			Fg.Nr. XL000001→	09.96-08.02	4	<b>0 432 193 686</b>	
			Fg.Nr. X1000001→	09.96-08.02	4	<b>0 432 193 633</b>	
			Mot.Nr. →17062265	09.96-08.02	4	<b>0 432 193 797</b>	
			Mot.Nr. 17062266→				
			Fgst.Nr.W7999999	09.96-08.02	4	<b>0 432 193 686</b>	
<b>DTI [B]</b>	2,0	74	X 20 DTH				
			Fg.Nr. XL000001→	09.97-08.03	4	<b>0 432 193 687</b>	
			Fg.Nr. X1000001→X7000001→	09.97-08.03	4	<b>0 432 193 634</b>	
			Mot.Nr. 17062266→	09.97-08.03	4	<b>0 432 193 687</b>	
			Fgst.Nr.W7999999				
			Y 20 DTH				
			Fg.Nr. XL000001→	09.00-09.03	4	<b>0 432 193 686</b>	
			Fg.Nr. X1000001→	09.00-09.03	4	<b>0 432 193 633</b>	
			Mot.Nr. →17062265	09.00-09.03	4	<b>0 432 193 797</b>	
			Mot.Nr. 17062266→	09.00-09.03	4	<b>0 432 193 686</b>	
			Fgst.Nr.W7999999				
<b>DTI, DTI GTS [C]</b>	2,0	74	Y 20 DTH <Ecotec>	04.02-09.05	4	<b>0 432 193 525</b>	
<b>2.2 DTI [B]</b>	2,2	92	Y 22 DTR <Ecotec>	09.00-09.03	4	<b>0 432 193 569</b>	
<b>DTI, DTI GTS [C]</b>	2,2	86-92	Y 22 DTR <Turbo Ecotec>	04.02-09.05	4	<b>0 432 193 569</b>	
<b>Vectra Caravan</b>							
<b>1.7 TD [B]</b>	1,7	60	X 17 TD <TC4 EE1 Turbo>	09.95-09.98	DKF	4	<b>9 430 610 128</b>
<b>2.0 DI [B]</b>	2,0	60	X 20 DTL <16V Turbo Ecotec>				
			Fg.Nr. XL000001→	09.96-08.00	4	<b>0 432 193 686</b>	
			Fg.Nr. X1000001→	09.96-08.00	4	<b>0 432 193 633</b>	
			Mot.Nr. →17062265	09.96-08.00	4	<b>0 432 193 797</b>	
			Mot.Nr. 17062266→	09.96-08.00	4	<b>0 432 193 686</b>	
			Fgst.Nr.W7999999				
<b>DTI [B]</b>	2,0	74	X 20 DTH				
			Fg.Nr. XL000001→	09.97-08.03	4	<b>0 432 193 687</b>	
			Fg.Nr. X1000001→X7000001→	09.97-08.03	4	<b>0 432 193 634</b>	
			Mot.Nr. 17062266→	09.97-08.03	4	<b>0 432 193 687</b>	
			Fgst.Nr.W7999999				
			Y 20 DTH				
			Fg.Nr. XL000001→	09.00-09.03	4	<b>0 432 193 686</b>	
			Fg.Nr. X1000001→	09.00-09.03	4	<b>0 432 193 633</b>	
			Mot.Nr. →17062265	09.00-09.03	4	<b>0 432 193 797</b>	
			Mot.Nr. 17062266→	09.00-09.03	4	<b>0 432 193 686</b>	
			Fgst.Nr.W7999999				
<b>DTI [C]</b>	2,0	74	Y 20 DTH <Turbo Ecotec>	09.03-09.05	4	<b>0 432 193 525</b>	
<b>2.2 DTI [B]</b>	2,2	92	Y 22 DTR <Ecotec>	09.00-09.03	4	<b>0 432 193 569</b>	
<b>DTI [C]</b>	2,2	86-92	Y 22 DTR <Turbo Ecotec>	09.03-09.05	4	<b>0 432 193 569</b>	
<b>Zafira</b>							
<b>2.0 DI [A]</b>	2,0	60	X 20 DTL <Turbo>	03.99-08.00	EU2,NC8	4	<b>0 432 193 686</b>
					EU3,NT5	4	<b>0 432 193 633</b>
<b>DTI [A]</b>	2,0	74	Y 20 DTH <Turbo>				
			Fg.Nr. →22999999→25999999	04.99-07.05	4	<b>0 432 193 634</b>	
			→28999999→2H999999				
			Fg.Nr. 32000001→35000001→	04.99-07.05	4	<b>0 432 193 525</b>	
			38000001→3H000001→				
<b>2.2 DTI [A]</b>	2,2	92	Y 22 DTR <Turbo>	03.02-07.05	4	<b>0 432 193 569</b>	





**PEUGEOT**

Expert						
1.9 D Turbo [U64]	1,9	66-68	DHX <XUD9TE>	09.95-05.00	4	0 432 217 286 <sup>1</sup>
		68	D8B <XUD9TE>	09.95-07.98	4	0 432 217 289 0 986 430 375
P 4						
2.5 D	2,5	56	155 PB <XD3> Mot.Nr. →PB 011323	10.86-12.96	4	0 432 217 108
Partner						
1.9 D	1,9	51	DW8	10.99→	4	0 432 217 310
D [M4]	1,9	50	DJY <XUD9Y>	07.96-08.02 BO	4	0 432 217 248 0 986 430 244
		51	WJZ <DW8>	11.98-08.02 BO	4	0 432 217 310
Ranch						
1.9 D [M4]	1,9	51	WJZ <DW8>	11.98-08.02 BO	4	0 432 217 310
106						
1.5 D [S1]	1,5	40-42	VJY <TUD5>; VJZ <TUD5>	07.94-04.96 BO	4	0 432 217 288
D [S2]	1,5	40-42	VJY <TUD5>; VJZ <TUD5>	05.96-05.05 BO	4	0 432 217 288
		42	VJX <TUD5B>	07.00-05.05	4	0 432 217 310
205						
1.8 D	1,8	44	A9A,161A <XUD7>; R171-1 <XUD7>	10.85-12.98 BO	4	0 432 217 153
1.9 D	1,9	47	DJZ,162 <XUD9>	10.87-09.98 BO	4	0 432 217 153
205 Pickup						
1.8 D	1,8	44	<XUD7>	10.85-09.98 BO	4	0 432 217 153
305						
1.8 D	1,8	44	161A <XUD7>	10.82-06.88 BO	4	0 432 217 153
1.9 D	1,9	48	162,D9A <XUD9>	05.85-07.90 BO	4	0 432 217 153
306						
1.8 D [N3]	1,8	44	A9A <XUD7>; 161A <XUD7>	05.93-04.97 BO	4	0 432 217 153
1.9 D	1,9	50	<XUD9>	10.97→	4	0 432 217 248 0 986 430 244
D [N3]	1,9	47-48	DJZ <XUD9Y>	05.93-06.94 BO	4	0 432 217 153
		50/51	DJY <XUD9Y>; D9B <XUD9A>	05.93-04.97 BO	4	0 432 217 248 0 986 430 244
D [N5]	1,9	50/51	DJY <XUD9>; D9B <XUD9>	05.97-10.03 BO	4	0 432 217 248 0 986 430 244
		51	WJZ <DW8>	09.98-10.03 BO	4	0 432 217 310
D Turbo [N3]	1,9	66-67/68	DHY <XUD9TE>; D8A <XUD9TE>	05.93-04.97 BO	4	0 432 217 218 0 986 430 240
D Turbo [N5]	1,9	55	DHW <XUD9BSD>	06.98-10.03	4	0 432 217 248 0 986 430 244
306 Break						
1.9 D [N5]	1,9	50/51	DJY <XUD9>; D9B <XUD9>	05.97-03.02 BO	4	0 432 217 248 0 986 430 244
		51	WJZ <DW8>	09.98-03.02 BO	4	0 432 217 310
D Turbo [N5]	1,9	55	DHV <XUD9BSD>	06.98-03.02	4	0 432 217 248 0 986 430 244
309						
1.8 D	1,8	44	161A,A9A <XUD7>	06.86-12.93 BO	4	0 432 217 153
1.9 D	1,9	47	DJZ <XUD9Y>; 162,D9A <XUD9>	06.86-12.93 BO	4	0 432 217 153
405						
1.8 D Turbo [15]	1,8	64-66	AJZ <XUD7TEY>	10.90-12.92 BO,KAT	4	0 432 217 228
			A8A,A8B <XUD7TE>	03.88-12.92 BO	4	0 432 217 200
1.9 D	1,9	50	XUD9	03.95→	4	0 432 217 248 0 986 430 244
		66/68	D8A <XUD9TE>; XUD9T	04.96→	4	0 432 217 218 0 986 430 240
D [4]	1,9	47	DJZ <XUD9Y>	06.92-06.94 BO	4	0 432 217 153
		50/51-52	DJY <XUD9Y>; D9B <XUD9A>	06.92-04.97 BO	4	0 432 217 248 0 986 430 244
D [15]	1,9	47	DJZ <XUD9Y>	07.88-09.92 AGF,BO	4	0 432 217 153
		51	D9B <XUD9A>	03.88-12.92 BO	4	0 432 217 201
D Turbo [4]	1,9	66-68	DHY <XUD9TE Kat.>; D8A <XUD9TE>	06.92-04.97 BO	4	0 432 217 218 0 986 430 240
405 Break						
1.8 D Turbo [15]	1,8	64-66	AJZ <XUD7TEY>	10.90-12.92 BO,KAT	4	0 432 217 228
			A8A,A8B <XUD7TE>	07.88-12.92 BO	4	0 432 217 200
1.9 D [4]	1,9	47	DJZ <XUD9Y>	06.92-06.94 BO	4	0 432 217 153
		50/51-52	DJY <XUD9Y>; D9B <XUD9A>	06.92-04.97 BO	4	0 432 217 248 0 986 430 244
D [15]	1,9	47	DJZ <XUD9Y>	07.88-09.92 AGF,BO	4	0 432 217 153
		51	D9B <XUD9A>	07.88-12.92 BO	4	0 432 217 201
D Turbo [4]	1,9	66-68	DHY <XUD9TE Kat.>; D8A <XUD9TE>	06.92-04.97 BO	4	0 432 217 218 0 986 430 240





<b>406</b>							
1.9 D Turbo [D8]	1,9	66-68	DHX <XUD9TE>	12.95-03.99	4	0 432 217 286 <sup>1</sup>	
			D8B <XUD9TE>	12.95-03.99	4	0 432 217 289	0 986 430 375
<b>406 Break</b>							
1.9 D Turbo [D8]	1,9	66-68	DHX <XUD9TE>	10.96-03.99	4	0 432 217 286 <sup>1</sup>	
			D8B <XUD9TE>	10.96-03.99	4	0 432 217 218	0 986 430 240
<b>504 Pickup</b>							
2.5 D	2,5	55	<XD3>	07.87-12.89	4	0 432 217 108	
<b>505</b>							
2.3 D	2,3	44-51	<XD2>	05.81-09.86	4	0 432 217 087	
D Turbo	2,3	54-59	147 <XD2S> Fg.Nr. 1322319→	10.82-06.86 BO	4	0 432 217 090	
2.5 D	2,5	51-56	155 <XD3>	06.81-12.93 BO	4	0 432 217 108	
D Turbo	2,5	66-70	152A, 152Y <XD3T>	10.84-12.93	4	0 432 217 136 <sup>1</sup>	
				BO	4	0 432 217 137	
		77	152B <XD3TE>	10.86-12.93 BO	4	0 432 217 150	
				BO,CSA	4	0 432 217 151 <sup>1</sup>	
<b>604</b>							
2.5 D Turbo	2,5	66-70	152A <XD3T> Fg.Nr. 6647668→	06.83-06.86	4	0 432 217 090	
<b>605</b>							
2.1 D [Y30]	2,1	60-61	PJZ <XUD11A>	06.92-06.94 BO	4	0 432 217 234	
			P9A <XUD11A>	06.89-06.94 BO	4	0 432 217 234	
D Turbo [Y30]	2,1	80-81	PHZ <XUD11ATE>; P8A <XUD11ATE>	06.89-09.96 AGF,BO	4	0 432 217 218	0 986 430 240
				BO	4	0 432 217 235	
			P8B <XUD11ATE>	06.92-09.96 AGF,BO	4	0 432 217 218	0 986 430 240
				BO	4	0 432 217 235	
2.5 D Turbo [Y30]	2,5	94-96	THY <DK5ATE>	07.94-05.99	4	0 432 217 269	
					4	0 432 217 270 <sup>1</sup>	
<b>806</b>							
1.9 D Turbo [U60]	1,9	66	DHX <XUD9TE>	12.94-08.02	4	0 432 217 286 <sup>1</sup>	
					4	0 432 217 289	0 986 430 375
		66-68	D8B <XUD9TE>	12.94-08.02	4	0 432 217 218	0 986 430 240
<b>RENAULT</b>							
<b>Clio I</b>							
1.9 D	1,9	47	F8Q 732	03.96→	4	0 432 217 250	
D [X57]	1,9	47	F8Q 678	10.94-02.98 BO	4	0 432 217 226	
			F8Q 732	06.90-02.98 BO	4	0 432 217 226	
		47-48	F8Q 730	06.90-03.96 BO	4	0 432 217 258	
				06.90-02.98 BO	4	0 432 217 258	
<b>Clio II</b>							
1.9 D TI [BB./CB./SB.]	1,9	59	F9Q 780	03.99-10.07	4	0 432 193 643	
			F9Q 782	08.00-10.07	4	0 432 193 644 <sup>1</sup>	
					4	0 432 193 563 <sup>1</sup>	
					4	0 432 193 564	
<b>Espace I</b>							
2.1 D Turbo [J11/13]	2,1	65	J8S 240; J8S 774	10.84-12.90	4	0 432 297 050	
<b>Espace II</b>							
2.1 D Turbo [J63]	2,1	65/66	J8S 610; J8S 612; J8S 778	06.92-09.96	4	0 432 217 237	0 986 430 270
D Turbo, D Turbo 4x4 [J63]	2,1	65	J8S 772; J8S 776	01.91-09.96	4	0 432 297 050	
<b>Espace III</b>							
1.9 dTi [JE0]	1,9	72	F9Q 720	02.99-10.02	4	0 432 193 753	
			F9Q 722	10.99-10.02	4	0 432 193 754 <sup>1</sup>	
					4	0 432 193 610 <sup>1</sup>	
					4	0 432 193 611	
2.2 D Turbo [JE0]	2,2	83	G8T 714	10.96-10.02	4	0 432 217 285	
					4	0 432 217 307 <sup>1</sup>	





◀ RENAULT

Express, Extra, Rapid							
1.6 D [F40]	1,6	40	F8M 720; F8M 730; F8M 736; F8M 760	03.86-03.97	BO	4	0 432 217 099
1.9 D [F40]	1,9	40	F8Q 682	04.97-09.97		4	0 432 217 226
		40/47-48	F8Q 640; F8Q 724,732	09.91-10.97		4	0 432 217 226
		47-48	F8Q 646	06.96-03.97	BO	4	0 432 217 292
			F8Q 680	04.97-09.97	BO	4	0 432 217 292
			F8Q 684	04.97-09.97		4	0 432 217 258
			F8Q 776,730	09.91-03.97		4	0 432 217 258
Kangoo I							
1.9 DTI [FC./KC.]	1,9	59	F9Q 780	09.98-12.07		4	0 432 193 643
						4	0 432 193 644 <sup>1</sup>
			DTI, DTI 4x4 [FC./KC.]	02.00-12.07		4	0 432 193 563 <sup>1</sup>
						4	0 432 193 564
Laguna I							
1.9 DTI [B56]	1,9	72	F9Q 710; F9Q 717	04.99-02.01	BO	4	0 432 193 610 <sup>1</sup>
			F9Q 716	10.97-09.99		4	0 432 193 611
						4	0 432 193 753
						4	0 432 193 754 <sup>1</sup>
2.2 D [B56]	2,2	61-63	G8T 706; G8T 752; G8T 790; G8T 792; G8T 794	01.94-02.01		4	0 432 217 263 0 986 430 267
			D Turbo [B56]	02.96-02.01		4	0 432 217 285
						4	0 432 217 285
Laguna I Grandtour							
1.9 DTI [K56]	1,9	72	F9Q 710; F9Q 717	04.99-02.01	BO	4	0 432 193 610 <sup>1</sup>
			F9Q 716	10.97-09.99		4	0 432 193 611
						4	0 432 193 753
						4	0 432 193 754 <sup>1</sup>
			DTI [S56]	03.98-02.01		4	0 432 193 753
						4	0 432 193 754 <sup>1</sup>
2.2 D, D Turbo [K56]	2,2	61-63/ 83-85	G8T 706; G8T 752; G8T 760; G8T 790; G8T 792; G8T 794	02.95-02.01		4	0 432 217 263 0 986 430 267
			D, D Turbo [S56]	02.95-02.01		4	0 432 217 263 0 986 430 267
Megane							
1.9 D	1,9	68	F9QT	06.99→		4	0 432 193 611
Megane I							
1.9 D [X64]	1,9	47-48	F8Q 620; F8Q 624	01.96-02.99	BO	4	0 432 217 292
			DTI [X64]	01.01-10.02		4	0 432 193 563 <sup>1</sup>
						4	0 432 193 564
		69	F9Q 730	06.97-02.99		4	0 432 193 753
						4	0 432 193 754 <sup>1</sup>
		72	F9Q 731	03.99-10.02	BO	4	0 432 193 610 <sup>1</sup>
						4	0 432 193 611
			F9Q 734	06.97-02.99		4	0 432 193 753
						4	0 432 193 754 <sup>1</sup>
			F9Q 736	03.99-10.02	BO	4	0 432 193 610 <sup>1</sup>
						4	0 432 193 611
Megane I Classic							
1.9 D [X64]	1,9	47-48	F8Q 620; F8Q 624	09.96-09.03		4	0 432 217 292
			DTI [X64]	11.00-09.03		4	0 432 193 563 <sup>1</sup>
						4	0 432 193 564
		72	F9Q 730; F9Q 734	08.97-09.03		4	0 432 193 753
						4	0 432 193 754 <sup>1</sup>
			F9Q 731	04.99-09.03	BO	4	0 432 193 610 <sup>1</sup>
						4	0 432 193 611
			F9Q 736	04.99-09.03	BO	4	0 432 193 610 <sup>1</sup>
						4	0 432 193 611
Megane I Coupé							
1.9 DTI [X64]	1,9	72	F9Q 731	03.99-10.02	BO	4	0 432 193 610 <sup>1</sup>
						4	0 432 193 611
			F9Q 734	06.97-02.99		4	0 432 193 753
						4	0 432 193 754 <sup>1</sup>
			F9Q 736	03.99-10.02	BO	4	0 432 193 610 <sup>1</sup>
						4	0 432 193 611





<b>Megane I Grandtour</b>							
1.9 D [X64]	1,9	59	F9Q 744		01.01-09.03	4	0 432 193 563 <sup>1</sup>
						4	0 432 193 564
DTI [X64]	1,9	72	F9Q 731; F9Q 736		07.98-09.03 BO	4	0 432 193 610 <sup>1</sup>
						4	0 432 193 611
<b>Safrane</b>							
2.1 D Turbo [B54]	2,1	65-66	J8S 760		04.92-09.96	4	0 432 217 237 0 986 430 270
2.2 12V D Turbo [B54]	2,2	83	G8T 740		10.96-12.00 BO	4	0 432 217 285
2.5 D Turbo [B54]	2,5	83-85	S8U 762,763 <8144 97 ..>		04.92-09.96	4	0 432 217 247
<b>Scenic I</b>							
1.9 DTI [JA.]	1,9	59	F9Q 744		11.00-04.03	4	0 432 193 563 <sup>1</sup>
						4	0 432 193 564
		72	F9Q 731		03.99-04.03	4	0 432 193 610 <sup>1</sup>
						4	0 432 193 611
			F9Q 734		06.97-02.99	4	0 432 193 753
						4	0 432 193 754 <sup>1</sup>
			F9Q 736		03.99-04.03	4	0 432 193 610 <sup>1</sup>
						4	0 432 193 611
<b>5</b>							
1.6 D	1,6	40	F8M 720; F8M 730		10.84-12.96 BO	4	0 432 217 099
<b>9</b>							
1.6 D [L42]	1,6	40	F8M 700,720; F8M 730		09.82-03.91 BO	4	0 432 217 099
<b>11</b>							
1.6 D	1,6	40	F8M 700; F8M 720; F8M 730		03.83-03.91 BO	4	0 432 217 099
<b>18 Berline</b>							
2.1 D	2,1	48-49	852 710, J8S		05.84-02.86	4	0 432 297 051
D Turbo	2,1	65	J8S 712		04.84-02.86	4	0 432 297 049
<b>18 Break</b>							
2.1 D, D 4x2	2,1	48-49	852 710, J8S		05.84-02.86	4	0 432 297 051
D Turbo	2,1	65	J8S 712		04.84-02.86	4	0 432 297 049
<b>19</b>							
1.9 D [X53]	1,9	47	F8Q 706		09.88-12.01 BO	4	0 432 217 227
					05.92-12.01 BO	4	0 432 217 258
			F8Q 742		06.90-12.01 BO	4	0 432 217 226
<b>19 Sedan</b>							
1.9 D	1,9	48	F8Q-756		01.94-11.01	4	0 430 211 052
<b>21</b>							
1.9 D	1,9	47	F8Q 706		01.93-12.00	4	0 432 217 250
2.1 D [L48]	2,1	46-54	J8S 704		03.86-03.92 BO	4	0 432 297 051
		46-56	J8S 600; J8S 784		04.92-12.94	4	0 432 217 259
		53	J8S 740		05.89-03.93	4	0 432 217 191
D Turbo [L48]	2,1	65	J8S 714; J8S 742; J8S 746		03.86-03.93	4	0 432 297 050
			J8S 788		06.90-03.92	4	0 432 297 050
		65-68	J8S 604; J8S 786		06.91-12.94	4	0 432 217 237 0 986 430 270
<b>21 Fastback</b>							
2.1 D [B48]	2,1	51-54	J8S 600; J8S 784		04.92-12.93	4	0 432 217 259
		53	J8S 740		09.89-12.93	4	0 432 217 191
		54	J8S 704		09.89-03.92 BO	4	0 432 297 051
D Turbo [B48]	2,1	65	J8S 604; J8S 786		06.91-12.93	4	0 432 217 237 0 986 430 270
			J8S 742; J8S 746,714		09.89-03.92	4	0 432 297 050
			J8S 788,714		06.90-03.92	4	0 432 297 050
<b>21 Nevada</b>							
2.1 D [K48]	2,1	49	J8S 704		10.86-12.95 BO	4	0 432 297 051
		51-54	J8S 600; J8S 784		04.92-12.95	4	0 432 217 259
		53-54	J8S 740		05.89-12.95	4	0 432 217 191
D Turbo [K48]	2,1	65	J8S 604; J8S 786		06.91-12.95	4	0 432 217 237 0 986 430 270
			J8S 714		10.86-06.89	4	0 432 297 050
			J8S 742; J8S 746; J8S 788		05.89-12.95	4	0 432 297 050
<b>25</b>							
2.1 D	2,1	46	J8S 706		01.84-04.88	4	0 432 297 051
		50-51	J8S 736		04.88-12.92	4	0 432 217 191
D Turbo	2,1	63	J8S 708		01.84-12.92	4	0 432 297 050
			J8S 738		06.89-12.92	4	0 432 297 050





**ROVER**

<b>Maestro</b>									
2.0 D Turbo	2,0	60	Prima-80T	09.90-12.93	BO	4	<b>0 432 193 866</b>		
<b>Maestro Estate</b>									
2.0 D Turbo	2,0	60	Prima-80T	09.90-12.93	BO	4	<b>0 432 193 866</b>		
<b>Montego</b>									
2.0 D Turbo, D Turbo Estate	2,0	60	Prima-80T	09.90-12.93	BO	4	<b>0 432 193 866</b>		
<b>Serie 200</b>									
220 SD	2,0	63	20 T2R <TCie-M>						
			Fg.Nr. YD 471565→	09.95-03.00		4	<b>0 432 193 571<sup>1</sup></b>		
						4	<b>0 432 193 601</b>		
			Fg.Nr. →YD 471564	09.95-03.00		4	<b>0 432 193 819</b>		
						4	<b>0 432 193 820<sup>1</sup></b>		
SDI	2,0	77	20 T2N <TCie>						
			Fg.Nr. YD 471565→	09.95-03.00		4	<b>0 432 193 571<sup>1</sup></b>		
						4	<b>0 432 193 601</b>		
			Fg.Nr. →YD 471564	09.95-03.00		4	<b>0 432 193 819</b>		
						4	<b>0 432 193 820<sup>1</sup></b>		
<b>Serie 400</b>									
418 TD	1,8	65	XUD7TE	09.91-02.96	BO	4	<b>0 432 217 200</b>		
420 SD	2,0	63	20 T2R <Serie-L>						
			Fg.Nr. YD 471064→	10.95-03.00		4	<b>0 432 193 571<sup>1</sup></b>		
						4	<b>0 432 193 601</b>		
			Fg.Nr. →YD 471063	10.95-03.00		4	<b>0 432 193 819</b>		
						4	<b>0 432 193 820<sup>1</sup></b>		
SDI	2,0	77	20 T2N <Serie-L>						
			Fg.Nr. YD 471064→	10.95-03.00		4	<b>0 432 193 571<sup>1</sup></b>		
						4	<b>0 432 193 601</b>		
			Fg.Nr. →YD 471063	10.95-03.00		4	<b>0 432 193 819</b>		
						4	<b>0 432 193 820<sup>1</sup></b>		
<b>Serie 400 Tourer</b>									
418 TD	1,8	65	XUD7TE	02.96-03.00	BO	4	<b>0 432 217 200</b>		
<b>Serie 600</b>									
620 SDi	2,0	77	20 T2N <SERIE-L>	03.95-12.98		4	<b>0 432 193 819</b>		
						4	<b>0 432 193 820<sup>1</sup></b>		
<b>Serie 800</b>									
825 TD	2,5	87/88	VM-425-SLIER; VM-425-SLIRR	10.91-12.98		4	<b>0 432 217 222 0 986 430 249</b>		
		92	VM-425-CLIER	01.96-12.98		4	<b>0 432 217 222 0 986 430 249</b>		
						4	<b>0 432 217 249<sup>1</sup></b>		
<b>25</b>									
2.0 iDT	2,0	74/83	20 T2N <L-Serie>	02.00-05.05		4	<b>0 432 193 571<sup>1</sup></b>		
						4	<b>0 432 193 601</b>		
<b>45</b>									
2.0 iDT	2,0	74/83	20 T2N <L-Serie>	02.00-05.05		4	<b>0 432 193 571<sup>1</sup></b>		
						4	<b>0 432 193 601</b>		
<b>2000-3500</b>									
2400 D Turbo	2,4	67	VM-HR 492 HT	11.83-10.86		4	<b>0 432 297 047</b>		

**SAAB (SAAB AUTOMOBILE AB)**

<b>9-3</b>									
2.2 TiD [9440]	2,2	95	D223L	10.02-08.04		4	<b>0 432 193 569</b>		
16V D Turbo [9400]	2,2	85/92	D223L <X 22 DTH>; D223L <Y 22 DTH>	03.98-09.02		4	<b>0 432 193 569</b>		
<b>9-3 Coupé</b>									
2.2 16V D Turbo [9400]	2,2	92	D223L <Y 22 DTH>	11.00-09.02		4	<b>0 432 193 569</b>		
<b>9-5</b>									
2.2 TiD [9600]	2,2	88	D223L	03.02-08.05		4	<b>0 432 193 570</b>		
<b>9-5 Kombi</b>									
2.2 TiD [9600]	2,2	88	D223L	03.02-08.05		4	<b>0 432 193 570</b>		







SEAT

**Alhambra**

1.9 TDI [7V8]	1,9	66	AHU; 1Z	03.96-02.00	4	0 432 193 829 <sup>1</sup>	
						4	0 432 193 838
		81	AFN; AVG	05.97-02.00	4	0 432 193 744 <sup>1</sup>	
					4	0 432 193 746	

**Arosa**

1.7 SDI [6H1]	1,7	44	AKU	08.97-10.03	4	0 432 193 680 <sup>1</sup>	
					4	0 432 193 682	

**Cordoba**

1.9 D [6K2]	1,9	47-50	1Y	09.93-12.02	4	0 432 217 240	0 986 430 187	
		48	AGP	01.00→	4	0 432 217 240	0 986 430 187	
SDI [6K2]	1,9	47	AEY	12.95-12.02	4	0 432 193 794		
					4	0 432 193 795 <sup>1</sup>		
		50	AGP	05.99-08.02	4	0 432 193 597 <sup>1</sup>		
					4	0 432 193 599		
SDI [6L2]	1,9	47	ASY	09.02-12.05	4	0 432 193 573 <sup>1</sup>		
					4	0 432 193 599		
TD [6K2]	1,9	55	AAZ	09.93-08.97	4	0 432 217 284	0 986 430 206	
TDI [6K2]	1,9	66	AGR	05.99-12.02	4	0 432 193 732		
					4	0 432 193 734 <sup>1</sup>		
				05.99→	4	0 432 193 732		
					4	0 432 193 734 <sup>1</sup>		
				01.00→	4	0 432 193 829 <sup>1</sup>		
					4	0 432 193 838		
				AHU; 1Z	07.96-12.02	4	0 432 193 829 <sup>1</sup>	
					4	0 432 193 838		
				ALH	05.99-05.01	4	0 432 193 695	
				81	AFN	03.97-12.02	4	0 432 193 744 <sup>1</sup>
	4	0 432 193 746						
		ASV	05.99-12.02	4	0 432 193 594			

**Cordoba Vario**

1.9 SDI [6K5]	1,9	47	AEY	06.97-06.99	4	0 432 193 794			
					4	0 432 193 795 <sup>1</sup>			
		50	AGP; AQM	05.99-08.02	4	0 432 193 597 <sup>1</sup>			
					4	0 432 193 599			
TDI [6K5]	1,9	66	AGR	05.99-07.99	4	0 432 193 702			
					4	0 432 193 704 <sup>1</sup>			
				08.99-08.02	4	0 432 193 732			
					4	0 432 193 734 <sup>1</sup>			
				AHU	06.97-06.99	4	0 432 193 829 <sup>1</sup>		
					4	0 432 193 838			
				ALH	05.99-07.99	4	0 432 193 702		
					4	0 432 193 704 <sup>1</sup>			
				81	AFN	08.99-05.01	4	0 432 193 695	
					4	0 432 193 744 <sup>1</sup>			
		ASV	02.98-06.99	4	0 432 193 746				
			05.99-08.02	4	0 432 193 594				

**Ibiza**

1.7 D [Y..]	1,7	40	138 A 5..	06.84-05.93	4	0 432 297 042			
1.9 D [6K1]	1,9	47-50	1Y	03.93-10.99	4	0 432 217 240	0 986 430 187		
SDI [6K1]	1,9	47	AEY	12.95-10.99	4	0 432 193 794			
					4	0 432 193 795 <sup>1</sup>			
				50	AGP	05.99-05.02	4	0 432 193 597 <sup>1</sup>	
					4	0 432 193 599			
			AQM	05.99-05.02	4	0 432 193 597 <sup>1</sup>			
					4	0 432 193 599			
SDI [6L1]	1,9	47	ASY	01.02-12.05	4	0 432 193 599			
					4	0 432 193 597 <sup>1</sup>			
					4	0 432 193 573 <sup>1</sup>			
TD [6K1]	1,9	55	AAZ	03.93-08.97	4	0 432 217 284	0 986 430 206		





◀ SEAT

1.9 TDI [6K1]	1,9	66	AGR	05.99-05.02	4	0 432 193 732	
					4	0 432 193 734 <sup>1</sup>	
			AHU; 1Z	07.96-06.99	4	0 432 193 829 <sup>1</sup>	
					4	0 432 193 838	
			ALH	05.99-05.02	4	0 432 193 695	
			81 AFN	03.97-06.99	4	0 432 193 744 <sup>1</sup>	
		4	0 432 193 746				
			ASV	05.99-05.02	4	0 432 193 594	

<b>Inca</b>									
1.9 D	1,9	47	AEY	05.99→	4	0 432 217 240	0 986 430 187		
			D [6K9]	1Y	11.95-06.03	4	0 432 217 240	0 986 430 187	
			SDI [6K9]	AYQ					
				Mot.Nr. →061 300	09.00-06.03	4	0 432 193 680 <sup>1</sup>		
				Mot.Nr. 061 301→	09.00-06.03	4	0 432 193 544 <sup>1</sup>		
			4	0 432 193 682					

<b>Leon</b>								
1.9 SDI [1M1]	1,9	50	AQM					
				Mot.Nr. →152 596	12.99-10.03	4	0 432 193 597 <sup>1</sup>	
						4	0 432 193 599	
				Mot.Nr. 152 597→	12.99-10.03	4	0 432 193 575 <sup>1</sup>	
						4	0 432 193 599	
TDI [1M1]	1,9	66	AGR	12.99-09.02	4	0 432 193 732		
					4	0 432 193 734 <sup>1</sup>		
			ALH	03.99-07.04	4	0 432 193 695		
				Fg.Nr. →1M..2R120 000	03.99-04.02	4	0 432 193 693 <sup>1</sup>	
				Fg.Nr. 1M..2R120 001→	05.02-07.04	4	0 432 193 579 <sup>1</sup>	
			81 AHF	10.98-09.02	4	0 432 193 744 <sup>1</sup>		
					4	0 432 193 746		
				ASV	10.99-10.05	4	0 432 193 594	
				Mot.Nr. →402 738	10.99-10.05	4	0 432 193 592 <sup>1</sup>	
				Mot.Nr. 402 739→	10.99-10.05	4	0 432 193 575 <sup>1</sup>	

<b>Malaga</b>							
1.7 D	1,7	40	138 A 5..	05.85-12.93	4	0 432 297 042	

<b>Ronda</b>							
1.7 D	1,7	40	138 A 5..	06.82-12.86	4	0 432 297 042	

<b>Terra</b>							
1.4 D	1,4	35		10.90-12.94	4	0 432 217 208	

<b>Toledo</b>											
1.9 D [1L2]	1,9	47	1Y	05.91-03.99	4	0 432 217 210					
			TD [1L2]	AAZ	05.91-04.97	4	0 432 217 232				
			TDI [1L2]	66	AHU; 1Z	04.95-03.99	4	0 432 193 829 <sup>1</sup>			
							4	0 432 193 838			
					81 AFN	11.96-03.99	4	0 432 193 744 <sup>1</sup>			
					4	0 432 193 746					
			TDI [1M2]	1,9	66	AGR	04.99-09.02	4	0 432 193 732		
								4	0 432 193 734 <sup>1</sup>		
						ALH	04.99-07.04	4	0 432 193 695		
							Fg.Nr. →1M..2..R120 000	04.99-04.02	4	0 432 193 693 <sup>1</sup>	
							Fg.Nr. 1M..2..R120 001→	05.02-07.04	4	0 432 193 680 <sup>1</sup>	
						81 AHF	04.99-09.02	4	0 432 193 744 <sup>1</sup>		
								4	0 432 193 746		
							ASV	05.99-12.03	4	0 432 193 594	
							Mot.Nr. →402 738	05.99-12.03	4	0 432 193 592 <sup>1</sup>	
	Mot.Nr. 402 739→	05.99-12.03				4	0 432 193 575 <sup>1</sup>				





l/ccm



kW/(PS)



Typ



Zyl.



SKODA

Fabia									
1.9 SDI [6Y3]	1,9	47	ASY		09.99-12.07		4	0 432 193 599	
				Fg.Nr. →6Y..2..592 833 →6Y..2X043 509	09.99-06.02		4	0 432 193 597 <sup>1</sup>	
				Fg.Nr. 6Y..2..592 834 → 6Y..2X043 510→	07.02-12.07		4	0 432 193 573 <sup>1</sup>	
Fabia Combi									
1.9 SDI [6Y5]	1,9	47	ASY		08.00-12.07		4	0 432 193 599	
				Fg.Nr. →6Y..2..592 833 →6Y..2X043 509	08.00-06.02		4	0 432 193 597 <sup>1</sup>	
				Fg.Nr. 6Y..2..592 834 → 6Y..2X043 510→	07.02-12.07		4	0 432 193 573 <sup>1</sup>	
Fabia Schrägheck									
1.9 SDI [6Y2]	1,9	47	ASY		09.99-03.08		4	0 432 193 599	
				Fg.Nr. →6Y..2..592 833 →6Y..2X043 509	09.99-06.02		4	0 432 193 597 <sup>1</sup>	
				Fg.Nr. 6Y..2..592 834 → 6Y..2X043 510→	07.02-03.08		4	0 432 193 573 <sup>1</sup>	
Felicia									
1.9 D [6U1]	1,9	47	AEF		10.95-08.01		4	0 432 217 240 0 986 430 187	
Felicia Combi									
1.9 D [6U5]	1,9	47	AEF		10.95-08.01		4	0 432 217 240 0 986 430 187	
Felicia Fun									
1.9 D [6UF]	1,9	47	AEF		08.96-03.01		4	0 432 217 240 0 986 430 187	
Octavia									
1.9 SDI [1U2]	1,9	50	AQM		08.00-12.03		4	0 432 193 599	
				Fg.Nr. →1U..3.666 021 →1U..38665 263	08.00-04.02		4	0 432 193 597 <sup>1</sup>	
				Fg.Nr. 1U..3.666 022 → 1U..38665 264→	05.02-12.03		4	0 432 193 573 <sup>1</sup>	
SDI, TDI [1U2]	1,9	50/66	AGP; AGR		09.96-12.09		4	0 432 193 732	
							4	0 432 193 734 <sup>1</sup>	
TDI [1U2]	1,9	66	ALH		08.00-03.10	AG	4	0 432 193 702	
						GS	4	0 432 193 695	
				Fg.Nr. →1U..3.666 021 →1U..38665 263	08.00-04.02	AG	4	0 432 193 704 <sup>1</sup>	
						GS	4	0 432 193 693 <sup>1</sup>	
				Fg.Nr. 1U..3.666 022 → 1U..38665 264→	05.02-03.10	AG	4	0 432 193 584 <sup>1</sup>	
						GS	4	0 432 193 579 <sup>1</sup>	
		81	AHF		05.97-01.06		4	0 432 193 744 <sup>1</sup>	
							4	0 432 193 746	
			ASV		08.00-01.06		4	0 432 193 594	
				Fg.Nr. →1U..3.666 021 →1U..38665 263	08.00-04.02		4	0 432 193 592 <sup>1</sup>	
				Fg.Nr. 1U..3.666 022 → 1U..38665 264→	05.02-01.06		4	0 432 193 542 <sup>1</sup>	
Octavia Combi									
1.9 SDI [1U5]	1,9	50	AGP		05.97-07.00		4	0 432 193 732	
							4	0 432 193 734 <sup>1</sup>	
			AQM		08.00-12.03		4	0 432 193 599	
				Fg.Nr. →1U..3.666 021 →1U..38665 263	08.00-04.02		4	0 432 193 597 <sup>1</sup>	
				Fg.Nr. 1U..3.666 022 → 1U..38665 264→	05.02-12.03		4	0 432 193 573 <sup>1</sup>	
TDI [1U5]	1,9	66	ALH		08.00-03.10	AG	4	0 432 193 702	
						GS	4	0 432 193 695	
				Fg.Nr. →1U..3.666 021 →1U..38665 263	08.00-04.02	AG	4	0 432 193 704 <sup>1</sup>	
						GS	4	0 432 193 693 <sup>1</sup>	
				Fg.Nr. 1U..3.666 022 → 1U..38665 264→	05.02-03.10	AG	4	0 432 193 584 <sup>1</sup>	
						GS	4	0 432 193 579 <sup>1</sup>	
		81	AHF		08.97-01.06		4	0 432 193 744 <sup>1</sup>	
							4	0 432 193 746	
			ASV		08.00-01.06		4	0 432 193 594	
				Fg.Nr. →1U..3.666 021 →1U..38665 263	08.00-04.02		4	0 432 193 592 <sup>1</sup>	
				Fg.Nr. 1U..3.666 022 → 1U..38665 264→	05.02-01.06		4	0 432 193 542 <sup>1</sup>	
TDI, TDI 4x4 [1U5]	1,9	66	AGR		05.98-12.09		4	0 432 193 732	
							4	0 432 193 734 <sup>1</sup>	
Pick-Up									
1.9 D [6U7]	1,9	47	AEF		01.96-03.01		4	0 432 217 240 0 986 430 187	
Superb									
2.5 TDI [3U4]	2,5	114	AYM		12.01-08.03		6	0 432 133 792 <sup>1</sup>	
							6	0 432 133 794	
		120	BDG		06.03-03.08		6	0 432 133 783 <sup>1</sup>	
							6	0 432 133 785	





**SSANGYONG**

<b>Korando</b>							
2.3 D [KJ]	2,3	58-59	OM661 D23 <OM 601.990>	07.96-12.05	4	<b>0 432 217 157</b>	<b>0 986 430 197</b>
D [K4]	2,3	58-59	OM661 D23 <OM 601.990>	10.86-06.96	4	<b>0 432 217 157</b>	<b>0 986 430 197</b>
<b>2.9 D [KJ]</b>							
TD Intercooler [KJ]	2,9	70-73	OM662 D29 <OM 602.910>	07.96-12.05	5	<b>0 432 217 157</b>	<b>0 986 430 197</b>
	2,9	88-97	OM 662 LA <OM 602>	07.96-11.98	5	<b>0 432 217 169</b>	<b>0 986 430 173</b>
<b>Musso</b>							
2.3 D [MJ]	2,3	57-58	OM661 D23 <OM 601.910>	07.93-12.05	4	<b>0 432 217 157</b>	<b>0 986 430 197</b>
<b>2.9 D [MJ]</b>							
	2,9	70-73	OM 662 D29 <OM 602.910>	07.93-12.05	5	<b>0 432 217 157</b>	<b>0 986 430 197</b>
		88	OM 662	07.93-11.94	5	<b>0 432 217 157</b>	<b>0 986 430 197</b>
				12.94-04.05	5	<b>0 430 211 066</b>	
TD Intercooler [MJ]	2,9	88	OM 662 D29 LA <OM 602.910>	05.97-12.05	5	<b>0 432 217 169</b>	<b>0 986 430 173</b>

**STEYR (STEYR-DAIMLER-PUCH AG)**

<b>G</b>							
300 DT	3,0	130	OM 606.964	01.98→	6	<b>0 432 217 280</b>	<b>0 986 430 388</b>

**TALBOT**

<b>Horizon</b>							
1.9 D	1,9	47-48	XUD9	05.85-06.86	BO	4	<b>0 432 217 153</b>

**TATA (TELCO)**

<b>Safari</b>							
2.0 D Turbo	2,0	66	483 DL	02.98→		4	<b>9 430 032 328</b>
D Turbo 4x4	2,0	66	483 DL	08.00→		4	<b>9 430 032 328</b>
<b>Sierra</b>							
1.9 D	1,9	44-50	483 DL	11.89-06.95		4	<b>9 430 032 266</b>
				07.95-06.98		4	<b>9 430 032 280</b>
D Turbo	1,9	66	483 DL TCIC	06.97-05.02		4	<b>9 430 032 328</b>
<b>Sumo</b>							
1.9 D	1,9	50	483 DL	05.94-06.95		4	<b>9 430 032 266</b>
				07.95-07.00		4	<b>9 430 032 280</b>
				08.00→		4	<b>9 430 032 328</b>
D Turbo, D Turbo 4x4	1,9	66	483 DL TCIC	01.98→		4	<b>9 430 032 328</b>
3.0 Spacio	3,0	48	497 SP	01.98-10.04		4	<b>F 002 C8Z 208</b>
<b>Tatamobile</b>							
2.0 D	1,9	44-50	483 DL	11.89-06.95		4	<b>9 430 032 266</b>
				07.95-07.00		4	<b>9 430 032 280</b>
<b>Telcoline</b>							
2.0 TDi	2,0	64		10.03→		4	<b>9 430 032 238</b>
<b>207</b>							
DI 3.0 D	3,0	48	497SP	05.02→		4	<b>F 002 C8Z 208</b>

**UAZ**

<b>Hunter</b>							
2.2 D 4x4	2,2	72	5143.1 <Euro 2>	01.06→		4	<b>0 432 193 549</b>





## VAUXHALL

**Astra**

1.7 D/DR [F]	1,7	42-44	17 D/DR <OHC>	12.91-02.98	4	0 432 217 299	0 986 430 449
DT [G]	1,7	50	X 17 DTL <Turbo>	03.98-08.00	4	0 432 217 299	0 986 430 449
DTL [F]	1,7	50	X 17 DTL <OHC>	07.95-02.98	4	0 432 217 299	0 986 430 449
TD [F]	1,7	60	17 DT/TC4 <EE1 OHC>	12.91-02.98	DKF	4	9 430 610 128 0 986 433 002
2.0 DTI [G]	2,0	74	Y 20 DTH <Turbo>				
			Mot.Nr. →22999999 →25999999 →28999999 →2H999999	09.00-08.05	4	0 432 193 634	
DTL [G]	2,0	60	X 20 DTL <Turbo>	03.98-08.00	EU2,NC8	4	0 432 193 686
					EU3,NT5	4	0 432 193 633
			Y 20 DTL <Turbo>	09.00-08.05		4	0 432 193 633
2.2 DTI [G]	2,2	92	Y 22 DTR <Turbo>	09.01-08.05		4	0 432 193 569

**Astra Estate**

1.7 D/DR [F]	1,7	42-44	17 D/DR <OHC>	12.91-02.98	4	0 432 217 299	0 986 430 449
DT [G]	1,7	50	X 17 DTL <Turbo>	03.98-08.00	4	0 432 217 299	0 986 430 449
DTL [F]	1,7	50	X 17 DTL <OHC>	07.95-02.98	4	0 432 217 299	0 986 430 449
TD [F]	1,7	60	17 DT <TC4EE1>	12.91-02.98	DKF	4	9 430 610 128 0 986 433 002
2.0 DTI [G]	2,0	74	Y 20 DTH <Turbo>				
			Mot.Nr. →22999999 →25999999 →28999999 →2H999999	09.00-08.05	4	0 432 193 634	
DTL [G]	2,0	60	X 20 DTL <Turbo>	03.98-08.00	EU2,NC8	4	0 432 193 686
					EU3,NT5	4	0 432 193 633
			Y 20 DTL <Turbo>	09.00-08.05		4	0 432 193 633

**Astra Van**

1.7 D/DR, DTL [F]	1,7	42-44/50	X 17 DTL <OHC>; 17 D/DR <OHC>	12.91-02.98	4	0 432 217 299	0 986 430 449
DT [G]	1,7	50	X 17 DTL <Turbo>	03.98-08.00	4	0 432 217 299	0 986 430 449
2.0 DTI [G]	2,0	74	Y 20 DTH <Turbo>				
			Mot.Nr. →22999999 →25999999 →28999999 →2H999999	09.00-08.05	4	0 432 193 634	
DTL [G]	2,0	60	X 20 DTL <Turbo>	03.98-08.00	EU2,NC8	4	0 432 193 686
					EU3,NT5	4	0 432 193 633

**Brava Pick-Up**

2.2 D [TFO]	2,2	39	4 FD1	06.89-09.96	DKF	4	9 430 610 031
					DKF,EFV	4	9 430 610 145
2.5 D [TFO]	2,5	56-74	4 JA1	06.90-09.92	DKF	4	9 430 610 086
				10.92-09.96	DKF,EFV	4	9 430 610 138
TD [TFO]	2,5	56	4 JA1 T	10.89-12.96	DKF,EFV	4	9 430 610 155
				07.94-12.96	DKF	4	9 430 610 139
3.1 TD [TFO]	3,1	80	4 JG2 T	03.95-03.96	DKF	4	9 430 610 140
				04.96-12.96	DKF	4	9 430 610 141

**Carlton II**

2.3 D	2,3	52/63	23 D	05.83-08.86		4	0 432 217 126
-------	-----	-------	------	-------------	--	---	---------------

**Carlton III**

2.3 D	2,3	54	23 YD				
			Fg.Nr. K1000099→	09.86-10.94		4	0 432 217 196
			Fg.Nr. →K1000098	09.86-10.94		4	0 432 217 171
TD Interc.	2,3	74	23 DTR				
			Fg.Nr. K1000099→	09.88-10.94		4	0 432 217 196
			Fg.Nr. →K1000098	09.88-10.94		4	0 432 217 133
YTD	2,3	66	23 YDT				
			Fg.Nr. K1000099→	09.86-09.88		4	0 432 217 196
			Fg.Nr. →K1000098	09.86-09.88		4	0 432 217 133

**Cavalier II**

1.6 D	1,6	40	16 D, DA <OHC>	03.82-08.88		4	0 432 217 082
-------	-----	----	----------------	-------------	--	---	---------------

**Cavalier III**

1.7 D	1,7	42	17 D / DR				
			Mot.Nr. →14363650	09.88-11.95	BO	4	0 432 217 197
			Mot.Nr. 14363651→	09.88-11.95	BO	4	0 432 217 246
TD	1,7	60	17 DT/TC4 EE1	09.88-11.95	DKF	4	9 430 610 128 0 986 433 002





◀ VAUXHALL

Combo							
1.7 D	1,7	44	X 17 D 4EE1				
			Mot.Nr. →602344	04.96-10.01	DKF	4	9 430 610 136
			Mot.Nr. 602345→	04.96-10.01	DKF	4	9 430 610 136
			17 D <4EE1>				
			Mot.Nr. →602344	09.94-10.01	DKF	4	9 430 610 136
Corsa							
1.5 D [B]	1,5	37	X 15 D <4EC1 OHC>				
			Mot.Nr. →957024	04.96-08.00	DKF	4	9 430 610 136
			Mot.Nr. 957025→	04.96-08.00	DKF	4	9 430 610 136
			15 D <4EC1>				
			Mot.Nr. →957024	09.94-08.00	DKF	4	9 430 610 136
			Mot.Nr. 957025→	09.94-08.00	DKF	4	9 430 610 136
TD [B]	1,5	49	15 TD <T4EC1 Turbo>				
			Mot.Nr. →957024	09.94-08.00	DKF	4	9 430 610 136
			Mot.Nr. 957025→	09.94-08.00	DKF	4	9 430 610 136
XTD [B]	1,5	49	X 15 TD <4EE1 Turbo>				
			Mot.Nr. →957024	04.96-08.00	DKF	4	9 430 610 136
			Mot.Nr. 957025→	04.96-08.00	DKF	4	9 430 610 136
1.7 D [B]	1,7	44	X 17 D 4EE1				
			Mot.Nr. →602344	04.96-08.00	DKF	4	9 430 610 136
			Mot.Nr. 602345→	04.96-08.00	DKF	4	9 430 610 136
			17 D <4EE1>				
			Mot.Nr. →602344	09.94-08.00	DKF	4	9 430 610 136
Frontera							
2.2 DTI [B]	2,2	85/88	X 22 DTH <Turbo>; Y 22 DTH <Turbo>	09.98-09.04	NC8	4	0 432 193 650
2.3 TD [A]	2,3	74	23 DT <Turbo>	01.92-08.95		4	0 432 217 196
2.5 TDS Turbo [A]	2,5	85	VM41B <Venturi-25TD>	06.96-08.98		4	0 432 217 222 0 986 430 249
						4	0 432 217 249 <sup>1</sup>
2.8 TDI Turbo [A]	2,8	83	4JB1T	02.95-08.98	DKF	4	9 430 610 163
					DKF,EFV	4	9 430 610 163
Monterey							
3.1 TD [A]	3,1	84	4 JG2 TC OHV	CH 09.92-08.93		4	9 430 610 121
				09.91-08.92		4	9 430 610 121
				09.92-08.93	RLE	4	9 430 610 122
				09.93-03.96		4	9 430 610 122
				04.96-08.98		4	9 430 610 141
				CH 09.92-08.93	LLE	4	9 430 610 141
Nova							
1.5 D, TD	1,5	37/49	15 DT/T4EC1-AADT <OHC>; 15 D/4EC1-AAD <OHC>	09.87-03.93	DKF	4	9 430 610 060
				09.87-08.94	DKF	4	9 430 610 045
Omega							
2.0 DTI [B]	2,0	74	X 20 DTH Turbo	09.97-08.00	NT5	4	0 432 193 634
2.2 DTI [B]	2,2	88	Y 22 DTH <Turbo>	06.00-09.03		4	0 432 193 570
2.5 TD [B]	2,5	96	U 25 TD <R6 Turbo>	04.94-07.96		6	0 432 217 223 0 986 430 241
						6	0 432 217 236 <sup>1</sup>
				08.96-02.01		6	0 432 217 278 0 986 430 302
						6	0 432 217 279 <sup>1</sup>
TDI [B]	2,5	96	X 25 TD <Turbo>	04.96-07.96		6	0 432 217 223 0 986 430 241
						6	0 432 217 236 <sup>1</sup>
				08.96-09.04		6	0 432 217 278 0 986 430 302
						6	0 432 217 279 <sup>1</sup>
Signum							
2.0 DTI	2,0	74	Y 20 DTH <Ecotec>	05.03-09.05		4	0 432 193 525
2.2 DTI	2,2	86-92	Y 22 DTR <Ecotec>	05.03-09.08		4	0 432 193 525
Sintra							
2.2 TD	2,2	85	X 22 DTH <Turbo>	09.97-09.99		4	0 432 193 688
Vectra							
1.7 TD [B]	1,7	60	X 17 TD <TC4 EE1 Turbo>	09.95-08.01	DKF	4	9 430 610 128





<b>2.0 DI [B]</b>	2,0	60	X 20 DTL <Ecotec 16V Turbo>				
			Fg.Nr. XL000001→	09.96-08.00	4	<b>0 432 193 686</b>	
			Fg.Nr. X1000001→	09.96-08.00	4	<b>0 432 193 633</b>	
			Mot.Nr. →17062265	09.96-08.00	4	<b>0 432 193 797</b>	
			Mot.Nr. 17062266→ Fgst.Nr.W7999999	09.96-08.00	4	<b>0 432 193 686</b>	
<b>DTI [B]</b>	2,0	74	X 20 DTH <16V Turbo>				
			Fg.Nr. XL000001→	09.97-08.00	4	<b>0 432 193 687</b>	
			Fg.Nr. X1000001→ XL000001→	09.97-08.00	4	<b>0 432 193 634</b>	
			Mot.Nr. 17062266→ Fgst.Nr.W7999999	09.97-08.00	4	<b>0 432 193 687</b>	
			Y 20 DTH <16V Turbo>				
			Fg.Nr. XL000001→	09.00-08.01	4	<b>0 432 193 686</b>	
			Fg.Nr. X1000001→	09.00-08.01	4	<b>0 432 193 633</b>	
			Mot.Nr. →17062265	09.00-08.01	4	<b>0 432 193 797</b>	
			Mot.Nr. 17062266→ Fgst.Nr.W7999999	09.00-08.01	4	<b>0 432 193 686</b>	
<b>DTI [C]</b>	2,0	74	Y 20 DTH <Turbo Ecotec>	04.02-09.05	4	<b>0 432 193 525</b>	
<b>2.2 DTI [B]</b>	2,2	92	Y 22 DTR <Turbo>	09.00-08.01	4	<b>0 432 193 569</b>	
<b>DTI [C]</b>	2,2	86-92	Y 22 DTR <Turbo Ecotec>	04.02-09.05	4	<b>0 432 193 569</b>	
<b>Vectra Estate</b>							
<b>1.7 TD [B]</b>	1,7	60	X 17 TD <TC4 EE1 Turbo>	09.95-08.01	DKF	4	<b>9 430 610 128</b>
<b>2.0 DI [B]</b>	2,0	60	X 20 DTL <Ecotec 16V Turbo>				
			Fg.Nr. X1000001→	09.96-08.00	4	<b>0 432 193 633</b>	
			Mot.Nr. →17062265	09.96-08.00	4	<b>0 432 193 797</b>	
			Mot.Nr. 17062266→ Fgst.Nr.W7999999	09.96-08.00	4	<b>0 432 193 686</b>	
			Fg.Nr. XL000001→				
<b>DTI [B]</b>	2,0	74	X 20 DTH <16V Turbo>				
			Fg.Nr. X1000001→ XL000001→	09.97-08.00	4	<b>0 432 193 634</b>	
			Mot.Nr. 17062266→ Fgst.Nr.W7999999	09.97-08.00	4	<b>0 432 193 687</b>	
			Fg.Nr. XL000001→				
			Y 20 DTH <16V Turbo>				
			Fg.Nr. X1000001→	09.00-08.01	4	<b>0 432 193 633</b>	
			Mot.Nr. →17062265	09.00-08.01	4	<b>0 432 193 797</b>	
			Mot.Nr. 17062266→ Fgst.Nr.W7999999	09.00-08.01	4	<b>0 432 193 686</b>	
			Fg.Nr. XL000001→				
<b>DTI [C]</b>	2,0	74	Y 20 DTH <Turbo Ecotec>	09.03-09.05	4	<b>0 432 193 525</b>	
<b>2.2 DTI [B]</b>	2,2	92	Y 22 DTR <Turbo>	09.00-08.01	4	<b>0 432 193 569</b>	
<b>DTI [C]</b>	2,2	86-92	Y 22 DTR <Ecotec>	09.03-09.05	4	<b>0 432 193 569</b>	
<b>Zafira</b>							
<b>2.0 DI [A]</b>	2,0	60	X 20 DTL <Turbo Ecotec>	03.99-08.00	EU2,NC8	4	<b>0 432 193 686</b>
					EU3,NT5	4	<b>0 432 193 633</b>
<b>DTI [A]</b>	2,0	74	Y 20 DTH <Turbo Ecotec>				
			Mot.Nr. →22999999→25999999	04.99-06.05	4	<b>0 432 193 634</b>	
			→28999999→2H999999				
			Mot.Nr. 32000001→35000001→	04.99-06.05	4	<b>0 432 193 525</b>	
			38000001→3H000001→				
<b>2.2 DTI [A]</b>	2,2	92	Y 22 DTR <Turbo Ecotec>	03.02-06.05	4	<b>0 432 193 569</b>	
<b>VOLVO</b>							
<b>S40 I</b>							
<b>1.9 D</b>	1,9	70	D4192T2	03.98-07.00	4	<b>0 432 193 753</b>	
					4	<b>0 432 193 754<sup>1</sup></b>	
<b>S70</b>							
<b>2.5 TDI</b>	2,5	103	D5252 T				
			Fg.Nr. →598544FC1→596595FC2	01.97-07.00	5	<b>0 432 193 771<sup>1</sup></b>	
					5	<b>0 432 193 786</b>	
			Fg.Nr. 598545FC1→596596FC2→	01.97-07.00	5	<b>0 432 193 613<sup>1</sup></b>	
					5	<b>0 432 193 615</b>	
<b>S80 I</b>							
<b>2.5 TDI</b>	2,5	103	D5252T	08.98-07.01	5	<b>0 432 193 613<sup>1</sup></b>	
					5	<b>0 432 193 615</b>	





◀ VOLVO

V40							
1.9 D	1,9	70	D4192T2		08.98-07.00	4	0 432 193 753
						4	0 432 193 754 <sup>1</sup>
V70 I							
2.5 TDI	2,5	103	D5252T				
			Fg.Nr. →587536		01.97-03.00	5	0 432 193 771 <sup>1</sup>
						5	0 432 193 786
			Fg.Nr. 587537→		01.97-03.00	5	0 432 193 613 <sup>1</sup>
						5	0 432 193 615
V70 II							
2.5 D	2,5	103	D5252T		03.00-07.01	5	0 432 193 613 <sup>1</sup>
						5	0 432 193 615
240							
2.4 D	2,4	58-60	D24		04.79-07.93 GS	6	0 432 217 086
740							
2.4 D	2,4	60	D24		04.84-07.92 GS	6	0 432 217 086
850							
TDI	2,5	103	D5252T		05.96-07.97	5	0 432 193 771 <sup>1</sup>
						5	0 432 193 786
850 Kombi							
TDI	2,5	103	D5252T		05.96-07.97	5	0 432 193 771 <sup>1</sup>
						5	0 432 193 786
940							
2.4 D	2,4	60	D24		09.90-07.93 GS	4	0 432 217 086

**VW (VOLKSWAGEN)**

Bora							
1.9 SDI [1J2]	1,9	50	AGP		09.98-04.01	4	0 432 193 732
						4	0 432 193 734 <sup>1</sup>
			AQM		09.98-05.05	4	0 432 193 599
			Fg.Nr. →1J..2..900 000		09.98-04.02	4	0 432 193 597 <sup>1</sup>
			Fg.Nr. 1J..3..000 001→		05.02-05.05	4	0 432 193 573 <sup>1</sup>
TDI [1J2]	1,9	66	ALH		09.98-05.05	4	0 432 193 702
					GS	4	0 432 193 695
			Fg.Nr. →1J..2..900 000		09.98-04.02	4	0 432 193 704 <sup>1</sup>
					GS	4	0 432 193 693 <sup>1</sup>
			Fg.Nr. 1J..3..000 001→		05.02-05.05	4	0 432 193 584 <sup>1</sup>
					GS	4	0 432 193 744 <sup>1</sup>
		81	AHF		09.98-05.05	4	0 432 193 746
			Fg.Nr. →1J..2..900 000		09.98-04.02	4	0 432 193 744 <sup>1</sup>
			Fg.Nr. 1J..3..000 001→		05.02-05.05	4	0 432 193 577 <sup>1</sup>
			ASV		05.00-05.05	4	0 432 193 594
			Fg.Nr. →1J..2..900 000		05.00-04.02	4	0 432 193 592 <sup>1</sup>
			Fg.Nr. 1J..3..000 001→		05.02-05.05	4	0 432 193 542 <sup>1</sup>
TDI [9M2]	1,9	74	BEW		01.05-09.05	4	0 432 193 777
TDI, TDI 4 Motion [1J2]	1,9	66	AGR		09.98-05.05	4	0 432 193 732
			Fg.Nr. →1J..2..900 000		09.98-04.02	4	0 432 193 734 <sup>1</sup>
			Fg.Nr. 1J..3..000 001→		05.02-05.05	4	0 432 193 575 <sup>1</sup>
Bora Variant							
1.9 TDI [1J6]	1,9	66	AGR		09.98-05.05	4	0 432 193 732
			Fg.Nr. →1J..2..900 000		09.98-04.02	4	0 432 193 734 <sup>1</sup>
			Fg.Nr. 1J..3..000 001→		05.02-05.05	4	0 432 193 575 <sup>1</sup>
		81	AHF		05.99-05.05	4	0 432 193 746
			Fg.Nr. →1J..2..900 000		05.99-04.02	4	0 432 193 744 <sup>1</sup>
			Fg.Nr. 1J..3..000 001→		05.02-05.05	4	0 432 193 577 <sup>1</sup>
			ASV		05.00-05.05	4	0 432 193 594
			Fg.Nr. →1J..2..900 000		05.00-04.02	4	0 432 193 592 <sup>1</sup>
			Fg.Nr. 1J..3..000 001→		05.02-05.05	4	0 432 193 542 <sup>1</sup>







<b>Caddy</b>									
1.7 SDI [9K9]	1,7	42	AHB		07.96-09.00	4	0 432 193 707 <sup>1</sup>		
						4	0 432 193 709		
1.9 D [9K9]	1,9	47	1Y		11.95-06.03	4	0 432 217 240	0 986 430 187	
SDI [9K9]	1,9	47	AEY		11.95-09.00	4	0 432 193 794		
						4	0 432 193 795 <sup>1</sup>		
			AYQ		09.00-06.03	4	0 432 193 680 <sup>1</sup>		
						4	0 432 193 682		
TDI [9K9]	1,9	66	AHU; 1Z		10.96-09.00	4	0 432 193 829 <sup>1</sup>		
						4	0 432 193 838		
			ALE		09.97-09.00	4	0 432 193 693 <sup>1</sup>		
						4	0 432 193 695		
			ALH		09.00-06.03	4	0 432 193 693 <sup>1</sup>		
						4	0 432 193 695		
<b>Caddy Pickup</b>									
1.6 D [14, 1A]	1,6	40	JK		D 08.85-07.90 AGF	4	0 432 217 164		
					08.82-07.90	4	0 432 217 084	0 986 430 081	
			ME		08.90-07.92	4	0 432 217 164		
1.9 D [9U7]	1,9	47	AEF		06.96-12.00	4	0 432 217 240	0 986 430 187	
<b>Golf</b>									
1.6 D [1G1]	1,6	40	ME		12.88-12.91	4	0 432 217 164		
D [19]	1,6	38	ME		09.85-07.88	4	0 432 217 164		
<b>Golf I Bakkie</b>									
1.6 D [15, 16]	1,6	40	JK		06.81-12.87	4	0 432 217 084	0 986 430 081	
<b>Golf II</b>									
1.6 D [19, 1G]	1,6	40	JP		D 08.83-10.91	4	0 432 217 164		
						WW	4	0 432 217 207	0 986 430 189
					D 08.83-10.91	4	0 432 217 084	0 986 430 081	
			ME		09.85-08.92	4	0 432 217 164		
TD [19, 1G]	1,6	44	1V		08.89-07.92	4	0 432 217 214	0 986 430 235	
		51	JR		D 08.83-10.91	4	0 432 217 163		
					D 08.83-10.91	4	0 432 217 079	0 986 430 080	
			MF		05.88-10.91	4	0 432 217 163		
<b>Golf III</b>									
1.9 D [1H1]	1,9	47	1Y		11.91-12.97	4	0 432 217 240	0 986 430 187	
SDI [1H1]	1,9	47	AEY		01.95-12.97	4	0 432 193 794		
						4	0 432 193 795 <sup>1</sup>		
TD [1H1]	1,9	55	AAZ		11.91-12.97	4	0 432 217 284	0 986 430 206	
TD [1H1/1W1]	1,9	55	AAZ		08.92-07.98	4	0 432 193 732		
						4	0 432 193 734 <sup>1</sup>		
						4	0 432 217 284	0 986 430 206	
TDI [1H1]	1,9	81	AFN		03.96-12.97	4	0 432 193 744 <sup>1</sup>		
						4	0 432 193 746		
TDI [1H1/1W1]	1,9	66	1Z		08.95→	4	0 432 193 829 <sup>1</sup>		
						4	0 432 193 838		
TDI, TDI syncro [1H1]	1,9	66	AHU		08.96-12.97	4	0 432 193 829 <sup>1</sup>		
						4	0 432 193 838		
			ALE		05.96-12.97	4	0 432 193 693 <sup>1</sup>		
						4	0 432 193 695		
			1Z		09.93-07.96	4	0 432 193 829 <sup>1</sup>		
						4	0 432 193 838		
<b>Golf III Cabriolet</b>									
1.9 TDI [1E7]	1,9	66	AHU; 1Z		08.95-04.98	4	0 432 193 829 <sup>1</sup>		
						4	0 432 193 838		
			ALE		04.97-04.98	4	0 432 193 693 <sup>1</sup>		
						4	0 432 193 695		
		81	AFN		09.96-04.98	4	0 432 193 744 <sup>1</sup>		
						4	0 432 193 746		
<b>Golf III Variant</b>									
1.9 D [1H5]	1,9	47	1Y		07.93-02.99	4	0 432 217 240	0 986 430 187	
SDI [1H5]	1,9	47	AEY		01.95-02.99	4	0 432 193 794		
						4	0 432 193 795 <sup>1</sup>		
TD [1H5]	1,9	55	AAZ		07.93-02.99	4	0 432 217 284	0 986 430 206	





◀ VW

1.9 TDI [1H5]	1,9	66	ALE	05.97-02.99	4	0 432 193 693 <sup>1</sup>
					4	0 432 193 695
		81	AFN	02.96-02.99	4	0 432 193 744 <sup>1</sup>
					4	0 432 193 746
TDI syncro [1H5]	1,9	66	ALE	05.96-12.97	4	0 432 193 829 <sup>1</sup>
					4	0 432 193 838
TDI, TDI syncro [1H5]	1,9	66	AHU	08.96-02.99	4	0 432 193 829 <sup>1</sup>
					4	0 432 193 838
			1Z	07.93-07.96	4	0 432 193 829 <sup>1</sup>
					4	0 432 193 838

**Golf IV**

1.9 SDI [1J1]	1,9	50	AGP	10.97-04.01	4	0 432 193 732
					4	0 432 193 734 <sup>1</sup>
			AQM	11.98-04.02	4	0 432 193 597 <sup>1</sup>
				05.02-05.04	4	0 432 193 573 <sup>1</sup>
					4	0 432 193 599
TDI [MY08]	1,9	66	AGR	04.07→	4	0 432 193 732
					4	0 432 193 734 <sup>1</sup>
TDI [1J1]	1,9	66	ALH	10.97-04.02	AG	4 0 432 193 702
						4 0 432 193 704 <sup>1</sup>
					GS	4 0 432 193 693 <sup>1</sup>
						4 0 432 193 695
				05.02-05.04	AG	4 0 432 193 584 <sup>1</sup>
						4 0 432 193 702
					GS	4 0 432 193 579 <sup>1</sup>
						4 0 432 193 695
		81	AHF	10.97-04.02	4	0 432 193 744 <sup>1</sup>
					4	0 432 193 746
				05.00-12.05	4	0 432 193 594
					4	0 432 193 738 <sup>1</sup>
				05.02-05.04	4	0 432 193 577 <sup>1</sup>
					4	0 432 193 746
			ASV	05.00-04.02	4	0 432 193 592 <sup>1</sup>
					4	0 432 193 594
				05.02-05.04	4	0 432 193 542 <sup>1</sup>
					4	0 432 193 594
TDI [9B1]	1,9	66	AGR	07.01-03.07	4	0 432 193 732
					4	0 432 193 734 <sup>1</sup>
			ALH	07.01-03.07	AG	4 0 432 193 702
						4 0 432 193 704 <sup>1</sup>
					GS	4 0 432 193 693 <sup>1</sup>
						4 0 432 193 695
TDI, TDI 4 Motion [1J1]	1,9	66	AGR	10.97-09.02	4	0 432 193 732
					4	0 432 193 734 <sup>1</sup>

**Golf IV Cabriolet**

1.9 TDI [1E7]	1,9	66	AHU	04.98-06.00	4	0 432 193 829 <sup>1</sup>	
					4	0 432 193 838	
			ALE	04.98-12.01	4	0 432 193 693 <sup>1</sup>	
					4	0 432 193 695	
			81	AFN	04.98-08.99	4	0 432 193 744 <sup>1</sup>
					4	0 432 193 746	
			AVG	08.99-10.00	4	0 432 193 744 <sup>1</sup>	
					4	0 432 193 746	

**Golf IV Station Wagon**

1.9 TDI [1J5]	1,9	81	AHF	04.02-12.05	4	0 432 193 594
					4	0 432 193 738 <sup>1</sup>





Golf IV Variant											
1.9 SDI [1J5]	1,9	50	AGP	05.00-04.01	4	0 432 193 732					
						4 0 432 193 734 <sup>1</sup>					
						AQM	05.99-04.02	4	0 432 193 597 <sup>1</sup>		
									4 0 432 193 599		
									05.02-06.06		
4 0 432 193 573 <sup>1</sup>											
4 0 432 193 599											
TDI [1J5]	1,9	66	ALH	05.99-04.02	AG	4 0 432 193 702					
						4 0 432 193 704 <sup>1</sup>					
					GS	4 0 432 193 693 <sup>1</sup>					
						4 0 432 193 695					
					05.02-06.06	AG	4 0 432 193 584 <sup>1</sup>				
							4 0 432 193 702				
					GS	4 0 432 193 579 <sup>1</sup>					
						4 0 432 193 695					
					81	AHF	05.99-04.02	4 0 432 193 744 <sup>1</sup>			
								4 0 432 193 746			
05.02-06.06	4 0 432 193 577 <sup>1</sup>										
	4 0 432 193 746										
	4 0 432 193 592 <sup>1</sup>										
4 0 432 193 594											
05.00-04.02	ASV	4 0 432 193 594									
		4 0 432 193 594									
		05.00-06.06									
		4 0 432 193 594									
		05.02-06.06									
4 0 432 193 542 <sup>1</sup>											
4 0 432 193 594											
TDI, TDI 4 Motion [1J5]	1,9	66	AGR	05.99-04.02	4	0 432 193 732					
						4 0 432 193 734 <sup>1</sup>					
						05.99-09.02					
4 0 432 193 732											
4 0 432 193 734 <sup>1</sup>											
Iltis											
1.6 D [183]	1,6	51	1C	08.87-12.88	4	0 432 217 079 0 986 430 080					
Jetta											
1.6 D [1G2, 19E]	1,6	40	JP	D 01.84-10.91	4	0 432 217 207 0 986 430 189					
						WW 4 0 432 217 164					
					D Turbo [1G2, 19E]	1,6	44	1V	D 01.84-10.91	4 0 432 217 084 0 986 430 081	
										08.89-07.92	
										4 0 432 217 214 0 986 430 235	
51	JR	D 01.84-10.91	4 0 432 217 163								
			D 01.84-10.91								
			4 0 432 217 079 0 986 430 080								
MF	CH	08.84-07.92	4 0 432 217 163								
			4 0 432 217 163								
1.9 TD [1H2/1W2]	1,9	55	AAZ	08.92-07.98	4	0 432 217 284 0 986 430 206					
TDI [1H2/1W2]	1,9	66	1Z	08.95→	4	0 432 193 794					
						4 0 432 193 795 <sup>1</sup>					
Jetta IV											
1.9 TDI	1,9	81	AHF	09.99-12.05	4	0 432 193 746					
Lupo											
1.7 SDI [6X1]	1,7	42	AKU	10.98-07.05	4	0 432 193 682					
						Fg.Nr. →6E..2..010 000 →6X..2..080 000					
						10.98-04.02					
4 0 432 193 680 <sup>1</sup>											
4 0 432 193 544 <sup>1</sup>											
Fg.Nr. 6E..3..000 001→ 6X..3..000 001→											
05.02-07.05											
4 0 432 193 544 <sup>1</sup>											
New Beetle											
1.9 TDI [1C1/9C1]	1,9	66	ALH	01.98-06.04	AG	4 0 432 193 702					
						4 0 432 193 704 <sup>1</sup>					
					GS	4 0 432 193 695					
						Fg.Nr. →1C..2..999 000					
						01.98-05.02					
4 0 432 193 693 <sup>1</sup>											
Fg.Nr. 1C..3..000 001→											
06.02-06.04											
4 0 432 193 744 <sup>1</sup>											
Passat											
1.6 D [32]	1,6	40	BE <222>	09.81-06.89	4	0 432 217 083 0 986 430 081					
						4 0 432 217 083 0 986 430 081					
D [32B]	1,6	40	JK	08.82-03.88	4	0 432 217 084 0 986 430 081					
						4 0 432 217 084 0 986 430 081					
						S 08.82-03.88					
4 0 432 217 079 0 986 430 080											
TD [32B]	1,6	51	CY	04.82-03.88	4	0 432 217 079 0 986 430 080					
TD [312/351/3A2]	1,6	59	RA	08.88-07.89	4	0 432 217 264					
1.9 D [312/351/3A2]	1,9	47	1Y	05.89-09.93	4	0 432 217 210					
						03.91-09.93					
						4 0 432 217 232					
TD [312/351/3A2]	1,9	55	AAZ	10.93-03.97	4	0 432 217 284 0 986 430 206					
						4 0 432 217 284 0 986 430 206					





◀ VW

1.9 TDI [3B2]	1,9	66	AHH	08.97-11.00	4	0 432 193 702		
			AHU			10.96-11.00	4	0 432 193 704 <sup>1</sup>
TDI [312/35I/3A2]	1,9	66	AHU	08.96-12.96	4	0 432 193 829 <sup>1</sup>		
			1Z			10.93-07.96	4	0 432 193 829 <sup>1</sup>
			81	AFN	03.96-03.97	4	0 432 193 744 <sup>1</sup>	
							0 432 193 746	
TDI, TDI syncro [3B2]	1,9	81	AFN	10.96-11.00	4	0 432 193 744 <sup>1</sup>		
			AVG			08.99-11.00	4	0 432 193 744 <sup>1</sup>
2.5 TDI [3B3]	2,5	120	BDG	05.03-05.05	6	0 432 133 783 <sup>1</sup>		
						0 432 133 794		
TDI, TDI syncro [3B2]	2,5	110	AFB	08.98-11.00	6	0 432 133 833 <sup>1</sup>		
			AKN			08.98-11.00	6	0 432 133 835
			AG	GS	08.98-11.00	6	0 432 133 815 <sup>1</sup>	
					0 432 133 817			
TDI, TDI 4 Motion [3B3]	2,5	110	AKN	10.00-05.03	6	0 432 133 815 <sup>1</sup>		
						GS	08.98-11.00	6
			AG	GS	10.00-05.03	6	0 432 133 824	
					0 432 133 824			
TDI 4 Motion [3B3]	2,5	132	BAU	01.03-05.05	6	0 432 133 792 <sup>1</sup>		
						0 432 133 794		
			BDH	01.03-05.05	6	0 432 133 783 <sup>1</sup>		
					6	0 432 133 794		

**Passat Variant**

1.6 D [32B]	1,6	40	JK	08.82-03.88	4	0 432 217 083	0 986 430 081	
							0 432 217 084	0 986 430 081
				S 08.82-03.88	4			
TD [32B]	1,6	51	CY	04.82-03.88	4	0 432 217 079	0 986 430 080	
TD [315/35I/3A5]	1,6	59	RA	08.88-07.89	4	0 432 217 264		
1.9 D [315/35I/3A5]	1,9	47	1Y	05.89-09.93	4	0 432 217 210		
			AAZ	03.91-09.93	4	0 432 217 232		
TD [315/35I/3A5]	1,9	55		10.93-03.97	4	0 432 217 284	0 986 430 206	
TDI [3B5]	1,9	66	AHH	05.98-11.00	4	0 432 193 702		
			AHU			05.97-11.00	4	0 432 193 704 <sup>1</sup>
							4	0 432 193 829 <sup>1</sup>
TDI [315/35I/3A5]	1,9	66	AHU	08.96-03.97	4	0 432 193 829 <sup>1</sup>		
			1Z			10.93-07.96	4	0 432 193 838
			81	AFN	03.96-03.97	4	0 432 193 829 <sup>1</sup>	
							0 432 193 838	
TDI, TDI syncro [3B5]	1,9	81	AFN	05.97-11.00	4	0 432 193 744 <sup>1</sup>		
			AVG			08.99-11.00	4	0 432 193 746
							4	0 432 193 746
2.5 TDI [3B6]	2,5	120	BDG	05.03-05.05	6	0 432 133 783 <sup>1</sup>		
						0 432 133 794		
TDI, TDI syncro [3B5]	2,5	110	AFB	08.98-11.00	6	0 432 133 833 <sup>1</sup>		
			AKN			05.99-11.00	6	0 432 133 835
			AG	GS	05.99-11.00	6	0 432 133 815 <sup>1</sup>	
					0 432 133 817			
				6	0 432 133 822 <sup>1</sup>			
				6	0 432 133 824			





2.5 TDI, TDI 4 Motion [3B6]	2,5	110	AKN	10.00-05.03	AG	6	0 432 133 815 <sup>1</sup>
						6	0 432 133 817
TDI 4 Motion [3B6]	2,5	132	BAU	01.03-05.05		6	0 432 133 822 <sup>1</sup>
						6	0 432 133 824
			BDH	01.03-05.05		6	0 432 133 792 <sup>1</sup>
						6	0 432 133 794
			6	0 432 133 783 <sup>1</sup>			
			6	0 432 133 794			

**Polo**

1.3 D [86,87]	1,3	33	MN	Mot.Nr. MN 054 044→	10.89-08.90	4	0 432 217 208
				Mot.Nr. →MN 054 043	08.86-10.89	4	0 432 217 213
1.4 D [80]	1,4	35	1W		10.90-09.94	4	0 432 217 208
1.7 SDI [6N1]	1,7	42	AHG		04.97-12.99	4	0 432 193 707 <sup>1</sup>
						4	0 432 193 709
SDI [6N2]	1,7	42	AHG		10.99-09.01	4	0 432 193 707 <sup>1</sup>
						4	0 432 193 709
			AKU	10.99-09.01		4	0 432 193 680 <sup>1</sup>
						4	0 432 193 682
1.9 D [6N1]	1,9	47	AEF		10.94-12.99	4	0 432 217 240 0 986 430 187
						4	0 432 193 794
D [6N2]	1,9	47	AEF		10.99-09.01	4	0 432 193 795 <sup>1</sup>
						4	0 432 193 795 <sup>1</sup>
SDI	1,9	47	ASY		05.02→	4	0 432 217 240 0 986 430 187
						4	0 432 193 597 <sup>1</sup>
SDI [6N2]	1,9	47	AGD		10.99-09.01	4	0 432 193 599
						4	0 432 193 794
SDI [9N1]	1,9	47	ASX		10.99-09.01	4	0 432 193 732
						4	0 432 193 734 <sup>1</sup>
			ASY	09.01-05.05		4	0 432 193 732
						4	0 432 193 734 <sup>1</sup>
SDI [9N2]	1,9	47	ASY		11.03-05.07	4	0 432 193 599
						4	0 432 193 599
SDI [9N3]	1,9	47	ASY		04.05-12.09	4	0 432 193 573 <sup>1</sup>
						4	0 432 193 573 <sup>1</sup>

**Polo Classic**

1.3 D [86,87]	1,3	33	MN	Mot.Nr. MN 054 044→	10.89-08.90	4	0 432 217 208
				Mot.Nr. →MN 054 043	08.86-10.89	4	0 432 217 213
1.4 D [80]	1,4	35	1W		10.90-09.94	4	0 432 217 208
1.7 SDI [6V2]	1,7	44	AKW		11.97-08.99	4	0 432 193 680 <sup>1</sup>
						4	0 432 193 682
1.9 D [6V2]	1,9	47	1Y		01.96-04.96	4	0 432 217 240 0 986 430 187
						4	0 432 217 240 0 986 430 187
SDI	1,9	47	1Y <M9N>		05.96→	4	0 432 217 240 0 986 430 187
						4	0 432 193 794
SDI [6V2]	1,9	47	AEY		12.95-08.99	4	0 432 193 794
						4	0 432 193 795 <sup>1</sup>
			AGP	10.99-09.01		4	0 432 193 597 <sup>1</sup>
						4	0 432 193 599
AQM	10.99-09.01		4	0 432 193 597 <sup>1</sup>			
			4	0 432 193 599			
TDI	1,9	66	AGR		09.00→	4	0 432 193 732
						4	0 432 193 734 <sup>1</sup>
TDI [6V2]	1,9	66	AGR		10.99-09.01	4	0 432 193 732
						4	0 432 193 734 <sup>1</sup>
			AHU	07.96-08.99		4	0 432 193 829 <sup>1</sup>
						4	0 432 193 838
			4	0 432 217 240 0 986 430 187			





◀ VW

1.9 TDI [6V2]	1,9	66	ALE	11.97-08.99	4	0 432 193 693 <sup>1</sup>
					4	0 432 193 695
			ALH	10.99-09.01	4	0 432 193 693 <sup>1</sup>
					4	0 432 193 695
		81	AFN	08.98-08.99	4	0 432 193 744 <sup>1</sup>
			ASV	10.99-09.01	4	0 432 193 592 <sup>1</sup>
				4	0 432 193 594	

**Polo Coupé**

1.3 D [86,87]	1,3	33	MN	Mot.Nr. MN 054 044→	10.89-08.90	4	0 432 217 208
				Mot.Nr. →MN 054 043	08.86-10.89	4	0 432 217 213
					10.90-09.94	4	0 432 217 208

**Polo Sedan**

1.9 SDI	1,9	47	ASY	11.02→	4	0 432 193 597 <sup>1</sup>
					4	0 432 193 599

**Polo Variant**

1.7 SDI [6V5]	1,7	44	AKW	11.97-08.99	4	0 432 193 680 <sup>1</sup>		
					4	0 432 193 682		
1.9 SDI [6V5]	1,9	47	AEY	06.97-08.99	4	0 432 193 794		
					4	0 432 193 795 <sup>1</sup>		
		50	AGP	10.99-09.01	4	0 432 193 597 <sup>1</sup>		
					4	0 432 193 599		
					4	0 432 193 597 <sup>1</sup>		
		AQM	10.99-09.01	4	0 432 193 599			
TDI [6V5]	1,9	66	AGR	10.99-09.01	4	0 432 193 732		
					4	0 432 193 734 <sup>1</sup>		
				AHU	06.97-08.99	4	0 432 193 829 <sup>1</sup>	
			4			0 432 193 838		
				ALE	11.97-08.99	4	0 432 193 693 <sup>1</sup>	
			4			0 432 193 695		
				ALH	10.99-09.01	4	0 432 193 693 <sup>1</sup>	
			4			0 432 193 695		
				81	AFN	06.98-08.99	4	0 432 193 744 <sup>1</sup>
			4				0 432 193 746	
	ASV	10.99-09.01	4		0 432 193 592 <sup>1</sup>			
4			0 432 193 594					

**Santana**

1.6 D [32]	1,6	40	JK	06.85-03.88	4	0 432 217 083	0 986 430 081
					4	0 432 217 084	0 986 430 081
D Turbo [32]	1,6	51	CY	06.85-03.88	4	0 432 217 079	0 986 430 080

**Sharan**

1.9 TDI [7M8]	1,9	66	AHU; 1Z	09.95-02.00	4	0 432 193 829 <sup>1</sup>
					4	0 432 193 838
			81		AFN; AVG	09.96-02.00
				4	0 432 193 746	

**Vento**

1.9 D [1H2]	1,9	47	1Y	11.91-12.97	4	0 432 217 240	0 986 430 187	
					4	0 432 193 794		
SDI [1H2]	1,9	47	AEY	01.95-12.97	4	0 432 193 794		
					4	0 432 193 795 <sup>1</sup>		
TD [1H2]	1,9	55	AAZ	11.91-12.97	4	0 432 217 284	0 986 430 206	
TDI [1H2]	1,9	66	AHU	08.96-12.97	4	0 432 193 829 <sup>1</sup>		
					4	0 432 193 838		
					ALE	05.97-12.97	4	0 432 193 693 <sup>1</sup>
			4				0 432 193 695	
					1Z	09.93-07.96	4	0 432 193 829 <sup>1</sup>
			4				0 432 193 838	
					81	AFN	02.96-12.97	4
4	0 432 193 746							





l/ccm



kW/(PS)



Typ



Zyl.



## ALFA ROMEO

## AR 6

10	2,5	53/55	8144.61.200; 8144.67.220	04.85-12.89	4	0 432 297 034	0 986 430 144
13	2,5	53	8144.61.200	04.85-02.86	4	0 432 297 034	0 986 430 144
14	2,5	55	8144.67.220	03.86-12.89	4	0 432 297 034	0 986 430 144
Turbo	2,5	68	8144.21.220	09.86-12.89	4	0 432 191 829	

## AR 8

30	2,5	53	8140.61.200	04.78-12.89	4	0 432 297 034	0 986 430 144
35	2,5	53	8140.61.200	04.78-12.89	4	0 432 297 034	0 986 430 144
Turbo	2,5	68	8140.21.200 D.I.	04.85-12.88	4	0 432 191 829	
40	2,5	53	8140.61.200	04.78-12.88	4	0 432 297 034	0 986 430 144
Turbo	2,5	68	8140.21.200 D.I.	04.85-12.88	4	0 432 191 829	

## ASTRA

## BM

44 D 12 R	8,1	118	OM-8360.05.200	04.91→	6	0 432 281 710	
201	8,0	118	OM-8360.05.200; OM-8360.05.300	06.79→	6	0 432 281 710	

## AVIA

## A

21 T	3,6	76	D421.76.01 <Euro 2>	10.96-12.98	4	0 432 133 831	
31 T	3,6	76	D421.76.01 <Euro 2>	10.96-12.98	4	0 432 133 831	
60	3,6	76	D421.76.00 <Euro 2>	10.96-12.98	4	0 432 133 831	
		85	D421.85.00 <Euro 2>	01.97-07.00	4	0 432 133 828	
75	3,6	76	D421.76.00 <Euro 2>	10.96-12.98	4	0 432 133 831	
		85	D421.85.00 <Euro 2>	01.97-07.00	4	0 432 133 828	

## CHERKASSKY BUS

## Bogdan

A092	4,8	107	4HE1-XS <Euro 2>	06.03→	4	9 430 613 139	
			4HE1-XS <Euro 3>	06.08→	4	9 430 613 447 <sup>1</sup>	
A0921	4,8	107	4HE1-XS <Euro 2>	12.04→	4	9 430 613 139	
			4HE1-XS <Euro 3>	01.08→	4	9 430 613 447 <sup>1</sup>	
A09202	4,6	89	4HG1-T <Euro 2>	12.04→	4	9 430 613 635	
A09212	4,6	89	4HG1-T <Euro 2>	12.04→	4	9 430 613 635	

## CHEVROLET

## D

40	4,0	68	S4 <Euro 1>	03.92-09.95	4	9 430 082 736	
				10.95-10.96	4	9 430 082 764	

## G20

6.2	6,2	97		09.82-08.90	8	0 432 217 092	
				09.90-08.91 U26	8	0 432 217 275	
				09.91-08.93	8	0 432 217 275	

## G30

6.2	6,2	110		09.82-08.91	8	0 432 217 092	
				09.91-08.93	8	0 432 217 275	
6.5	6,5	116		09.93-08.96	8	0 432 217 275	

## Luv

3.0 D-MAX	3,0	96	4JH1-TC	09.04→	4	9 430 613 961	
-----------	-----	----	---------	--------	---	---------------	--





◀ CHEVROLET

Serie D						
20	3,9	66	Q20B4236	01.85-02.92	4	9 430 082 723
	4,0	68	S4 <Euro 1>	03.92-09.95	4	9 430 082 736
Plus	4,0	99	S4T <Euro 1>	10.95-10.95	4	9 430 082 764
				03.92-08.95	4	9 430 082 737
Turbo	4,0	88	S4T	09.95-10.96	4	9 430 082 766
				03.92-08.95	4	9 430 082 737
				09.95-08.97	4	9 430 082 766
Silverado						
4.1 D	4,1	66	S4	11.96-12.01	4	F 000 439 008

**CITROEN**

C						
25 1.9 D	1,9	51	D9B <XUD9A>	07.87-03.88	BO	4 0 432 217 181
				04.88-03.94	BO	4 0 432 217 201
35 2.5 D	2,5	50	CRD93B <B 25/637>	01.80-10.90	BO	4 0 432 287 048
45 2.5 D	2,5	50	CRD93B <B 25/637>	06.82-10.90	BO	4 0 432 287 048
Jumper						
1.9 D [23]	1,9	51	DJY <XUD9>; D9B <XUD9AU>	02.94-02.02		4 0 432 217 248 0 986 430 244
						4 0 432 217 245
D Turbo [23]	1,9	66-68	DHX <XUD9UTF>; D8C <XUD9UTF>	02.94-02.02		4 0 432 217 268 0 986 430 381
2.5 D [23]	2,5	63	T9A <DJ5>	02.94-02.02		4 0 432 193 728
TDi [23]	2,5	79	THX <DJ5TED>	10.96-02.02		4 0 432 117 002
2.8 T	2,8	77	8140 43	12.01-08.05		4 0 432 117 002

**DAF**

CF						
65 .180	6,2	133	NS 133 M <EURO 2>	03.98-05.00		6 0 432 191 644
				02.98-04.02	TW	6 0 432 191 593
.210	6,2	156	NS 156 M <EURO 2>			6 0 432 191 647
.240	6,2	177	NS 177 M <EURO 2>	03.98-03.01		6 0 432 191 593
75 .250	9,2	183	PE 183 <Euro 3>	12.99-06.02		6 0 432 191 470
				02.01-02.07	MEB	6 0 432 191 254
.250, .290, .320	9,2	183/212/235	PF 183 <Euro 2>; PF 212 <Euro 2>; PF 235 <Euro 2>	12.97-04.02		6 0 432 191 570
.290, .320	9,2	212/235	PE 212 <Euro 3>; PE 235 <Euro 3>	01.99-02.02		6 0 432 191 470
.310	9,2	228	PE 228 <Euro 3>	02.01-07.07	MEB, TW	6 0 432 191 254
						6 0 432 191 382
.360	9,2	265	PE 265 <Euro 3>	02.01-05.07	TW	6 0 432 191 254
						6 0 432 191 382
85 .250, .380, .430	12,6	250/280/315	XF 250 <Euro 2>; XF 280 <Euro 2>; XF 315 <Euro 2>	10.97-09.02		6 0 432 191 583
						6 0 432 191 504
.340	12,6	250	XE 250 <Euro 3>	07.99-01.02		6 0 432 191 504
.380	12,6	280	XE 280 <Euro 3>	09.06-01.08		6 0 432 191 381
				08.99-02.02		6 0 432 191 504
.430	12,6	315	XE 315 <Euro 3>	06.01-12.07		6 0 432 191 381
				09.99-01.02		6 0 432 191 504
.480	12,6	355	XE 355 <Euro 3>	01.01-10.07		6 0 432 191 381
				10.01-10.07		6 0 432 191 381
F..						
900 DF	6,2	85	DF 615	11.81-11.88		6 0 432 281 111
1100 DNTD	6,2	116	DNTD 620	12.86-11.89	TW	6 0 432 191 775
						6 0 432 191 819
1300 DF	6,2	85	DF 615	07.78-10.88		6 0 432 281 111
						6 0 432 191 776
DNT	6,2	133	DNT 620	12.86-02.90	TW	6 0 432 191 776
						6 0 432 191 820
DNTD	6,2	116	DNTD 620	12.86-02.89	TW	6 0 432 191 775
						6 0 432 191 819
DT	6,2	113	DT 615	07.78-02.90		6 0 432 281 106







<b>1500 DF</b>	6,2	85	DF 615	07.78-08.91	6	<b>0 432 281 111</b>
DT	6,2	113	DT 615	07.78-08.91	6	<b>0 432 281 106</b>
<b>1600 DF</b>	6,2	93	DF 615	06.73-08.91	6	<b>0 432 281 111</b>
DT	6,2	113	DT 615	02.74-08.91	6	<b>0 432 281 106</b>
<b>1700 DNS, DNT</b>	6,2	133/156	DNS 620; DNT 620	12.86-02.95	6	<b>0 432 191 776</b>
DNTD	6,2	116	DNTD 620	12.86-12.88 TW	6	<b>0 432 191 775</b>
					6	<b>0 432 191 776</b>
					6	<b>0 432 191 819</b>
<b>1800 DT</b>	6,2	113	DT 615	02.74-08.91	6	<b>0 432 281 106</b>
<b>1900 DNS</b>	6,2	156	DNS 620	12.86-09.93 TW	6	<b>0 432 191 776</b>
					6	<b>0 432 191 820</b>
DNT	6,2	132	DNT 620	12.86-09.93 TW	6	<b>0 432 191 776</b>
					6	<b>0 432 191 820</b>
<b>2100 DHT</b>	8,3	162-167	DHT 825	11.81-08.91	6	<b>0 432 291 702</b>
DHTD	8,3	151	DHTD 825	07.81-08.91	6	<b>0 432 291 694</b>
<b>2103 DH</b>	8,3	115	DH 825	01.82-08.91 CSA	6	<b>0 432 281 728</b>
DHR	8,3	150	DHR 825	01.82-08.91	6	<b>0 432 281 711</b>
<b>2105 DF</b>	6,2	85	DF 615	07.78-08.91	6	<b>0 432 281 111</b>
DH	8,3	115	DH 825	07.78-08.91 CSA	6	<b>0 432 281 728</b>
DHR	8,3	150	DHR 825	07.78-08.91	6	<b>0 432 281 711</b>
DHT	8,3	167	DHT 825	01.87-08.91 TW	6	<b>0 432 191 745</b>
					6	<b>0 432 291 702</b>
DHTD	8,3	151	DHTD 825	07.81-08.91	6	<b>0 432 291 694</b>
<b>2300 DHT</b>	8,3	162	DHT 825	11.81-08.91	6	<b>0 432 291 702</b>
HT	8,3	168	HT 168	01.90-08.91	6	<b>0 432 191 745</b>
<b>2303 DHU</b>	8,3	169	DHU 825	11.81-08.91 CSA	6	<b>0 432 281 720</b>
<b>2305 DHR</b>	8,3	150	DHR 825	07.78-08.91	6	<b>0 432 281 711</b>
DHU	8,3	169	DHU 825	07.78-08.91 CSA	6	<b>0 432 281 720</b>
<b>2500 DHS</b>	8,3	184-195	DHS 825	02.82-08.91	6	<b>0 432 291 702</b>
<b>2505 DHS</b>	8,3	184-195/217	DHS 825; DHS 825SM	02.82-08.91	6	<b>0 432 291 702</b>
<b>2525 DHS</b>	8,3	184-195	DHS 825	02.82-08.91	6	<b>0 432 291 702</b>
<b>2535 DHS</b>	8,3	184-195	DHS 825	02.82-08.91	6	<b>0 432 291 702</b>
<b>2700 HS ATi</b>	8,3	200	HS 200 <HS825>	01.90-12.93	6	<b>0 432 191 746</b>
<b>2800 DKS</b>	11,6	228-236	DKS 1160	01.74-09.91	6	<b>0 432 281 100</b>
DKSE	11,6	206	DKS 1160 E	01.80-07.90	6	<b>0 432 281 100</b>
DKTD	11,6	188	DKTD 1160	01.74-09.91	6	<b>0 432 281 101</b>
DKV, DKXE ATi	11,6	206-212	DKV 1160; DKX-E 1160 ATi	05.83-09.91	6	<b>0 432 291 668</b>
<b>2803 DKS</b>	11,6	228	DKS 1160	01.74-09.91	6	<b>0 432 281 100</b>
DKTD	11,6	188	DKTD 1160	01.74-09.91	6	<b>0 432 281 101</b>
<b>2805 DKS</b>	11,6	228	DKS 1160	01.74-09.91	6	<b>0 432 281 100</b>
DKSE	11,6	206	DKS 1160 E	01.80-07.90	6	<b>0 432 281 100</b>
DKTD	11,6	188	DKTD 1160	01.74-09.91	6	<b>0 432 281 101</b>
<b>2900 KV ATi</b>	11,6	212	KV 212	01.90-12.93	6	<b>0 432 291 668</b>
<b>3200 KS ATi</b>	11,6	238	KS 238	01.90-10.92	6	<b>0 432 291 668</b>
<b>3300 DKV</b>	11,6	206	DKV 1160	05.83-09.91	6	<b>0 432 281 101</b>
DKX	11,6	243	DKX 1160	06.81-09.91	6	<b>0 432 281 100</b>
DKX ATi	11,6	260	DKX 1160 ATi	06.85-09.91	6	<b>0 432 291 668</b>
<b>3305 DKX</b>	11,6	243	DKX 1160	06.81-09.91	6	<b>0 432 281 100</b>
<b>3325 DKX</b>	11,6	243	DKX 1160	06.81-09.91	6	<b>0 432 281 100</b>
DKX ATi	11,6	260	DKX 1160 ATi	01.89-09.91	6	<b>0 432 291 668</b>
<b>3600 DKZ ATi</b>	11,6	274	DKZ 1160 ATi	06.85-09.91	6	<b>0 432 291 668</b>
<b>MB</b>						
<b>200 DKDL</b>	11,6	121	DKDL 1160	11.80-07.90	6	<b>0 432 281 097</b>
<b>N..</b>						
<b>2826 DKA</b>	11,6	169	DKA 1160	10.80-09.91	6	<b>0 432 281 099</b>
DKS	11,6	228	DKS 1160	01.81-09.91	6	<b>0 432 281 100</b>
DKTD	11,6	188	DKTD 1160	01.82-09.91	6	<b>0 432 281 101</b>
<b>SB</b>						
<b>201 DKDL</b>	11,6	121	DKDL 1160	11.80-07.90	6	<b>0 432 281 097</b>
<b>2005 DH</b>	8,3	115	DH 825	05.80-12.93 CSA	6	<b>0 432 281 728</b>





◀ DAF

XF						
95 .380	12,6	280	XE 280 C <Euro 3>	04.98-04.03	6	0 432 191 504
			XF280M <Euro 2>	01.97-04.02 TW	6	0 432 191 583
.380, .430, .480	12,6	280/315/355	XE 280 <Euro 3>; XE 315 <Euro 3>; XE 355 <Euro 3>	01.02-12.07 TW	6	0 432 191 315
					6	0 432 191 381
.430	12,6	315	XE 315 C <Euro 3>	01.99-08.03	6	0 432 191 504
			XF315M <Euro 2>	01.97-12.02	6	0 432 191 583
.460	12,6	335	XE 335 <Euro 3>	02.04-02.07	6	0 432 191 315
.480	12,6	355	XE 355 C <Euro 3>	05.98-09.03 TW	6	0 432 191 315
					6	0 432 191 504
			XF355M <Euro 2>	01.97-04.02 TW	6	0 432 191 583
.530	12,6	390	XE 390 C <Euro 3>	11.99-09.03	6	0 432 191 504
				11.01-01.07 TW	6	0 432 191 315
					6	0 432 191 381
45						
.130	5,9	96	CN 95 <6 BTA 130>	05.91-12.97 TW	6	0 432 133 877
.150 Turbo	5,9	107	CB 107 <6 BTA 145>	05.91-12.97 TW	6	0 432 133 877
.160 Turbo	5,9	119	CT 119 <6 BTA 160>	05.91-12.97 TW	6	0 432 133 877
65						
.180 ATi	6,2	133	NS 133 L <EURO 1>	01.93-12.97 TW	6	0 432 191 644
					6	0 432 191 702
			NS 133 M <EURO 2>	01.93-08.98 TW	6	0 432 191 644
					6	0 432 191 647
.210 ATi	6,2	156	NS 156 L <EURO 1>	01.93-12.96	6	0 432 191 702
			NS 156 M <EURO 2>	01.93-04.02	6	0 432 191 647
.240 ATi	6,2	177	NS 177 L	03.96-08.98	6	0 432 191 593
75						
.240 ATi	8,7	180	RS 180 L <Euro 1>	01.92-06.97 TW	6	0 432 191 570
					6	0 432 191 703
					6	0 432 191 704
				07.92-07.92 TW	6	0 432 191 709
				RS 180 M <Euro 2>	03.93-12.99 TW	6
				6	0 432 191 704	
				05.93-12.99 TW	6	0 432 191 703
.270 ATi	8,7	200	RS 200 L <Euro 1>; RS 200 M <Euro 2>	02.92-04.02 TW	6	0 432 191 673
					6	0 432 191 704
.300 ATi	8,7	222	RS 222 L <Euro 1>	01.92-12.96 TW	6	0 432 191 673
				08.92-12.96	6	0 432 191 704
			RS 222 M <Euro 2>	05.93-12.98	6	0 432 191 673
85						
.300 ATi	11,6	222	WS 222 <Euro 1>	01.93-09.96 TW	6	0 432 291 543
.330 ATi	11,6	242	WS 242 <Euro 1/2>	02.90-12.98 TW	6	0 432 291 528
				07.92-12.98 TW	6	0 432 291 542
.360 ATi	11,6	268	WS 268 <Euro 1/2>	12.91-12.98 TW	6	0 432 291 528
					6	0 432 291 543
				07.92-12.98 TW	6	0 432 291 587
.400 ATi	11,6	295	WS 295 <Euro 1/2>	05.95-12.99 TW	6	0 432 291 528
					6	0 432 291 543
95						
.310 ATi	11,6	225	WS 225	01.87-02.88 TW	6	0 432 291 647
				01.87-12.95 TW	6	0 432 291 528
					6	0 432 291 603
					6	0 432 291 627
			03.88-12.95 CSA,TW	6	0 432 291 602	
.330 ATi	11,6	242	WS 242 <Euro 0/1>	06.90-11.95 TW	6	0 432 291 528
					6	0 432 291 587
					6	0 432 291 588





<b>.350</b> ATi	11,6	259	WS 259	02.87-02.88	TW	6	<b>0 432 291 627</b>
				02.87-01.96	CSA,TW	6	<b>0 432 291 602</b>
					TW	6	<b>0 432 291 543</b>
						6	<b>0 432 291 647</b>
			03.88-01.96	TW	6	<b>0 432 291 603</b>	
<b>.360</b> ATi	11,6	268	WS 268 <Euro 0/1/2>	10.89-12.97	TW	6	<b>0 432 291 528</b>
						6	<b>0 432 291 543</b>
						6	<b>0 432 291 561</b>
						6	<b>0 432 291 587</b>
						6	<b>0 432 291 588</b>
					6	<b>0 432 291 603</b>	
<b>.380</b> ATi	11,6	282	WS 282 L <Euro 1>	01.87-02.88	TW	6	<b>0 432 291 627</b>
				01.87-12.95	CSA,TW	6	<b>0 432 291 602</b>
					TW	6	<b>0 432 291 588</b>
						6	<b>0 432 291 647</b>
			03.88-12.95	TW	6	<b>0 432 291 603</b>	
<b>.400</b> ATi	11,6	295	WS 295 <Euro 0/1/2>	10.89-09.98	TW	6	<b>0 432 291 525</b>
						6	<b>0 432 291 528</b>
						6	<b>0 432 291 543</b>
						6	<b>0 432 291 561</b>
						6	<b>0 432 291 587</b>
					6	<b>0 432 291 588</b>	
<b>.430</b> ATi	11,6	315	WS 315 <Euro 0/1/2>	04.91-12.98		6	<b>0 432 191 583</b>
					TW	6	<b>0 432 291 525</b>
						6	<b>0 432 291 528</b>
						6	<b>0 432 291 543</b>
						6	<b>0 432 291 561</b>
					6	<b>0 432 291 603</b>	

**EBRO (MISA)**

<b>L</b>							
<b>35</b> S, SF	3,9	62	4.236	05.85-06.90		4	<b>0 432 291 646</b>
<b>45</b> , F	3,9	56-62	4.236	05.83-06.90		4	<b>0 432 291 646</b>
<b>60</b>	3,9	56-62	4.236	05.83-06.90		4	<b>0 432 291 646</b>
<b>80</b>	5,8	88	6.354.3	02.87-05.87		6	<b>0 432 291 682</b>
Turbo	3,9	72	4.236	05.85-06.90		4	<b>0 432 291 646</b>
<b>M</b>							
<b>100</b>	5,8	82-88	6.354.3	03.83-05.87		6	<b>0 432 291 682</b>
<b>125</b>	5,8	82-88	6.354.3	03.83-05.87		6	<b>0 432 291 682</b>
<b>130</b>	6,9	117	Nissan-FE6	08.85-07.89		6	<b>9 430 610 044</b>
<b>Trade</b>							
<b>2.0</b>	2,0	41-44	Nissan-LD 20 E	09.84-02.87		4	<b>9 430 610 001</b>
						4	<b>9 430 610 014</b>
<b>65</b>							
<b>/7</b> D	3,9	66-71	T4.236	02.84-06.90		4	<b>0 432 291 646</b>
<b>100</b>							
<b>/8</b> D	5,8	110-111	T6.354.3 CC	04.84-05.87		6	<b>0 432 291 682</b>

**FIAT**

<b>Ducato</b>							
<b>2.5</b> D	2,5	62	8140.67.2200	11.97-12.99		4	<b>0 432 297 057 0 986 430 532</b>
<b>2.8</b> D	2,8	63	8140.63.22.60 <PC/NA>	04.99-05.05		4	<b>0 432 117 002</b>
D Turbo	2,8	90	8140.43.22.00 <ID/TCA>	04.99-08.00		4	<b>0 432 193 666</b>
				09.00-05.05		4	<b>0 432 193 757 0 986 430 522</b>
<b>Ducato Cargo</b>							
<b>2.5</b> D	2,5	62	8140.67.2200	11.97-05.05		4	<b>0 432 297 057 0 986 430 532</b>





◀ FIAT

2.8 D	2,8	63	8140.63.22.60 <PC/NA>	04.99-05.05	4	0 432 117 002	
D Turbo	2,8	90	8140.43.22.00 <ID/TCA>	04.99-08.00	4	0 432 193 666	
				09.00-05.05	4	0 432 193 757	0 986 430 522
D Turbo Interc.	2,8	103,3	8140.23.22.00 <ID/TC>	10.99-05.05	4	0 432 193 757	0 986 430 522
<b>Ducato Combinato</b>							
2.8 D, iDTD	2,8	66/76	8140.63	06.98→	4	0 432 117 002	
<b>Ducato Furgon</b>							
2.8 D	2,8	66	8140.63	06.98-11.04	4	0 432 117 002	
<b>Ducato Furgon Maxi</b>							
2.8 D	2,8	66	8140.63	09.98-01.03	4	0 432 117 002	
<b>Ducato 10</b>							
1.9 D [279..]	1,9	52	149 B 1.000 <M1>	07.90-02.94 BO	4	0 432 217 129	
D [280..]	1,9	52	149 B 1.000	02.87-06.90 BO	4	0 432 217 129	
D, TD, TD CAT [230..]	1,9	51/59/60	230 A 2.000 <M1>; 230 A 3.000 <M2>; 230 A 4.000 <M3>	03.94-03.98	4	0 432 217 195	
TD [279..]	1,9	60	280 A 1.000 <M2>	07.90-02.94	4	0 432 217 172	
2.5 D [230..]	2,5	62	8140.67 <M4>	03.94-03.98	4	0 432 297 057	0 986 430 532
D [280..]	2,5	55	8144.67	01.86-06.90 BO	4	0 432 297 034	0 986 430 144
TD [279..]	2,5	70	8140.27 <M4>	11.91-02.94	4	0 432 191 733	
TD ECO [230..]	2,5	80	8140.47R <M7>	03.94-03.98	4	0 432 193 842 <sup>1</sup>	
					4	0 432 193 843	
TD EGR [230..]	2,5	85	8140.47 <M6>	03.94-03.98	4	0 432 193 845	0 986 430 256
TD EGR 4x4 [234..]	2,5	85	8140.47 <M6>	03.94-03.98	4	0 432 193 845	0 986 430 256
TD 4x4 [234..]	2,5	85	8140.47 <M5>				
			Mot.Nr. →1997700	03.94-03.98	4	0 432 193 845	0 986 430 256
2.8 D [230..]	2,8	64	8140.63 <M10>	04.98-03.02	4	0 432 117 002	
TD [230..]	2,8	90	8140.43 <M8>				
			Mot.Nr. →3050379	11.98-03.00	4	0 432 193 666	
			Mot.Nr. 3050380→	04.00-03.02	4	0 432 193 757	0 986 430 522
TD EGR [230..]	2,8	90	8140.43 <M9>				
			Mot.Nr. →3050379	11.98-03.00	4	0 432 193 666	
			Mot.Nr. 3050380→	04.00-03.02	4	0 432 193 757	0 986 430 522
TD EGR 4x4 [234..]	2,8	90	8140.43 <M9>				
			Mot.Nr. →3050379	11.98-03.00	4	0 432 193 666	
			Mot.Nr. 3050380→	04.00-03.02	4	0 432 193 757	0 986 430 522
TD 4x4 [234..]	2,8	90	8140.43 <M8>				
			Mot.Nr. →3050379	11.98-03.00	4	0 432 193 666	
			Mot.Nr. 3050380→	04.00-03.02	4	0 432 193 757	0 986 430 522
<b>Ducato 11</b>							
2.8 TD EGR 4x4 [247..]	2,8	90	8140.43 <M26>	10.02-08.06	4	0 432 193 757	0 986 430 522
TD, TD EGR [243..]	2,8	90	8140.43 <M25>; 8140.43 <M26>	10.02-08.06	4	0 432 193 757	0 986 430 522
<b>Ducato 12</b>							
2.5 D 4x4 [284..]	2,5	55	8144.67 <M1>	07.90-02.94 BO	4	0 432 297 034	0 986 430 144
TD 4x4 [284..]	2,5	70	8140.27 <M2>	11.91-02.94	4	0 432 191 733	
<b>Ducato 14</b>							
1.9 TD [280..]	1,9	60	280 A 1.000 <M2>	07.90-02.94	4	0 432 217 172	
TD, TD CAT [231..]	1,9	59/60	230 A 3.000 <M2>; 230 A 4.000 <M3>	03.94-03.98	4	0 432 217 195	
2.5 D [231..]	2,5	62	8140.67 <M4>	03.94-03.98	4	0 432 297 057	0 986 430 532
D [280..]	2,5	55	8144.67 <M3>	07.90-02.94 BO	4	0 432 297 034	0 986 430 144
D, D 4x4 [280..]	2,5	55	8144.67	01.86-06.90 BO	4	0 432 297 034	0 986 430 144
TD [231..]	2,5	85	8140.47 <M5>				
			Mot.Nr. →1997700	03.94-03.98	4	0 432 193 845	0 986 430 256
TD [280..]	2,5	70	8140.27 <M4>	11.91-02.94	4	0 432 191 733	
TD ECO [231..]	2,5	80	8140.47R <M7>	03.94-03.98	4	0 432 193 842 <sup>1</sup>	
					4	0 432 193 843	
TD ECO 4x4 [234..]	2,5	80	8140.47R <M7>	03.94-03.98	4	0 432 193 842 <sup>1</sup>	
					4	0 432 193 843	
TD EGR [231..]	2,5	85	8140.47 <M6>	03.94-03.98	4	0 432 193 845	0 986 430 256
TD EGR 4x4 [234..]	2,5	85	8140.47 <M6>	03.94-03.98	4	0 432 193 845	0 986 430 256
TD, TD 4x4 [280..]	2,5	68	8144.21	01.86-06.90 BO	4	0 432 191 829	





<b>2.8 D [231..]</b>	2,8	64	8140.63 <M10>	04.98-03.02	4	<b>0 432 117 002</b>
TD [231..]	2,8	90	8140.43 <M8>			
			Mot.Nr. →3050379	11.98-03.00	4	<b>0 432 193 666</b>
			Mot.Nr. 3050380→	04.00-03.02	4	<b>0 432 193 757 0 986 430 522</b>
TD EGR [231..]	2,8	90	8140.43 <M9>			
			Mot.Nr. →3050379	11.98-03.00	4	<b>0 432 193 666</b>
			Mot.Nr. 3050380→	04.00-03.02	4	<b>0 432 193 757 0 986 430 522</b>
TD EGR 4x4 [234..]	2,8	90	8140.43 <M9>			
			Mot.Nr. →3050379	11.98-03.00	4	<b>0 432 193 666</b>
			Mot.Nr. 3050380→	04.00-03.02	4	<b>0 432 193 757 0 986 430 522</b>
TD 4x4 [234..]	2,8	90	8140.43 <M8>			
			Mot.Nr. →3050379	11.98-03.00	4	<b>0 432 193 666</b>
			Mot.Nr. 3050380→	04.00-03.02	4	<b>0 432 193 757 0 986 430 522</b>

**Ducato 15**

<b>2.8 TD EGR 4x4, TD 4x4 [247..]</b>	2,8	90	8140.43 <M25>; 8140.43 <M26>	10.02-08.06	4	<b>0 432 193 757 0 986 430 522</b>
TD, TD EGR [244..]	2,8	90	8140.43 <M25>; 8140.43 <M26>	10.02-08.06	4	<b>0 432 193 757 0 986 430 522</b>

**Ducato 18**

<b>2.5 D [232..]</b>	2,5	62	8140.67 <M4>	03.94-03.98	4	<b>0 432 297 057 0 986 430 532</b>
D Maxi [280..]	2,5	55	8144.67	01.86-06.90 BO	4	<b>0 432 297 034 0 986 430 144</b>
D Maxi [282..]	2,5	55	8144.67 <M3>	07.90-02.94 BO	4	<b>0 432 297 034 0 986 430 144</b>
D 4x4 [234..]	2,5	62	8140.67 <M4>	03.94-03.98	4	<b>0 432 297 057 0 986 430 532</b>
TD [232..]	2,5	85	8140.47 <M5>			
			Mot.Nr. →1997700	03.94-03.98	4	<b>0 432 193 845 0 986 430 256</b>
TD ECO [232..]	2,5	80	8140.47R <M7>	03.94-03.98	4	<b>0 432 193 842<sup>1</sup></b>
					4	<b>0 432 193 843</b>
TD Maxi [280..]	2,5	68	8144.21	01.86-06.90 BO	4	<b>0 432 191 829</b>
TD Maxi [282..]	2,5	70	8140.27 <M4>	11.91-02.94	4	<b>0 432 191 733</b>
TD 4x4 [234..]	2,5	85	8140.47 <M5>			
			Mot.Nr. →1997700	03.94-03.98	4	<b>0 432 193 845 0 986 430 256</b>

<b>2.8 D [232..]</b>	2,8	64	8140.63 <M10>	04.98-03.02	4	<b>0 432 117 002</b>
D 4x4 [234..]	2,8	64	8140.63 <M10>	04.98-03.02	4	<b>0 432 117 002</b>
TD [232..]	2,8	90	8140.43 <M8>			
			Mot.Nr. →3050379	11.98-03.00	4	<b>0 432 193 666</b>
			Mot.Nr. 3050380→	04.00-03.02	4	<b>0 432 193 757 0 986 430 522</b>
TD [245..]	2,8	90	8140.43 <M25>	10.02-08.06	4	<b>0 432 193 757 0 986 430 522</b>
TD EGR [232..]	2,8	90	8140.43 <M9>			
			Mot.Nr. →3050379	11.98-03.00	4	<b>0 432 193 666</b>
			Mot.Nr. 3050380→	04.00-03.02	4	<b>0 432 193 757 0 986 430 522</b>
TD EGR 4x4 [234..]	2,8	90	8140.43 <M9>			
			Mot.Nr. →3050379	11.98-03.00	4	<b>0 432 193 666</b>
			Mot.Nr. 3050380→	04.00-03.02	4	<b>0 432 193 757 0 986 430 522</b>
TD 4x4 [234..]	2,8	90	8140.43 <M8>			
			Mot.Nr. →3050379	11.98-03.00	4	<b>0 432 193 666</b>
			Mot.Nr. 3050380→	04.00-03.02	4	<b>0 432 193 757 0 986 430 522</b>
TD 4x4 [247..]	2,8	90	8140.43 <M25>	10.02-08.06	4	<b>0 432 193 757 0 986 430 522</b>

**Talento**

<b>1.9 D</b>	1,9	51	149 B 1.000 <M1>	03.88-12.94 BO	4	<b>0 432 217 129</b>
--------------	-----	----	------------------	----------------	---	----------------------

**FORD**



<b>A</b>						
<b>0407</b>	2,5	50-51	4AB, 4CA	01.86-12.99	4	<b>0 432 191 836</b>
<b>Cargo</b>						
<b>0609</b>	4,2	63	90/5 AA-Dover	01.82-01.96 BO	4	<b>0 432 291 713</b>
<b>0709</b>	4,2	63	90/5 AA-Dover	01.82-01.96 BO	4	<b>0 432 291 713</b>
<b>0711</b>	6,0	81	110/6 AA-Dover	01.82-01.96 BO	6	<b>0 432 291 713</b>
<b>0713</b>	6,2	94	130/7 AA-Dover	01.82-01.87 BO	6	<b>0 432 291 713</b>
<b>0809 , K</b>	4,2	63	90/5 AA-Dover	01.82-01.96 BO	4	<b>0 432 291 713</b>
<b>0811</b>	6,0	81	110/6 AA-Dover	01.82-01.96 BO	6	<b>0 432 291 713</b>
<b>0813 , K</b>	6,2	94	130/7 AA-Dover <7HA>	01.82-01.96 BO	6	<b>0 432 291 713</b>
<b>0911</b>	6,0	81	110/6 AA-Dover	01.82-01.96 BO	6	<b>0 432 291 713</b>
<b>0913</b>	6,2	94	130/7 AA-Dover	01.82-01.96 BO	6	<b>0 432 291 713</b>



◀ FORD

0915	6,0	110	150/6 CA-Dover	01.82-01.96	6	0 432 291 712
1011	6,0	81	110/6 AA-Dover	01.82-06.94	6	0 432 291 713
1013	6,2	94	130/7 AA-Dover	01.82-06.94	6	0 432 291 713
1015	6,0	110	150/6 CA-Dover	12.84-06.94	6	0 432 291 712
1111	6,0	81	110/6 AA-Dover	01.82-06.94	6	0 432 291 713
1113	6,2	94	130/7 AA-Dover	01.82-06.94	6	0 432 291 713
1115	6,0	110	150/6 CA-Dover	01.82-06.94	6	0 432 291 712
1211	6,0	81	110/6 AA-Dover	01.82-06.94	6	0 432 291 713
1213	6,2	94	130/7 AA-Dover	01.82-06.94	6	0 432 291 713
1215	6,0	110	150/6 CA-Dover	12.84-06.94	6	0 432 291 712
1311	6,0	81	110/6 AA-Dover	01.82-06.94	6	0 432 291 713
1313	6,2	94	130/7 AA-Dover	01.82-06.94	6	0 432 291 713
1315	6,0	110	150/6 CA-Dover	01.82-06.94	6	0 432 291 712
1317	9,6	125	F6L 413 F	08.82-12.99	6	0 432 291 807 0 986 430 124
1320	9,6	150	F6L 413 FZ	08.82-06.93	6	0 432 291 698
				07.93-12.99	6	0 432 291 644
1413	6,2	94	130/7 AA-Dover	01.82-06.94	6	0 432 291 713
1415	6,0	110	150/6 CA-Dover	12.84-06.94	6	0 432 291 712
1513	6,2	94	130/7 AA-Dover	01.82-06.94	6	0 432 291 713
1515	6,0	110	150/6 CA-Dover	01.82-06.94	6	0 432 291 712
1517	9,6	125	F6L 413 F	08.82-12.99	6	0 432 291 807 0 986 430 124
1520	9,6	150	F6L 413 FZ	08.82-12.86	6	0 432 291 698
1613	6,2	94	130/7 AA-Dover	12.84-11.87	6	0 432 291 713
1615	6,0	110	150/6 CA-Dover	12.84-11.87	6	0 432 291 712
1617	9,6	125	F6L 413 F	04.82-11.87	6	0 432 291 807 0 986 430 124
1620	9,6	150	F6L 413 FZ	04.82-11.87	6	0 432 291 698
1713	6,2	94	130/7 AA-Dover	01.82-06.94	6	0 432 291 713
1913	6,2	94	130/7 AA-Dover	01.82-06.94	6	0 432 291 713
2015 S	6,0	110	150/6 CA-Dover	12.84-06.94	6	0 432 291 712
2115	6,0	110	150/6 CA-Dover	01.82-06.94	6	0 432 291 712
2420	9,6	150	F6L 413 FZ	10.82-06.93	6	0 432 291 698
				07.93-12.99	6	0 432 291 644
2817	9,6	125	F6L 413 F	04.82-12.99	6	0 432 291 807 0 986 430 124
2820 S	9,6	150	F6L 413 FZ	12.84-08.87	6	0 432 291 698
3020	9,6	150	F6L 413 FZ	04.82-06.93	6	0 432 291 698
				07.93-12.99	6	0 432 291 644
3220	9,6	150	F6L 413 FZ	04.82-08.87	6	0 432 291 698
<b>Cargo C</b>						
3224	8,3	177	6CT	04.92-12.97	6	0 432 191 812
<b>Econovan</b>						
2.0 D	2,0	41	RF <Mazda>	02.86-12.99	4	9 430 610 007
<b>Serie F</b>						
100 3.9 D 4x4	3,9	49		01.83-08.99	4	F 000 439 009
250	3,9	107	4BTAA	11.98-10.99	4	F 000 439 009
				11.99-03.06	4	F 000 439 011
	4,2	132	6.07 TCA	03.99-03.06	6	0 432 193 731
5.1	5,1	79	F 5 L 913	11.79-12.88	5	0 432 291 753 0 986 430 067
350	3,9	88	B3.9 120 P -5 <Euro III>	09.05-→	4	0 432 133 787
1000	3,9	64	D 229-4	01.79-08.92	4	9 430 082 289
<b>Transit</b>						
FT 80-190 [78]	2,5	50	York <D25>	05.84-02.86	4	0 432 191 836
FT 280 S 2.4 TDI [00]	2,4	66	<IDI24>	01.01-05.06	4	0 432 133 790
FT 300 S 2.4 TDI [00]	2,4	66	<IDI24>	01.01-05.06	4	0 432 133 790
FT 310 S 2.4 TDI [00]	2,4	88	<IDI24>	01.01-05.06	4	0 432 133 791
FT 330 L 2.4 TDI [00]	2,4	66	<IDI24>	01.01-05.06	4	0 432 133 790
					4	0 432 193 838
		88	<IDI24>	01.01-05.06	4	0 432 133 791
					4	0 432 193 838
FT 330 M 2.4 TDI [00]	2,4	66	<IDI24>	01.01-05.06	4	0 432 133 790
					4	0 432 193 838
		88	<IDI24>	01.01-05.06	4	0 432 133 791
					4	0 432 193 838





<b>FT 330 S</b> 2.4 TDI [00]	2,4	66	<IDI24>	01.01-05.06	4	<b>0 432 133 790</b>
					4	<b>0 432 193 838</b>
		74	<IDI24>		4	<b>0 432 193 838</b>
		88	<IDI24>		4	<b>0 432 133 791</b>
<b>FT 350 E</b> 2.4 TDI [00]	2,4	66	<IDI24>	01.01-05.06	4	<b>0 432 133 790</b>
					4	<b>0 432 193 838</b>
		88/96	<IDI24>		4	<b>0 432 133 791</b>
					4	<b>0 432 193 838</b>
<b>FT 350 L</b> 2.4 TDI [00]	2,4	66	<IDI24>	01.01-05.06	4	<b>0 432 133 790</b>
					4	<b>0 432 193 838</b>
		88/96	<IDI24>		4	<b>0 432 133 791</b>
					4	<b>0 432 193 838</b>
<b>FT 350 M</b> 2.4 TDI [00]	2,4	66	<IDI24>	01.01-05.06	4	<b>0 432 133 790</b>
					4	<b>0 432 193 838</b>
		88/96	<IDI24>		4	<b>0 432 133 791</b>
					4	<b>0 432 193 838</b>
<b>FT 430 E</b> 2.4 TDI [00]	2,4	96	<IDI24>	06.04-05.06	4	<b>0 432 133 791</b>
					4	<b>0 432 193 838</b>
<b>2.5 D 100 L, D 130-190</b> [86]	2,5	52	4... <D25N>	01.86-09.88 BO	4	<b>0 432 191 836</b>

**GMC (GENERAL MOTORS CORP.)**

<b>GMC</b>						
<b>3500 HD</b>	4,2	110	6.07T <Sprint 6.07T>	08.96-12.99	6	<b>0 432 193 691</b>
					6	<b>0 432 193 565</b>

**GOLAZ GOLITSINO**

<b>Serie 6000</b>						
<b>6228</b>	9,0	221	DC 9.03 <Euro 3>	01.06→	6	<b>0 432 191 464</b> <sup>1</sup>
<b>6298</b>	9,0	221	DC 9.03 <Euro 3>	01.00→	6	<b>0 432 191 464</b> <sup>1</sup>
<b>Serie 50000</b>						
<b>52911</b>	9,0	221	DC 9.03 <Euro 3>	01.07→	6	<b>0 432 191 464</b> <sup>1</sup>

**IKARUS**

<b>Serie 200</b>						
<b>255</b>	10,4	141	Raba/D 2156 HM6U	01.69→	6	<b>0 432 221 849</b>
<b>260 .22</b>	10,4	141	Raba/D 2156 HM6U	06.78→	6	<b>0 432 221 849</b>
<b>.29</b>	10,7	162	Raba/D 2356 HM6U	01.81→	6	<b>0 432 221 865</b>
<b>280 .25</b>	10,7	162	Raba/D 2356 HM6U	01.78→	6	<b>0 432 221 865</b>

**ISUZU**

<b>Elf</b>						
<b>NPR 115 3.2</b>	3,2	101	4BD1-T	10.97→	4	<b>9 430 613 298</b>
<b>FSR</b>						
<b>5.8 D Turbo</b>	5,8	132	6BD1T	04.86-10.88	6	<b>9 430 610 024</b>
<b>FTR</b>						
<b>5.8 D Turbo</b>	5,8	132	6BD1T	04.86-12.90	6	<b>9 430 610 024</b>
<b>Serie F</b>						
<b>FTM1200T 7.1</b>	7,1	169	6HE1-TC	05.99→	6	<b>9 430 615 401</b>
<b>FTR32MT 7.1</b>	7,1	169	6HE1-TC	05.99→	6	<b>9 430 610 534</b>
<b>FTR800 8.2</b>	8,2	129	6HH1-N	05.99→	6	<b>9 430 610 534</b>
		147	6HH1-S	05.99→	6	<b>9 430 610 534</b>





◀ ISUZU











<b>FVR900T</b> 9.8	9,8	199	6SD1TC-N	05.99→	6	<b>9 430 611 665</b>
<b>FVR2300</b> 9.8	9,8	199	6SD1TC-N	05.99→	6	<b>9 430 611 665</b>
<b>FBZ1400T</b> 9.8	9,8	199	6SD1TC-N	05.99→	6	<b>9 430 611 665</b>
					6	<b>9 430 615 296</b>
<b>Serie N</b>						
<b>NKR</b> 3.3 D	3,3	65	4BC2	02.86-12.96	4	<b>9 430 610 026</b>
<b>NPR</b> 3.9 D	3,9	78	4BD1	01.81-12.91	4	<b>9 430 610 023</b>
<b>NPR66L</b> 4.3	4,3	78	4HF1	09.99-12.06	4	<b>9 430 610 152</b>
<b>NPR66P</b> 4.3	4,3	78	4HF1	09.99-12.06	4	<b>9 430 610 152</b>
<b>NPR300</b> 4.3	4,3	78	4HF1	09.99-12.06	4	<b>9 430 610 152</b>
<b>NQR70R</b> 4.8	4,8	104	4HE1-T	09.99-12.06	4	<b>9 430 615 309</b>
<b>NQR75P</b> 5.2	5,2	110	4HK1 <Euro 3>	07.06→	4	<b>9 430 613 635</b>
<b>N100P</b> 4.3	4,3	78	4HF1-S	02.06-12.08	4	<b>9 430 610 152</b>
<b>N250T</b> 2.8 Carrier	2,8	67	4JB1-T	09.99-12.07	4	<b>9 430 613 958</b>
<b>TL, TLD</b>						
<b>2.8 D</b>	2,8	55	4BA1	01.75-02.86	4	<b>9 430 610 013</b>
<b>WFR, WFS</b>						
<b>2.0 D Turbo</b>	2,0	52	4FC1T	05.86-12.96	4	<b>9 430 610 009</b>
<b>2.2 D</b>	2,2	45	4FD1	02.83-12.96	4	<b>9 430 610 028</b>

**IVECO**

<b>A</b>						
<b>55</b> -10	4,6	73	OM-8340.04.300	05.82-07.87	4	<b>0 432 281 710</b>
-13	5,5	99	8060.04.658	12.79-12.88	6	<b>0 432 281 718</b>
-14	5,9	101	8060.05.246	12.88-12.91	6	<b>0 432 291 648</b>
<b>60</b> -10	4,6	73	OM-8340.04.040	11.79-06.88	4	<b>0 432 281 710</b>
<b>70</b> -14	5,9	101	8060.05.246	05.88-06.91	6	<b>0 432 291 648</b>
<b>79</b> -14	5,9	102	8060.05.285	07.88-12.92	6	<b>0 432 291 648</b>
<b>90</b> -14	5,9	101	8060.05.246	05.88-06.91	6	<b>0 432 291 648</b>
<b>Daily</b>						
<b>A40</b> -8	2,5	55	8140.07.27...	07.89-04.96	4	<b>0 432 191 728</b>
-10 Turbo	2,5	76	8140.27S.37...	09.89-04.96	4	<b>0 432 193 845 0 986 430 256</b>
-10 Turbo, -12 Turbo	2,8	76/90	8140.23.37... <Euro 2>; 8140.43.37... <Euro 2>; 8140.43.3723 <Euro 2>	05.96-05.99	4	<b>0 432 193 757 0 986 430 522</b>
<b>A45</b> -10 Turbo	2,5	76	8140.27S.27...			
			Mot.Nr. →1448379	07.89-06.91	4	<b>0 432 191 760</b>
			Mot.Nr. 1448380→	07.91-04.96	4	<b>0 432 191 725</b>
			8140.27S.37...	09.89-04.96	4	<b>0 432 193 845 0 986 430 256</b>
-10 Turbo, -12 Turbo [96]	2,8	76/90	8140.23.3721 <Euro 2>; 8140.43.37... <Euro 2>; 8140.43.3723 <Euro 2>	05.96-05.99	4	<b>0 432 193 757 0 986 430 522</b>
-12 Turbo	2,5	85	8140.47S.2785; 8140.47.37...	06.90-04.96	4	<b>0 432 193 845 0 986 430 256</b>
			8140.47.27...	06.90-04.96	4	<b>0 432 191 729</b>
<b>A49</b> -10 Turbo [96]	2,8	76	8140.23.37... <Euro 2>	05.96-05.99	4	<b>0 432 193 757 0 986 430 522</b>
<b>29 L9</b> [00]	2,8	62	8140.63.4000	05.99-12.01	4	<b>0 432 117 002</b>
11 [00]	2,8	78	8140.43C...	05.99-09.02	4	<b>0 432 193 757 0 986 430 522</b>
<b>30</b> -8	2,5	55	8140.07.27...	02.91-04.96	4	<b>0 432 191 728</b>
			8140.07.371...	02.91-04.96 BO	4	<b>0 432 193 818</b>
-8 [96]	2,5	60	8140.67F.37... <Euro 2>	05.96-03.98	4	<b>0 432 297 057 0 986 430 532</b>
	2,8	62	8140.63.37... <Euro 2>	04.98-05.99	4	<b>0 432 117 002</b>
-10 Turbo [96]	2,8	76	8140.23.37... <Euro 2>; 8140.23.3713 <Euro 2>	05.96-05.99	4	<b>0 432 193 757 0 986 430 522</b>
<b>35</b> -8	2,5	55	8140.07.27...	02.91-04.96	4	<b>0 432 191 728</b>
			8140.07.37...	02.91-04.96 BO	4	<b>0 432 193 818</b>
-8 [96]	2,5	60	8140.67F.37... <Euro 2>	05.96-03.98	4	<b>0 432 297 057 0 986 430 532</b>
	2,8	62	8140.63.37... <Euro 2>	04.98-05.99	4	<b>0 432 117 002</b>
-10 Turbo	2,5	66,1-68,9	8140.97.27...	07.91-04.96	4	<b>0 432 297 055</b>
		76	8140.27S.37...	09.89-04.96	4	<b>0 432 193 845 0 986 430 256</b>
		77,5-83	8140.47B.37...	01.93-05.96	4	<b>0 432 193 843</b>
-10 Turbo [96]	2,5	80	8140.47R...	07.92-04.97	4	<b>0 432 193 843</b>
-10 Turbo I.D.	2,5	80	8140.47R.2790	07.92-04.97	4	<b>0 432 193 842 1</b>
					4	<b>0 432 193 843</b>





										
<b>35</b> -10 Turbo, -12 Turbo [96]	2,8	76/90	8140.23.37... <Euro 2>; 8140.23.3713 <Euro 2>; 8140.43.37... <Euro 2>; 8140.43.39... <Euro 2>		05.96-05.99			4	<b>0 432 193 757</b>	<b>0 986 430 522</b>
-12 Turbo	2,5	85	8140.47S.2785; 8140.47.37... 8140.47.27...		10.90-04.96 10.90-04.96			4	<b>0 432 193 845</b>	<b>0 986 430 256</b>
.10, .12	2,8	76/90	8140.23 <ID/TCA>; 8140.43 <ID/TCA>		11.97-07.07			4	<b>0 432 193 757</b>	<b>0 986 430 522</b>
<b>35 C</b> 9 [00]	2,8	62	8140.63.40...		05.99-12.01			4	<b>0 432 117 002</b>	
11 [00]	2,8	78	8140.43C...		05.99-09.02			4	<b>0 432 193 757</b>	<b>0 986 430 522</b>
<b>35 S</b> 9 [00]	2,8	62	8140.63.40...		05.99-12.01			4	<b>0 432 117 002</b>	
11 [00]	2,8	78	8140.43C...		05.99-03.02			4	<b>0 432 193 757</b>	<b>0 986 430 522</b>
<b>40</b> -8	2,5	55	8140.07.27... 8140.07.37...		07.89-04.96 07.89-04.96 BO			4	<b>0 432 191 728</b>	
-10 Turbo 4x4	2,5	76	8140.27S.28... Mot.Nr. →1448379 Mot.Nr. 1448380→ 8140.27S.3811		09.89-06.91 07.91-04.96 09.89-04.96			4	<b>0 432 191 760</b>	
-10 Turbo 4x4 [96]	2,8	76	8140.23.3801 <Euro 2>		05.96-05.99			4	<b>0 432 193 757</b>	<b>0 986 430 522</b>
.10	2,5	76	8140.27S		11.97-12.01			4	<b>0 432 193 757</b>	<b>0 986 430 522</b>
.12	2,8	76	8140.43		11.97-07.07			4	<b>0 432 193 757</b>	<b>0 986 430 522</b>
<b>45</b> -10 Turbo	2,5	76	8140.27S.37...		09.89-04.96			4	<b>0 432 193 845</b>	<b>0 986 430 256</b>
<b>49</b> -10 Turbo	2,5	76	8140.27S.37...		09.89-04.96			4	<b>0 432 193 845</b>	<b>0 986 430 256</b>
-10 Turbo, -12 Turbo [96]	2,8	76/90	8140.23.37... <Euro 2>; 8140.23.3713 <Euro 2>; 8140.43.37... <Euro 2>		05.96-05.99			4	<b>0 432 193 757</b>	<b>0 986 430 522</b>
-10, -10 Turbo	2,5	77,5-83	8140.47B.37...; 8140.47R.27...		07.92-04.97			4	<b>0 432 193 843</b>	
-12 Turbo	2,5	85	8140.47S.2785; 8140.47.37... 8140.47.27...		06.90-04.96 06.90-04.96			4	<b>0 432 193 845</b>	<b>0 986 430 256</b>
.12	2,8	90	8140.43		11.97-07.07			4	<b>0 432 193 757</b>	<b>0 986 430 522</b>
<b>50 C</b> 11 [00]	2,8	78	8140.43C...		05.99-09.02			4	<b>0 432 193 757</b>	<b>0 986 430 522</b>
<b>59</b> -12 Turbo	2,5	85	8140.47S.2785 8140.47.27... 8140.47.37...		10.90-04.96 05.91-04.96 05.91-04.96			4	<b>0 432 193 845</b>	<b>0 986 430 256</b>
-12 Turbo [96]	2,8	90	8140.43.37... <Euro 2>		05.96-05.99			4	<b>0 432 193 757</b>	<b>0 986 430 522</b>
.12	2,8	76	8140.43		11.97-07.07			4	<b>0 432 193 757</b>	<b>0 986 430 522</b>
<b>60</b> .12	2,8	90	8140.43		10.02-07.07			4	<b>0 432 193 757</b>	<b>0 986 430 522</b>
<b>Daily, Grinta</b>										
<b>30</b> -8	2,4	53	8140.61.2...		04.78-06.89			4	<b>0 432 297 034</b>	<b>0 986 430 144</b>
-10 Turbo	2,5	76,5	8140.27S.3...		02.85-06.89			4	<b>0 432 193 845</b>	<b>0 986 430 256</b>
<b>35</b> -8	2,4	53	8140.61.2...		04.78-06.89			4	<b>0 432 297 034</b>	<b>0 986 430 144</b>
-8 Duty	2,5	55	8140.07.27...		07.89-06.90			4	<b>0 432 191 728</b>	
-10 Turbo	2,4	67	8140.21.2...		02.85-06.89			4	<b>0 432 191 829</b>	
	2,5	62	8140.27S.37... 70 8140.27R.27...		02.85-06.89 05.85-09.90			4	<b>0 432 193 845</b>	<b>0 986 430 256</b>
<b>40</b> -8	2,4	53	8140.61.2...		01.83-06.89			4	<b>0 432 297 034</b>	<b>0 986 430 144</b>
-10 Turbo 4x4	2,5	76	8140.27.2...		02.85-06.89			4	<b>0 432 191 829</b>	
<b>45</b> -10 Turbo	2,4	67	8140.21.2...		02.85-06.89			4	<b>0 432 191 829</b>	
<b>49</b> -10 Turbo	2,4	67	8140.21.2...; 8140.21.290		02.85-06.89			4	<b>0 432 191 829</b>	
	2,5	70	8140.27R.27...		05.85-09.90			4	<b>0 432 193 876</b>	
<b>EuroCargo</b>										
<b>60 E</b> 10, 12	4,0	75/85	8040.25B.42...; 8040.25X.4...		01.91-05.96			4	<b>0 432 291 559</b>	
14	4,0	100	8040.45X.4180 8040.45.40... 8040.45.4303		01.91-05.96 01.91-05.96 01.91-05.96			4	<b>0 432 193 847</b>	
<b>65 E</b> 10, 12	4,0	75/85	8040.25B.42...; 8040.25X.40...; 8040.25X.49...		01.91-05.96			4	<b>0 432 291 559</b>	
12, 14	4,0	85/100	8040.45D...; 8040.45.5...		01.91-07.00			4	<b>0 432 193 798</b>	
14	4,0	100	8040.45.40... 8040.45.4303		01.91-06.96 01.91-06.96			4	<b>0 432 191 741</b>	
<b>75 E</b> 12	4,0	85	8040.25X.40...		01.91-05.96			4	<b>0 432 291 559</b>	
12, 14	4,0	85/100	8040.45D.51...; 8040.45.5...		01.93-08.00			4	<b>0 432 193 798</b>	
14	4,0	100	8040.45X.4180 TCA 8040.45.40... 8040.45.4303 TCA		01.92-12.92 01.91-12.93 01.92-05.96			4	<b>0 432 193 847</b>	
								4	<b>0 432 191 741</b>	
								4	<b>0 432 191 692</b>	





◀ IVECO

<b>75 E 15</b>	6,0	105	8060.25R.4...	01.91-12.92	6	<b>0 432 291 559</b>
			8060.45R.50...	01.93-08.00	6	<b>0 432 193 798</b>
<b>80 E 15</b>	6,0	105	8060.45R.50...	01.93-08.00	6	<b>0 432 193 798</b>
15, 18	6,0	105/130	8060.25R.42...; 8060.25V.40...	01.91-08.00	6	<b>0 432 291 559</b>
18	6,0	130	8060.45B.51...	09.91-07.00	6	<b>0 432 193 798</b>
21	6,0	152	8060.45X.4180	01.92-06.00	6	<b>0 432 193 847</b>
			8060.45.41...	01.91-08.00	6	<b>0 432 191 741</b>
			8060.45.4403	01.91-08.00	6	<b>0 432 191 692</b>
			8060.45.52...	01.91-08.00	6	<b>0 432 193 798</b>
<b>85 E 15, 18</b>	6,0	105/130	8060.25R.49...; 8060.25V.49...	01.91-08.00	6	<b>0 432 291 559</b>
18	6,0	130	8060.45B.43...	09.91-07.00	6	<b>0 432 191 692</b>
			8060.45B.51...	09.91-07.00	6	<b>0 432 193 798</b>
<b>90 E 15</b>	6,0	105	8060.25R.47...	01.83-12.94	6	<b>0 432 291 559</b>
15, 18	6,0	105/130	8060.45B.51...; 8060.45R.50...	09.91-08.00	6	<b>0 432 193 798</b>
18	6,0	130	8060.45B.43...	09.91-07.00	6	<b>0 432 191 692</b>
21	6,0	152	8060.45.47...	01.91-12.00	6	<b>0 432 191 741</b>
			8060.45.52...	01.91-08.00	6	<b>0 432 193 798</b>
<b>100 E 15</b>	6,0	105	8060.25R.42...	01.91-08.00	6	<b>0 432 291 559</b>
15, 21	6,0	105/152	8060.45R.50...; 8060.45.52...	01.91-08.00	6	<b>0 432 193 798</b>
18	6,0	130	8060.25V.40...	01.91-11.00	6	<b>0 432 291 559</b>
			8060.45B.51...	09.91-07.00	6	<b>0 432 193 798</b>
21	6,0	152	8060.45X.4180 TCA	01.92-11.00	6	<b>0 432 193 847</b>
			8060.45.41...	01.91-11.00	6	<b>0 432 191 741</b>
			8060.45.4403	01.91-08.00	6	<b>0 432 191 692</b>
<b>120 E 15</b>	6,0	105	8060.25R.4...	12.91-07.00	6	<b>0 432 291 559</b>
			8060.45R.50...	12.91-07.00	6	<b>0 432 193 798</b>
18	6,0	130	8060.25V.4...	09.91-07.00	6	<b>0 432 291 559</b>
18, 21	6,0	130/152	8060.45B.51...; 8060.45.52...	01.91-08.00	6	<b>0 432 193 798</b>
23	6,0	167	8060.45K.6090	02.92-07.00	6	<b>0 432 193 846</b>
			8060.45S.60...	CH 10.91-08.00	6	<b>0 432 193 846</b>
				GH 10.91-08.00	6	<b>0 432 191 732</b>
			8060.45S.72...	10.91-08.00	6	<b>0 432 193 730</b>
<b>130 E 15</b>	6,0	105	8060.25R.4...	02.92-07.00	6	<b>0 432 291 559</b>
			8060.45R.50...	12.91-07.00	6	<b>0 432 193 798</b>
18	6,0	130	8060.25V.4...	11.91-07.00	6	<b>0 432 291 559</b>
			8060.45B.51...	09.91-07.00	6	<b>0 432 193 798</b>
23	6,0	167	8060.45K.6090	11.91-07.00	6	<b>0 432 193 846</b>
			8060.45S.60...	CH 04.92-07.00	6	<b>0 432 193 846</b>
				GH 04.92-07.00	6	<b>0 432 191 732</b>
			8060.45S.72...	04.92-07.00	6	<b>0 432 193 730</b>
<b>135 E 18</b>	5,8	130	8060.25V.47...	01.94-07.00	6	<b>0 432 291 559</b>
			8060.45B.51...	01.94-07.00	6	<b>0 432 193 798</b>
23	5,8	167	8060.45S.67...	CH 01.94-07.00	6	<b>0 432 193 846</b>
				GH 01.94-07.00	6	<b>0 432 191 732</b>
			8060.45S.725...	01.94-07.00	6	<b>0 432 193 730</b>
<b>150 E 15</b>	6,0	105	8060.25R.4...	12.91-07.00	6	<b>0 432 291 559</b>
			8060.45R.50...	12.91-07.00	6	<b>0 432 193 798</b>
18	6,0	130	8060.25V.4...	09.91-07.00	6	<b>0 432 291 559</b>
18, 21	6,0	130/152	8060.45B.51...; 8060.45.52...	01.91-08.00	6	<b>0 432 193 798</b>
23	6,0	167	8060.45K.6090	02.92-07.00	6	<b>0 432 193 846</b>
			8060.45S.6...	CH 10.91-07.00	6	<b>0 432 193 846</b>
				GH 10.91-07.00	6	<b>0 432 191 732</b>
			8060.45S.720...	10.91-07.00	6	<b>0 432 193 730</b>
27	7,7	196	8360.46...<Euro1	09.91-07.00	6	<b>0 432 291 554</b>
			8360.46...<Euro2	09.91-07.00	6	<b>0 432 291 514</b>
<b>170 E 15</b>	6,0	105	8060.25R.436...	12.91-07.00	6	<b>0 432 291 559</b>
18	5,8	130	8060.25V.41...	01.94-07.00	6	<b>0 432 291 559</b>
			8060.45B.51...	09.91-07.00	6	<b>0 432 193 798</b>
23	5,8	167	8060.45S.6...	CH 01.94-07.00	6	<b>0 432 193 846</b>
				GH 01.94-07.00	6	<b>0 432 191 732</b>
			8060.45S.72...	01.94-07.00	6	<b>0 432 193 730</b>
27	7,7	196	8360.46...<Euro2>	09.91-07.00	6	<b>0 432 291 514</b>





<b>180 E 21</b>	6,0	152	8060.45.41...		04.92-07.00	6	<b>0 432 191 741</b>
			8060.45.4403		04.92-07.00	6	<b>0 432 191 692</b>
			8060.45.52...		04.92-07.00	6	<b>0 432 193 798</b>
<b>260 E 23</b>	6,0	167	8060.45S.6...	CH	12.91-07.00	6	<b>0 432 193 846</b>
				CH	12.91-07.00	6	<b>0 432 191 732</b>
			8060.45S.7...		12.91-07.00	6	<b>0 432 193 730</b>
27	7,7	196	8360.46...<Euro1>		09.91-07.00	6	<b>0 432 291 554</b>
			8360.46...<Euro2>		07.92-07.00	6	<b>0 432 291 514</b>
<b>280 E 23</b>	6,0	167	8060.45S.6... <Euro1>	CH	12.91-11.00	6	<b>0 432 193 846</b>
				CH	12.91-11.00	6	<b>0 432 191 732</b>
			8060.45S.7... <Euro2>		12.91-11.00	6	<b>0 432 193 730</b>
<b>320 E 27</b>	7,7	196	8360.46... <Euro1>		10.91-08.00	6	<b>0 432 291 554</b>
			8360.46... <Euro2>		10.91-08.00	6	<b>0 432 291 514</b>
<b>EuroClass</b>							
<b>380 12.38</b>	9,5	278	8460.41 M <Euro I, EDC>		01.93-11.02	6	<b>0 432 191 679</b>
<b>EuroStar</b>							
<b>180 E 38</b>	9,5	276	8460.41N.6...		09.92-07.00	6	<b>0 432 193 641</b>
42	14,0	309	8210.42L.4620 -Euro2		04.92-07.00	6	<b>0 432 291 516</b>
<b>190 E 38</b>	9,5	276	8460.41L.5... <Euro1>				
			Mot.Nr. →33841		06.92-07.00 BO	6	<b>0 432 191 731</b>
			Mot.Nr. 33842→406951		06.92-07.00	6	<b>0 432 191 679</b>
			Mot.Nr. 406952→		06.92-07.00	6	<b>0 432 191 646</b>
			8460.41N.6... <Euro2>		09.92-07.00	6	<b>0 432 193 641</b>
42	14,0	309	8210.42L.4... <Euro1>		04.92-07.00	6	<b>0 432 291 555</b>
		345	8210.42L.4... <Euro2>		04.92-11.00	6	<b>0 432 291 516</b>
47	14,0	345	8210.42M.5... <Euro 2>		04.92-11.00	6	<b>0 432 291 519</b>
52	17,2	378	8280.42S.3...		04.92-11.00	8	<b>0 432 291 549</b>
<b>240 E 38</b>	9,5	276	8460.41L.5...				
			Mot.Nr. →33841		09.92-11.00 BO	6	<b>0 432 191 731</b>
			Mot.Nr. 33842→406951		09.92-11.00	6	<b>0 432 191 679</b>
			Mot.Nr. 406952→		09.92-11.00	6	<b>0 432 191 646</b>
			8460.41N.6...		09.92-11.00	6	<b>0 432 193 641</b>
42	14,0	309	8210.42L.4... <Euro1>		04.92-12.00	6	<b>0 432 291 555</b>
			8210.42L.4...<Euro2>		04.92-12.00	6	<b>0 432 291 516</b>
47	14,0	345	8210.42M... <Euro 2>		11.95-12.02	6	<b>0 432 291 519</b>
52	17,2	378	8280.42S.3... <Euro 2>		04.92-12.00	8	<b>0 432 291 549</b>
<b>260 E 38</b>	9,5	276	8460.41L.5... <Euro1>				
			Mot.Nr. →33841		06.92-09.95 BO	6	<b>0 432 191 731</b>
			Mot.Nr. 33842→406951		06.92-09.95	6	<b>0 432 191 679</b>
			Mot.Nr. 406952→		06.92-09.95	6	<b>0 432 191 646</b>
42	14,0	309	8210.42L.4... <Euro2>		06.92-12.00	6	<b>0 432 291 516</b>
47	14,0	345	8210.42M.5... <Euro 2>		06.92-12.00	6	<b>0 432 291 519</b>
<b>400 E 38</b>	9,5	276	8460.41L.5...<Euro1>				
			Mot.Nr. →33841		09.92-11.00 BO	6	<b>0 432 191 731</b>
			Mot.Nr. 33842→406951		09.92-11.00	6	<b>0 432 191 679</b>
			Mot.Nr. 406952→		09.92-11.00	6	<b>0 432 191 646</b>
			8460.41N.6... <Euro2>		09.92-11.00	6	<b>0 432 193 641</b>
42	14,0	309	8210.42L.4... <Euro1>		04.92-12.00	6	<b>0 432 291 555</b>
			8210.42L.4...<Euro2>		04.92-12.00	6	<b>0 432 291 516</b>
47	14,0	345	8210.42M.5... <Euro2>		04.92-11.00	6	<b>0 432 291 519</b>
52	17,2	378	8280.42S.3...		04.92-12.00	8	<b>0 432 291 549</b>
<b>440 E 38</b>	9,5	276	8460.41L.5... <Euro1>				
			Mot.Nr. →33841		04.93-11.00 BO	6	<b>0 432 191 731</b>
			Mot.Nr. 33842→406951		04.93-11.00	6	<b>0 432 191 679</b>
			Mot.Nr. 406952→		04.93-11.00	6	<b>0 432 191 646</b>
			8460.41N.6...<Euro2>		04.93-11.00	6	<b>0 432 193 641</b>
42	14,0	309	8210.42L.4... <Euro1>		04.92-12.00	6	<b>0 432 291 555</b>
47	13,8	345	8210.42M.5... <Euro2>		04.92-12.00	6	<b>0 432 291 519</b>
52	17,2	378	8280.42S.3... <Euro I>		04.92-12.00	8	<b>0 432 291 549</b>
<b>EuroTech</b>							
<b>175 E 27</b>	7,7	196	OM-8360.46.417 TCA		04.92-07.00	6	<b>0 432 291 554</b>
<b>179 E 27</b>	7,7	196	8360.46.417 TCA		04.92-07.00	6	<b>0 432 291 554</b>





◀ IVECO

<b>180 E 24, 27</b>	7,7	176/196	8360.46... <Euro1>; 8360.46R... <Euro1>	07.92-07.00	6	<b>0 432 291 554</b>
			8360.46... <Euro2>; 8360.46R... <Euro2>	07.92-07.00	6	<b>0 432 291 514</b>
30	9,5	221	8460.41C.3... <Euro1>			
			Mot.Nr. →33870	07.92-07.00	6	<b>0 432 191 731</b>
			Mot.Nr. 33871→406951	07.92-07.00	6	<b>0 432 191 679</b>
			Mot.Nr. 406952→	07.92-07.00	6	<b>0 432 191 646</b>
30, 34	9,5	221/254	8460.41C.30... <Euro2>; 8460.41K.4... <Euro2>	04.92-07.00	6	<b>0 432 193 792</b>
34	9,5	254	8460.41K.4... <Euro1>			
			Mot.Nr. →33841	04.92-07.00	6	<b>0 432 191 731</b>
			Mot.Nr. 33842→406951	04.92-07.00	6	<b>0 432 191 679</b>
			Mot.Nr. 406952→	04.92-07.00	6	<b>0 432 191 646</b>
38	9,5	276	8460.41L.5... <Euro1>			
			Mot.Nr. →33841	09.92-07.00 BO	6	<b>0 432 191 731</b>
			Mot.Nr. 33842→406951	09.92-07.00	6	<b>0 432 191 679</b>
			Mot.Nr. 406952→	09.92-07.00	6	<b>0 432 191 646</b>
			8460.41N.6...	09.92-07.00	6	<b>0 432 193 641</b>
42	14,0	309	8210.42L.4... <Euro1>	04.92-07.00	6	<b>0 432 291 555</b>
52	17,2	378	8280.42S.350	04.92-07.00	8	<b>0 432 291 549</b>
<b>190 E 24, 27</b>	7,7	176/196	8360.46... <Euro1>; 8360.46R... <Euro1>	07.92-07.00	6	<b>0 432 291 554</b>
			8360.46... <Euro2>; 8360.46R... <Euro2>	07.92-07.00	6	<b>0 432 291 514</b>
30	9,5	221	8460.41C.3... <Euro1>			
			Mot.Nr. →33870	07.92-07.00	6	<b>0 432 191 731</b>
			Mot.Nr. 33871→406951	07.92-07.00	6	<b>0 432 191 679</b>
			Mot.Nr. 406952→	07.92-07.00	6	<b>0 432 191 646</b>
30, 34	9,5	221/254	8460.41C.30... <Euro2>; 8460.41K.4... <Euro2>	04.92-07.00	6	<b>0 432 193 792</b>
34	9,5	254	8460.41K.4... <Euro1>			
			Mot.Nr. →33841	04.92-07.00	6	<b>0 432 191 731</b>
			Mot.Nr. 33842→406951	04.92-07.00	6	<b>0 432 191 679</b>
			Mot.Nr. 406952→	04.92-07.00	6	<b>0 432 191 646</b>
38	9,5	276	8460.41L.5... <Euro1>			
			Mot.Nr. →33841	06.92-07.00 BO	6	<b>0 432 191 731</b>
			Mot.Nr. 33842→406951	06.92-07.00	6	<b>0 432 191 679</b>
			Mot.Nr. 406952→	06.92-07.00	6	<b>0 432 191 646</b>
			8460.41L.6... <Euro2>; 8460.41N.6... <Euro2>	09.92-07.00	6	<b>0 432 193 641</b>
42	14,0	309	8210.42L.4... <Euro1>	04.92-07.00	6	<b>0 432 291 555</b>
		345	8210.42L.4... <Euro2>	04.92-11.00	6	<b>0 432 291 516</b>
<b>240 E 25, 30, 34</b>	9,5	185/221/254	8460.41C.3032-Euro2; 8460.41K.4... <Euro2>; 8460.41T.2036	09.95-12.02	6	<b>0 432 193 792</b>
30	9,5	221	8460.41C.3... <Euro1>			
			Mot.Nr. →33870	09.96-12.02	6	<b>0 432 191 731</b>
			Mot.Nr. 33871→406951	09.96-12.02	6	<b>0 432 191 679</b>
			Mot.Nr. 406952→	09.96-12.02	6	<b>0 432 191 646</b>
34	9,5	254	8460.41K.4... <Euro1>			
			Mot.Nr. →33841	09.95-12.02	6	<b>0 432 191 731</b>
			Mot.Nr. 33842→406951	09.95-12.02	6	<b>0 432 191 679</b>
			Mot.Nr. 406952→	09.95-12.02	6	<b>0 432 191 646</b>
38	9,5	276	8460.41L.5...			
			Mot.Nr. →33841	09.92-11.00 BO	6	<b>0 432 191 731</b>
			Mot.Nr. 33842→406951	09.92-11.00	6	<b>0 432 191 679</b>
			Mot.Nr. 406952→	09.92-11.00	6	<b>0 432 191 646</b>
			8460.41N.6...	09.92-11.00	6	<b>0 432 193 641</b>
42	14,0	309	8210.42L.4... <Euro1>	04.92-12.00	6	<b>0 432 291 555</b>
			8210.42L.4... <Euro2>	04.92-12.00	6	<b>0 432 291 516</b>
<b>260 E 38</b>	9,5	276	8460.41L.5... Euro1			
			Mot.Nr. →33841	06.92-09.95 BO	6	<b>0 432 191 731</b>
			Mot.Nr. 33842→406951	06.92-09.95	6	<b>0 432 191 679</b>
			Mot.Nr. 406952→	06.92-09.95	6	<b>0 432 191 646</b>
			8460.41N.6... <Euro 2>	06.92-07.00	6	<b>0 432 193 641</b>
42	14,0	309	8210.42L.4... <Euro1>	06.92-12.00	6	<b>0 432 291 555</b>
			8210.42L.4... <Euro2>	06.92-12.00	6	<b>0 432 291 516</b>





<b>260 E 52</b>	17,2	378	8280.42S.3...	04.92-07.00	8	<b>0 432 291 549</b>
<b>325 E 27</b>	7,7	196	8360.46... <Euro1>	07.92-07.00	6	<b>0 432 291 554</b>
			8360.46... <Euro2>	07.92-07.00	6	<b>0 432 291 514</b>
<b>400 E 30</b>	9,5	221	8460.41C.3... <Euro1>			
			Mot.Nr. →33870	04.92-12.00	6	<b>0 432 191 731</b>
			Mot.Nr. 33871→406951	04.92-12.00	6	<b>0 432 191 679</b>
			Mot.Nr. 406952→	04.92-12.00	6	<b>0 432 191 646</b>
30, 34	9,5	221/254	8460.41C.30... <Euro2>; 8460.41K.4... <Euro2>	04.92-12.00	6	<b>0 432 193 792</b>
34	9,5	254	8460.41K.4... <Euro1>			
			Mot.Nr. →33841	04.92-12.00	6	<b>0 432 191 731</b>
			Mot.Nr. 33842→406951	04.92-12.00	6	<b>0 432 191 679</b>
			Mot.Nr. 406952→	04.92-12.00	6	<b>0 432 191 646</b>
38	9,5	276	8460.41L.5... <Euro1>			
			Mot.Nr. →33841	09.92-11.00 BO	6	<b>0 432 191 731</b>
			Mot.Nr. 33842→406951	09.92-11.00	6	<b>0 432 191 679</b>
			Mot.Nr. 406952→	09.92-11.00	6	<b>0 432 191 646</b>
			8460.41N.6...-Euro2	09.92-11.00	6	<b>0 432 193 641</b>
42	14,0	309	8210.42L.4... <Euro1>	04.92-12.00	6	<b>0 432 291 555</b>
			8210.42L.4... <Euro2>	04.92-12.00	6	<b>0 432 291 516</b>
52	17,2	378	8280.42S.3...	04.92-12.00	8	<b>0 432 291 549</b>
<b>440 E 34</b>	9,5	254	8460.41K.4... <Euro1>			
			Mot.Nr. →33841	04.92-07.00	6	<b>0 432 191 731</b>
			Mot.Nr. 33842→406951	04.92-07.00	6	<b>0 432 191 679</b>
			Mot.Nr. 406952→	04.92-07.00	6	<b>0 432 191 646</b>
			8460.41K.4... <Euro2>	04.92-07.00	6	<b>0 432 193 792</b>
38	9,5	276	8460.41L.5...-Euro1			
			Mot.Nr. →33841	04.93-11.00 BO	6	<b>0 432 191 731</b>
			Mot.Nr. 33842→406951	04.93-11.00	6	<b>0 432 191 679</b>
			Mot.Nr. 406952→	04.93-11.00	6	<b>0 432 191 646</b>
			8460.41N.6... <Euro2>	04.93-11.00	6	<b>0 432 193 641</b>
42	14,0	309	8210.42L.4... <Euro1>	04.92-12.00	6	<b>0 432 291 555</b>
			8210.42L.4... <Euro2>	04.92-12.00	6	<b>0 432 291 516</b>
<b>EuroTrakker</b>						
<b>180 E 25</b>	9,5	185	8460.41T...	04.97-11.00	6	<b>0 432 193 792</b>
<b>190 E 30</b>	9,5	221	8460.41C.3... <Euro1>			
			Mot.Nr. →33870	07.92-07.00	6	<b>0 432 191 731</b>
			Mot.Nr. 33871→406951	07.92-07.00	6	<b>0 432 191 679</b>
			Mot.Nr. 406952→	07.92-07.00	6	<b>0 432 191 646</b>
30, 34	9,5	221/254	8460.41C.30... <Euro2>; 8460.41K.4...-Euro2	04.92-07.00	6	<b>0 432 193 792</b>
34	9,5	254	8460.41K.4...-Euro1			
			Mot.Nr. →33841	04.92-07.00	6	<b>0 432 191 731</b>
			Mot.Nr. 33842→406951	04.92-07.00	6	<b>0 432 191 679</b>
			Mot.Nr. 406952→	04.92-07.00	6	<b>0 432 191 646</b>
37	13,8	272	8210.42K... <Euro1>	04.93-11.00	6	<b>0 432 291 555</b>
			8210.42K... <Euro2>	04.93-11.00	6	<b>0 432 291 516</b>
42	14,0	309	8210.42L.4... <Euro1>	04.92-07.00	6	<b>0 432 291 555</b>
		345	8210.42L.4... <Euro2>	04.92-11.00	6	<b>0 432 291 516</b>
<b>260 E 30</b>	9,5	221	8460.41C.3... <Euro1>			
			Mot.Nr. →33870	07.92-07.00	6	<b>0 432 191 731</b>
			Mot.Nr. 33871→406951	07.92-07.00	6	<b>0 432 191 679</b>
			Mot.Nr. 406952→	07.92-07.00	6	<b>0 432 191 646</b>
30, 34	9,5	221/254	8460.41C.30... <Euro2>; 8460.41K.4... <Euro2>	04.92-07.00	6	<b>0 432 193 792</b>
34	9,5	254	8460.41K.4... <Euro1>			
			Mot.Nr. →33841	04.92-07.00	6	<b>0 432 191 731</b>
			Mot.Nr. 33842→406951	04.92-07.00	6	<b>0 432 191 679</b>
			Mot.Nr. 406952→	04.92-07.00	6	<b>0 432 191 646</b>
37	9,5	272	8210.42K.3... <Euro1>	12.94-12.01	6	<b>0 432 291 555</b>
			8210.42K.3... <Euro2>	12.94-12.01	6	<b>0 432 291 516</b>
42	14,0	309	8210.42L.4... <Euro1>	06.92-12.00	6	<b>0 432 291 555</b>
			8210.42L.4... <Euro2>	06.92-12.00	6	<b>0 432 291 516</b>





◀ IVECO

<b>260 E 47</b>	14,0	345	8210.42M.5... <Euro 2>	06.92-12.00	6	<b>0 432 291 519</b>	
<b>330 E 34</b>	9,5	254	8460.41K.4... <Euro1>				
			Mot.Nr. →33841	04.92-07.00	6	<b>0 432 191 731</b>	
			Mot.Nr. 33842→406951	04.92-07.00	6	<b>0 432 191 679</b>	
			Mot.Nr. 406952→	04.92-07.00	6	<b>0 432 191 646</b>	
37	13,8	272	8210.42K.3... <Euro1>	04.93-11.00	6	<b>0 432 291 555</b>	
<b>340 E 34</b>	9,5	254	8460.41K.4... <Euro1>				
			Mot.Nr. →33841	04.92-07.00	6	<b>0 432 191 731</b>	
			Mot.Nr. 33842→406951	04.92-07.00	6	<b>0 432 191 679</b>	
			Mot.Nr. 406952→	04.92-07.00	6	<b>0 432 191 646</b>	
			8460.41K.4... <Euro2>	04.92-07.00	6	<b>0 432 193 792</b>	
37	13,8	272	8210.42K.3... <Euro1>	03.95-12.02	6	<b>0 432 291 555</b>	
			8210.42K.3... <Euro2>	03.95-12.02	6	<b>0 432 291 516</b>	
42	14,0	309	8210.42L.4... <Euro1>	06.92-12.00	6	<b>0 432 291 555</b>	
			8210.42L.4... <Euro2>	06.92-12.00	6	<b>0 432 291 516</b>	
<b>380 E 34</b>	9,5	254	8460.41K.4... <Euro1>				
			Mot.Nr. →33841	04.92-07.00	6	<b>0 432 191 731</b>	
			Mot.Nr. 33842→406951	04.92-07.00	6	<b>0 432 191 679</b>	
			Mot.Nr. 406952→	04.92-07.00	6	<b>0 432 191 646</b>	
			8460.41K.4... <Euro2>	04.92-07.00	6	<b>0 432 193 792</b>	
37	13,8	272	8210.42K... <Euro1>	03.95-12.02	6	<b>0 432 291 555</b>	
			8210.42K.3... <Euro2>	03.95-12.02	6	<b>0 432 291 516</b>	
42	14,0	309	8210.42L... <Euro1>	06.92-12.00	6	<b>0 432 291 555</b>	
			8210.42L.4... <Euro2>	06.92-12.00	6	<b>0 432 291 516</b>	
47	14,0	345	8210.42M.5... <Euro 2>	06.92-12.00	6	<b>0 432 291 519</b>	
<b>400 E 34</b>	9,5	254	8460.41K.4... Euro1				
			Mot.Nr. →33841	04.92-12.00	6	<b>0 432 191 731</b>	
			Mot.Nr. 33842→406951	04.92-12.00	6	<b>0 432 191 679</b>	
			Mot.Nr. 406952→	04.92-12.00	6	<b>0 432 191 646</b>	
			8460.41K.4... Euro2	04.92-12.00	6	<b>0 432 193 792</b>	
37	13,8	272	8210.42K... <Euro1>	07.94-12.00	6	<b>0 432 291 555</b>	
			8210.42K.3... <Euro2>	07.94-12.00	6	<b>0 432 291 516</b>	
42	14,0	309	8210.42L.4... <Euro1>	04.92-12.00	6	<b>0 432 291 555</b>	
			8210.42L.4... <Euro2>	04.92-12.00	6	<b>0 432 291 516</b>	
<b>410 E 37, 42</b>	14,0	272/309	8210.42K.3... <Euro1>; 8210.42L.4... <Euro1>	04.92-11.00	6	<b>0 432 291 555</b>	
			8210.42K.3... <Euro2>; 8210.42L.4... <Euro2>	04.92-11.00	6	<b>0 432 291 516</b>	
<b>440 E 34</b>	9,5	254	8460.41K.4... Euro1				
			Mot.Nr. →33841	04.92-07.00	6	<b>0 432 191 731</b>	
			Mot.Nr. 33842→406951	04.92-07.00	6	<b>0 432 191 679</b>	
			Mot.Nr. 406952→	04.92-07.00	6	<b>0 432 191 646</b>	
			8460.41K.4... Euro2	04.92-07.00	6	<b>0 432 193 792</b>	
37	14,0	272	8210.42K.3... <Euro1>	04.92-11.00	6	<b>0 432 291 555</b>	
			8210.42K.3... <Euro2>	04.92-11.00	6	<b>0 432 291 516</b>	
42	14,0	309	8210.42L.4... <Euro1>	04.92-12.00	6	<b>0 432 291 555</b>	
			8210.42L.4... <Euro2>	04.92-12.00	6	<b>0 432 291 516</b>	
<b>720 E 37</b>	13,8	272	8210.42K... <Euro1>	09.93-12.95	6	<b>0 432 291 555</b>	
			8210.42K... <Euro2>	09.93-12.95	6	<b>0 432 291 516</b>	
42	13,8	309	8210.42L... <Euro1>	09.93-12.00	6	<b>0 432 291 555</b>	
			8210.42L.4... <Euro2>	09.93-12.00	6	<b>0 432 291 516</b>	
47	13,8	345	8210.42M.5... <Euro2>	04.92-12.00	6	<b>0 432 291 519</b>	
<b>Lorraine</b>							
<b>240 CS II, LS II</b>	9,5	177	8460.21.708	01.88-09.88	6	<b>0 432 191 818</b>	
<b>Scudato</b>							
<b>35 .10</b>	2,8	76	8140.23 <ID/TCA>	01.99-12.03	4	<b>0 432 193 757</b>	<b>0 986 430 522</b>
<b>49 .12</b>	2,8	76	8140.43	11.99-05.02	4	<b>0 432 193 757</b>	<b>0 986 430 522</b>
<b>59 .12</b>	2,8	76	8140.43	06.02-09.05	4	<b>0 432 193 757</b>	<b>0 986 430 522</b>
<b>60 .12</b>	2,8	90	8140.43	10.02-09.03	4	<b>0 432 193 757</b>	<b>0 986 430 522</b>
<b>TurboStar</b>							
<b>190 -36, -38 PT</b>	13,8	277	8210.42...; 8210.42.074; 8210.42.1...	07.90-11.00	6	<b>0 432 291 580</b>	
-48, -48, P	17,2	350/353	8280.42...; 8280.42.050	03.89-11.00	8	<b>0 432 291 595</b>	





<b>240</b> -36, -36 P	13,8	265-277	8210.42.07...; 8210.42.154	07.87-12.95	6	<b>0 432 291 580</b>	
-48	17,2	350	8280.42...; 8280.42.050 <Euro1>	03.89-11.99	8	<b>0 432 291 595</b>	
<b>260</b> -36	13,8	277	8210.42.1...	07.90-12.00	6	<b>0 432 291 580</b>	
-48	17,2	350	8280.42...	06.89-11.99	8	<b>0 432 291 595</b>	
<b>TurboTech</b>							
<b>190</b> -24	9,5	177	8460.21.2...	10.88-01.98	6	<b>0 432 191 766</b>	
-26	9,5	192	8460.21.10...	09.86-09.94	6	<b>0 432 191 818</b>	
-32	9,5	234	8460.41.1...	10.88-01.98	6	<b>0 432 191 763</b>	
		236	8460.41.16...	10.91-01.01	6	<b>0 432 191 731</b>	
-36, -36 T	13,8	277	8210.42.07...; 8210.42.1...	07.90-12.94	6	<b>0 432 291 580</b>	
<b>220</b> -32	9,5	234	8460.41.1...	03.89-11.99	6	<b>0 432 191 763</b>	
-36, -36 PT	13,8	265-277	8210.42.073; 8210.42.151	07.87-11.00	6	<b>0 432 291 580</b>	
<b>240</b> -26	9,5	192	8460.21.10...	07.90-11.00	6	<b>0 432 191 818</b>	
-32	9,5	234	8460.41.1...	03.89-11.98	6	<b>0 432 191 763</b>	
-36 P	13,8	277	8210.42.1...	07.90-12.95	6	<b>0 432 291 580</b>	
<b>260</b> -32	9,5	234	8460.41.1...	07.90-12.00	6	<b>0 432 191 763</b>	
-36	13,8	277	8210.42.073; 8210.42.151; 8210.42.155,175	07.90-12.99	6	<b>0 432 291 580</b>	
<b>40</b>							
<b>40</b> NC, NC 35	3,5	56	8040.02.267,367; 8040.02.300,360	01.73-12.90	4	<b>0 432 281 718</b>	
<b>49</b> NC	3,5	56	8040.02.267	01.73-12.90	4	<b>0 432 281 718</b>	
<b>50</b>							
<b>50</b> -8	3,7	63	8040.04.200	01.83-12.86	4	<b>0 432 281 718</b>	
<b>60</b>							
<b>60</b> -9 A	4,1	64	BF4L 913 T	11.85-04.88	4	<b>0 432 291 753 0 986 430 067</b>	
-10	4,6	74	OM-8340.04.200, 250	05.82-01.87	4	<b>0 432 281 710</b>	
-11	3,9	74	8040.25.230R	01.87-05.91	4	<b>0 432 291 654</b>	
<b>65</b> -10	4,6	74	OM-8340.04.3...	05.82-01.87	4	<b>0 432 281 710</b>	
-12	3,9	85	8040.25.2...	01.87-12.92	4	<b>0 432 291 654</b>	
<b>70</b>							
<b>75</b> -9 A...	4,1	64	BF4L 913 T; F4L 913	01.83-02.86	4	<b>0 432 291 753 0 986 430 067</b>	
-13 W	5,9	102	8060.05.270	07.87-12.92	6	<b>0 432 291 648</b>	
-14 PM	5,5	99	8060.04.070	01.83-03.86	6	<b>0 432 281 718</b>	
<b>79</b> -10	4,6	74	8340.04.200,300	01.83-01.87	4	<b>0 432 281 710</b>	
-12	3,9	85	8040.25.220	01.87-12.92	4	<b>0 432 291 654</b>	
-14	5,9	102	8060.05.28...	12.85-12.92	6	<b>0 432 291 648</b>	
<b>80</b>							
<b>80</b> -9 A..	4,1	64	F4L 913	01.83-02.86	4	<b>0 432 291 753 0 986 430 067</b>	
-13 A..	6,1	96	F6L 913	01.83-02.86	6	<b>0 432 291 753 0 986 430 067</b>	
		96-99	BF6L 913 T; BF6L 913 T Vollkaps.	01.83-12.91	6	<b>0 432 291 753 0 986 430 067</b>	
-14 W	5,9	102	8060.05.270	06.86-06.94	6	<b>0 432 291 648</b>	
-16 A..	6,1	118-124	BF6L 913	01.83-12.91	6	<b>0 432 291 752</b>	
<b>90</b>							
<b>90</b> -9 A..	4,1	64	F4L 913	01.83-02.86	4	<b>0 432 291 753 0 986 430 067</b>	
-13 A..	6,1	96-99	BF6L 913 T; F6L 913	01.83-12.91	6	<b>0 432 291 753 0 986 430 067</b>	
-17 W	5,5	125	8060.25.669,670	01.87-11.95	6	<b>0 432 291 655</b>	
<b>95</b> -14	5,9	102	8060.05.28...	11.85-05.91	6	<b>0 432 291 648</b>	
<b>100</b>							
<b>109</b> -14	5,9	102	8060.05.286,288,289	11.85-06.91	6	<b>0 432 291 648</b>	
<b>110</b>							
<b>110</b> NC, NR, NT, PC	5,2	90	8060.02.001,003	01.83-06.86	6	<b>0 432 281 718</b>	
-13 A...	6,1	96-99	BF6L 913 T	01.83-12.91	6	<b>0 432 291 753 0 986 430 067</b>	
			F6L 913	01.83-02.86	6	<b>0 432 291 753 0 986 430 067</b>	
-16 A...	6,1	118-124	BF6L 913	01.83-12.91	6	<b>0 432 291 752</b>	
-17 AW	6,1	124	BF6L 913	07.86-12.91	6	<b>0 432 191 798</b>	
<b>115</b> -14	5,9	99-102	8060.05.20...	11.85-12.91	6	<b>0 432 291 648</b>	
<b>120</b>							
<b>120</b> -13	6,1	96	F6L 913	01.83-02.86	6	<b>0 432 291 753 0 986 430 067</b>	
		96-99	BF6L 913 T	08.83-02.89	6	<b>0 432 291 753 0 986 430 067</b>	
				03.89-09.90	6	<b>0 432 291 669</b>	
-16	6,1	118	BF6L 913	01.83-11.89	6	<b>0 432 291 752</b>	
-17	6,1	124	BF6L 913/U	07.89-09.90	6	<b>0 432 291 752</b>	





◀ IVECO

<b>130</b>									
130-13 A...	6,1	96-99	BF6L 913 T; F6L 913		01.83-05.89	6	0 432 291 753	0 986 430 067	
-14	5,9	102	8060.05.20...		11.85-12.91	6	0 432 291 648		
-16 A...	6,1	118-124	BF6L 913		01.83-10.91	6	0 432 291 752		
-17	5,9	130	8060.25.6...		01.86-08.92	6	0 432 291 655		
<b>140</b>									
145-17	5,9	130	8060.25.60...		02.86-07.92	6	0 432 291 655		
<b>150</b>									
150-16 AN...	6,1	118	BF6L 913		01.83-12.91	6	0 432 291 752		
-18	10,0	132	F6L 413		09.83-02.86	6	0 432 291 807	0 986 430 124	
-23	12,8	168	F8L 413 F		02.84-02.86	8	0 432 291 807	0 986 430 124	
159-17	8,1	124	OM-8360.05.254		07.82-09.86	6	0 432 281 710		
<b>160</b>									
160-23 AHW, -23 ANW	12,8	168	F8L 413 F		04.84-05.89	8	0 432 291 807	0 986 430 124	
-30 AH...	12,8	225	BF8L 513		06.86-05.89	8	0 432 291 699		
160 R 81	6,1	107	BF6L 913		06.83-12.86	6	0 432 291 752		
165-24, T	9,6	177	8220.22.002,102		06.82-09.86	6	0 432 191 844		
<b>170</b>									
170-23 AHW	13,4	168-174	F8L 513		04.88-07.91	8	0 432 291 644		
175-17	5,9	130	8060.25.6...		09.86-07.92	6	0 432 291 655		
<b>180</b>									
180-24	9,6	177	8220.22.102		12.82-10.86	6	0 432 191 844		
-26	13,8	191	8210.02.371,373,393		06.82-10.86 CSA	6	0 432 281 732		
<b>190</b>									
190-24	9,6	177	8220.22.102		06.82-10.86	6	0 432 191 844		
-25 AH..., -25 AN...	12,8	188	F8L 413 F		07.83-09.90	8	0 432 291 807	0 986 430 124	
-30 AHW	12,8	225	BF8L 513		09.87-01.97	8	0 432 291 699		
<b>220</b>									
220-34 HTM	12,8	250	BF8L 513		09.91-11.00	8	0 432 291 699		
<b>240</b>									
240-25 ANW, -35 ANW	13,4	194	F8L 513		07.91-12.00	8	0 432 291 644		
-30 P	13,8	224	8210.22.269,327,385		07.80-04.89 CSA	6	0 432 281 732		
<b>260</b>									
260-23 AH, -25 AH...	13,4	168-174/ 194	F8L 513		04.89-12.99	8	0 432 291 644		
-23 AH, -25 AH..., -25 AN...	12,8	168/188	F8L 413 F		07.83-03.89	8	0 432 291 807	0 986 430 124	
-26 H..., -26 NW	13,8	191	8210.02.; 8210.02.067,731		01.77-02.86 CSA	6	0 432 281 732		
-30 AH..., -34 AH, -34 AHW	12,8	225/250	BF8L 513		06.86-12.99	8	0 432 291 699		
<b>300</b>									
300 PC, PT	13,8	191	8210.02.032,033,053		01.77-07.88 CSA	6	0 432 281 732		
-25 AH...	13,4	188	F8L 513		01.86-02.86	8	0 432 291 644		
-30 AH..., -32 AH..., -34 AH	12,8	225-232/ 243-250	BF8L 513		04.87-12.99	8	0 432 291 699		
<b>315</b>									
.8.17	5,5	123	8060.24.652		10.84-06.91	6	0 432 291 655		
.8.18	5,5	130	8060.25V.4600 8060.45B.5160		06.91-11.00 06.91-11.00	6 6	0 432 291 559 0 432 193 798		
<b>316</b>									
.8.13	5,5	92	8060.04.052		01.80-11.90	6	0 432 281 718		
.8.18	5,5	130	8060.45B.5160		06.91-11.00	6	0 432 193 798		
316.8.18	5,5	130	8060.25V.4600		06.91-11.00	6	0 432 291 559		
<b>320</b>									
320-32 AH...	12,8	232	BF8L 513		04.89-07.96	8	0 432 291 699		
<b>330</b>									
330-25 AN	12,8	188	F8L 413 F		04.89-12.89	8	0 432 291 807	0 986 430 124	
-30 AH, -30 AN...	12,8	225	BF8L 513		05.86-10.91	8	0 432 291 699		
-32 ANW	16,0	235	F10L 413 F		07.83-06.87	10	0 432 291 807	0 986 430 124	
-36 H	13,8	265	8210.42.009		10.91-12.99	6	0 432 291 580		
<b>340</b>									
-34 AH	12,8	250	BF8L 513		03.89-12.98	8	0 432 291 699		
<b>370</b>									
370.10.24, .12.24	9,6	177	8220.22.708,709; 8220.22.709		09.83-12.86	6	0 432 191 844		
370 S 24	9,6	177	8460.21.7...		01.87-11.98	6	0 432 191 818		
370 SE 27	7,7	196	8360.46.4370 8360.46.4637		07.92-07.00 07.92-07.00	6 6	0 432 291 514 0 432 291 554		







<b>370 SE 29</b>	9,5	214	8460.41.721				
			Mot.Nr. →33841	01.92-11.00	6	<b>0 432 191 731</b>	
			Mot.Nr. 33842→406951	01.92-11.00	6	<b>0 432 191 679</b>	
			Mot.Nr. 406952→	01.92-11.00	6	<b>0 432 191 646</b>	
<b>380</b>							
<b>380 .10.29, .12.29</b>	9,5	214	8460.41.721,723				
			Mot.Nr. →33841	01.92-11.00	6	<b>0 432 191 731</b>	
			Mot.Nr. 33842→406951	01.92-11.00	6	<b>0 432 191 679</b>	
			Mot.Nr. 406952→	01.92-11.00	6	<b>0 432 191 646</b>	
			8460.41.731,733				
			Mot.Nr. →33841	01.92-11.00	6	<b>0 432 191 731</b>	
			Mot.Nr. 33842→406951	01.92-11.00	6	<b>0 432 191 679</b>	
			Mot.Nr. 406952→	01.92-11.00	6	<b>0 432 191 646</b>	
<b>480</b>							
<b>.10.21 Turbocity-U</b>	9,5	155	8460.21.611 R	04.88-11.98	6	<b>0 432 191 766</b>	
<b>.12.21 Turbocity-U</b>	9,5	155	8460.21.611 R	04.88-11.98	6	<b>0 432 191 766</b>	
<b>580</b>							
<b>.10.21 Turbocity-S</b>	9,5	155	8460.21.611 R	10.88-11.98	6	<b>0 432 191 766</b>	
<b>.12.21 Turbocity-S</b>	9,5	155	8460.21.611 R	10.88-11.98	6	<b>0 432 191 766</b>	
<b>619</b>							
<b>N, T</b>	13,8	191	8210.02.032	01.70-07.88 CSA	6	<b>0 432 281 732</b>	
<b>670</b>							
<b>671 .12.24 I-Effeuno Turbo</b>	9,6	177	8220.32.723	09.83-12.88	6	<b>0 432 191 840</b>	
<b>680</b>							
<b>680 .12.26 Turbocity-I</b>	9,5	191	8460.21.601	06.89-11.98	6	<b>0 432 191 751</b>	
<b>3470</b>							
<b>3470 .18.24</b>	9,6	177	8220.32.701	01.82-12.86	6	<b>0 432 191 840</b>	
<b>3471 .18.24</b>	9,6	177	8220.32.721	01.85-12.88	6	<b>0 432 191 840</b>	

**KAMAZ**

<b>11t</b>							
<b>4308</b>	5,9	132	EQB180-20 <Euro 2>	01.00→	6	<b>0 432 133 837</b>	
		151	6BTA 5.9 <Euro 2>	01.00→	6	<b>F 000 439 019</b>	
<b>33t</b>							
<b>65226</b>	15,9	400	BF 8 M 1015 C <Euro 2>	01.00→	8	<b>0 432 131 795</b>	

**KÄSSBOHRER**

<b>Setra</b>							
<b>S 210 H..</b>	11,0	159	OM 421.900	10.83-06.96	6	<b>0 432 231 680</b>	<b>0 986 430 038</b>
		184	OM 421 A	09.85-12.92	6	<b>0 432 231 814</b>	<b>0 986 430 042</b>
				01.93-06.96	6	<b>0 432 231 684</b>	<b>0 986 430 042</b>
<b>S 211 H..</b>	11,0	184	OM 421 A	09.85-12.92	6	<b>0 432 231 814</b>	<b>0 986 430 042</b>
				01.93-06.96	6	<b>0 432 231 684</b>	<b>0 986 430 042</b>
	14,6	206	OM 422.900	01.80-06.96	8	<b>0 432 231 680</b>	<b>0 986 430 038</b>
<b>S 213 H..</b>	14,6	243	OM 422.901 A	09.83-12.92	8	<b>0 432 231 814</b>	<b>0 986 430 042</b>
				01.93-06.96	8	<b>0 432 231 684</b>	<b>0 986 430 042</b>
H..., HR..., RL	14,6	206	OM 422.900	01.80-06.96	8	<b>0 432 231 680</b>	<b>0 986 430 038</b>
<b>S 214 HD..</b>	14,6	206	OM 422.900	09.83-06.96	8	<b>0 432 231 680</b>	<b>0 986 430 038</b>
		243	OM 422.901 A	09.83-12.92	8	<b>0 432 231 814</b>	<b>0 986 430 042</b>
				01.93-06.96	8	<b>0 432 231 684</b>	<b>0 986 430 042</b>
<b>S 215 H..</b>	14,6	243	OM 422.901 A	09.83-12.92	8	<b>0 432 231 814</b>	<b>0 986 430 042</b>
				01.93-06.96	8	<b>0 432 231 684</b>	<b>0 986 430 042</b>
H..., HR..., RL	14,6	206	OM 422.900	01.80-06.96	8	<b>0 432 231 680</b>	<b>0 986 430 038</b>
<b>HDH</b>	14,6	320	OM 442 LA				
			Mot.Nr. →860061	06.96-06.01	8	<b>0 432 131 801</b>	<b>0 986 430 265</b>
					8	<b>0 432 131 804<sup>1</sup></b>	
			Mot.Nr. 860062→	06.96-06.01	8	<b>0 432 131 726</b>	<b>0 986 430 326</b>
					8	<b>0 432 131 730<sup>1</sup></b>	





◀ KÄSSBOHRER

<b>S 215 SL</b>	12,0	177	OM 447.901 h.II	09.85-09.93	6	<b>0 432 231 743</b>
				10.93-06.96	6	<b>0 432 231 681</b>
<b>S 216 HDS..</b>	14,6	243	OM 422.901 A	07.80-12.92	8	<b>0 432 231 814 0 986 430 042</b>
				01.93-06.96	8	<b>0 432 231 684 0 986 430 042</b>
		276	OM 422.901-500 LA	09.85-12.92	8	<b>0 432 231 814 0 986 430 042</b>
				01.93-06.96	8	<b>0 432 231 684 0 986 430 042</b>
<b>S 217 HDH.</b>	14,6	280	OM 442 LA <Euro 2> Mot.Nr. →860061	01.89-06.96	8	<b>0 432 131 800 0 986 430 264</b>
					8	<b>0 432 131 803 †</b>
					8	<b>0 432 131 728 0 986 430 327</b>
					8	<b>0 432 131 729 †</b>
		320	OM 442 LA <Euro 2> Mot.Nr. →860061	01.89-06.96	8	<b>0 432 131 801 0 986 430 265</b>
					8	<b>0 432 131 804 †</b>
					8	<b>0 432 131 726 0 986 430 326</b>
					8	<b>0 432 131 730 †</b>
<b>S 228 DT..</b>	14,6	243	OM 422.901 A	09.85-12.92	8	<b>0 432 231 814 0 986 430 042</b>
				01.93-06.96	8	<b>0 432 231 684 0 986 430 042</b>
		276	OM 422.901-500 LA	03.82-12.92	8	<b>0 432 231 814 0 986 430 042</b>
				01.93-06.96	8	<b>0 432 231 684 0 986 430 042</b>
		280	OM 442 LA Mot.Nr. →860061	01.89-06.96	8	<b>0 432 131 800 0 986 430 264</b>
					8	<b>0 432 131 803 †</b>
	8			<b>0 432 131 728 0 986 430 327</b>		
	8			<b>0 432 131 729 †</b>		
<b>S 250 Spezial</b>	12,0	272	D 2866 LOH 22	07.94-06.96	6	<b>0 432 131 853 0 986 430 196</b>
<b>S 312 HD</b>	14,6	280	OM 442 LA Mot.Nr. →860061	09.91-07.01	8	<b>0 432 131 800 0 986 430 264</b>
					8	<b>0 432 131 803 †</b>
					8	<b>0 432 131 728 0 986 430 327</b>
			Mot.Nr. 860062→	09.91-07.01	8	<b>0 432 131 729 †</b>

**KAVZ KURGAN**

**Serie 4000**

<b>4239</b>	7,1	162	BF6M 1013-22E3 <Euro 3>	09.08→	6	<b>0 432 191 326</b>
			BF6M 1013-33E3 <Euro 3>	09.08→	6	<b>0 432 191 327</b>

**KIA**

**Ceres**

<b>2.4 D</b>	2,4	72	SC	06.99→	4	<b>9 430 610 098</b>
--------------	-----	----	----	--------	---	----------------------

**LAZ**

**A191N**

<b>6.9</b>	6,9	206	D 0836 LOH02 <Euro 3>	01.08→	6	<b>0 432 133 766</b>
------------	-----	-----	-----------------------	--------	---	----------------------

**LEYLAND**

**FT**

<b>95</b>	11,6	225	DAF-WS 225 ATi	09.87-02.88	6	<b>0 432 291 647</b>	
				03.88-03.89 CSA	6	<b>0 432 291 602</b>	
			259	DAF-WS 259 ATi	09.87-02.88	6	<b>0 432 291 627</b>
					03.88-03.89	6	<b>0 432 291 603</b>
			282	DAF-WS 282 ATi	09.87-02.88	6	<b>0 432 291 627</b>
					03.88-03.89	6	<b>0 432 291 603</b>





## LEYLAND-DAF

95							
.310	11,6	225	WS 225 ATi	04.89-12.01	CSA	6	0 432 291 602
.350	11,6	259	WS 259 ATi	04.89-12.01		6	0 432 291 603
.380	11,6	282	WS 282 ATi	04.89-12.01		6	0 432 291 603

## MACK (TRUCKS)

FR							
1	11,0	250	EE6-335	10.86→		6	9 430 233 008

## MAHINDRA

Bolero Camper							
2.5 D	2,5	43	MDI 3200 D	06.03-11.03		4	F 002 C8Z 867
				12.03→		4	F 002 C8Z 881
				74	NEF TCI	10.04→	
D [India 2000]	2,5	43	MDI 3200 L	06.03-06.05		4	F 002 C8Z 868
D 4WD	2,5	46	MDI 3200 TC	07.05-05.07		4	F 002 C8Z 881
4WD [India 2000]	2,5	43	MDI 3200 A	06.03-06.05		4	F 002 C8Z 867

## MAN

Ale							
	4,6		D 0834 LOH01 <V5101, Euro 3>	02.00-12.01		4	0 432 133 765
						4	0 432 133 799 <sup>1</sup>
				125	D 0824 LOH05 <V1901, Euro 3>	01.99-01.00	
Bus 8t							
8.136 FAE, FOC	5,7	100	D 0226 MF	03.82-08.88		6	0 432 231 820
8.150 FAE, FOC	6,9	110	D 0826 GF03 <Z8300, Euro 1>	10.92-05.95		6	0 432 133 872
				FOC	6,9	110-114	D 0826 GF01 <Z8300>
				04.90-10.93		6	0 432 231 718
	4,6	114-118	D 0824 LFO01 <V1700, Euro 2>	02.95-07.98		4	0 432 131 820 0 986 430 257
8.160 FOC, FOCL	4,6	114-118	D 0824 LFL09 <V1700, Euro 2>	07.98-02.01		4	0 432 131 820 0 986 430 257
8.170 FOC	5,7	125-131	D 0226 MCFO; D 0226 MCFO/170	09.85-10.93		6	0 432 231 788
8.220 FOC, FOCL	6,9	162	D 0826 LFL03 <V2300, Euro 2>	04.95-02.01		6	0 432 133 855 0 986 430 313
			D 0826 LFL10 <V2300, Euro 2>	07.98-09.01		6	0 432 131 820 0 986 430 257
Bus 9t							
9.136 FAE, FOC	5,7	100	D 0226 MF	03.82-08.88		6	0 432 231 820
9.150 FAE, FOC	6,9	110	D 0826 GF03 <Z8300, Euro 1>	10.92-05.95		6	0 432 133 872
				FOC	6,9	110-114	D 0826 GF01 <Z8300>
				04.90-10.93		6	0 432 231 718
9.170 FOC	5,7	125-131	D 0226 MCFO; D 0226 MCFO/170	09.85-10.93		6	0 432 231 788
Bus 10t							
10.150 FOC [L2000]	4,6	114-118	D 0824 LFO-01 <V1700, Euro 2>	02.95-01.96		4	0 432 131 820 0 986 430 257
				HOCL	6,9	110-114	D 0826 OH02 <Z9300>
10.180 HOCL	6,9	130-137	D 0826 TOH01 <Z8600>	01.88-05.92		6	0 432 131 820 0 986 430 257
10.220 FOC, FOCL [L2000]	6,9	162	D 0826 LFL03 <V2300, Euro 2>	02.95-02.01		6	0 432 133 855 0 986 430 313
			D 0826 LFL10 <V2300, Euro 2>	07.98-09.01		6	0 432 131 820 0 986 430 257
Bus 11t							
11.150 HOCL	6,9	110-114	D 0826 OH02 <Z9300>	05.92-02.93		6	0 432 133 872
11.190 HOCL	6,9	140	D 0826 LOH02 <V0900, Euro 2>;	04.92-09.96		6	0 432 131 820 0 986 430 257
			D 0826 LOH06 <V0900, Euro 1>				
11.220 HOCL	6,9	162	D 0826 LOH15 <V2900, >	11.95-12.00		6	0 432 133 855 0 986 430 313
			D 0826 LOH19 <V2900, Euro 2>	07.98-09.01		6	0 432 131 820 0 986 430 257
			D 0826 LUH12 <V0300, Euro 2>	07.98-12.00		6	0 432 133 842 <sup>1</sup>
						6	0 432 133 855 0 986 430 313















◀ MAN

<b>11.220</b> HOCL	6,9	162	D 0836 LOH03 <V4900, Euro 3>	01.01-05.01	6	<b>0 432 133 799</b> <sup>1</sup>
				01.01-12.04	6	<b>0 432 133 765</b>
<b>11.230</b> HOCL	6,9	169	D 0826 LOH03 <V0900, Euro 1>	04.93-02.96	6	<b>0 432 131 820 0 986 430 257</b>
<b>Bus 12t</b>						
<b>12.170</b> FOC, FOCL	5,7	125	D 0226 MKF/170	03.85-04.90	6	<b>0 432 231 788</b>
<b>12.220</b> HOCL [M2000 LE]	6,9	162	D 0836 LFL02 <V3900, Euro 3>	09.02→	6	<b>0 432 133 765</b>
HOCL-NL	6,9	162	D 0826 LOH19 <V2900, Euro 2>	07.98-09.02	6	<b>0 432 131 820 0 986 430 257</b>
			D 0836 LOH03 <V4900, Euro 3>	04.99-05.01	6	<b>0 432 133 799</b> <sup>1</sup>
				04.99-09.06	6	<b>0 432 133 765</b>
HOCL-SR	6,9	162	D 0836 LOH03 <V4900, Euro 3>	03.03-09.06	6	<b>0 432 133 765</b>
					6	<b>0 432 133 799</b> <sup>1</sup>
<b>12.280</b> HOCL-NL	6,9	206	D 0836 LOH02 <V4900, Euro 3>	04.01-09.02	6	<b>0 432 133 766</b>
<b>Bus 13t</b>						
<b>13.220</b> HOCL	6,9	162	D 0826 LOH15 <V2900,>	07.98-09.01	6	<b>0 432 133 855 0 986 430 313</b>
			D 0826 LUH12 <V0300, Euro 2>	07.98-09.01	6	<b>0 432 133 842</b> <sup>1</sup>
					6	<b>0 432 133 855 0 986 430 313</b>
			D 0836 LOH03 <V4900, Euro 3>	09.01-05.04	6	<b>0 432 133 765</b>
<b>Bus 14t</b>						
<b>14.170</b> FOC	5,7	125	D 0226 MKF/170	04.85-04.90	6	<b>0 432 231 788</b>
<b>14.192</b> FOC	5,7	141	D 0226 MKF	04.85-03.90	6	<b>0 432 231 788</b>
<b>14.220</b> HOCL-NL	6,9	162	D 0826 LOH19 <V2900, Euro 2>	07.98-09.01	6	<b>0 432 131 820 0 986 430 257</b>
			D 0826 LUH12 <V0300, Euro 2>	07.98-09.01	6	<b>0 432 133 842</b> <sup>1</sup>
					6	<b>0 432 133 855 0 986 430 313</b>
			D 0836 LOH03 <V4900, Euro 3>	01.01-05.01	6	<b>0 432 133 799</b> <sup>1</sup>
				01.01-09.06	6	<b>0 432 133 765</b>
		206	D 0836 LOH02 <V4900, Euro 3>	01.02-09.02	6	<b>0 432 133 766</b>
<b>14.280</b> HOCL-SR	6,9	206	D 0836 LOH02 <V4900, Euro 3>	06.03-10.06	6	<b>0 432 133 766</b>
<b>Bus 16t</b>						
<b>16.280</b> HOC, HOCL	11,4	206	D 2566 MTHO	02.84-04.87 CSA	6	<b>0 432 231 839</b>
<b>16.290</b> HOC, HOCL	12,0	213-229	D 2866 TOH <Z7900>; D 2866 TOH/290 <Z7900>; D 2866 TOH/310 <Z7900>	04.87-03.93	6	<b>0 432 231 778 0 986 430 159</b>
<b>16.360</b> HOCL	12,0	274	D 2866 LOH07 <Z7700>	02.93-04.94	6	<b>0 432 131 853 0 986 430 196</b>
<b>16.370</b> HOCL	12,0	272/274	D 2866 LOH07 <Z7700>; D 2866 LOH22 <V1500, Euro 1>	04.94-06.97	6	<b>0 432 131 853 0 986 430 196</b>
<b>Bus 17t</b>						
<b>17.192</b> GM2	6,9	140	D 0826 LF05 <Z9500, Euro 1>	07.93-05.94	6	<b>0 432 131 820 0 986 430 257</b>
<b>17.232</b> GM2	6,9	169	D 0826 LF02 <Z9500>	03.91-10.92	6	<b>0 432 131 858</b>
			D 0826 LF06 <Z9500, Euro 1>	07.93-05.94	6	<b>0 432 131 820 0 986 430 257</b>
<b>Bus 18t</b>						
<b>LE 232</b> FOC [M2000 LE]	6,9	162	D 0826 LFL10 <V2300, Euro 2>	08.00→	6	<b>0 432 131 820 0 986 430 257</b>
<b>LE 282</b> FOC [M2000 LE]	6,9	206	D 0836 LF01 <V4000, Euro 2>	09.00-02.02	6	<b>0 432 133 797</b> <sup>1</sup>
				09.00→	6	<b>0 432 133 766</b>
<b>18.220</b> HOCL-NL	6,9	162	D 0826 LOH19 <V2900, Euro 2>	07.98-09.01	6	<b>0 432 131 820 0 986 430 257</b>
			D 0836 LOH03 <V4900, Euro 3>	01.01-05.01	6	<b>0 432 133 799</b> <sup>1</sup>
				01.01-09.06	6	<b>0 432 133 765</b>
<b>18.232</b> FOC/HOC [M2000]	6,9	162	D 0826 LFL10 <V2300, Euro 2>	03.97→	6	<b>0 432 131 820 0 986 430 257</b>
<b>18.260</b> HOCL	12,0	191	D 2866 LOH35 <V4800, Euro 3>	06.01-09.06	6	<b>0 432 191 417</b> <sup>1</sup>
					6	<b>0 432 191 419</b>
HOCL, HOCL-NL	12,0	191	D 2866 LOH31 <V1500, Euro 2>; D 2866 LUH22 <V3200, Euro 2>	09.96-09.01	6	<b>0 432 131 631</b> <sup>1</sup>
					6	<b>0 432 131 633</b>
HOCL-NL	12,0	191	D 2866 LUH23 <V5000, Euro 3>	06.01-09.06	6	<b>0 432 191 417</b> <sup>1</sup>
					6	<b>0 432 191 419</b>
<b>18.280</b> HOCL-NL	6,9	206	D 0836 LOH02 <V4900, Euro 3>	04.01-09.06	6	<b>0 432 133 766</b>
<b>18.282</b> FOC	7,0	206	D 0836 LFLO1	09.96→	6	<b>0 432 133 766</b>
					6	<b>0 432 133 797</b> <sup>1</sup>
FOC [M2000]	6,9	206	D 0836 LF01 <V4000, Euro 2>	09.01→	6	<b>0 432 133 766</b>
					6	<b>0 432 133 797</b> <sup>1</sup>
<b>18.292</b> FOC [M2000]	6,9	206	D 0836 LF01 <V4000, Euro 2>	09.00→	6	<b>0 432 133 766</b>
					6	<b>0 432 133 797</b> <sup>1</sup>
<b>18.310</b> HOCL	12,0	228	D 2866 LOH27 <V4800, Euro 3>	01.01-09.06	6	<b>0 432 191 417</b> <sup>1</sup>
					6	<b>0 432 191 419</b>
		230	D 2866 LOH24 <V1500, Euro 1>	03.95-09.96	6	<b>0 430 133 994</b>
			D 2866 LOH25 <V1500, Euro 2>	09.96-09.01	6	<b>0 432 131 633</b>



										
<b>18.310</b> HOCL-NL	12,0	228	D 2866 LUH24 <V5000, Euro 3>		01.01-09.06		6	<b>0 432 191 417</b> <sup>1</sup>		
			D 2866 LUH26 <V3200, Euro 2>		07.98-09.06		6	<b>0 432 191 419</b>		
							6	<b>0 432 131 631</b> <sup>1</sup>		
							6	<b>0 432 131 633</b>		
<b>18.320</b> HOCL	10,0	235	D 2865 LOH02 <V2200, Euro 1>		02.94-02.95		5	<b>0 432 131 831</b>	<b>0 986 430 228</b>	
<b>18.350</b> HOCL	12,0	257	D 2866 LOH26 <V1500, Euro 2>		09.96-09.01		6	<b>0 432 131 631</b> <sup>1</sup>		
							6	<b>0 432 131 633</b>		
<b>18.360</b> HOCL	12,0	265	D 2866 LOH28 <V4800, Euro 3>		01.01-09.06		6	<b>0 432 191 417</b> <sup>1</sup>		
							6	<b>0 432 191 419</b>		
<b>18.370</b> HOCL	12,0	274	D 2866 LOH07 <Z7700, Euro 1>		04.93-09.96		6	<b>0 432 131 853</b>	<b>0 986 430 196</b>	
<b>18.400</b> HOCL	12,0	294	D 2866 LOH23 <V1500, Euro 2>		01.01-09.01		6	<b>0 432 131 734</b> <sup>1</sup>		
							6	<b>0 432 131 788</b>	<b>0 986 430 312</b>	
			D 2866 LOH24 <V1500, Euro 2>		09.96-12.00		6	<b>0 430 133 994</b>		
<b>18.410</b> HOC	12,0	301	D 2866 LOH29 <V4800, Euro 3>		09.02-09.06		6	<b>0 432 191 417</b> <sup>1</sup>		
							6	<b>0 432 191 419</b>		
HOCL	12,8	302	D 2876 LOH05 <V4500, Euro 2>		01.99-09.01		6	<b>0 432 191 415</b> <sup>1</sup>		
							6	<b>0 432 191 416</b>		
<b>18.420</b> HOCL	12,0	309	D 2866 LOH06 <Z7700, Euro 1>		04.93-09.96		6	<b>0 432 231 778</b>	<b>0 986 430 159</b>	
<b>18.460</b> HOCL	11,8	338	D 2876 LOH02 <V4500, Euro 3>		01.01-09.06		6	<b>0 432 191 414</b> <sup>1</sup>		
							6	<b>0 432 191 416</b>		
<b>Bus 22t</b>										
<b>22.192</b> FVL-KO	9,5	141	D 2565 MF		07.81-09.90		5	<b>0 432 231 850</b>		
<b>22.280</b> HOCLN	11,4	206	D 2566 MTHO		05.85-12.86	CSA	6	<b>0 432 231 839</b>		
<b>22.330</b> HOCLN	12,0	243	D 2866 LOH		05.85-09.89		6	<b>0 432 231 778</b>	<b>0 986 430 159</b>	
<b>22.331</b> HOCLN	12,0	243	D 2866 LOH		09.89-05.90		6	<b>0 432 231 778</b>	<b>0 986 430 159</b>	
<b>22.360</b> HOCLN	12,0	265	D 2866 KOH <Z5000>		06.86-09.89		6	<b>0 432 231 778</b>	<b>0 986 430 159</b>	
		274	D 2866 LOH07 <Z7700>		02.93-04.93		6	<b>0 432 131 853</b>	<b>0 986 430 196</b>	
<b>22.361</b> HOCLN	12,0	265-274	D 2866 LX04		09.89-04.92		6	<b>0 432 131 853</b>	<b>0 986 430 196</b>	
<b>22.370</b> HOCLN	12,0	274	D 2866 LOH07 <Z7700, EURO 1>		04.93-11.95		6	<b>0 432 131 853</b>	<b>0 986 430 196</b>	
<b>22.400</b> HOCLN	12,0	294	D 2866 LOH03 <Z7700, Euro 2>		09.96-12.00		6	<b>0 432 131 853</b>	<b>0 986 430 196</b>	
<b>22.420</b> HOCLN	12,0	309	D 2866 LOH06 <Z7700, Euro 1>		11.95-12.00		6	<b>0 432 231 778</b>	<b>0 986 430 159</b>	
<b>Bus 24t</b>										
<b>24.310</b> HOCLNL	12,0	228	D 2866 LOH25 <V1500, Euro 2>		07.98-09.01		6	<b>0 432 131 633</b>		
			D 2866 LOH27 <V4800, Euro 3>		01.01-09.02		6	<b>0 432 191 417</b> <sup>1</sup>		
							6	<b>0 432 191 419</b>		
<b>24.350</b> HOCLN, HOCLNL	12,0	258	D 2866 LOH26 <V1500, Euro 2>		07.98-09.01		6	<b>0 432 131 631</b> <sup>1</sup>		
							6	<b>0 432 131 633</b>		
<b>24.360</b> HOCLLN	12,0	265	D 2866 LOH28 <V4800, Euro 3>		09.02-09.06		6	<b>0 432 191 417</b> <sup>1</sup>		
							6	<b>0 432 191 419</b>		
<b>24.400</b> HOCLLN, HOCLN	12,0	294	D 2866 LOH23 <V1500, Euro 2>		07.98-09.01		6	<b>0 432 131 734</b> <sup>1</sup>		
							6	<b>0 432 131 788</b>	<b>0 986 430 312</b>	
HOCLN	12,0	294	D 2866 LOH24 <V1500, Euro 2>		07.96-12.00		6	<b>0 430 133 994</b>		
<b>24.410</b> HOCLLN, HOCLN	12,0	301	D 2866 LOH29 <V4800, Euro 3>		09.02-09.06		6	<b>0 432 191 417</b> <sup>1</sup>		
							6	<b>0 432 191 419</b>		
		12,8	301/302	D 2876 LOH05 <V4500, Euro 2>	07.98-09.01		6	<b>0 432 191 415</b> <sup>1</sup>		
							6	<b>0 432 191 416</b>		
<b>24.460</b> HOCLLN, HOCLN	12,8	338	D 2876 LOH01 <V3300, Euro 2>		11.99-09.01		6	<b>0 432 131 733</b> <sup>1</sup>		
							6	<b>0 432 131 760</b>	<b>0 986 430 451</b>	
		339	D 2876 LOH02 <V4500, Euro 3>		01.01-09.06		6	<b>0 432 191 414</b> <sup>1</sup>		
							6	<b>0 432 191 416</b>		
<b>Bus 26t</b>										
<b>26.240</b> DF-KO	11,4	177	D 2566 MF		12.81-08.88		6	<b>0 432 231 850</b>		
<b>EL / EM</b>										
<b>EL 202</b> [A12]	6,9	157/184/198	D 0826 LUH <V0300, Euro 1>; D 0826 LUH03 <V0300, Euro 1>		01.93-06.97		6	<b>0 432 131 820</b>	<b>0 986 430 257</b>	
F [A17]	6,9	184/198	D 0826 LUH <V0300, Euro 1>		02.96-06.97		6	<b>0 432 131 820</b>	<b>0 986 430 257</b>	
<b>EL 222</b> [A12]	6,9	162	D 0826 LUH12 <V0300, Euro 2>		11.95-09.01		6	<b>0 432 133 842</b> <sup>1</sup>		
							6	<b>0 432 133 855</b>	<b>0 986 430 313</b>	
F [A17]	6,9	162	D 0826 LUH12 <V0300, Euro 2>		06.97-05.99		6	<b>0 432 133 842</b> <sup>1</sup>		
							6	<b>0 432 133 855</b>	<b>0 986 430 313</b>	
<b>EL 262</b> [A12]	6,9	191	D 0826 LUH13 <V0300, Euro 2>		02.96-09.01		6	<b>0 432 133 840</b>		
							6	<b>0 432 133 841</b> <sup>1</sup>		















◀ MAN

<b>EL 262</b> [A12]	12,0	191	D 2866 LUH22 <V3200, Euro 2>	07.98-09.01	6	<b>0 432 131 631</b> <sup>1</sup>
					6	<b>0 432 131 633</b>
F [A17]	6,9	191	D 0826 LUH13 <V0300, Euro 2>	06.97-05.99	6	<b>0 432 133 840</b>
					6	<b>0 432 133 841</b> <sup>1</sup>
<b>EM 11.222</b> [469]	6,9	162	D 0826 LOH15 <V2900,>	02.96-09.01	6	<b>0 432 133 855</b> <b>0 986 430 313</b>
<b>EM 13.222</b> [A53]	6,9	162	D 0826 LUH12 <V0300, Euro 2>	06.97-09.01	6	<b>0 432 133 842</b> <sup>1</sup>
					6	<b>0 432 133 855</b> <b>0 986 430 313</b>
[469]	6,9	162	D 0826 LUH12 <V0300, Euro 2>	06.97-09.01	6	<b>0 432 133 842</b> <sup>1</sup>
					6	<b>0 432 133 855</b> <b>0 986 430 313</b>
<b>EM 192</b> [469]	6,9	140	D 0826 LOH06 <V0900, Euro 1>	10.93-06.97	6	<b>0 432 131 820</b> <b>0 986 430 257</b>
<b>EM 220</b> [469]	6,9	162	D 0836 LOH03 <V4900, Euro 3>	11.99-05.01	6	<b>0 432 133 799</b> <sup>1</sup>
				11.99-12.04	6	<b>0 432 133 765</b>
<b>E2000</b>						
<b>19.293</b> FA, FL	10,0	213	D 2865 LF24 <V2500, Euro 2>	06.96-09.01	5	<b>0 432 131 633</b>
<b>19.314</b> FALS/FALK, FL	12,0	228	D 2866 LF34 <V2600, Euro 2>	06.98-09.01	6	<b>0 432 131 631</b> <sup>1</sup>
					6	<b>0 432 131 633</b>
<b>19.343</b> FA, FL	10,0	250	D 2865 LF21 <V2500, Euro 2>	06.96-09.01	5	<b>0 432 131 734</b> <sup>1</sup>
					5	<b>0 432 131 788</b> <b>0 986 430 312</b>
<b>19.364</b> FA, FLS/FLK	12,0	265	D 2866 LF35 <V2600, Euro 2>	06.98-09.01	6	<b>0 432 131 631</b> <sup>1</sup>
					6	<b>0 432 131 633</b>
<b>19.403</b> FA, FL	12,0	294	D 2866 LF20 <V2600, Euro 2>	06.96-09.01	6	<b>0 432 131 734</b> <sup>1</sup>
					6	<b>0 432 131 788</b> <b>0 986 430 312</b>
<b>19.414</b> FA, FLS/FLK	12,0	301	D 2866 LF31 <V2600, Euro 2>	03.00-12.01	6	<b>0 432 191 416</b>
				05.00-12.01	6	<b>0 432 191 415</b> <sup>1</sup>
<b>19.463</b> FA, FL	12,8	338	D 2876 LF02 <V2400, Euro 2>	06.96-09.01	6	<b>0 432 131 733</b> <sup>1</sup>
					6	<b>0 432 131 760</b> <b>0 986 430 451</b>
<b>19.464</b> FALS/FALK, FLS/FLK	12,8	338	D 2876 LF06 <V2400, Euro 2>	06.98-01.00	6	<b>0 432 191 483</b>
				06.98-04.00	6	<b>0 432 191 482</b> <sup>1</sup>
				02.00-09.01	6	<b>0 432 191 416</b>
				05.00-09.01	6	<b>0 432 191 415</b> <sup>1</sup>
<b>26.293</b> F, FA, FL	10,0	213	D 2865 LF24 <V2500, Euro 2>	09.96-09.01	5	<b>0 432 131 633</b>
<b>26.314</b> FA	12,0	228	D 2866 LF34 <V2600, Euro 2>	07.99-09.01	6	<b>0 432 131 631</b> <sup>1</sup>
					6	<b>0 432 131 633</b>
<b>26.343</b> F, FA, FL	10,0	250	D 2865 LF21 <V2500, Euro 2>	09.96-09.01	5	<b>0 432 131 734</b> <sup>1</sup>
					5	<b>0 432 131 788</b> <b>0 986 430 312</b>
<b>26.364</b> FAV	12,0	265	D 2866 LF35 <V2600, Euro 2>	07.99-09.01	6	<b>0 432 131 631</b> <sup>1</sup>
					6	<b>0 432 131 633</b>
<b>26.403</b> F, FA, FL	12,0	294	D 2866 LF20 <V2600, Euro 2>	09.96-09.01	6	<b>0 432 131 734</b> <sup>1</sup>
					6	<b>0 432 131 788</b> <b>0 986 430 312</b>
<b>26.414</b> FAVL	12,0	301	D 2866 LF31 <V2600, Euro 2>	03.00-12.01	6	<b>0 432 191 416</b>
				05.00-12.01	6	<b>0 432 191 415</b> <sup>1</sup>
<b>26.463</b> F, FA, FL	12,8	338	D 2876 LF02 <V2400, Euro 2>	09.96-09.01	6	<b>0 432 131 733</b> <sup>1</sup>
					6	<b>0 432 131 760</b> <b>0 986 430 451</b>
<b>26.464</b> FA	12,8	338	D 2876 LF06 <V2400, Euro 2>	07.99-01.00	6	<b>0 432 191 483</b>
				07.99-04.00	6	<b>0 432 191 482</b> <sup>1</sup>
				02.00-09.01	6	<b>0 432 191 416</b>
				05.00-09.01	6	<b>0 432 191 415</b> <sup>1</sup>
<b>28.293</b> FNL	10,0	213	D 2865 LF24 <V2500, Euro 2>	09.96-09.01	5	<b>0 432 131 633</b>
<b>28.314</b> FNLC	12,0	228	D 2866 LF34 <V2600, Euro 2>	07.99-03.01	6	<b>0 432 131 631</b> <sup>1</sup>
					6	<b>0 432 131 633</b>
<b>28.343</b> FANL, FNL	10,0	250	D 2865 LF21 <V2500, Euro 2>	09.96-09.01	5	<b>0 432 131 734</b> <sup>1</sup>
					5	<b>0 432 131 788</b> <b>0 986 430 312</b>
<b>28.364</b>	12,0	265	D 2866 LF35 <V2600, Euro 2>	07.99-09.01	6	<b>0 432 131 631</b> <sup>1</sup>
					6	<b>0 432 131 633</b>
<b>28.403</b> FANL, FNL	12,0	294	D 2866 LF20 <V2600, Euro 2>	09.96-09.01	6	<b>0 432 131 734</b> <sup>1</sup>
					6	<b>0 432 131 788</b> <b>0 986 430 312</b>
<b>28.414</b> , FNLC	12,0	301	D 2866 LF31 <V2600, Euro 2>	03.00-12.01	6	<b>0 432 191 416</b>
				05.00-12.01	6	<b>0 432 191 415</b> <sup>1</sup>
<b>28.463</b> FANL, FNL	12,8	338	D 2876 LF02 <V2400, Euro 2>	09.96-09.01	6	<b>0 432 131 733</b> <sup>1</sup>
					6	<b>0 432 131 760</b> <b>0 986 430 451</b>



									
<b>28.464</b> , FL	12,8	338	D 2876 LF06 <V2400, Euro 2>				6	<b>0 432 191 483</b>	
							6	<b>0 432 191 482</b> <sup>1</sup>	
							6	<b>0 432 191 416</b>	
							6	<b>0 432 191 415</b> <sup>1</sup>	
<b>30.293</b> FNL	10,0	213	D 2865 LF24 <V2500, Euro 2>			03.97-09.01	5	<b>0 432 131 633</b>	
<b>30.314</b> FNLC	12,0	228	D 2866 LF34 <V2600, Euro 2>			06.98-09.01	6	<b>0 432 131 631</b> <sup>1</sup>	
							6	<b>0 432 131 633</b>	
<b>30.343</b> FANL, FNL	10,0	250	D 2865 LF21 <V2500, Euro 2>			03.97-09.01	5	<b>0 432 131 734</b> <sup>1</sup>	
							5	<b>0 432 131 788</b>	<b>0 986 430 312</b>
<b>30.364</b> FANLC, FNLC	12,0	265	D 2866 LF35 <V2600, Euro 2>			06.98-09.01	6	<b>0 432 131 631</b> <sup>1</sup>	
							6	<b>0 432 131 633</b>	
FNLC	12,0	265	D 2866 LF24 <V2600, Euro 3>			01.00-09.02	6	<b>0 432 191 418</b> <sup>1</sup>	
							6	<b>0 432 191 419</b>	
<b>30.403</b> FANL, FNL	12,0	294	D 2866 LF20 <V2600, Euro 2>			03.97-09.01	6	<b>0 432 131 734</b> <sup>1</sup>	
							6	<b>0 432 131 788</b>	<b>0 986 430 312</b>
<b>30.414</b> FANLC, FNLC	12,0	301	D 2866 LF31 <V2600, Euro 2>			03.00-12.01	6	<b>0 432 191 416</b>	
							6	<b>0 432 191 415</b> <sup>1</sup>	
<b>30.463</b> FANL, FNL	12,8	338	D 2876 LF02 <V2400, Euro 2>			03.97-09.01	6	<b>0 432 131 733</b> <sup>1</sup>	
							6	<b>0 432 131 760</b>	<b>0 986 430 451</b>
<b>30.464</b> FANLC, FNLC	12,8	338	D 2876 LF06 <V2400, Euro 2>			06.98-01.00	6	<b>0 432 191 483</b>	
							6	<b>0 432 191 482</b> <sup>1</sup>	
							6	<b>0 432 191 416</b>	
							6	<b>0 432 191 415</b> <sup>1</sup>	
<b>32.293</b> VFL	10,0	213	D 2865 LF24 <V2500, Euro 2>			03.97-09.01	5	<b>0 432 131 633</b>	
<b>32.314</b> VFNLC	12,0	228	D 2866 LF34 <V2600, Euro 2>			07.99-09.01	6	<b>0 432 131 631</b> <sup>1</sup>	
							6	<b>0 432 131 633</b>	
<b>32.343</b> VFL	10,0	250	D 2865 LF21 <V2500, Euro 2>			03.97-09.01	5	<b>0 432 131 734</b> <sup>1</sup>	
							5	<b>0 432 131 788</b>	<b>0 986 430 312</b>
<b>32.364</b> VFNLC	12,0	265	D 2866 LF35 <V2600, Euro 2>			07.99-09.01	6	<b>0 432 131 631</b> <sup>1</sup>	
							6	<b>0 432 131 633</b>	
<b>32.403</b> VFL	12,0	294	D 2866 LF20 <V2600, Euro 2>			03.97-09.01	6	<b>0 432 131 734</b> <sup>1</sup>	
							6	<b>0 432 131 788</b>	<b>0 986 430 312</b>
<b>32.414</b> VFLC	12,0	301	D 2866 LF31 <V2600, Euro 2>			03.00-12.01	6	<b>0 432 191 416</b>	
							6	<b>0 432 191 415</b> <sup>1</sup>	
<b>32.463</b> VFL	12,8	338	D 2876 LF02 <V2400, Euro 2>			03.97-09.01	6	<b>0 432 131 733</b> <sup>1</sup>	
							6	<b>0 432 131 760</b>	<b>0 986 430 451</b>
<b>32.464</b> VFNLC	12,8	338	D 2876 LF06 <V2400, Euro 2>			07.99-01.00	6	<b>0 432 191 483</b>	
							6	<b>0 432 191 482</b> <sup>1</sup>	
							6	<b>0 432 191 416</b>	
							6	<b>0 432 191 415</b> <sup>1</sup>	
<b>33.293</b> DFL	10,0	213	D 2865 LF24 <V2500, Euro 2>			09.96-09.01	5	<b>0 432 131 633</b>	
<b>33.343</b> DFAL, DFL	10,0	250	D 2865 LF21 <V2500, Euro 2>			09.96-09.01	5	<b>0 432 131 734</b> <sup>1</sup>	
							5	<b>0 432 131 788</b>	<b>0 986 430 312</b>
<b>33.364</b> , DFAL, DFL	12,0	265	D 2866 LF35 <V2600, Euro 2>			10.97-09.01	6	<b>0 432 131 631</b> <sup>1</sup>	
							6	<b>0 432 131 633</b>	
<b>33.403</b> DFAL, DFL	12,0	294	D 2866 LF20 <V2600, Euro 2>			09.96-09.01	6	<b>0 432 131 734</b> <sup>1</sup>	
							6	<b>0 432 131 788</b>	<b>0 986 430 312</b>
<b>33.414</b> , DFAL, DFL	12,0	301	D 2866 LF31 <V2600, Euro 2>			03.00-12.01	6	<b>0 432 191 416</b>	
							6	<b>0 432 191 415</b> <sup>1</sup>	
<b>33.463</b> DFAL, DFL	12,8	338	D 2876 LF02 <V2400, Euro 2>			09.96-09.01	6	<b>0 432 131 733</b> <sup>1</sup>	
							6	<b>0 432 131 760</b>	<b>0 986 430 451</b>
<b>33.464</b>	12,8	338	D 2876 LF02 <V2400, Euro 2>			10.97-09.01	6	<b>0 432 131 733</b> <sup>1</sup>	
							6	<b>0 432 131 760</b>	<b>0 986 430 451</b>
							6	<b>0 432 191 483</b>	
							6	<b>0 432 191 482</b> <sup>1</sup>	
DFAL, DFL	12,8	301/338	D 2876 LF06 <V2400, Euro 2>			06.98-01.00	6	<b>0 432 191 483</b>	
						06.98-04.00	6	<b>0 432 191 482</b> <sup>1</sup>	
						02.00-09.01	6	<b>0 432 191 416</b>	
						05.00-09.01	6	<b>0 432 191 415</b> <sup>1</sup>	
<b>33.604</b> DFSL	18,3	441	D 2840 LF21 <V3400, Euro 2>			08.97-01.99	10	<b>0 432 133 819</b>	
<b>35.343</b> VF, VFA	10,0	250	D 2865 LF21 <V2500, Euro 2>			06.96-09.01	5	<b>0 432 131 734</b> <sup>1</sup>	
							5	<b>0 432 131 788</b>	<b>0 986 430 312</b>
<b>35.364</b> VF, VFA	12,0	265	D 2866 LF35 <V2600, Euro 2>			06.98-09.01	6	<b>0 432 131 631</b> <sup>1</sup>	
							6	<b>0 432 131 633</b>	















◀ MAN

<b>35.403</b> FV, VF	12,0	294	D 2866 LF20 <V2600, Euro 2>	06.96-09.01	6	<b>0 432 131 734</b> <sup>1</sup>
					6	<b>0 432 131 788 0 986 430 312</b>
<b>35.414</b> FV	12,0	301	D 2866 LF31 <V2600, Euro 2>	07.99-12.01	6	<b>0 432 191 416</b>
				05.00-12.01	6	<b>0 432 191 415</b> <sup>1</sup>
VF, VFA	12,0	301	D 2866 LF31 <V2600, Euro 2>	03.00-12.01	6	<b>0 432 191 416</b>
				05.00-12.01	6	<b>0 432 191 415</b> <sup>1</sup>
<b>35.463</b> FV, VF, VFA	12,8	338	D 2876 LF02 <V2400, Euro 2>	06.96-09.01	6	<b>0 432 131 733</b> <sup>1</sup>
					6	<b>0 432 131 760 0 986 430 451</b>
<b>35.464</b> FV	12,8	338	D 2876 LF06 <V2400, Euro 2>	07.99-04.00	6	<b>0 432 191 482</b> <sup>1</sup>
				02.00-09.01	6	<b>0 432 191 416</b>
				05.00-09.01	6	<b>0 432 191 415</b> <sup>1</sup>
VF, VFA	12,8	338	D 2876 LF06 <V2400, Euro 2>	06.98-01.00	6	<b>0 432 191 483</b>
				06.98-04.00	6	<b>0 432 191 482</b> <sup>1</sup>
				02.00-09.01	6	<b>0 432 191 416</b>
				05.00-09.01	6	<b>0 432 191 415</b> <sup>1</sup>
<b>40.604</b> DFAS	18,3	441	D 2840 LF21 <V3400, Euro 2>	09.98-01.99	10	<b>0 432 133 819</b>
<b>41.343</b> VF, VFA	10,0	250	D 2865 LF21 <V2500, Euro 2>	06.96-09.01	5	<b>0 432 131 734</b> <sup>1</sup>
					5	<b>0 432 131 788 0 986 430 312</b>
<b>41.364</b> VF, VFA	12,0	265	D 2866 LF35 <V2600, Euro 2>	06.98-09.01	6	<b>0 432 131 631</b> <sup>1</sup>
					6	<b>0 432 131 633</b>
<b>41.403</b> VF, VFA	12,0	294	D 2866 LF20 <V2600, Euro 2>	06.96-09.01	6	<b>0 432 131 734</b> <sup>1</sup>
					6	<b>0 432 131 788 0 986 430 312</b>
<b>41.414</b> VF, VFA	12,0	301	D 2866 LF31 <V2600, Euro 2>	03.00-12.01	6	<b>0 432 191 416</b>
				05.00-12.01	6	<b>0 432 191 415</b> <sup>1</sup>
<b>41.463</b> DFVL, VF, VFA	12,8	338	D 2876 LF02 <V2400, Euro 2>	06.96-09.01	6	<b>0 432 131 733</b> <sup>1</sup>
					6	<b>0 432 131 760 0 986 430 451</b>
<b>41.464</b> DFVL, VF, VFA	12,8	338	D 2876 LF06 <V2400, Euro 2>	06.98-01.00	6	<b>0 432 191 483</b>
				06.98-04.00	6	<b>0 432 191 482</b> <sup>1</sup>
				02.00-09.01	6	<b>0 432 191 416</b>
				05.00-09.01	6	<b>0 432 191 415</b> <sup>1</sup>
<b>41.604</b> DFVLS	18,3	441	D 2840 LF21 <V3400, Euro 2>	02.97-01.99	10	<b>0 432 133 819</b>
<b>42.414</b> VFAK	12,0	301	D 2866 LF25 <V2600, Euro 3>	01.00-08.01	6	<b>0 432 191 418</b> <sup>1</sup>
					6	<b>0 432 191 419</b>
VFAK, VFK	12,0	301	D 2866 LF31 <V2600, Euro 2>	03.00-08.01	6	<b>0 432 191 416</b>
				05.00-08.01	6	<b>0 432 191 415</b> <sup>1</sup>
VFK	12,0	301	D 2866 LF25 <V2600, Euro 3>	01.00-08.01	6	<b>0 432 191 418</b> <sup>1</sup>
<b>42.464</b> VFAK	12,8	338	D 2876 LF03 <V2400, Euro 3>	01.00-04.00	6	<b>0 432 191 482</b> <sup>1</sup>
				01.00-08.01	6	<b>0 432 191 416</b>
			D 2876 LF06 <V2400, Euro 2>	06.98-01.00	6	<b>0 432 191 483</b>
				06.98-04.00	6	<b>0 432 191 482</b> <sup>1</sup>
				02.00-08.01	6	<b>0 432 191 416</b>
				05.00-08.01	6	<b>0 432 191 415</b> <sup>1</sup>
<b>50.414</b> VF, VFA, VFAVK, VFK	12,0	301	D 2866 LF31 <V2600, Euro 2>	03.00-09.01	6	<b>0 432 191 416</b>
				05.00-09.01	6	<b>0 432 191 415</b> <sup>1</sup>
VFAVK	12,8	338	D 2876 LF06 <V2400, Euro 2>	06.98-01.00	6	<b>0 432 191 483</b>
				06.98-04.00	6	<b>0 432 191 482</b> <sup>1</sup>
				02.00-09.01	6	<b>0 432 191 416</b>
				05.00-09.01	6	<b>0 432 191 415</b> <sup>1</sup>
<b>50.464</b> VF, VFA, VFAVK, VFK	12,8	338	D 2876 LF06 <V2400, Euro 2>	06.98-01.00	6	<b>0 432 191 483</b>
				06.98-04.00	6	<b>0 432 191 482</b> <sup>1</sup>
				02.00-09.01	6	<b>0 432 191 416</b>
				05.00-09.01	6	<b>0 432 191 415</b> <sup>1</sup>
<b>E2000 Evol. (FE)</b>						
<b>19.310</b> F, FA	12,0	228	D 2866 LF23 <V2600, Euro 3>	09.02-06.03	6	<b>0 432 191 418</b> <sup>1</sup>
					6	<b>0 432 191 419</b>
<b>19.360</b> F, FA, F, FL	12,0	265	D 2866 LF24 <V2600, Euro 3>	09.02-06.03	6	<b>0 432 191 418</b> <sup>1</sup>
					6	<b>0 432 191 419</b>
<b>19.410</b> F, FA, F, FL	12,0	301	D 2866 LF25 <V2600, Euro 3>	09.02-06.03	6	<b>0 432 191 418</b> <sup>1</sup>
					6	<b>0 432 191 419</b>
<b>19.460</b> F, FA, F, FL	12,8	338	D 2876 LF03 <V2400, Euro 3>	09.01-06.03	6	<b>0 432 191 416</b>
<b>26.360</b> DF	12,0	265	D 2866 LF24 <V2600, Euro 3>	09.02-10.03	6	<b>0 432 191 418</b> <sup>1</sup>
					6	<b>0 432 191 419</b>





									
<b>26.410</b> DF	12,0	301	D 2866 LF25 <V2600, Euro 3>		09.02-10.03		6	<b>0 432 191 418</b> <sup>1</sup>	
							6	<b>0 432 191 419</b>	
<b>26.460</b> DF	12,8	338	D 2876 LF03 <V2400, Euro 3>		09.02-10.03		6	<b>0 432 191 416</b>	
<b>28.310</b> DF	12,0	228	D 2866 LF23 <V2600, Euro 3>		09.02-12.03		6	<b>0 432 191 418</b> <sup>1</sup>	
							6	<b>0 432 191 419</b>	
<b>28.360</b> DA, DF	12,0	265	D 2866 LF24 <V2600, Euro 3>		09.02-11.03		6	<b>0 432 191 418</b> <sup>1</sup>	
							6	<b>0 432 191 419</b>	
<b>28.410</b> DA, DF	12,0	301	D 2866 LF25 <V2600, Euro 3>		08.02-11.03		6	<b>0 432 191 418</b> <sup>1</sup>	
							6	<b>0 432 191 419</b>	
<b>28.460</b> DA, DF	12,8	338	D 2876 LF03 <V2400, Euro 3>		09.02-11.03		6	<b>0 432 191 416</b>	
<b>30.360</b> DF	12,0	265	D 2866 LF24 <V2600, Euro 3>		09.02-06.03		6	<b>0 432 191 418</b> <sup>1</sup>	
							6	<b>0 432 191 419</b>	
<b>30.410</b> DF	12,0	301	D 2866 LF25 <V2600, Euro 3>		09.02-06.03		6	<b>0 432 191 418</b> <sup>1</sup>	
							6	<b>0 432 191 419</b>	
<b>30.460</b> DF	12,8	338	D 2876 LF03 <V2400, Euro 3>		09.02-06.03		6	<b>0 432 191 416</b>	
<b>32.360</b> VF	12,0	265	D 2866 LF24 <V2600, Euro 3>		09.02-10.03		6	<b>0 432 191 418</b> <sup>1</sup>	
							6	<b>0 432 191 419</b>	
<b>32.410</b> VF	12,0	301	D 2866 LF25 <V2600, Euro 3>		09.02-10.03		6	<b>0 432 191 418</b> <sup>1</sup>	
							6	<b>0 432 191 419</b>	
<b>32.460</b> VF	12,8	338	D 2876 LF03 <V2400, Euro 3>		08.02-10.03		6	<b>0 432 191 416</b>	
<b>33.360</b> DA, DF	12,0	265	D 2866 LF24 <V2600, Euro 3>		09.02-06.03		6	<b>0 432 191 418</b> <sup>1</sup>	
							6	<b>0 432 191 419</b>	
<b>33.410</b> DA, DF	12,0	301	D 2866 LF25 <V2600, Euro 3>		09.02-06.03		6	<b>0 432 191 418</b> <sup>1</sup>	
							6	<b>0 432 191 419</b>	
<b>33.460</b> DA, DF	12,8	338	D 2876 LF03 <V2400, Euro 3>		09.02-06.03		6	<b>0 432 191 416</b>	
<b>35.360</b> VA, VF	12,0	265	D 2866 LF24 <V2600, Euro 3>		08.02-09.03		6	<b>0 432 191 418</b> <sup>1</sup>	
							6	<b>0 432 191 419</b>	
<b>35.410</b> VA, VF	12,0	301	D 2866 LF25 <V2600, Euro 3>		09.02-10.03		6	<b>0 432 191 418</b> <sup>1</sup>	
							6	<b>0 432 191 419</b>	
<b>35.460</b> VA, VF	12,8	338	D 2876 LF03 <V2400, Euro 3>		09.02-10.03		6	<b>0 432 191 416</b>	
<b>41.410</b> VA, VF	12,0	301	D 2866 LF25 <V2600, Euro 3>		09.02-09.03		6	<b>0 432 191 418</b> <sup>1</sup>	
							6	<b>0 432 191 419</b>	
<b>41.460</b> VA, VF	12,8	338	D 2876 LF03 <V2400, Euro 3>		09.02-09.03		6	<b>0 432 191 416</b>	
<b>50.410</b> FVN, VA, VF	12,0	301	D 2866 LF25 <V2600, Euro 3>		09.02-09.03		6	<b>0 432 191 418</b> <sup>1</sup>	
							6	<b>0 432 191 419</b>	
<b>50.460</b> FVN, VA, VF	12,8	338	D 2876 LF03 <V2400, Euro 3>		08.02-09.03		6	<b>0 432 191 416</b>	
<b>310A</b> DF, F, FA, VF	12,0	228	D 2866 LF23 <V2600, Euro 3>; D 2866 LF23 <V2600, Euro 3>		01.00-08.02		6	<b>0 432 191 418</b> <sup>1</sup>	
							6	<b>0 432 191 419</b>	
<b>360A</b> DA, DF, F, FA, F, FL, VA, VF	12,0	265	D 2866 LF24 <V2600, Euro 3>		01.00-09.02		6	<b>0 432 191 418</b> <sup>1</sup>	
							6	<b>0 432 191 419</b>	
<b>410A</b> DA, DF, F, FA, F, FL, FVA, FVF, FVN, VA, VF	12,0	301	D 2866 LF25 <V2600, Euro 3>		01.00-09.02		6	<b>0 432 191 418</b> <sup>1</sup>	
							6	<b>0 432 191 419</b>	
<b>460A</b> DA, DF	12,8	338	D 2876 LF03 <V2400, Euro 3>		01.00-04.00		6	<b>0 432 191 482</b> <sup>1</sup>	
					01.00-09.02		6	<b>0 432 191 416</b>	
F, FA, F, FL	12,8	338	D 2876 LF03 <V2400, Euro 3>		07.01-09.02		6	<b>0 432 191 416</b>	
FVN, VA, VF	12,8	338	D 2876 LF03 <V2400, Euro 3>		01.00-04.00		6	<b>0 432 191 482</b> <sup>1</sup>	
					01.00-09.02		6	<b>0 432 191 416</b>	
<b>F / HF</b>									
<b>292</b> F [881]	12,0	213-229	D 2866 TUH/290 <V0100>		03.86-02.94		6	<b>0 430 233 028</b>	
HF [883]	12,0	213-229	D 2866 TUH/290 <V0100>		03.86-02.94		6	<b>0 430 233 028</b>	
<b>332</b> F [881]	12,0	243	D 2866 LUH/330		09.85-04.94		6	<b>0 432 231 778</b>	<b>0 986 430 159</b>
HF [883]	12,0	243	D 2866 LUH/330		09.85-04.94		6	<b>0 432 231 778</b>	<b>0 986 430 159</b>
<b>362</b> F [881]	12,0	265	D 2866 KUH/360 <Z6400, Euro 1>		09.85-04.94		6	<b>0 432 231 778</b>	<b>0 986 430 159</b>
HF [883]	12,0	265	D 2866 KUH/360 <Z6400, Euro 1>		09.85-04.94		6	<b>0 432 231 778</b>	<b>0 986 430 159</b>
<b>F/M/U 90</b>									
<b>19.242</b> F, FL	12,0	177	D 2866 F/240		01.88-02.89		6	<b>0 432 231 751</b>	
<b>19.262</b> F, FA, FL	10,0	191	D 2865 LF/260 <V0700>		01.88-02.90		5	<b>0 430 233 028</b>	
<b>19.272</b> F, FA, FL	10,0	198	D 2865 LF02 <V0700>; D 2865 LF05 <V0700, Euro 1>		02.90-05.95		5	<b>0 432 131 831</b>	<b>0 986 430 228</b>
<b>19.292</b> F, FA, FL	12,0	213	D 2866 LF/290		07.86-02.90		6	<b>0 432 231 778</b>	<b>0 986 430 159</b>
<b>19.302</b> F, FA, FL	12,0	220	D 2866 LF04 <Z7601>		05.90-09.91		6	<b>0 432 231 778</b>	<b>0 986 430 159</b>
<b>19.322</b> F, FA, FL, U, UL	10,0	235	D 2865 LF03 <V0700>; D 2865 LF06 <V0700, Euro 1>		02.90-06.96		5	<b>0 432 131 831</b>	<b>0 986 430 228</b>















◀ MAN

<b>19.332</b> F, FA, FL, U, UL	12,0	243	D 2866 LF/330; D 2866 LUL/330	07.86-02.90	6	<b>0 432 231 778</b>	<b>0 986 430 159</b>
<b>19.342</b> F, FA, FL	10,0	250	D 2865 LF09 <V0700, Euro 2>	05.94-06.96	5	<b>0 432 131 734</b> <sup>1</sup>	
					5	<b>0 432 131 788</b>	<b>0 986 430 312</b>
<b>19.362</b> F, FL	12,0	265	D 2866 KF, LXF	07.86-12.87	6	<b>0 432 231 778</b>	<b>0 986 430 159</b>
				09.88-02.90	6	<b>0 432 131 853</b>	<b>0 986 430 196</b>
FA	12,0	265	D 2866 LXF <Z7600>	05.88-02.90	6	<b>0 432 131 853</b>	<b>0 986 430 196</b>
U, UL	12,0	265	D 2866 KUL/360 <Z5100, Euro 1>	07.86-01.91	6	<b>0 432 231 778</b>	<b>0 986 430 159</b>
<b>19.372</b> F, FA, FL, U, UL	12,0	249/272	D 2866 LF03 <Z7601>; D 2866 LF05 <Z7601, Euro 1>; D 2866 LF15 <Z7601, Euro 1>; D 2866 LXF/Silent	02.90-06.96	6	<b>0 432 131 853</b>	<b>0 986 430 196</b>
<b>19.402</b> F	12,0	294	D 2866 LF16 <Z7601, Euro 2>	05.94-12.95	6	<b>0 432 131 809</b> <sup>1</sup>	
				05.94-06.96	6	<b>0 432 131 788</b>	<b>0 986 430 312</b>
FA	12,0	294	D 2866 LF16 <Z7601, Euro 2>	05.94-12.95	6	<b>0 432 131 809</b> <sup>1</sup>	
				05.94-06.96	6	<b>0 432 131 788</b>	<b>0 986 430 312</b>
				01.96-06.96	6	<b>0 432 131 734</b> <sup>1</sup>	
FL	12,0	294	D 2866 LF16 <Z7601, Euro 2>	05.94-12.95	6	<b>0 432 131 809</b> <sup>1</sup>	
				05.94-06.96	6	<b>0 432 131 788</b>	<b>0 986 430 312</b>
<b>19.422</b> F, FA, FL, U, UL	12,0	309	D 2866 LF06 <Z7601>; D 2866 LF09 <Z7601, Euro 1>; D 2866 LF10 <Euro 1>	02.90-06.96	6	<b>0 432 131 831</b>	<b>0 986 430 228</b>
<b>19.462</b> F, FLS	18,3	338	D 2840 LF/460	05.87-02.90	10	<b>0 432 231 767</b>	
<b>19.502</b> F, FL	18,3	368	D 2840 LF01 <V0600,>; D 2840 LF04 <V0600, Euro 1>	02.90-06.96	10	<b>0 432 131 831</b>	<b>0 986 430 228</b>
<b>22.292</b> FNL	12,0	213	D 2866 LF/290	07.86-10.86	6	<b>0 432 231 778</b>	<b>0 986 430 159</b>
<b>22.332</b> FNL, UNL	12,0	243	D 2866 LF/330; D 2866 LUL/330	07.86-10.86	6	<b>0 432 231 778</b>	<b>0 986 430 159</b>
<b>22.362</b> FNL, UNL	12,0	265	D 2866 KF <Z7500>; D 2866 KUL/360 <Z5100, Euro 1>	07.86-10.86	6	<b>0 432 231 778</b>	<b>0 986 430 159</b>
<b>23.272</b> FNL	10,0	198	D 2865 LF05 <V0700, Euro 1>	10.92-05.95	5	<b>0 432 131 831</b>	<b>0 986 430 228</b>
<b>23.322</b> FNL	10,0	235	D 2865 LF06 <V0700, Euro 1>	10.92-05.95	5	<b>0 432 131 831</b>	<b>0 986 430 228</b>
<b>23.342</b> FNL	10,0	250	D 2865 LF09 <V0700, Euro 2>	05.94-05.95	5	<b>0 432 131 734</b> <sup>1</sup>	
					5	<b>0 432 131 788</b>	<b>0 986 430 312</b>
<b>23.372</b> FNL	12,0	272	D 2866 LF05 <Z7601, Euro 1>; D 2866 LF15 <Z7601, Euro 1>	10.92-05.95	6	<b>0 432 131 853</b>	<b>0 986 430 196</b>
<b>23.402</b> FNL	12,0	294	D 2866 LF16 <Z7601, Euro 2>	05.94-05.95	6	<b>0 432 131 788</b>	<b>0 986 430 312</b>
					6	<b>0 432 131 809</b> <sup>1</sup>	
<b>23.422</b> FNL	12,0	309	D 2866 LF09 <Z7601, Euro 1>	10.92-05.95	6	<b>0 432 131 831</b>	<b>0 986 430 228</b>
<b>24.192</b> FNL, FVL	6,9	140	D 0826 LF01 <Z9500>	07.89-10.92	6	<b>0 432 131 858</b>	
			D 0826 LF05 <Z9500, Euro 1>; D 0826 LF07 <Z9500, Euro 1>	07.93-06.96	6	<b>0 432 131 820</b>	<b>0 986 430 257</b>
<b>24.222</b> FNL, FVL	6,9	162	D 0826 LF11 <Z9500, Euro 2>	05.94-06.96	6	<b>0 432 133 855</b>	<b>0 986 430 313</b>
<b>24.232</b> FNL	6,9	160	D 0826 LF/217/Silent <Z9500>	05.90-04.92	6	<b>0 432 131 858</b>	
				07.93-04.95	6	<b>0 432 131 820</b>	<b>0 986 430 257</b>
FNL, FVL	6,9	169	D 0826 LF02 <Z9500>	07.89-10.92	6	<b>0 432 131 858</b>	
			D 0826 LF06 <Z9500, Euro 1>	07.93-05.94	6	<b>0 432 131 820</b>	<b>0 986 430 257</b>
			D 0826 LF08 <Z9500, Euro 1>	05.94-06.96	6	<b>0 432 131 820</b>	<b>0 986 430 257</b>
<b>24.242</b> DF, FNL, FVL	12,0	177	D 2866 F/240	01.88-02.90	6	<b>0 432 231 751</b>	
<b>24.262</b> DF, DFLS, FNL, FVL	10,0	191	D 2865 LF/260 <V0700>	01.88-02.90	5	<b>0 430 233 028</b>	
FNL, FVL	6,9	191	D 0826 LF13 <Z9500, Euro 2>	08.95-06.96	6	<b>0 432 133 840</b>	
					6	<b>0 432 133 841</b> <sup>1</sup>	
<b>24.272</b> DF, DFLS, FNL, FVL	10,0	198	D 2865 LF02 <V0700>	02.90-04.95	5	<b>0 432 131 831</b>	<b>0 986 430 228</b>
FNL, FVL	6,9	198	D 0826 LF04 <Z9500, Euro 1>	07.93-06.96	6	<b>0 432 131 820</b>	<b>0 986 430 257</b>
<b>24.292</b> DF, FNL, FVL	12,0	213	D 2866 LF/290	10.86-02.90	6	<b>0 432 231 778</b>	<b>0 986 430 159</b>
<b>24.302</b> DF, FNL, FVL	12,0	220	D 2866 LF04 <Z7601>	05.90-12.90	6	<b>0 432 231 778</b>	<b>0 986 430 159</b>
<b>24.322</b> DF, DFLS, FNL, FVL, UNL	10,0	235	D 2865 LF03 <V0700>	02.90-12.90	5	<b>0 432 131 831</b>	<b>0 986 430 228</b>
<b>24.332</b> DF, DFLS, FNL, FVL, UNL	12,0	243	D 2866 LF/330; D 2866 LUL/330	10.86-02.90	6	<b>0 432 231 778</b>	<b>0 986 430 159</b>
<b>24.362</b> DF, FNL, FVL	12,0	265	D 2866 KF, LXF	10.86-12.87	6	<b>0 432 231 778</b>	<b>0 986 430 159</b>
				09.88-02.90	6	<b>0 432 131 853</b>	<b>0 986 430 196</b>
DFLS	12,0	265	D 2866 LXF <Z7600>	07.89-02.90	6	<b>0 432 131 853</b>	<b>0 986 430 196</b>
UNL	12,0	265	D 2866 KUL/360 <Z5100, Euro 1>	10.86-02.90	6	<b>0 432 231 778</b>	<b>0 986 430 159</b>
<b>24.372</b> DF, FNL, FVL	12,0	249/272	D 2866 LF03 <Z7601>; D 2866 LXF/Silent	02.90-12.90	6	<b>0 432 131 853</b>	<b>0 986 430 196</b>
<b>24.422</b> DF, FNL, FVL	12,0	309	D 2866 LF06 <Z7601>	02.90-12.90	6	<b>0 432 131 831</b>	<b>0 986 430 228</b>
<b>24.462</b> DF, FNL	18,3	338	D 2840 LF/460	02.89-02.90	10	<b>0 432 231 767</b>	
FVLS	18,3	338	D 2840 LF/460	05.87-07.87	10	<b>0 432 231 767</b>	



										
<b>25.272</b> DF, DFL, FNL, FVL	10,0	198	D 2865 LF02 <V0700>; D 2865 LF05 <V0700, Euro 1>	09.90-10.93	5	<b>0 432 131 831</b>	<b>0 986 430 228</b>			
<b>25.302</b> DF, DFSL, FNL, FVL	12,0	220	D 2866 LF04 <Z7601>	09.90-12.91	6	<b>0 432 231 778</b>	<b>0 986 430 159</b>			
<b>25.322</b> DF, DFL, FNL, FVL, UNL	10,0	235	D 2865 LF03 <V0700>; D 2865 LF06 <V0700, Euro 1>	09.90-10.93	5	<b>0 432 131 831</b>	<b>0 986 430 228</b>			
<b>25.372</b> DF, DFL, FNL, FVL, UNL	12,0	249/272	D 2866 LF03 <Z7601>; D 2866 LF05 <Z7601, Euro 1>; D 2866 LXF/Silent	09.90-10.93	6	<b>0 432 131 853</b>	<b>0 986 430 196</b>			
<b>25.422</b> DF, DFL, FNL, FVL, UNL	12,0	309	D 2866 LF06 <Z7601>; D 2866 LF09 <Z7601, Euro 1>	09.90-10.93	6	<b>0 432 131 831</b>	<b>0 986 430 228</b>			
<b>25.502</b> DF, DFL, FNL	18,3	368	D 2840 LF01 <V0600,>; D 2840 LF04 <V0600, Euro 1>	09.90-12.92	10	<b>0 432 131 831</b>	<b>0 986 430 228</b>			
<b>26.242</b> DF, DFA	12,0	177	D 2866 F/240	01.88-07.89	6	<b>0 432 231 751</b>				
<b>26.262</b> DF, DFA	10,0	191	D 2865 LF/260 <V0700>	01.88-02.90	5	<b>0 430 233 028</b>				
<b>26.272</b> DF, DFA, DFL	10,0	198	D 2865 LF05 <V0700, Euro 1>	10.92-06.96	5	<b>0 432 131 831</b>	<b>0 986 430 228</b>			
DF, DFA, FVL	10,0	198	D 2865 LF02 <V0700>	02.90-10.92	5	<b>0 432 131 831</b>	<b>0 986 430 228</b>			
FNL	10,0	198	D 2865 LF05 <V0700, Euro 1>	03.91-07.92	5	<b>0 432 131 866</b>	<b>0 986 430 228</b>			
FVL	10,0	198	D 2865 LF05 <V0700, Euro 1>	08.92-06.96	5	<b>0 432 131 831</b>	<b>0 986 430 228</b>			
<b>26.292</b> DF, DFA	12,0	213	D 2866 LF/290	09.87-02.90	6	<b>0 432 231 778</b>	<b>0 986 430 159</b>			
<b>26.302</b> DF, DFA, FNL, FVL	12,0	220	D 2866 LF04 <Z7601>	05.90-12.91	6	<b>0 432 231 778</b>	<b>0 986 430 159</b>			
<b>26.322</b> DF, DFA, DFL, FNL, FVL, UNL	10,0	235	D 2865 LF03 <V0700>; D 2865 LF06 <V0700, Euro 1>; D 2865 LF06 <V0700, Euro 1Euro 1>	02.90-06.96	5	<b>0 432 131 831</b>	<b>0 986 430 228</b>			
<b>26.332</b> DF, DFA	12,0	243	D 2866 LF/330	09.87-02.90	6	<b>0 432 231 778</b>	<b>0 986 430 159</b>			
<b>26.342</b> DF, DFL, FNL, FVL	10,0	250	D 2865 LF09 <V0700, Euro 2>	05.94-06.96	5	<b>0 432 131 734</b> <sup>1</sup>				
					5	<b>0 432 131 788</b>	<b>0 986 430 312</b>			
<b>26.362</b> DF	12,0	265	D 2866 KF, LXF	09.87-12.87	6	<b>0 432 231 778</b>	<b>0 986 430 159</b>			
DFA	12,0	265	D 2866 LXF <Z7600>	09.88-02.90	6	<b>0 432 131 853</b>	<b>0 986 430 196</b>			
<b>26.372</b> DF, DFA, DFL, FNL, FVL, UNL	12,0	249/272	D 2866 LF03 <Z7601>; D 2866 LF05 <Z7601, Euro 1>; D 2866 LF15 <Z7601, Euro 1>; D 2866 LXF/Silent	02.90-06.96	6	<b>0 432 131 853</b>	<b>0 986 430 196</b>			
<b>26.402</b> DF, DFL	12,0	294	D 2866 LF16 <Z7601, Euro 2>	05.94-12.95	6	<b>0 432 131 809</b> <sup>1</sup>				
				05.94-06.96	6	<b>0 432 131 788</b>	<b>0 986 430 312</b>			
				01.96-06.96	6	<b>0 432 131 734</b> <sup>1</sup>				
FNL, FVL	12,0	294	D 2866 LF16 <Z7601, Euro 2>	05.94-12.95	6	<b>0 432 131 809</b> <sup>1</sup>				
				05.94-06.96	6	<b>0 432 131 788</b>	<b>0 986 430 312</b>			
<b>26.422</b> DF, DFA, DFL, FNL, FVL, UNL	12,0	309	D 2866 LF06 <Z7601>; D 2866 LF09 <Z7601, Euro 1>	02.90-06.96	6	<b>0 432 131 831</b>	<b>0 986 430 228</b>			
<b>26.462</b> DF, DFA	18,3	338	D 2840 LF/460	02.89-02.90	10	<b>0 432 231 767</b>				
<b>26.502</b> DF, DFA, DFSL, FNL	18,3	368	D 2840 LF01 <V0600,>; D 2840 LF04 <V0600, Euro 1>	02.90-06.96	10	<b>0 432 131 831</b>	<b>0 986 430 228</b>			
<b>32.272</b> VF	10,0	198	D 2865 LF05 <V0700, Euro 1>	10.92-04.95	5	<b>0 432 131 831</b>	<b>0 986 430 228</b>			
<b>32.322</b> VF	10,0	235	D 2865 LF06 <V0700, Euro 1>	10.92-06.96	5	<b>0 432 131 831</b>	<b>0 986 430 228</b>			
<b>32.342</b> VF	10,0	250	D 2865 LF09 <V0700, Euro 2>	05.94-06.96	5	<b>0 432 131 734</b> <sup>1</sup>				
					5	<b>0 432 131 788</b>	<b>0 986 430 312</b>			
<b>32.372</b> VF	12,0	272	D 2866 LF05 <Z7601, Euro 1>; D 2866 LF15 <Z7601, Euro 1>	10.92-06.96	6	<b>0 432 131 853</b>	<b>0 986 430 196</b>			
<b>32.402</b> VF	12,0	294	D 2866 LF16 <Z7601, Euro 2>	05.94-12.95	6	<b>0 432 131 809</b> <sup>1</sup>				
				05.94-06.96	6	<b>0 432 131 788</b>	<b>0 986 430 312</b>			
				01.96-06.96	6	<b>0 432 131 734</b> <sup>1</sup>				
<b>32.422</b> VF	12,0	309	D 2866 LF09 <Z7601, Euro 1>	10.92-06.96	6	<b>0 432 131 831</b>	<b>0 986 430 228</b>			
<b>33.242</b> DF	12,0	177	D 2866 F/240	01.88-08.88	6	<b>0 432 231 751</b>				
<b>33.262</b> DF, DFA	10,0	191	D 2865 LF/260 <V0700>	01.88-02.90	5	<b>0 430 233 028</b>				
<b>33.272</b> DF, DFA	10,0	198	D 2865 LF05 <V0700, Euro 1>	10.92-04.95	5	<b>0 432 131 831</b>	<b>0 986 430 228</b>			
<b>33.292</b> DF, DFA	12,0	213	D 2866 LF/290	09.87-02.90	6	<b>0 432 231 778</b>	<b>0 986 430 159</b>			
<b>33.322</b> DF, DFA	10,0	235	D 2865 LF03 <V0700>; D 2865 LF06 <V0700, Euro 1>	09.91-06.96	5	<b>0 432 131 831</b>	<b>0 986 430 228</b>			
<b>33.332</b> DF, DFA	12,0	243	D 2866 LF/330	09.87-02.90	6	<b>0 432 231 778</b>	<b>0 986 430 159</b>			
<b>33.342</b> DF, DFA	10,0	250	D 2865 LF09 <V0700, Euro 2>	05.94-06.96	5	<b>0 432 131 734</b> <sup>1</sup>				
					5	<b>0 432 131 788</b>	<b>0 986 430 312</b>			
<b>33.362</b> DF	12,0	265	D 2866 KF, LXF	09.87-12.87	6	<b>0 432 231 778</b>	<b>0 986 430 159</b>			
				09.88-02.90	6	<b>0 432 131 853</b>	<b>0 986 430 196</b>			















◀ MAN

<b>33.362</b> DFA	12,0	265	D 2866 LXF <Z7600>	05.88-02.90	6	<b>0 432 131 853</b>	<b>0 986 430 196</b>	
<b>33.372</b> DF, DFA	12,0	272	D 2866 LF03 <Z7601>; D 2866 LF05 <Z7601, Euro 1>; D 2866 LF15 <Z7601, Euro 1>	09.91-06.96	6	<b>0 432 131 853</b>	<b>0 986 430 196</b>	
<b>33.402</b> DF, DFA	12,0	294	D 2866 LF16 <Z7601, Euro 2>	05.94-12.95	6	<b>0 432 131 809</b> <sup>1</sup>		
				05.94-06.96	6	<b>0 432 131 788</b>	<b>0 986 430 312</b>	
				01.96-06.96	6	<b>0 432 131 734</b> <sup>1</sup>		
<b>33.422</b> DF, DFA	12,0	309	D 2866 LF06 <Z7601>; D 2866 LF09 <Z7601, Euro 1>	09.91-06.96	6	<b>0 432 131 831</b>	<b>0 986 430 228</b>	
<b>33.462</b> DF, DFA	18,3	338	D 2840 LF/460	07.89-02.90	10	<b>0 432 231 767</b>		
<b>33.502</b> DF, DFA	18,3	368	D 2840 LF01 <V0600,>; D 2840 LF04 <V0600, Euro 1>	09.91-06.96	10	<b>0 432 131 831</b>	<b>0 986 430 228</b>	
<b>35.262</b> VF, VFA	10,0	191	D 2865 LF/260 <V0700>	02.89-02.90	5	<b>0 430 233 028</b>		
<b>35.292</b> VF, VFA	12,0	213	D 2866 LFZ/290 <Z6700>	10.88-04.95	6	<b>0 432 231 778</b>	<b>0 986 430 159</b>	
<b>35.322</b> VF, VFAK	10,0	235	D 2865 LF03 <V0700>; D 2865 LF06 <V0700, Euro 1>	02.90-06.96	5	<b>0 432 131 831</b>	<b>0 986 430 228</b>	
<b>35.332</b> VF, VFA	12,0	243	D 2866 LFZ/330 <Z6700>	10.88-04.95	6	<b>0 432 231 778</b>	<b>0 986 430 159</b>	
<b>35.342</b> VF, VFAK	10,0	250	D 2865 LF09 <V0700, Euro 2>	05.94-06.96	5	<b>0 432 131 734</b> <sup>1</sup>		
					5	<b>0 432 131 788</b>	<b>0 986 430 312</b>	
<b>35.362</b> VF, VFA	12,0	265	D 2866 LXF <Z7600>	10.88-02.90	6	<b>0 432 131 853</b>	<b>0 986 430 196</b>	
<b>35.372</b> VF, VFAK	12,0	272	D 2866 LF03 <Z7601>; D 2866 LF05 <Z7601, Euro 1>; D 2866 LF15 <Z7601, Euro 1>	02.90-06.96	6	<b>0 432 131 853</b>	<b>0 986 430 196</b>	
<b>35.402</b> VF, VFAK	12,0	294	D 2866 LF16 <Z7601, Euro 2>	05.94-12.95	6	<b>0 432 131 809</b> <sup>1</sup>		
				05.94-06.96	6	<b>0 432 131 788</b>	<b>0 986 430 312</b>	
				01.96-06.96	6	<b>0 432 131 734</b> <sup>1</sup>		
<b>35.422</b> VF, VFAK	12,0	309	D 2866 LF06 <Z7601>; D 2866 LF09 <Z7601, Euro 1>	02.90-06.96	6	<b>0 432 131 831</b>	<b>0 986 430 228</b>	
<b>FR / FRH</b>								
<b>352</b> F [A33]	12,0	257	D 2866 LOH26 <V1500, Euro 2>	07.98-09.01	6	<b>0 432 131 631</b> <sup>1</sup>		
					6	<b>0 432 131 633</b>		
					6	<b>0 432 131 633</b>		
<b>402</b> F [A33]	12,0	294	D 2866 LOH23 <V1500, Euro 2>	07.98-09.01	6	<b>0 432 131 734</b> <sup>1</sup>		
					6	<b>0 432 131 788</b>	<b>0 986 430 312</b>	
					6	<b>0 432 131 788</b>	<b>0 986 430 312</b>	
<b>FR-FRH</b>								
<b>292</b>	12,0	213-224	D 2866 TUH/290 <V0100>	05.85-04.92	6	<b>0 430 233 028</b>		
		229	D 2866 TOH/310 <Z7900>	03.91-12.92	6	<b>0 432 231 778</b>	<b>0 986 430 159</b>	
<b>352</b>	12,0	257	D 2866 LOH26 <V1500, Euro 2>	09.95-11.99	6	<b>0 432 131 631</b> <sup>1</sup>		
					6	<b>0 432 131 633</b>		
<b>362</b>	12,0	265	D 2866 KUH/360 <Z6400, Euro 1>	05.85-12.92	6	<b>0 432 231 778</b>	<b>0 986 430 159</b>	
<b>402</b>	12,0	294	D 2866 LOH23 <V1500, Euro 2>	09.95-11.99	6	<b>0 432 131 734</b> <sup>1</sup>		
					6	<b>0 432 131 788</b>	<b>0 986 430 312</b>	
<b>F90</b>								
<b>32.262</b> VF	10,0	191	D 2865 LF/260 <V0700>	02.89-02.90	5	<b>0 430 233 028</b>		
<b>32.272</b> VF	10,0	198	D 2865 LF02 <V0700>	02.90-05.94	5	<b>0 432 131 831</b>	<b>0 986 430 228</b>	
<b>32.292</b> VF	12,0	213	D 2866 LF/290	03.88-02.90	6	<b>0 432 231 778</b>	<b>0 986 430 159</b>	
<b>32.302</b> VF	12,0	220	D 2866 LF04 <Z7601>	05.90-09.91	6	<b>0 432 231 778</b>	<b>0 986 430 159</b>	
<b>32.322</b> VF	10,0	235	D 2865 LF03 <V0700>	02.90-05.94	5	<b>0 432 131 831</b>	<b>0 986 430 228</b>	
<b>32.332</b> VF	12,0	243	D 2866 LF/330	03.88-02.90	6	<b>0 432 231 778</b>	<b>0 986 430 159</b>	
<b>32.362</b> VF	12,0	265	D 2866 LXF <Z7600>	03.88-02.90	6	<b>0 432 131 853</b>	<b>0 986 430 196</b>	
<b>32.372</b> VF	12,0	249/272	D 2866 LF03 <Z7601>; D 2866 LXF/Silent	02.90-04.95	6	<b>0 432 131 853</b>	<b>0 986 430 196</b>	
<b>32.422</b> VF	12,0	309	D 2866 LF06 <Z7601>	02.90-05.94	6	<b>0 432 131 831</b>	<b>0 986 430 228</b>	
<b>35.272</b> VF	10,0	198	D 2865 LF02 <V0700>	02.90-12.91	5	<b>0 432 131 831</b>	<b>0 986 430 228</b>	
<b>35.302</b> VF, VFA	12,0	220	D 2866 LF04 <Z7601>	05.90-09.91	6	<b>0 432 231 778</b>	<b>0 986 430 159</b>	
<b>35.322</b> VF	10,0	235	D 2865 LF03 <V0700>	02.90-05.94	5	<b>0 432 131 831</b>	<b>0 986 430 228</b>	
<b>35.372</b> VF	12,0	249/272	D 2866 LF03 <Z7601>; D 2866 LXF/Silent	02.90-04.95	6	<b>0 432 131 853</b>	<b>0 986 430 196</b>	
<b>35.422</b> VF	12,0	309	D 2866 LF06 <Z7601>	02.90-05.94	6	<b>0 432 131 831</b>	<b>0 986 430 228</b>	
<b>F2000</b>								
<b>17.373</b> DF	12,0	272	D 2866 LF21 <V2600, Euro 1>	01.94-12.00	6	<b>0 432 131 853</b>	<b>0 986 430 196</b>	
<b>19.273</b> F, FA, FL	10,0	198	D 2865 LF22 <V2500, Euro 1>	01.94-03.97	5	<b>0 432 131 831</b>	<b>0 986 430 228</b>	



										
<b>19.293</b> F, FA, FL	10,0	213	D 2865 LF24 <V2500, Euro 2>	04.95-01.00	5	<b>0 432 131 633</b>				
<b>19.314</b> F, FAS/FAC/FAK, FLL, FLLS/FLLC/FLCW, FLS/FLK/FLC	12,0	228	D 2866 LF34 <V2600, Euro 2>	06.98-12.01	6	<b>0 432 131 631</b> <sup>1</sup>				
					6	<b>0 432 131 633</b>				
<b>19.320</b> FA	10,0	235	D 2865 LF23 <V2500, Euro 1>	01.94-12.95	5	<b>0 432 131 831</b>	<b>0 986 430 228</b>			
<b>19.323</b> F, FL	10,0	235	D 2865 LF23 <V2500, Euro 1>	01.94-12.95	5	<b>0 432 131 831</b>	<b>0 986 430 228</b>			
<b>19.343</b> F, FA, FL	10,0	250	D 2865 LF21 <V2500, Euro 2>	01.94-01.00	5	<b>0 432 131 734</b> <sup>1</sup>				
					5	<b>0 432 131 788</b>	<b>0 986 430 312</b>			
<b>19.364</b> F, FA, FL, FLL	12,0	265	D 2866 LF35 <V2600, Euro 2>	06.98-12.01	6	<b>0 432 131 631</b> <sup>1</sup>				
					6	<b>0 432 131 633</b>				
<b>19.373</b> F, FA, FL	12,0	272	D 2866 LF21 <V2600, Euro 1>	01.94-12.95	6	<b>0 432 131 853</b>	<b>0 986 430 196</b>			
<b>19.403</b> F, FA, FL	12,0	294	D 2866 LF20 <V2600, Euro 2>	01.94-12.01	6	<b>0 432 131 734</b> <sup>1</sup>				
					6	<b>0 432 131 788</b>	<b>0 986 430 312</b>			
<b>19.414</b> F, FA, FL, FLL	12,0	301	D 2866 LF31 <V2600, Euro 2>	03.00-12.01	6	<b>0 432 191 416</b>				
				05.00-12.01	6	<b>0 432 191 415</b> <sup>1</sup>				
FLL	12,0	301	D 2866 LF25 <V2600, Euro 3>	01.00-12.01	6	<b>0 432 191 418</b> <sup>1</sup>				
					6	<b>0 432 191 419</b>				
<b>19.423</b> F, FA, FL	12,0	309	D 2866 LF22 <V2600, Euro 1>	01.94-12.95	6	<b>0 432 131 831</b>	<b>0 986 430 228</b>			
<b>19.463</b> F, FA, FL	12,8	338	D 2876 LF02 <V2400, Euro 2>	01.94-09.95	6	<b>0 432 131 759</b> <sup>1</sup>				
				01.94-12.01	6	<b>0 432 131 760</b>	<b>0 986 430 451</b>			
				10.95-12.01	6	<b>0 432 131 733</b> <sup>1</sup>				
<b>19.464</b> F, FA, FL, FLL, FLL-P, FLLR-P	12,8	338	D 2876 LF06 <V2400, Euro 2>	06.98-01.00	6	<b>0 432 191 483</b>				
				06.98-04.00	6	<b>0 432 191 482</b> <sup>1</sup>				
				02.00-07.01	6	<b>0 432 191 416</b>				
				05.00-07.01	6	<b>0 432 191 415</b> <sup>1</sup>				
FLL, FLL-P, FLLR-P	12,8	338	D 2876 LF03 <V2400, Euro 3>	01.00-04.00	6	<b>0 432 191 482</b> <sup>1</sup>				
				01.00-12.02	6	<b>0 432 191 416</b>				
<b>19.603</b> FL	18,3	441	D 2840 LF20 <V3400, Euro 2>	04.96-02.99	10	<b>0 432 133 839</b>				
<b>23.293</b>	10,0	213	D 2865 LF24 <V2500, Euro 2>	04.95-01.00	5	<b>0 432 131 633</b>				
<b>23.314</b> FNLC	12,0	228	D 2866 LF34 <V2600, Euro 2>	07.99-09.01	6	<b>0 432 131 631</b> <sup>1</sup>				
					6	<b>0 432 131 633</b>				
FNLLC, FNLLC/L	12,0	228	D 2866 LF23 <V2600, Euro 3>	01.00-12.02	6	<b>0 432 191 418</b> <sup>1</sup>				
					6	<b>0 432 191 419</b>				
<b>23.343</b>	10,0	250	D 2865 LF21 <V2500, Euro 2>	01.94-01.00	5	<b>0 432 131 734</b> <sup>1</sup>				
					5	<b>0 432 131 788</b>	<b>0 986 430 312</b>			
<b>23.364</b> FNLC	12,0	265	D 2866 LF35 <V2600, Euro 2>	07.99-09.01	6	<b>0 432 131 631</b> <sup>1</sup>				
					6	<b>0 432 131 633</b>				
FNLLC, FNLLC/L	12,0	265	D 2866 LF24 <V2600, Euro 3>	01.00-12.02	6	<b>0 432 191 418</b> <sup>1</sup>				
					6	<b>0 432 191 419</b>				
<b>23.403</b> FNL	12,0	294	D 2866 LF20 <V2600, Euro 2>	01.94-09.01	6	<b>0 432 131 734</b> <sup>1</sup>				
					6	<b>0 432 131 788</b>	<b>0 986 430 312</b>			
<b>23.414</b> FNLC	12,0	301	D 2866 LF31 <V2600, Euro 2>	03.00-12.01	6	<b>0 432 191 416</b>				
				05.00-12.01	6	<b>0 432 191 415</b> <sup>1</sup>				
FNLLC, FNLLC/L	12,0	301	D 2866 LF25 <V2600, Euro 3>	01.00-12.02	6	<b>0 432 191 418</b> <sup>1</sup>				
					6	<b>0 432 191 419</b>				
<b>23.463</b> FNL	12,8	338	D 2876 LF02 <V2400, Euro 2>	01.94-09.95	6	<b>0 432 131 759</b> <sup>1</sup>				
				01.94-09.01	6	<b>0 432 131 760</b>	<b>0 986 430 451</b>			
				10.95-09.01	6	<b>0 432 131 733</b> <sup>1</sup>				
<b>23.464</b> FNLC	12,8	338	D 2876 LF06 <V2400, Euro 2>	07.99-01.00	6	<b>0 432 191 483</b>				
				07.99-04.00	6	<b>0 432 191 482</b> <sup>1</sup>				
				02.00-09.01	6	<b>0 432 191 416</b>				
				05.00-09.01	6	<b>0 432 191 415</b> <sup>1</sup>				
FNLLC, FNLLC/L	12,8	338	D 2876 LF03 <V2400, Euro 3>	01.00-04.00	6	<b>0 432 191 482</b> <sup>1</sup>				
				01.00-12.02	6	<b>0 432 191 416</b>				
<b>24.273</b> FNL	10,0	198	D 2865 LF22 <V2500, Euro 1>	01.94-12.95	5	<b>0 432 131 831</b>	<b>0 986 430 228</b>			
<b>24.293</b> FNL	10,0	213	D 2865 LF24 <V2500, Euro 2>	01.94-01.00	5	<b>0 432 131 633</b>				
<b>24.314</b> FNLLRC	12,0	228	D 2866 LF23 <V2600, Euro 3>	01.00-08.02	6	<b>0 432 191 418</b> <sup>1</sup>				
					6	<b>0 432 191 419</b>				
			D 2866 LF34 <V2600, Euro 2>	07.99-09.01	6	<b>0 432 131 631</b> <sup>1</sup>				
					6	<b>0 432 131 633</b>				
<b>24.323</b> FNL	10,0	235	D 2865 LF23 <V2500, Euro 1>	01.94-12.95	5	<b>0 432 131 831</b>	<b>0 986 430 228</b>			
<b>24.343</b> FNL	10,0	250	D 2865 LF21 <V2500, Euro 2>	01.94-01.00	5	<b>0 432 131 734</b> <sup>1</sup>				
					5	<b>0 432 131 788</b>	<b>0 986 430 312</b>			















◀ MAN

<b>24.364</b> FNLLRC	12,0	265	D 2866 LF35 <V2600, Euro 2>	07.99-09.01	6	<b>0 432 131 631</b> <sup>1</sup>	
					6	<b>0 432 131 633</b>	
<b>24.373</b> FNL	12,0	272	D 2866 LF21 <V2600, Euro 1>	01.94-12.95	6	<b>0 432 131 853</b>	<b>0 986 430 196</b>
<b>24.403</b> FNL	12,0	294	D 2866 LF20 <V2600, Euro 2>	01.94-09.01	6	<b>0 432 131 734</b> <sup>1</sup>	
					6	<b>0 432 131 788</b>	<b>0 986 430 312</b>
<b>24.414</b> FNLLRC	12,0	301	D 2866 LF31 <V2600, Euro 2>	03.00-12.01	6	<b>0 432 191 416</b>	
				05.00-12.01	6	<b>0 432 191 415</b> <sup>1</sup>	
<b>24.423</b> FNL	12,0	309	D 2866 LF22 <V2600, Euro 1>	01.94-12.95	6	<b>0 432 131 831</b>	<b>0 986 430 228</b>
<b>24.463</b> FNL	12,8	338	D 2876 LF02 <V2400, Euro 2>	01.94-09.95	6	<b>0 432 131 759</b> <sup>1</sup>	
				01.94-09.01	6	<b>0 432 131 760</b>	<b>0 986 430 451</b>
				10.95-09.01	6	<b>0 432 131 733</b> <sup>1</sup>	
<b>24.464</b> FNLLRC	12,8	338	D 2876 LF06 <V2400, Euro 2>	07.99-01.00	6	<b>0 432 191 483</b>	
				07.99-04.00	6	<b>0 432 191 482</b> <sup>1</sup>	
				02.00-09.01	6	<b>0 432 191 416</b>	
				05.00-09.01	6	<b>0 432 191 415</b> <sup>1</sup>	
<b>26.273</b> DF, DFL, FNL, FVL	10,0	198	D 2865 LF22 <V2500, Euro 1>	01.94-12.95	5	<b>0 432 131 831</b>	<b>0 986 430 228</b>
<b>26.293</b> DF, DFL, FNL, FVL	10,0	213	D 2865 LF24 <V2500, Euro 2>	04.95-01.00	5	<b>0 432 131 633</b>	
<b>26.314</b> DFL, DFS/DFK/DF-TM/DFC, FNLLC/FNLLW, FNLS/FNLC, FVL	12,0	228	D 2866 LF34 <V2600, Euro 2>	07.99-06.02	6	<b>0 432 131 631</b> <sup>1</sup>	
					6	<b>0 432 131 633</b>	
	12,0	228	D 2866 LF23 <V2600, Euro 3>	12.00-06.02	6	<b>0 432 191 418</b> <sup>1</sup>	
					6	<b>0 432 191 419</b>	
<b>26.323</b> DF, DFL, FNL, FVL	10,0	235	D 2865 LF23 <V2500, Euro 1>	01.94-12.95	5	<b>0 432 131 831</b>	<b>0 986 430 228</b>
<b>26.343</b> DF, DFL, FNL, FVL	10,0	250	D 2865 LF21 <V2500, Euro 2>	01.94-01.00	5	<b>0 432 131 734</b> <sup>1</sup>	
					5	<b>0 432 131 788</b>	<b>0 986 430 312</b>
<b>26.364</b> DF, DFL, FNL, FNLL, FVL	12,0	265	D 2866 LF35 <V2600, Euro 2>	07.99-06.02	6	<b>0 432 131 631</b> <sup>1</sup>	
					6	<b>0 432 131 633</b>	
<b>26.373</b> DF, DFL, FNL, FVL	12,0	272	D 2866 LF21 <V2600, Euro 1>	01.94-12.95	6	<b>0 432 131 853</b>	<b>0 986 430 196</b>
<b>26.403</b> DF, DFL, FNL, FVL	12,0	294	D 2866 LF20 <V2600, Euro 2>	01.94-09.01	6	<b>0 432 131 734</b> <sup>1</sup>	
					6	<b>0 432 131 788</b>	<b>0 986 430 312</b>
<b>26.414</b> DFL, DFS/DFK/DF-TM/DFC, FNL, FNLLC/FNLLW, FVL	12,0	301	D 2866 LF31 <V2600, Euro 2>	03.00-06.02	6	<b>0 432 191 416</b>	
				05.00-06.02	6	<b>0 432 191 415</b> <sup>1</sup>	
<b>26.423</b> DF, DFL, FNL, FVL	12,0	309	D 2866 LF22 <V2600, Euro 1>	01.94-12.95	6	<b>0 432 131 831</b>	<b>0 986 430 228</b>
<b>26.463</b> DF, DFL, FNL, FVL	12,8	338	D 2876 LF02 <V2400, Euro 2>	01.94-09.95	6	<b>0 432 131 759</b> <sup>1</sup>	
				01.94-09.01	6	<b>0 432 131 760</b>	<b>0 986 430 451</b>
				10.95-09.01	6	<b>0 432 131 733</b> <sup>1</sup>	
<b>26.464</b> DF, DFL, FNL, FNLL, FVL	12,8	338	D 2876 LF06 <V2400, Euro 2>	07.99-01.00	6	<b>0 432 191 483</b>	
				07.99-04.00	6	<b>0 432 191 482</b> <sup>1</sup>	
				02.00-06.02	6	<b>0 432 191 416</b>	
				05.00-06.02	6	<b>0 432 191 415</b> <sup>1</sup>	
<b>26.603</b> DFL	18,3	441	D 2840 LF20 <V3400, Euro 2>	06.96-02.99	10	<b>0 432 133 839</b>	
<b>27.273</b> DF, DFA	10,0	198	D 2865 LF22 <V2500, Euro 1>	01.94-12.95	5	<b>0 432 131 831</b>	<b>0 986 430 228</b>
<b>27.293</b> DF, DFA	10,0	213	D 2865 LF24 <V2500, Euro 2>	04.95-01.00	5	<b>0 432 131 633</b>	
<b>27.314</b> DF, DFA	12,0	228	D 2866 LF34 <V2600, Euro 2>	07.99-09.01	6	<b>0 432 131 631</b> <sup>1</sup>	
					6	<b>0 432 131 633</b>	
<b>27.323</b> DF, DFA	10,0	235	D 2865 LF23 <V2500, Euro 1>	01.94-12.95	5	<b>0 432 131 831</b>	<b>0 986 430 228</b>
<b>27.343</b> DF, DFA	10,0	250	D 2865 LF21 <V2500, Euro 2>	01.94-01.00	5	<b>0 432 131 734</b> <sup>1</sup>	
					5	<b>0 432 131 788</b>	<b>0 986 430 312</b>
<b>27.364</b> DF, DFA	12,0	265	D 2866 LF35 <V2600, Euro 2>	07.99-09.01	6	<b>0 432 131 631</b> <sup>1</sup>	
					6	<b>0 432 131 633</b>	
<b>27.373</b> DF, DFA	12,0	272	D 2866 LF21 <V2600, Euro 1>	01.94-12.95	6	<b>0 432 131 853</b>	<b>0 986 430 196</b>
<b>27.403</b> DFA, DFC	12,0	294	D 2866 LF20 <V2600, Euro 2>	01.94-09.01	6	<b>0 432 131 734</b> <sup>1</sup>	
					6	<b>0 432 131 788</b>	<b>0 986 430 312</b>
<b>27.414</b> DF, DFA	12,0	301	D 2866 LF31 <V2600, Euro 2>	03.00-12.01	6	<b>0 432 191 416</b>	
				05.00-12.01	6	<b>0 432 191 415</b> <sup>1</sup>	
<b>27.423</b> DF, DFA	12,0	309	D 2866 LF22 <V2600, Euro 1>	01.94-12.95	6	<b>0 432 131 831</b>	<b>0 986 430 228</b>
<b>27.463</b> DF, DFA	12,8	338	D 2876 LF02 <V2400, Euro 2>	01.94-09.95	6	<b>0 432 131 759</b> <sup>1</sup>	
				01.94-09.01	6	<b>0 432 131 760</b>	<b>0 986 430 451</b>
				10.95-09.01	6	<b>0 432 131 733</b> <sup>1</sup>	
<b>27.464</b> DF, DFA	12,8	338	D 2876 LF06 <V2400, Euro 2>	07.99-01.00	6	<b>0 432 191 483</b>	
				07.99-04.00	6	<b>0 432 191 482</b> <sup>1</sup>	
				02.00-09.01	6	<b>0 432 191 416</b>	
				05.00-09.01	6	<b>0 432 191 415</b> <sup>1</sup>	
<b>27.603</b> DF, DFA	18,3	441	D 2840 LF20 <V3400, Euro 2>	06.96-02.99	10	<b>0 432 133 839</b>	



									
32.293 VF	10,0	213	D 2865 LF24 <V2500, Euro 2>	08.95-01.00			5	<b>0 432 131 633</b>	
32.314 VF-TM	12,0	228	D 2866 LF34 <V2600, Euro 2>	07.99-09.01			6	<b>0 432 131 631</b> <sup>1</sup>	
							6	<b>0 432 131 633</b>	
32.343 VF	10,0	250	D 2865 LF21 <V2500, Euro 2>	08.95-01.00			5	<b>0 432 131 734</b> <sup>1</sup>	
							5	<b>0 432 131 788</b>	<b>0 986 430 312</b>
32.364 VF	12,0	265	D 2866 LF35 <V2600, Euro 2>	07.99-09.01			6	<b>0 432 131 631</b> <sup>1</sup>	
							6	<b>0 432 131 633</b>	
32.403 VF	12,0	294	D 2866 LF20 <V2600, Euro 2>	08.95-09.01			6	<b>0 432 131 734</b> <sup>1</sup>	
							6	<b>0 432 131 788</b>	<b>0 986 430 312</b>
32.414 VF	12,0	301	D 2866 LF31 <V2600, Euro 2>	03.00-12.01			6	<b>0 432 191 416</b>	
				05.00-12.01			6	<b>0 432 191 415</b> <sup>1</sup>	
32.463 VF	12,8	338	D 2876 LF02 <V2400, Euro 2>	08.95-09.01			6	<b>0 432 131 760</b>	<b>0 986 430 451</b>
				10.95-09.01			6	<b>0 432 131 733</b> <sup>1</sup>	
32.464 VF	12,8	338	D 2876 LF06 <V2400, Euro 2>	07.99-01.00			6	<b>0 432 191 483</b>	
				07.99-04.00			6	<b>0 432 191 482</b> <sup>1</sup>	
				02.00-09.01			6	<b>0 432 191 416</b>	
				05.00-09.01			6	<b>0 432 191 415</b> <sup>1</sup>	
33.323 DF, DFA	10,0	235	D 2865 LF23 <V2500, Euro 1>	01.94-12.95			5	<b>0 432 131 831</b>	<b>0 986 430 228</b>
33.343 DF, DFA	10,0	250	D 2865 LF21 <V2500, Euro 2>	01.94-01.00			5	<b>0 432 131 734</b> <sup>1</sup>	
							5	<b>0 432 131 788</b>	<b>0 986 430 312</b>
33.364 DF, DFA	12,0	265	D 2866 LF35 <V2600, Euro 2>	07.99-09.01			6	<b>0 432 131 631</b> <sup>1</sup>	
							6	<b>0 432 131 633</b>	
33.373 , DF, DFA	12,0	272	D 2866 LF21 <V2600, Euro 1>	01.94-12.00			6	<b>0 432 131 853</b>	<b>0 986 430 196</b>
33.374 K/L	12,0	272	D 2866 LF21 <V2600, Euro 1>	01.01-→			6	<b>0 432 131 853</b>	<b>0 986 430 196</b>
33.403 DF, DFA	12,0	294	D 2866 LF20 <V2600, Euro 2>	01.94-09.01			6	<b>0 432 131 734</b> <sup>1</sup>	
							6	<b>0 432 131 788</b>	<b>0 986 430 312</b>
33.414 DF	12,0	301	D 2866 LF31 <V2600, Euro 2>	03.00-12.01			6	<b>0 432 191 416</b>	
				05.00-12.01			6	<b>0 432 191 415</b> <sup>1</sup>	
33.423 DF, DFA	12,0	309	D 2866 LF22 <V2600, Euro 1>	01.94-12.95			6	<b>0 432 131 831</b>	<b>0 986 430 228</b>
33.463 DF, DFA	12,8	338	D 2876 LF02 <V2400, Euro 2>	01.94-09.95			6	<b>0 432 131 759</b> <sup>1</sup>	
				01.94-09.01			6	<b>0 432 131 760</b>	<b>0 986 430 451</b>
				10.95-09.01			6	<b>0 432 131 733</b> <sup>1</sup>	
33.464 DF	12,8	338	D 2876 LF06 <V2400, Euro 2>	07.99-01.00			6	<b>0 432 191 483</b>	
				07.99-04.00			6	<b>0 432 191 482</b> <sup>1</sup>	
				02.00-09.01			6	<b>0 432 191 416</b>	
				05.00-09.01			6	<b>0 432 191 415</b> <sup>1</sup>	
33.603 DF, DFA	18,3	441	D 2840 LF20 <V3400, Euro 2>	06.96-02.99			10	<b>0 432 133 839</b>	
35.343 VF	10,0	250	D 2865 LF21 <V2500, Euro 2>	08.95-01.00			5	<b>0 432 131 734</b> <sup>1</sup>	
							5	<b>0 432 131 788</b>	<b>0 986 430 312</b>
35.364 VF	12,0	265	D 2866 LF35 <V2600, Euro 2>	07.99-09.01			6	<b>0 432 131 631</b> <sup>1</sup>	
							6	<b>0 432 131 633</b>	
35.403 VF	12,0	294	D 2866 LF20 <V2600, Euro 2>	08.95-09.01			6	<b>0 432 131 734</b> <sup>1</sup>	
							6	<b>0 432 131 788</b>	<b>0 986 430 312</b>
35.414 VF	12,0	301	D 2866 LF31 <V2600, Euro 2>	03.00-12.01			6	<b>0 432 191 416</b>	
				05.00-12.01			6	<b>0 432 191 415</b> <sup>1</sup>	
35.463 VF	12,8	338	D 2876 LF02 <V2400, Euro 2>	08.95-09.01			6	<b>0 432 131 760</b>	<b>0 986 430 451</b>
				10.95-09.01			6	<b>0 432 131 733</b> <sup>1</sup>	
35.464 VF	12,8	338	D 2876 LF06 <V2400, Euro 2>	07.99-01.00			6	<b>0 432 191 483</b>	
				07.99-04.00			6	<b>0 432 191 482</b> <sup>1</sup>	
				02.00-09.01			6	<b>0 432 191 416</b>	
				05.00-09.01			6	<b>0 432 191 415</b> <sup>1</sup>	
40.414 DFA, DFK	12,0	301	D 2866 LF31 <V2600, Euro 2>	03.00-12.01			6	<b>0 432 191 416</b>	
				05.00-12.01			6	<b>0 432 191 415</b> <sup>1</sup>	
40.464 DFA, DFK	12,8	338	D 2876 LF06 <V2400, Euro 2>	12.97-01.00			6	<b>0 432 191 483</b>	
				12.97-04.00			6	<b>0 432 191 482</b> <sup>1</sup>	
				02.00-09.01			6	<b>0 432 191 416</b>	
				05.00-09.01			6	<b>0 432 191 415</b> <sup>1</sup>	
41.343 VF	10,0	250	D 2865 LF21 <V2500, Euro 2>	08.95-01.00			5	<b>0 432 131 734</b> <sup>1</sup>	
							5	<b>0 432 131 788</b>	<b>0 986 430 312</b>
41.364 VF	12,0	265	D 2866 LF35 <V2600, Euro 2>	07.99-09.01			6	<b>0 432 131 631</b> <sup>1</sup>	
							6	<b>0 432 131 633</b>	
41.403 VF	12,0	294	D 2866 LF20 <V2600, Euro 2>	08.95-09.01			6	<b>0 432 131 734</b> <sup>1</sup>	
							6	<b>0 432 131 788</b>	<b>0 986 430 312</b>





◀ MAN

41.414 VF	12,0	301	D 2866 LF31 <V2600, Euro 2>	03.00-09.01	6	0 432 191 416	
				05.00-09.01	6	0 432 191 415 <sup>1</sup>	
41.463 VF	12,8	338	D 2876 LF02 <V2400, Euro 2>	08.95-09.01	6	0 432 131 760	0 986 430 451
				10.95-09.01	6	0 432 131 733 <sup>1</sup>	
41.464 VF	12,8	338	D 2876 LF06 <V2400, Euro 2>	07.99-01.00	6	0 432 191 483	
				07.99-04.00	6	0 432 191 482 <sup>1</sup>	
				02.00-09.01	6	0 432 191 416	
				05.00-09.01	6	0 432 191 415 <sup>1</sup>	

**F2000 Evol. (FE)**

26.310 DF	12,0	228	D 2866 LF23 <V2600, Euro 3>	09.02-06.03	6	0 432 191 418 <sup>1</sup>	
					6	0 432 191 419	
26.360 DF	12,0	265	D 2866 LF24 <V2600, Euro 3>	09.02-06.03	6	0 432 191 418 <sup>1</sup>	
					6	0 432 191 419	
35.310 VF	12,0	228	D 2866 LF23 <V2600, Euro 3>	09.02-09.03	6	0 432 191 418 <sup>1</sup>	
					6	0 432 191 419	
35.410 VF	12,0	301	D 2866 LF25 <V2600, Euro 3>	09.02-06.03	6	0 432 191 418 <sup>1</sup>	
					6	0 432 191 419	
310A DA, DF, F, FA, F, FL, VF	12,0	228	D 2866 LF23 <V2600, Euro 3>	07.99-08.02	6	0 432 191 418 <sup>1</sup>	
					6	0 432 191 419	
360A DA, DF, F, FA, F, FL, VF	12,0	265	D 2866 LF24 <V2600, Euro 3>	07.99-09.02	6	0 432 191 418 <sup>1</sup>	
					6	0 432 191 419	
410A DA, DF, F, FA, VF	12,0	301	D 2866 LF25 <V2600, Euro 3>	07.99-09.02	6	0 432 191 418 <sup>1</sup>	
					6	0 432 191 419	
460A DA, DF, F, FA, VF	12,8	338	D 2876 LF03 <V2400, Euro 3>	01.00-04.00	6	0 432 191 482 <sup>1</sup>	
				01.00-09.02	6	0 432 191 416	

**Lion's City**









NG 263	12,0	191	D 2866 LUH23 <V5000, Euro 3>	01.01-09.06	6	0 432 191 417 <sup>1</sup>	
					6	0 432 191 419	
263, 313, 353	12,0	191/228/ 258	D 2866 LUH21 <V3200, Euro 2>; D 2866 LUH22 <V3200, Euro 2>; D 2866 LUH26 <V3200, Euro 2>	07.98-12.01	6	0 432 131 631 <sup>1</sup>	
					6	0 432 131 633	
313	12,0	228	D 2866 LUH24 <V5000, Euro 3>	01.01-09.06	6	0 432 191 417 <sup>1</sup>	
					6	0 432 191 419	
363	12,0	265	D 2866 LUH25 <V5000, Euro 3>	01.01-09.06	6	0 432 191 417 <sup>1</sup>	
					6	0 432 191 419	

**Lion's City / NL**

NL 202 [A10]	6,9	157	D 0826 LUH03 <V0300, Euro 1>	08.92-03.97	6	0 432 131 820	0 986 430 257				
					[895]	6,9	157	D 0826 LUH/213 <V0300, >	09.89-04.93	6	0 432 131 820
NL 222 [A10]	6,9	162	D 0826 LUH12 <V0300, Euro 2>	11.95-11.99	6	0 432 133 841 <sup>1</sup>					
					6	0 432 133 842 <sup>1</sup>					
F [898]	6,9	162	D 0826 LUH12 <V0300, Euro 2>	02.96-09.01	6	0 432 133 842 <sup>1</sup>					
					6	0 432 133 855	0 986 430 313				
NL 223 [A21]	6,9	162	D 0826 LUH12 <V0300, Euro 2>	07.98-09.01	6	0 432 133 842 <sup>1</sup>					
					6	0 432 133 855	0 986 430 313				
F [A22]	6,9	162	D 0826 LUH02 <V4600, Euro 3>	01.01-06.05	6	0 432 133 798					
					6	0 432 133 842 <sup>1</sup>					
D 0836 LUH02 <V4600, Euro 3>	6,9	162	D 0826 LUH12 <V0300, Euro 2>	02.96-09.01	6	0 432 133 855	0 986 430 313				
					6	0 432 133 798					
NL 243 [A21]	12,0	191	D 2866 LUH23 <V5000, Euro 3>	01.02-09.06	6	0 432 191 417 <sup>1</sup>					
					6	0 432 191 419					
NL 262 [A10]	6,9	191	D 0826 LUH13 <V0300, Euro 2>	02.96-11.99	6	0 432 133 840					
					6	0 432 133 841 <sup>1</sup>					
					10,0	191	D 2865 LUH09 <V1400, Euro 2>	06.97-07.98	5	0 432 131 633	
					12,0	191	D 2866 LUH22 <V3200, Euro 2>	07.98-11.99	6	0 432 131 631 <sup>1</sup>	
F [898]	6,9	191	D 0826 LUH13 <V0300, Euro 2>	02.96-09.01	6	0 432 133 840					
					6	0 432 133 841 <sup>1</sup>					
NL 263 [A21]	6,9	191	D 0826 LUH13 <V0300, Euro 2>	07.98-09.01	6	0 432 133 840					
					6	0 432 133 841 <sup>1</sup>					
D 2866 LUH22 <V3200, Euro 2>	12,0	191	D 2866 LUH22 <V3200, Euro 2>	07.98-09.01	6	0 432 131 631 <sup>1</sup>					
					6	0 432 131 633					





										
<b>NL 263 F</b> [A22]	6,9	191	D 0826 LUH13 <V0300, Euro 2>	07.98-09.01	6	<b>0 432 133 840</b>				
					6	<b>0 432 133 841</b> <sup>1</sup>				
	12,0	191	D 2866 LUH22 <V3200, Euro 2>	07.98-09.01	6	<b>0 432 131 631</b> <sup>1</sup>				
					6	<b>0 432 131 633</b>				
			D 2866 LUH23 <V5000, Euro 3>	07.98-09.01	6	<b>0 432 191 417</b> <sup>1</sup>				
				03.00-09.01	6	<b>0 432 191 419</b>				
F [A30]	12,0	191	D 2866 LUH22 <V3200, Euro 2>	11.99-09.01	6	<b>0 432 131 631</b> <sup>1</sup>				
					6	<b>0 432 131 633</b>				
			D 2866 LUH23 <V5000, Euro 3>	01.01-09.02	6	<b>0 432 191 417</b> <sup>1</sup>				
					6	<b>0 432 191 419</b>				
<b>NL 283</b> [A21]	6,9	206	D 0836 LUH01 <V4600, Euro 3>	01.01-09.06	6	<b>0 432 133 766</b>				
F [A22]	6,9	206	D 0836 LUH01 <V4600, Euro 3>	01.01-09.06	6	<b>0 432 133 766</b>				
<b>NL 312</b> [A10]	10,0	228	D 2865 LUH07 <V1400, Euro 2>	11.95-07.98	5	<b>0 432 131 733</b> <sup>1</sup>				
					5	<b>0 432 131 760</b>	<b>0 986 430 451</b>			
F [898]	10,0	228	D 2865 LUH07 <V1400, Euro 2>	02.96-09.01	5	<b>0 432 131 733</b> <sup>1</sup>				
					5	<b>0 432 131 760</b>	<b>0 986 430 451</b>			
<b>NL 313</b> [A21]	12,0	228	D 2866 LUH24 <V5000, Euro 3>	01.01-09.06	6	<b>0 432 191 417</b> <sup>1</sup>				
					6	<b>0 432 191 419</b>				
			D 2866 LUH26 <V3200, Euro 2>	07.98-12.01	6	<b>0 432 131 631</b> <sup>1</sup>				
					6	<b>0 432 131 633</b>				
F [A22]	12,0	228	D 2866 LUH24 <V5000, Euro 3>	01.01-09.06	6	<b>0 432 191 417</b> <sup>1</sup>				
					6	<b>0 432 191 419</b>				
			D 2866 LUH26 <V3200, Euro 2>	07.98-12.01	6	<b>0 432 131 631</b> <sup>1</sup>				
					6	<b>0 432 131 633</b>				
F [A30]	12,0	228	D 2866 LUH24 <V5000, Euro 3>	01.01-03.06	6	<b>0 432 191 417</b> <sup>1</sup>				
					6	<b>0 432 191 419</b>				
			D 2866 LUH26 <V3200, Euro 2>	11.99-09.02	6	<b>0 432 131 631</b> <sup>1</sup>				
					6	<b>0 432 131 633</b>				
<b>NL 353 F</b> [A30]	12,0	258	D 2866 LUH21 <V3200, Euro 2>	11.99-09.01	6	<b>0 432 131 631</b> <sup>1</sup>				
					6	<b>0 432 131 633</b>				
<b>NL 363 F</b> [A30]	12,0	265	D 2866 LUH25 <V5000, Euro 3>	01.01-03.06	6	<b>0 432 191 417</b> <sup>1</sup>				
					6	<b>0 432 191 419</b>				
<b>Lion's City DD / ND</b>										
<b>ND 222 F</b> [A14]	6,9	162	D 0826 LUH12 <V0300, Euro 2>	06.97-09.01	6	<b>0 432 133 842</b> <sup>1</sup>				
					6	<b>0 432 133 855</b>	<b>0 986 430 313</b>			
<b>ND 313</b> [A39]	12,0	228	D 2866 LUH51 <Euro4>	08.03→	6	<b>0 432 191 249</b> <sup>1</sup>				
					6	<b>0 432 191 250</b>				
<b>Lion's City LL / NL</b>										
<b>NL 263</b> [A26]	12,0	191	D 2866 LUH22 <V3200, Euro 2>	08.98-09.01	6	<b>0 432 131 631</b> <sup>1</sup>				
					6	<b>0 432 131 633</b>				
			D 2866 LUH23 <V5000, Euro 3>	01.01-09.02	6	<b>0 432 191 417</b> <sup>1</sup>				
					6	<b>0 432 191 419</b>				
<b>NL 313</b> [A26]	12,0	228	D 2866 LUH24 <V5000, Euro 3>	01.01-09.06	6	<b>0 432 191 417</b> <sup>1</sup>				
					6	<b>0 432 191 419</b>				
			D 2866 LUH26 <V3200, Euro 2>	08.98-12.01	6	<b>0 432 131 631</b> <sup>1</sup>				
					6	<b>0 432 131 633</b>				
<b>NL 353</b> [A26]	12,0	257	D 2866 LUH21 <V3200, Euro 2>	08.98-12.01	6	<b>0 432 131 631</b> <sup>1</sup>				
					6	<b>0 432 131 633</b>				
<b>NL 363</b> [A26]	12,0	265	D 2866 LUH25 <V5000, Euro 3>	01.01-09.06	6	<b>0 432 191 417</b> <sup>1</sup>				
					6	<b>0 432 191 419</b>				
<b>Lion's City M / NM</b>										
[A47]	6,9	162	D 0836 LOH03 <V4900, Euro 3>	04.04-09.06	6	<b>0 432 133 765</b>				
<b>NM 11.222</b> [469]	6,9	162	D 0826 LOH15 <V2900,>	02.96-07.98	6	<b>0 432 133 855</b>	<b>0 986 430 313</b>			
<b>NM 11.223</b> [469]	6,9	162	D 0826 LOH15 <V2900,>	07.98-09.01	6	<b>0 432 133 855</b>	<b>0 986 430 313</b>			
<b>NM 152</b> [A05]	4,6	114	D 0824 LOH01 <V1900, Euro 1>	08.91-05.96	4	<b>0 432 131 820</b>	<b>0 986 430 257</b>			
<b>NM 222 F</b> [A35]	6,9	162	D 0826 LUH12 <V0300, Euro 2>	06.97-09.01	6	<b>0 432 133 842</b> <sup>1</sup>				
					6	<b>0 432 133 855</b>	<b>0 986 430 313</b>			
<b>NM 223 F</b> [A35]	6,9	162	D 0836 LOH03 <V4900, Euro 3>	01.00-05.01	6	<b>0 432 133 799</b> <sup>1</sup>				
				01.00-09.06	6	<b>0 432 133 765</b>				
<b>NM 283 F</b> [A35]	6,9	206	D 0836 LOH02 <V4900, Euro 3>	10.01-09.06	6	<b>0 432 133 766</b>				
<b>Lion's City T,TÜ / EL</b>										
[A78]	6,9	162	D 0836 LOH03 <V4900, Euro 3>	06.04-09.06	6	<b>0 432 133 765</b>				
		206	D 0836 LOH02 <V4900, Euro 3>	06.04-09.06	6	<b>0 432 133 766</b>				





◀ MAN

Lion's City Ü / NÜ							
NÜ 263 [A20]	6,9	191	D 0826 LUH13 <V0300, Euro 2>	07.98-09.01	6	0 432 133 840	
					6	0 432 133 841 <sup>1</sup>	
	10,0	191	D 2865 LUH09 <V1400, Euro 2>	09.96-07.98	5	0 432 131 633	
	12,0	191	D 2866 LUH22 <V3200, Euro 2>	07.98-09.01	6	0 432 131 631 <sup>1</sup>	
					6	0 432 131 633	
			D 2866 LUH23 <V5000, Euro 3>	01.01-09.06	6	0 432 191 417 <sup>1</sup>	
					6	0 432 191 419	
NÜ 283 [A20]	6,9	206	D 0836 LUH01 <V4600, Euro 3>	01.01-09.06	6	0 432 133 766	
NÜ 313 [A20]	12,0	228	D 2866 LUH24 <V5000, Euro 3>	01.01-09.06	6	0 432 191 417 <sup>1</sup>	
					6	0 432 191 419	
			D 2866 LUH26 <V3200, Euro 2>	07.98-12.01	6	0 432 131 631 <sup>1</sup>	
					6	0 432 131 633	
Lion's City ÜLL / NÜ							
NÜ 313 [A25]	12,0	228	D 2866 LUH24 <V5000, Euro 3>	02.98-09.06	6	0 432 191 417 <sup>1</sup>	
				03.00-09.06	6	0 432 191 419	
			D 2866 LUH26 <V3200, Euro 2>	02.98-12.01	6	0 432 131 631 <sup>1</sup>	
					6	0 432 131 633	
NÜ 353 [A25]	12,0	257	D 2866 LUH21 <V3200, Euro 2>	02.98-12.01	6	0 432 131 631 <sup>1</sup>	
					6	0 432 131 633	
NÜ 363 [A25]	12,0	265	D 2866 LUH25 <V5000, Euro 3>	01.01-09.06	6	0 432 191 417 <sup>1</sup>	
					6	0 432 191 419	
Lion's Classic							
SG 263	12,0	191	D 2866 LUH23 <V5000, Euro 3>	06.03-09.06	6	0 432 191 417 <sup>1</sup>	
					6	0 432 191 419	
313	12,0	228	D 2866 LUH24 <V5000, Euro 3>	06.03-09.06	6	0 432 191 417 <sup>1</sup>	
					6	0 432 191 419	
Lion's Classic / SL							
SL 223 [A74]	6,9	162	D 0836 LOH03 <V4900, Euro 3>	06.03-10.06	6	0 432 133 765	
SL 283 [A74]	6,9	206	D 0836 LOH02 <V4900, Euro 3>	06.03-09.06	6	0 432 133 766	
Lion's Coach							
C, L	12,0	301	D 2866 LOH34 <V4800, Euro 3>	09.02-09.06	6	0 432 191 417 <sup>1</sup>	
					6	0 432 191 419	
	12,8	338	D 2876 LOH03 <V4500, Euro 3>	09.02-09.06	6	0 432 191 414 <sup>1</sup>	
					6	0 432 191 416	
RHC 414	12,0	301	D 2866 LOH34 <V4800, Euro 3>	09.02-09.06	6	0 432 191 417 <sup>1</sup>	
					6	0 432 191 419	
464	12,8	338	D 2876 LOH03 <V4500, Euro 3>	09.02-09.06	6	0 432 191 414 <sup>1</sup>	
					6	0 432 191 416	
Lion's Comfort							
R 313 [A01]	12,0	228	D 2866 LUH26 <V3200, Euro 2>	01.98-12.01	6	0 432 131 631 <sup>1</sup>	
					6	0 432 131 633	
ÜL 313 [A01, A04]	12,0	228	D 2866 LUH26 <V3200, Euro 2>	05.99-12.01	6	0 432 131 631 <sup>1</sup>	
					6	0 432 131 633	
ÜL 353 [A01]	12,0	257	D 2866 LUH21 <V3200, Euro 2>	01.98-12.01	6	0 432 131 631 <sup>1</sup>	
					6	0 432 131 633	
Lion's Regio ÜL							
ÜL 314 [R12, R14]	12,0	228	D 2866 LUH24 <V5000, Euro 3>	06.04-09.06	6	0 432 191 417 <sup>1</sup>	
ÜL 364 [R13]	12,0	265	D 2866 LUH25 <V5000, Euro 3>	06.04-09.06	6	0 432 191 417 <sup>1</sup>	
					6	0 432 191 419	
Lion's Star							
FRH 422	12,0	309	D 2866 LOH20 <V1500, Euro 1>	01.93-09.96	6	0 432 131 831	0 986 430 228
			D 2866 LOH21 <V1500, Euro 1>	01.93-02.95	6	0 432 131 831	0 986 430 228
RH 352	12,0	257	D 2866 LOH26 <V1500, Euro 2>	07.98-09.01	6	0 432 131 631 <sup>1</sup>	
					6	0 432 131 633	
402	12,0	294	D 2866 LOH23 <V1500, Euro 2>	07.98-09.01	6	0 432 131 734 <sup>1</sup>	
					6	0 432 131 788	0 986 430 312
463	12,8	338	D 2876 LOH01 <V3300, Euro 2>	06.99-09.01	6	0 432 131 733 <sup>1</sup>	
					6	0 432 131 760	0 986 430 451
RHS 414	12,0	301	D 2866 LOH34 <V4800, Euro 3>	10.01-09.06	6	0 432 191 417 <sup>1</sup>	
					6	0 432 191 419	
464	12,0	338	D 2876 LOH03 <V4500, Euro 3>	10.01-09.06	6	0 432 191 414 <sup>1</sup>	
					6	0 432 191 416	





<b>Lion's Star L</b>						
RHS 414	12,0	301	D 2866 LOH34 <V4800, Euro 3>	10.01-09.06	6	<b>0 432 191 417</b> <sup>1</sup>
					6	<b>0 432 191 419</b>
464	12,0	338	D 2876 LOH03 <V4500, Euro 3>	10.01-09.06	6	<b>0 432 191 414</b> <sup>1</sup>
					6	<b>0 432 191 416</b>
<b>Lion's Top Coach</b>						
RH 403	12,0	294	D 2866 LOH23 <V1500, Euro 2>	06.99-01.04	6	<b>0 432 131 734</b> <sup>1</sup>
					6	<b>0 432 131 788 0 986 430 312</b>
463	12,8	339	D 2876 LOH01 <V3300, Euro 2>	06.99-01.04	6	<b>0 432 131 733</b> <sup>1</sup>
					6	<b>0 432 131 760 0 986 430 451</b>
<b>Lion's Top Star</b>						
RHS 414	12,0	301	D 2866 LOH34 <V4800, Euro 3>	01.02-09.06	6	<b>0 432 191 417</b> <sup>1</sup>
					6	<b>0 432 191 419</b>
464	12,8	338	D 2876 LOH03 <V4500, Euro 3>	01.02-09.06	6	<b>0 432 191 414</b> <sup>1</sup>
					6	<b>0 432 191 416</b>
<b>L2000</b>						
<b>8.103</b> F, FL, L, LL	4,6	75	D 0824 FL01 <V1800, Euro 1>	10.93-06.96	4	<b>0 432 133 872</b>
<b>8.113</b> L, LL	4,6	81	D 0824 LFL04 <V1700, Euro 2>	08.95-03.97	4	<b>0 432 131 746</b>
		83	D 0824 LFL08 <V1700, Euro 2>	03.97-09.01	4	<b>0 432 131 702</b>
<b>8.153</b> F, FL, L, LA, LL	4,6	114	D 0824 LFL01 <V1700, Euro 1>; D 0824 LFL05 <V1700, Euro 1>	10.93-07.97	4	<b>0 432 131 820 0 986 430 257</b>
<b>8.163</b> F, FL, L, LA, LL	4,6	114/118	D 0824 LFL02 <V1700, Euro 2>; D 0824 LFL06 <V1700, Euro 2>	05.94-03.97	4	<b>0 432 133 855 0 986 430 313</b>
L, LA, LL	4,6	104	D 0824 LFL07 <V1700, Euro 2>	08.95-03.97	4	<b>0 432 133 855 0 986 430 313</b>
				08.95-03.01	4	<b>0 432 133 855 0 986 430 313</b>
		114	D 0824 LFL09 <V1700, Euro 2>	03.97-03.01	4	<b>0 432 131 820 0 986 430 257</b>
				03.97-02.02	4	<b>0 432 131 820 0 986 430 257</b>
<b>8.185</b> L, LL	4,6	132	D 0834 LFL03 <V4400, Euro 3>	09.00-08.02	4	<b>0 432 133 765</b>
					4	<b>0 432 133 799</b> <sup>1</sup>
<b>8.223</b> F, FL, L, LA, LL	6,9	162	D 0826 LFL06 <V2300, Euro 1>	05.94-06.96	6	<b>0 432 131 820 0 986 430 257</b>
<b>8.224</b> F, FL, L, LA, LL	6,9	162	D 0826 LFL03 <V2300, Euro 2>	05.94-01.95	6	<b>0 432 133 855 0 986 430 313</b>
				05.94-09.01	6	<b>0 432 133 855 0 986 430 313</b>
L, LC, LK, L-KI, LK-LV, LLC, LLS	6,9	162	D 0826 LFL10 <V2300, Euro2>	07.94-09.01	6	<b>0 432 131 820 0 986 430 257</b>
<b>9.153</b> F, FL, L, LL	4,6	114	D 0824 LFL01 <V1700, Euro 1>; D 0824 LFL05 <V1700, Euro 1>	10.93-06.96	4	<b>0 432 131 820 0 986 430 257</b>
<b>9.163</b> F, FL, L, LL	4,6	104/114/ 118	D 0824 LFL02 <V1700, Euro 2>; D 0824 LFL06 <V1700, Euro 2>; D 0824 LFL07 <V1700, Euro 2>	05.94-03.97	4	<b>0 432 133 855 0 986 430 313</b>
L, LL	4,6	114	D 0824 LFL09 <V1700, Euro 2>	03.97-09.01	4	<b>0 432 131 820 0 986 430 257</b>
<b>9.185</b> L	4,6	132	D 0834 LFL03 <V4400, Euro 3>	09.00-08.02	4	<b>0 432 133 765</b>
					4	<b>0 432 133 799</b> <sup>1</sup>
<b>9.223</b> F, FL, L, LL	6,9	162	D 0826 LFL06 <V2300, Euro 1>	05.94-06.96	6	<b>0 432 131 820 0 986 430 257</b>
<b>9.224</b> F, FL, L, LL	6,9	162	D 0826 LFL03 <V2300, Euro 2>	05.94-01.95	6	<b>0 432 133 855 0 986 430 313</b>
				05.94-09.01	6	<b>0 432 133 855 0 986 430 313</b>
LC, L-KI, LLC, LLS	6,9	162	D 0826 LFL10 <V2300, Euro2>	07.94-03.01	6	<b>0 432 131 820 0 986 430 257</b>
				07.94-09.01	6	<b>0 432 131 820 0 986 430 257</b>
LK, LK-LV	0,0	162	D 0826 LFL10 <V2300, Euro2>	07.94-09.01	6	<b>0 432 131 820 0 986 430 257</b>
<b>10.145</b> L	4,6	103	D 0834 LFL02 <V4400, Euro 3>	07.01-06.02	4	<b>0 432 133 765</b>
					4	<b>0 432 133 799</b> <sup>1</sup>
<b>10.153</b> F, FL, L, LA, LL	4,6	114	D 0824 LFL01 <V1700, Euro 1>; D 0824 LFL05 <V1700, Euro 1>	10.93-06.96	4	<b>0 432 131 820 0 986 430 257</b>
<b>10.160</b> LA	4,6	114	D 0824 LFL09 <V1700, Euro 2>	03.97-09.06	4	<b>0 432 131 820 0 986 430 257</b>
<b>10.163</b> F, FL, L, LA, LL	4,6	114/118	D 0824 LFL02 <V1700, Euro 2>; D 0824 LFL06 <V1700, Euro 2>	05.94-03.97	4	<b>0 432 133 855 0 986 430 313</b>
L, LA, LL	4,6	114	D 0824 LFL09 <V1700, Euro 2>	03.97→	4	<b>0 432 131 820 0 986 430 257</b>
<b>10.223</b> F, F, FL, FL, L, LA	6,9	162	D 0826 LFL06 <V2300, Euro 1>	05.94-06.96	6	<b>0 432 131 820 0 986 430 257</b>
<b>10.224</b> F, F, FL, FL, L, LA	6,9	162	D 0826 LFL03 <V2300, Euro 2>	05.94-09.01	6	<b>0 432 133 855 0 986 430 313</b>
F, FL, LA, LC, LK, LK-L	6,9	162	D 0826 LFL10 <V2300, Euro 2>; D 0826 LFL10 <V2300, Euro2>	07.98-12.06	6	<b>0 432 131 820 0 986 430 257</b>
<b>12.163</b> L, LL	4,6	114	D 0824 LFL06 <V1700, Euro 2>	08.95-03.97	4	<b>0 432 133 855 0 986 430 313</b>
			D 0824 LFL09 <V1700, Euro 2>	03.97-08.01	4	<b>0 432 131 820 0 986 430 257</b>
<b>12.224</b> L, LL	6,9	162	D 0826 LFL03 <V2300, Euro 2>	08.95-03.97	6	<b>0 432 133 855 0 986 430 313</b>
			D 0826 LFL10 <V2300, Euro 2>	03.97-09.01	6	<b>0 432 131 820 0 986 430 257</b>





◀ MAN

<b>14.163 L, LL</b>	4,6	114	D 0824 LFL06 <V1700, Euro 2> D 0824 LFL09 <V1700, Euro 2>	08.95-03.97 03.97-08.01	4 4	<b>0 432 133 855</b> <b>0 986 430 313</b>	<b>0 432 131 820</b> <b>0 986 430 257</b>
<b>14.224 L, LA, LL</b>	6,9	162	D 0826 LFL03 <V2300, Euro 2> D 0826 LFL10 <V2300, Euro 2>	08.95-03.97 03.97-09.01	6 6	<b>0 432 133 855</b> <b>0 432 131 820</b>	<b>0 986 430 313</b> <b>0 986 430 257</b>
<b>14.264 L, LA, LL</b>	6,9	191	D 0826 LFL09 <V2300, Euro 2>	08.95-09.01	6 6	<b>0 432 133 840</b> <b>0 432 133 841<sup>1</sup></b>	
<b>15.163 L, LL</b>	4,6	114	D 0824 LFL06 <V1700, Euro 2> D 0824 LFL09 <V1700, Euro 2>	08.95-03.97 03.97-09.01	4 4	<b>0 432 133 855</b> <b>0 432 131 820</b>	<b>0 986 430 313</b> <b>0 986 430 257</b>
<b>15.224 L, LL</b>	6,9	162	D 0826 LFL03 <V2300, Euro 2> D 0826 LFL10 <V2300, Euro 2>; D 0826 LF10 <V2300, Euro 2>	08.95-03.97 03.97→	6 6	<b>0 432 133 855</b> <b>0 432 131 820</b>	<b>0 986 430 313</b> <b>0 986 430 257</b>
<b>15.264 L, LL</b>	6,9	191	D 0826 LFL09 <V2300, Euro 2>	08.95-09.01	6 6	<b>0 432 133 840</b> <b>0 432 133 841<sup>1</sup></b>	
<b>18.224 L, LA, LL</b>	6,9	162	D 0826 LFL03 <V2300, Euro 2> D 0826 LFL10 <V2300, Euro 2>	08.95-03.97 03.97-09.01	6 6	<b>0 432 133 855</b> <b>0 432 131 820</b>	<b>0 986 430 313</b> <b>0 986 430 257</b>
<b>18.264 L, LA, LL</b>	6,9	191	D 0826 LFL09 <V2300, Euro 2>	08.95-09.01	6 6	<b>0 432 133 840</b> <b>0 432 133 841<sup>1</sup></b>	
<b>20.224 L, LL</b>	6,9	162	D 0826 LFL10 <V2300, Euro 2>	10.97-09.01	6	<b>0 432 131 820</b>	<b>0 986 430 257</b>
<b>20.264 L, LL</b>	6,9	191	D 0826 LFL09 <V2300, Euro 2>	10.97-09.01	6 6	<b>0 432 133 840</b> <b>0 432 133 841<sup>1</sup></b>	



**L2000 Evol. (LE)**

<b>8.140 F, FL</b>	4,6	103	D 0834 LFL02 <V4400, Euro 3>	09.02-08.04	4 4	<b>0 432 133 765</b> <b>0 432 133 799<sup>1</sup></b>	
<b>8.150 F, FL</b>	4,6	110	D 0834 LFL04 <V4400, Euro 3>	06.04-12.05	4 4	<b>0 432 133 765</b> <b>0 432 133 799<sup>1</sup></b>	
<b>8.180 F, FL</b>	4,6	132	D 0834 LFL03 <V4400, Euro 3>	09.02-12.05	4 4	<b>0 432 133 765</b> <b>0 432 133 799<sup>1</sup></b>	
<b>8.220 F, FL</b>	6,9	162	D 0836 LFL02 <V3900, Euro 3>	09.02-12.05	6	<b>0 432 133 765</b>	
<b>9.140 F, FL</b>	4,6	103	D 0834 LFL02 <V4400, Euro 3>	09.02-08.04	4 4	<b>0 432 133 765</b> <b>0 432 133 799<sup>1</sup></b>	
<b>9.150 F, FL</b>	4,6	110	D 0834 LFL04 <V4400, Euro 3>	06.04-06.05	4 4	<b>0 432 133 765</b> <b>0 432 133 799<sup>1</sup></b>	
<b>9.180 F, FL</b>	4,6	132	D 0834 LFL03 <V4400, Euro 3>	09.02-06.05	4 4	<b>0 432 133 765</b> <b>0 432 133 799<sup>1</sup></b>	
<b>9.220 F, FL</b>	6,9	162	D 0836 LFL02 <V3900, Euro 3>	09.02-06.05	6	<b>0 432 133 765</b>	
<b>10.150 F, FL</b>	4,6	110	D 0834 LFL04 <V4400, Euro 3>	06.04-06.05	4 4	<b>0 432 133 765</b> <b>0 432 133 799<sup>1</sup></b>	
<b>10.180 F, FA, F, FL</b>	4,6	132	D 0834 LFL03 <V4400, Euro 3>	09.02-10.06	4 4	<b>0 432 133 765</b> <b>0 432 133 799<sup>1</sup></b>	
<b>10.220 F, FA, F, FL</b>	6,9	162	D 0836 LFL02 <V3900, Euro 3>	09.02-12.06	6	<b>0 432 133 765</b>	
<b>140C F, FL</b>	4,6	103	D 0834 LFL02 <V4400, Euro 3>	07.01-08.02	4 4	<b>0 432 133 765</b> <b>0 432 133 799<sup>1</sup></b>	
<b>160B F, FL</b>	4,6	114	D 0824 LFL06 <V1700, Euro 2>	09.00-09.01	4	<b>0 432 133 855</b>	<b>0 986 430 313</b>
<b>160C F, FL</b>	4,6	114	D 0824 LFL06 <V1700, Euro 2>	09.00-09.01	4	<b>0 432 133 855</b>	<b>0 986 430 313</b>
<b>180C F, FA, F, FL</b>	4,6	132	D 0834 LFL03 <V4400, Euro 3>	09.00-08.02	4 4	<b>0 432 133 765</b> <b>0 432 133 799<sup>1</sup></b>	
<b>220C F, FA, F, FL</b>	6,9	162	D 0826 LFL10 <V2300, Euro 2> D 0836 LFL02 <V3900, Euro 3>	09.00-01.02 07.01-02.02 07.01-08.02	6 6 6	<b>0 432 131 820</b> <b>0 432 133 799<sup>1</sup></b> <b>0 432 133 765</b>	<b>0 986 430 257</b>

**M2000**

<b>12.163 L</b>	4,6	114	D 0824 LFL09 <V1700, Euro 2>	03.00-12.01	4	<b>0 432 131 820</b>	<b>0 986 430 257</b>
<b>12.224 M, ML</b>	6,9	162	D 0826 LF18 <V3000, Euro 2>	03.97-01.98	6	<b>0 432 131 820</b>	<b>0 986 430 257</b>
<b>12.255 MC, MLS</b>	6,9	180	D 0836 LF05 <V4000, Euro 3>	01.01-08.02	6 6	<b>0 432 133 766</b> <b>0 432 133 797<sup>1</sup></b>	
<b>12.264 M, ML</b>	6,9	191	D 0826 LF17 <V3000, Euro 2>	03.97-09.01	6 6	<b>0 432 133 840</b> <b>0 432 133 841<sup>1</sup></b>	
<b>12.284 MC, MLC, MLS</b>	6,9	206	D 0836 LF01 <V4000, Euro 2>	06.98-09.01	6 6	<b>0 432 133 766</b> <b>0 432 133 797<sup>1</sup></b>	
<b>12.285 MC</b>	6,9	206	D 0836 LF03 <V4000, Euro 3>	01.01-09.01	6 6	<b>0 432 133 766</b> <b>0 432 133 797<sup>1</sup></b>	
<b>14.224 M, MA, ML</b>	6,9	162	D 0826 LF15 <V3000, Euro 2> D 0826 LF18 <V3000, Euro 2>	08.95-03.97 03.97-01.98	6 6	<b>0 432 133 855</b> <b>0 432 131 820</b>	<b>0 986 430 313</b> <b>0 986 430 257</b>



									
14.264 M, MA, ML	6,9	191	D 0826 LF17 <V3000, Euro 2>		08.95-09.01		6	0 432 133 840	
							6	0 432 133 841 <sup>1</sup>	
14.284 LA-AF, LAC, LAK, LC, LRC, LK, LRK, LLC, LLLC	6,9	206	D 0836 LFL01 <V3900, Euro 2>		06.98-09.01		6	0 432 133 766	
MAK, MA-KO, MA-LF, MC, MLC, MLLC, MLS	6,9	206	D 0836 LF01 <V4000, Euro 2>		06.98-09.01		6	0 432 133 797 <sup>1</sup>	
15.284 LC, LK-LV, LLC, LLLC	6,9	206	D 0836 LFL01 <V3900, Euro 2>		06.98-09.01		6	0 432 133 766	
							6	0 432 133 797 <sup>1</sup>	
18.224 LS, AK, LA, MLLC	6,9	162	D 0826 LFL10 <V2300, Euro 2>		03.97→		6	0 432 131 820	0 986 430 257
M, MA, ML	6,9	162	D 0826 LF15 <V3000, Euro 2>		08.95-03.97		6	0 432 133 855	0 986 430 313
			D 0826 LF18 <V3000, Euro 2>		03.97-01.98		6	0 432 131 820	0 986 430 257
18.264 M, MA, ML	6,9	191	D 0826 LF17 <V3000, Euro 2>		08.95-09.01		6	0 432 133 840	
							6	0 432 133 841 <sup>1</sup>	
18.284 LAC, LAK-LV, LC, LK-LV, L-KO, LLC, LLK, LLLC	6,9	206	D 0836 LFL01 <V3900, Euro 2>		06.98-09.01		6	0 432 133 766	
LS, TSL, MAC, MAK, MAK-LV, MC, MK-LV, M-KO, MLK, MLLC, MLS	6,9	206	D 0836 LF01 <V4000, Euro 2>		06.98-09.01		6	0 432 133 766	
					06.98→		6	0 432 133 766	
							6	0 432 133 797 <sup>1</sup>	
20.284 LNLC, LNLLC	6,9	206	D 0836 LFL01 <V3900, Euro 2>		05.99-09.01		6	0 432 133 766	
							6	0 432 133 797 <sup>1</sup>	
25.224 M, ML, MVL	6,9	162	D 0826 LF15 <V3000, Euro 2>		08.95-03.97		6	0 432 133 855	0 986 430 313
			D 0826 LF18 <V3000, Euro 2>		03.97-01.98		6	0 432 131 820	0 986 430 257
25.264 M, ML, MVL	6,9	191	D 0826 LF17 <V3000, Euro 2>		08.95-09.01		6	0 432 133 840	
							6	0 432 133 841 <sup>1</sup>	
25.284 LNLS, MNLC, MNLLC, MVL	6,9	206	D 0836 LF01 <V4000, Euro 2>		06.98→		6	0 432 133 766	
							6	0 432 133 797 <sup>1</sup>	
26.225 DLK	6,9	119	D 0836 LFL02 <V3900, Euro 3>		01.99-02.02		6	0 432 133 799 <sup>1</sup>	
					01.99-06.02		6	0 432 133 765	
26.255 DLK	6,9	180	D 0836 LFL05 <V3900, Euro 3>		01.99-02.02		6	0 432 133 797 <sup>1</sup>	
					01.99-06.02		6	0 432 133 766	
26.284 DL, L, AK	6,9	206	D 0836 LFL01 <V3900, Euro 2>; D 0836 LF01 <V4000, Euro 2>		01.99→		6	0 432 133 766	
							6	0 432 133 797 <sup>1</sup>	
26.285 DLK, DL-TM	6,9	206	D 0836 LFL03 <V3900, Euro 3>		01.99-02.02		6	0 432 133 797 <sup>1</sup>	
					01.99-12.02		6	0 432 133 766	
<b>M2000 Evol. (LE)</b>									
12.180 F, FL	4,6	132	D 0834 LFL03 <V4400, Euro 3>		09.02-12.05		4	0 432 133 765	
							4	0 432 133 799 <sup>1</sup>	
12.220 F, FL	6,9	162	D 0836 LFL02 <V3900, Euro 3>		09.02-06.06		6	0 432 133 765	
12.250 F, FL	6,9	180	D 0836 LFL05 <V3900, Euro 3>		09.02-06.06		6	0 432 133 766	
12.280 F, FL	6,9	206	D 0836 LFL03 <V3900, Euro 3>		09.02-06.06		6	0 432 133 766	
14.220 F, FL	6,9	162	D 0836 LFL02 <V3900, Euro 3>		09.02-06.06		6	0 432 133 765	
14.225 F, FA	6,9	162	D 0836 LFL02 <V3900, Euro 3>		09.02-09.06		6	0 432 133 765	
14.250 F, FL	6,9	180	D 0836 LFL05 <V3900, Euro 3>		09.02-06.06		6	0 432 133 766	
14.255 F, FA	6,9	180	D 0836 LFL05 <V3900, Euro 3>		09.02-09.06		6	0 432 133 766	
14.280 F, FL	6,9	206	D 0836 LFL03 <V3900, Euro 3>		09.02-06.06		6	0 432 133 766	
14.285 F, FA	6,9	206	D 0836 LFL03 <V3900, Euro 3>		09.02-09.06		6	0 432 133 766	
15.180 F, FL	4,6	132	D 0834 LFL03 <V4400, Euro 3>		09.02-03.05		4	0 432 133 765	
							4	0 432 133 799 <sup>1</sup>	
15.220 F, FL	6,9	162	D 0836 LFL02 <V3900, Euro 3>		09.02-09.06		6	0 432 133 765	
15.250 F, FL	6,9	180	D 0836 LFL05 <V3900, Euro 3>		09.02-09.06		6	0 432 133 766	
15.280 F, FL	6,9	206	D 0836 LFL03 <V3900, Euro 3>		09.02-09.06		6	0 432 133 766	
18.220 F, FA, F, FL	6,9	162	D 0836 LFL02 <V3900, Euro 3>		09.02-09.06		6	0 432 133 765	
18.250B F, FA	6,9	180	D 0836 LF05 <V4000, Euro 3>		09.02-09.06		6	0 432 133 766	
							6	0 432 133 797 <sup>1</sup>	
F, FL	6,9	180	D 0836 LFL05 <V3900, Euro 3>		09.02-09.06		6	0 432 133 766	
18.280 F, FA, F, FL	6,9	206	D 0836 LFL03 <V3900, Euro 3>		09.02-09.06		6	0 432 133 766	
20.220 DF	6,9	162	D 0836 LFL02 <V3900, Euro 3>		09.02-09.06		6	0 432 133 765	
20.250 DF	6,9	180	D 0836 LFL05 <V3900, Euro 3>		09.02-09.06		6	0 432 133 766	
20.280 DF	6,9	206	D 0836 LFL03 <V3900, Euro 3>		09.02-09.06		6	0 432 133 766	
160B F, FA, F, FL	4,6	114	D 0824 LFL06 <V1700, Euro 2>		09.00-09.01		4	0 432 133 855	0 986 430 313
180B F, FL	4,6	132	D 0834 LFL03 <V4400, Euro 3>		07.01-08.02		4	0 432 133 765	
							4	0 432 133 799 <sup>1</sup>	















◀ MAN

<b>180C</b> F, FL	4,6	132	D 0834 LFL03 <V4400, Euro 3>	07.01-09.02	4	<b>0 432 133 765</b>
					4	<b>0 432 133 799<sup>1</sup></b>
<b>220B</b> DF, F, FA, F, FL	6,9	162	D 0836 LFL02 <V3900, Euro 3>	07.01-02.02	6	<b>0 432 133 799<sup>1</sup></b>
				07.01-09.02	6	<b>0 432 133 765</b>
DF, F, FL	6,9	162	D 0826 LFL10 <V2300, Euro 2>	08.00-09.01	6	<b>0 432 131 820 0 986 430 257</b>
<b>220C</b> F, FL	6,9	162	D 0836 LFL02 <V3900, Euro 3>	07.01-02.02	6	<b>0 432 133 799<sup>1</sup></b>
				07.01-08.02	6	<b>0 432 133 765</b>
<b>250B</b> DF, F, FA, F, FL	6,9	180	D 0836 LFL05 <V3900, Euro 3>	07.01-02.02	6	<b>0 432 133 797<sup>1</sup></b>
				07.01-08.02	6	<b>0 432 133 766</b>
				07.01-09.02	6	<b>0 432 133 766</b>
F, FA	6,9	180	D 0836 LF05 <V4000, Euro 3>	07.01-08.02	6	<b>0 432 133 766</b>
					6	<b>0 432 133 797<sup>1</sup></b>
<b>280B</b> DF, F, FA, F, FL	6,9	206	D 0836 LFL03 <V3900, Euro 3>	07.01-02.02	6	<b>0 432 133 797<sup>1</sup></b>
				07.01-09.02	6	<b>0 432 133 766</b>
DF, F, FL	6,9	206	D 0836 LF01 <V4000, Euro 2>	09.00-09.01	6	<b>0 432 133 766</b>
					6	<b>0 432 133 797<sup>1</sup></b>
<b>M2000 Evol. (ME)</b>						
<b>12.220</b> F, FL	6,9	162	D 0836 LF04 <V4000, Euro 3>	09.02-07.05	6	<b>0 432 133 765</b>
					6	<b>0 432 133 799<sup>1</sup></b>
<b>12.250</b> F, FL	6,9	180	D 0836 LF05 <V4000, Euro 3>	09.02-07.05	6	<b>0 432 133 766</b>
					6	<b>0 432 133 797<sup>1</sup></b>
<b>12.280</b> F, FL	6,9	206	D 0836 LF03 <V4000, Euro 3>	09.02-07.05	6	<b>0 432 133 766</b>
<b>14.220</b> F, FA, F, FL	6,9	162	D 0836 LF04 <V4000, Euro 3>	09.02-07.05	6	<b>0 432 133 765</b>
					6	<b>0 432 133 799<sup>1</sup></b>
<b>14.250</b> F, FA	6,9	180	D 0836 LF05 <V4000, Euro 3>	09.02-07.05	6	<b>0 432 133 766</b>
					6	<b>0 432 133 797<sup>1</sup></b>
F, FL	6,9	180	D 0836 LFL05 <V3900, Euro 3>	09.02-07.05	6	<b>0 432 133 766</b>
<b>14.280</b> F, FA, F, FL	6,9	206	D 0836 LFL03 <V3900, Euro 3>	09.02-07.05	6	<b>0 432 133 766</b>
<b>18.220</b> F, FA, F, FL	6,9	162	D 0836 LF04 <V4000, Euro 3>	09.02-07.05	6	<b>0 432 133 765</b>
					6	<b>0 432 133 799<sup>1</sup></b>
<b>18.250</b> F, FA, F, FL	6,9	180	D 0836 LFL05 <V3900, Euro 3>	09.02-07.05	6	<b>0 432 133 766</b>
<b>18.280</b> F, FA, F, FL	6,9	206	D 0836 LFL03 <V3900, Euro 3>	09.02-07.05	6	<b>0 432 133 766</b>
<b>25.250</b> DF	6,9	180	D 0836 LF05 <V4000, Euro 3>	09.02-07.05	6	<b>0 432 133 766</b>
					6	<b>0 432 133 797<sup>1</sup></b>
<b>25.280</b> DF	6,9	206	D 0836 LF03 <V4000, Euro 3>	09.02-07.05	6	<b>0 432 133 766</b>
<b>220B</b> F, FA, F, FL	6,9	162	D 0836 LF04 <V4000, Euro 3>	09.00-08.02	6	<b>0 432 133 765</b>
					6	<b>0 432 133 799<sup>1</sup></b>
<b>250B</b> DF, F, FA	6,9	180	D 0836 LF05 <V4000, Euro 3>	07.01-08.02	6	<b>0 432 133 766</b>
					6	<b>0 432 133 797<sup>1</sup></b>
F, FA, F, FL	6,9	180	D 0836 LFL05 <V3900, Euro 3>	06.01-02.02	6	<b>0 432 133 797<sup>1</sup></b>
				06.01-08.02	6	<b>0 432 133 766</b>
				06.01-09.02	6	<b>0 432 133 766</b>
<b>280B</b> DF	6,9	206	D 0836 LF03 <V4000, Euro 3>	07.01-02.02	6	<b>0 432 133 797<sup>1</sup></b>
				07.01-09.02	6	<b>0 432 133 766</b>
DF, F, FA, F, FL	6,9	206	D 0836 LF01 <V4000, Euro 2>	08.00-09.01	6	<b>0 432 133 766</b>
					6	<b>0 432 133 797<sup>1</sup></b>
F, FA, F, FL	6,9	206	D 0836 LFL03 <V3900, Euro 3>	07.01-02.02	6	<b>0 432 133 797<sup>1</sup></b>
				07.01-08.02	6	<b>0 432 133 766</b>
<b>NG</b>						
<b>262</b>	6,9	191	D 0826 LUH13 <V0300, Euro 2>	06.97-07.98	6	<b>0 432 133 840</b>
					6	<b>0 432 133 841<sup>1</sup></b>
	10,0	191	D 2865 LUH09 <V1400, Euro 2>	06.97-07.98	5	<b>0 432 131 633</b>
	12,0	191	D 2866 LUH22 <V3200, Euro 2>	07.98-11.99	6	<b>0 432 131 631<sup>1</sup></b>
					6	<b>0 432 131 633</b>
<b>263</b> F	12,0	191	D 2866 LUH22 <V3200, Euro 2>	07.98-12.01	6	<b>0 432 131 631<sup>1</sup></b>
					6	<b>0 432 131 633</b>
			D 2866 LUH23 <V5000, Euro 3>	01.01-09.06	6	<b>0 432 191 417<sup>1</sup></b>
					6	<b>0 432 191 419</b>
<b>272</b>	6,9	198	D 0826 LUH01 <V0300, Euro 1>	08.92-09.95	6	<b>0 432 131 820 0 986 430 257</b>
<b>312</b>	10,0	228	D 2865 LUH07 <V1400, Euro 2>	09.95-07.98	5	<b>0 432 131 733<sup>1</sup></b>
					5	<b>0 432 131 760 0 986 430 451</b>
	12,0	228	D 2866 LUH26 <V3200, Euro 2>	07.98-11.99	6	<b>0 432 131 631<sup>1</sup></b>
					6	<b>0 432 131 633</b>



										
<b>313 F</b>	12,0	228	D 2866 LUH24 <V5000, Euro 3>		01.01-09.06		6	<b>0 432 191 417</b> <sup>1</sup>		
							6	<b>0 432 191 419</b>		
			D 2866 LUH26 <V3200, Euro 2>		07.98-12.01		6	<b>0 432 131 631</b> <sup>1</sup>		
							6	<b>0 432 131 633</b>		
<b>363 F</b>	12,0	265	D 2866 LUH25 <V5000, Euro 3>		01.01-09.06		6	<b>0 432 191 417</b> <sup>1</sup>		
							6	<b>0 432 191 419</b>		
<b>R</b>										
<b>292</b>	12,0	213-224	D 2866 TUH/290 <V0100>		03.86-04.92		6	<b>0 430 233 028</b>		
		229	D 2866 TOH/310 <Z7900>		04.92-01.93		6	<b>0 432 231 778</b>	<b>0 986 430 159</b>	
<b>RH</b>										
<b>352</b>	12,0	257	D 2866 LOH26 <V1500, Euro 2>		07.98-09.01		6	<b>0 432 131 631</b> <sup>1</sup>		
							6	<b>0 432 131 633</b>		
<b>402</b>	12,0	294	D 2866 LOH23 <V1500, Euro 2>		07.98-09.01		6	<b>0 432 131 734</b> <sup>1</sup>		
							6	<b>0 432 131 788</b>	<b>0 986 430 312</b>	
<b>403 F</b>	12,0	294	D 2866 LOH23 <V1500, Euro 2>		06.99-09.01		6	<b>0 432 131 734</b> <sup>1</sup>		
							6	<b>0 432 131 788</b>	<b>0 986 430 312</b>	
<b>RN</b>										
<b>313</b>	12,0	228	D 2866 LUH20 <V3200, Euro 2>		09.96-03.98		6	<b>0 432 131 633</b>		
<b>353</b>	12,0	257	D 2866 LUH21 <V3200, Euro 2>		06.97-03.98		6	<b>0 432 131 631</b> <sup>1</sup>		
							6	<b>0 432 131 633</b>		
<b>RÜ</b>										
<b>240</b>	12,0	177	D 2866 UH/240 <Z6500, Euro 1>		01.80-12.88		6	<b>0 432 231 768</b>		
<b>280</b>	11,4	206	D 2566 MTUH/280		07.80-12.88	CSA	6	<b>0 432 231 839</b>		
<b>SD</b>										
<b>200</b>	11,4	147	D 2566 MUH/200							
			Mot.Nr. 4153→		11.81-11.86		6	<b>0 432 231 794</b>		
<b>202 , F</b>	11,4	155	D 2566 UH <Z5500,>							
			Mot.Nr. →5081 000		10.85-04.94		6	<b>0 430 233 028</b>		
<b>F</b>	11,4	150-157	D 2566 UH/205 <Z5500,>		01.87-04.91		6	<b>0 432 231 768</b>		
			Mot.Nr. →5081 000		01.87-04.91		6	<b>0 430 233 028</b>		
<b>SG</b>										
<b>240 H</b>	12,0	177	D 2866 UH/240 <Z6500, Euro 1>		01.86-12.86		6	<b>0 432 231 768</b>		
		213	D 2866 TUH/290 <V0100>		01.86-12.86		6	<b>0 430 233 028</b>		
<b>H, HÜ</b>	11,4	206	D 2566 MTUH/280		09.81-01.86	CSA	6	<b>0 432 231 839</b>		
<b>HÜ</b>	11,4	177	D 2566 MUH/240		01.84-01.86		6	<b>0 432 231 776</b>		
<b>242</b>	12,0	213-224	D 2866 TUH/290 <V0100>		09.85-02.94		6	<b>0 430 233 028</b>		
<b>, F, H</b>	12,0	177-180	D 2866 UH/240 <Z6500, Euro 1>		09.85-09.89		6	<b>0 432 231 768</b>		
					09.85-04.94		6	<b>0 432 231 768</b>		
<b>263 F</b>	12,0	191	D 2866 LUH23 <V5000, Euro 3>		06.04-09.06		6	<b>0 432 191 417</b> <sup>1</sup>		
							6	<b>0 432 191 419</b>		
<b>292</b>	12,0	229	D 2866 TOH/310 <Z7900>		04.92-04.93		6	<b>0 432 231 778</b>	<b>0 986 430 159</b>	
<b>H</b>	12,0	213	D 2866 TUH/290 <V0100>		11.84-09.89		6	<b>0 430 233 028</b>		
<b>312</b>	10,0	228	D 2865 LUH07 <V1400, Euro 2>		02.96-06.97		5	<b>0 432 131 733</b> <sup>1</sup>		
							5	<b>0 432 131 760</b>	<b>0 986 430 451</b>	
<b>313 F</b>	12,0	228	D 2866 LUH24 <V5000, Euro 3>		06.04-09.06		6	<b>0 432 191 417</b> <sup>1</sup>		
							6	<b>0 432 191 419</b>		
<b>SL</b>										
<b>200 , F</b>	11,4	147-150	D 2566 UH/205 <Z5500,>		06.83-04.87		6	<b>0 432 231 777</b>		
			Mot.Nr. →5081 000		06.83-04.87		6	<b>0 430 233 028</b>		
		177	D 2566 MUH/240		01.84-01.86		6	<b>0 432 231 776</b>		
	12,0	177	D 2866 UH/240 <Z6500, Euro 1>		01.86-04.87		6	<b>0 432 231 768</b>		
<b>223 F</b>	6,9	162	D 0836 LOH03 <V4900, Euro 3>		06.04-09.06		6	<b>0 432 133 765</b>		
<b>283 F</b>	6,9	206	D 0836 LOH02 <V4900, Euro 3>		06.04-09.06		6	<b>0 432 133 766</b>		
<b>SL II</b>										
<b>202</b>	12,0	177-180	D 2866 UH/240 <Z6500, Euro 1>		06.84-04.94		6	<b>0 432 231 768</b>		
<b>, F</b>	11,4	147-157	D 2566 UH <Z5500,>							
			Mot.Nr. →5081 000		06.84-04.93		6	<b>0 430 233 028</b>		
<b>SM</b>										
<b>152 MIDI</b>	6,9	110-114	D 0826 OH02 <Z9300>		11.87-04.94		6	<b>0 432 133 872</b>		
<b>182 MIDI</b>	6,9	130-137	D 0826 TOH01 <Z8600>		11.87-04.92		6	<b>0 432 131 820</b>	<b>0 986 430 257</b>	
<b>192 MIDI</b>	6,9	140	D 0826 LOH01 <V0900, Euro 1>		04.92-02.95		6	<b>0 432 131 820</b>	<b>0 986 430 257</b>	
<b>SR</b>										
<b>280 H</b>	11,4	206	D 2566 MTUH/280		07.80-11.86	CSA	6	<b>0 432 231 839</b>		















◀ MAN

<b>321 H</b>	11,4	235	D 2566 MKUH/320	03.82-11.86	CSA	6	<b>0 432 231 839</b>
<b>361 H</b>	12,0	265	D 2866 KUH/360 <Z6400, Euro 1>	06.84-11.86		6	<b>0 432 231 778 0 986 430 159</b>
<b>SÜ</b>							
<b>223</b>	6,9	162	D 0826 LOH19 <V2900, Euro 2>	11.99-09.01		6	<b>0 432 131 820 0 986 430 257</b>
F	6,9	162	D 0836 LOH03 <V4900, Euro 3>	06.04-09.06		6	<b>0 432 133 765</b>
<b>240</b>	11,4	147-150	D 2566 UH/205 <Z5500,> Mot.Nr. ->5081 000	01.86-09.89		6	<b>0 430 233 028</b>
,F	11,4	177	D 2566 MUH/240	11.83-01.86		6	<b>0 432 231 776</b>
		206	D 2566 MTUH/280	07.80-01.86	CSA	6	<b>0 432 231 839</b>
	12,0	177	D 2866 UH/240 <Z6500, Euro 1>	01.86-02.88		6	<b>0 432 231 768</b>
				01.86-09.89		6	<b>0 432 231 768</b>
		213	D 2866 TUH/290 <V0100>	01.86-02.88		6	<b>0 430 233 028</b>
				01.86-09.89		6	<b>0 430 233 028</b>
<b>242</b>	12,0	177-180	D 2866 UH/240 <Z6500, Euro 1>	01.87-04.93		6	<b>0 432 231 768</b>
<b>263</b>	6,9	191	D 0826 LOH18 <V2900, Euro 2>	11.99-09.01		6	<b>0 432 133 840</b>
						6	<b>0 432 133 841<sup>1</sup></b>
<b>272</b>	10,0	198	D 2865 LUH02 <V1400, Euro 1>	04.93-05.95		5	<b>0 432 131 831 0 986 430 228</b>
<b>283 F</b>	6,9	206	D 0836 LOH02 <V4900, Euro 3>	06.04-09.06		6	<b>0 432 133 766</b>
<b>292</b>	12,0	229	D 2866 TOH/310 <Z7900>	04.92-04.93		6	<b>0 432 231 778 0 986 430 159</b>
<b>313</b>	12,0	228	D 2866 LUH26 <V3200, Euro 2>	11.99-06.01		6	<b>0 432 131 631<sup>1</sup></b>
						6	<b>0 432 131 633</b>
F	12,0	228	D 2866 LUH24 <V5000, Euro 3>	06.04-09.06		6	<b>0 432 191 417<sup>1</sup></b>
						6	<b>0 432 191 419</b>
<b>363 F</b>	12,0	265	D 2866 LUH25 <V5000, Euro 3>	06.04-09.06		6	<b>0 432 191 417<sup>1</sup></b>
						6	<b>0 432 191 419</b>
<b>383 F</b>	12,0	265	D 2866 LUH25 <V5000, Euro 3>	06.04-09.06		6	<b>0 432 191 417<sup>1</sup></b>
						6	<b>0 432 191 419</b>
<b>TG</b>							
<b>310A DF, F, FL</b>	12,0	228	D 2866 LF26 <V4200, Euro 3>	03.99-08.02		6	<b>0 432 191 417<sup>1</sup></b>
						6	<b>0 432 191 419</b>
			D 2866 LF36 <V4200, Euro 2>	03.99-09.01		6	<b>0 432 191 414<sup>1</sup></b>
				03.00-09.01		6	<b>0 432 191 416</b>
<b>360A D, DF, F, FL</b>	12,0	265	D 2866 LF27 <V4200, Euro 3>	03.99-08.02		6	<b>0 432 191 417<sup>1</sup></b>
						6	<b>0 432 191 419</b>
D, F, FL	12,0	265	D 2866 LF37 <V4200, Euro 2>	03.99-09.01		6	<b>0 432 191 414<sup>1</sup></b>
						6	<b>0 432 191 416</b>
<b>410A D, DF, F, FL</b>	12,0	301	D 2866 LF28 <V4200, Euro 3>	03.99-08.02		6	<b>0 432 191 417<sup>1</sup></b>
						6	<b>0 432 191 419</b>
DF, F, FL	12,0	301	D 2866 LF32 <V4200, Euro 2>	03.99-08.02		6	<b>0 432 191 416</b>
				04.00-08.02		6	<b>0 432 191 414<sup>1</sup></b>
<b>460A D, DF, F, FL, F-, FL-WW</b>	12,8	338	D 2876 LF04 <V4300, Euro 3>; D 2876 LF07 <V4300, Euro 2>	03.99-04.07		6	<b>0 432 191 414<sup>1</sup></b>
						6	<b>0 432 191 416</b>
<b>510A DF, F, FL</b>	12,8	375	D 2876 LF05 <V4300, Euro 3>	03.99-08.02		6	<b>0 432 191 414<sup>1</sup></b>
						6	<b>0 432 191 416</b>
<b>TGA</b>							
<b>18.310 F, FA, FC, FK, FL</b>	12,0	228	D 2866 LF26 <V4200, Euro 3>	09.02-12.05		6	<b>0 432 191 417<sup>1</sup></b>
						6	<b>0 432 191 419</b>
<b>18.360 F, FA, FC, FK, FL</b>	12,0	265	D 2866 LF27 <V4200, Euro 3>	09.02-12.05		6	<b>0 432 191 417<sup>1</sup></b>
						6	<b>0 432 191 419</b>
<b>18.410 F, FA, FC, FK, FL</b>	12,0	301	D 2866 LF28 <V4200, Euro 3>	09.02-12.05		6	<b>0 432 191 417<sup>1</sup></b>
						6	<b>0 432 191 419</b>
<b>18.460 F, FL</b>	12,8	338	D 2876 LF04 <V4300, Euro 3>	09.02-05.04		6	<b>0 432 191 414<sup>1</sup></b>
						6	<b>0 432 191 416</b>
<b>18.510 FC, FK, FL</b>	12,8	375	D 2876 LF05 <V4300, Euro 3>	09.02-06.03		6	<b>0 432 191 414<sup>1</sup></b>
						6	<b>0 432 191 416</b>
<b>24.360 DF</b>	12,0	265	D 2866 LF27 <V4200, Euro 3>	11.02-05.04		6	<b>0 432 191 417<sup>1</sup></b>
						6	<b>0 432 191 419</b>
<b>24.410 DF</b>	12,0	301	D 2866 LF28 <V4200, Euro 3>	11.02-05.04		6	<b>0 432 191 417<sup>1</sup></b>
						6	<b>0 432 191 419</b>
<b>24.460 DF</b>	12,8	338	D 2876 LF04 <V4300, Euro 3>	11.02-05.04		6	<b>0 432 191 414<sup>1</sup></b>
						6	<b>0 432 191 416</b>
<b>24.510 DF</b>	12,8	375	D 2876 LF05 <V4300, Euro 3>	11.02-06.03		6	<b>0 432 191 414<sup>1</sup></b>
						6	<b>0 432 191 416</b>





									
<b>26.310</b> DA, FD, FN, FP, FV	12,0	228	D 2866 LF26 <V4200, Euro 3>		09.02-12.05		6	<b>0 432 191 417</b> <sup>1</sup>	
							6	<b>0 432 191 419</b>	
<b>26.360</b> DA, FD, FN, FP, FV	12,0	265	D 2866 LF27 <V4200, Euro 3>		09.02-12.05		6	<b>0 432 191 417</b> <sup>1</sup>	
							6	<b>0 432 191 419</b>	
<b>26.410</b> DA, FD, FN, FP, FV	12,0	301	D 2866 LF28 <V4200, Euro 3>		09.02-12.05		6	<b>0 432 191 417</b> <sup>1</sup>	
							6	<b>0 432 191 419</b>	
<b>26.460</b> FD, FN, FP, FV	12,8	338	D 2876 LF04 <V4300, Euro 3>		09.02-06.05		6	<b>0 432 191 414</b> <sup>1</sup>	
							6	<b>0 432 191 416</b>	
<b>26.510</b> FD, FN, FP, FV	12,8	375	D 2876 LF05 <V4300, Euro 3>		09.02-06.03		6	<b>0 432 191 414</b> <sup>1</sup>	
							6	<b>0 432 191 416</b>	
<b>28.310</b> DF	12,0	228	D 2866 LF26 <V4200, Euro 3>		09.02-06.05		6	<b>0 432 191 417</b> <sup>1</sup>	
							6	<b>0 432 191 419</b>	
<b>28.360</b> DF, L, FL	12,0	265	D 2866 LF27 <V4200, Euro 3>		09.02-06.05		6	<b>0 432 191 417</b> <sup>1</sup>	
							6	<b>0 432 191 419</b>	
<b>28.410</b> DF	12,0	301	D 2866 LF28 <V4200, Euro 3>		09.02-06.05		6	<b>0 432 191 417</b> <sup>1</sup>	
							6	<b>0 432 191 419</b>	
<b>28.460</b> DF	12,8	338	D 2876 LF04 <V4300, Euro 3>		09.02-05.04		6	<b>0 432 191 414</b> <sup>1</sup>	
							6	<b>0 432 191 416</b>	
<b>28.510</b> DF	12,8	375	D 2876 LF05 <V4300, Euro 3>		09.02-06.03		6	<b>0 432 191 414</b> <sup>1</sup>	
							6	<b>0 432 191 416</b>	
<b>32.310</b> FFD	12,0	228	D 2866 LF26 <V4200, Euro 3>		06.02-05.04		6	<b>0 432 191 417</b> <sup>1</sup>	
							6	<b>0 432 191 419</b>	
<b>32.360</b> DA, FFD, VF	12,0	265	D 2866 LF27 <V4200, Euro 3>		09.02-01.06		6	<b>0 432 191 417</b> <sup>1</sup>	
							6	<b>0 432 191 419</b>	
<b>32.410</b> DA, FFD, VF	12,0	301	D 2866 LF28 <V4200, Euro 3>		09.02-01.06		6	<b>0 432 191 417</b> <sup>1</sup>	
							6	<b>0 432 191 419</b>	
<b>32.460</b> FFD, VF	12,8	338	D 2876 LF04 <V4300, Euro 3>		09.02-01.06		6	<b>0 432 191 414</b> <sup>1</sup>	
							6	<b>0 432 191 416</b>	
<b>33.360</b> FD	12,0	265	D 2866 LF27 <V4200, Euro 3>		09.02-02.08		6	<b>0 432 191 417</b> <sup>1</sup>	
							6	<b>0 432 191 419</b>	
<b>33.410</b> DA, DF	12,0	301	D 2866 LF28 <V4200, Euro 3>		09.02-12.05		6	<b>0 432 191 417</b> <sup>1</sup>	
							6	<b>0 432 191 419</b>	
<b>33.460</b> DF, FD-WW	12,8	338	D 2876 LF04 <V4300, Euro 3>; D 2876 LF07 <Euro 2>		09.02-06.07		6	<b>0 432 191 414</b> <sup>1</sup>	
							6	<b>0 432 191 416</b>	
<b>33.510</b> DF	12,8	375	D 2876 LF05 <V4300, Euro 3>		09.02-06.03		6	<b>0 432 191 414</b> <sup>1</sup>	
							6	<b>0 432 191 416</b>	
<b>35.310</b> FFD	12,0	228	D 2866 LF26 <V4200, Euro 3>		06.03-06.05		6	<b>0 432 191 417</b> <sup>1</sup>	
							6	<b>0 432 191 419</b>	
<b>35.360</b> FFD, FFDK	12,0	265	D 2866 LF27 <V4200, Euro 3>		06.03-09.06		6	<b>0 432 191 417</b> <sup>1</sup>	
							6	<b>0 432 191 419</b>	
<b>35.410</b> FFD	12,0	301	D 2866 LF28 <V4200, Euro 3>		06.03-12.05		6	<b>0 432 191 417</b> <sup>1</sup>	
							6	<b>0 432 191 419</b>	
<b>35.460</b> FFD, VF	12,8	338	D 2876 LF04 <V4300, Euro 3>		06.03-06.05		6	<b>0 432 191 414</b> <sup>1</sup>	
							6	<b>0 432 191 416</b>	
<b>37.360</b> VF	12,0	265	D 2866 LF27 <V4200, Euro 3>		05.04-12.05		6	<b>0 432 191 417</b> <sup>1</sup>	
							6	<b>0 432 191 419</b>	
<b>37.410</b> VF	12,0	301	D 2866 LF28 <V4200, Euro 3>		05.04-12.05		6	<b>0 432 191 417</b> <sup>1</sup>	
							6	<b>0 432 191 419</b>	
<b>37.460</b> VF	12,8	338	D 2876 LF04 <V4300, Euro 3>		05.04-06.05		6	<b>0 432 191 414</b> <sup>1</sup>	
							6	<b>0 432 191 416</b>	
<b>40.410</b> , FD	12,0	301	D 2866 LF28 <V4200, Euro 3>		06.04-12.05		6	<b>0 432 191 417</b> <sup>1</sup>	
							6	<b>0 432 191 419</b>	
<b>41.360</b> FFD	12,0	265	D 2866 LF27 <V4200, Euro 3>		09.02-12.05		6	<b>0 432 191 417</b> <sup>1</sup>	
							6	<b>0 432 191 419</b>	
<b>41.410</b> FFD	12,0	301	D 2866 LF28 <V4200, Euro 3>		09.02-12.05		6	<b>0 432 191 417</b> <sup>1</sup>	
							6	<b>0 432 191 419</b>	
<b>41.460</b> F-, FL-WW, FV	12,8	338	D 2876 LF04 <V4300, Euro 3>; D 2876 LF07 <Euro 2>		09.02-05.10		6	<b>0 432 191 414</b> <sup>1</sup>	
							6	<b>0 432 191 416</b>	
<b>ÜL</b>									
<b>242</b>	12,0	177	D 2866 UH/240 <Z6500, Euro 1>		09.89-03.93		6	<b>0 432 231 768</b>	
<b>272</b>	10,0	198	D 2865 LUH02 <V1400, Euro 1>		03.93-07.94		5	<b>0 432 131 831</b>	<b>0 986 430 228</b>
			D 2865 LUH05 <Euro 1>		07.94-09.95		5	<b>0 432 131 784</b>	















◀ MAN

<b>292</b>	12,0	213	D 2866 TUH01 <V0100>	09.89-03.93	6	<b>0 430 233 028</b>	
					6	<b>0 432 231 778</b>	<b>0 986 430 159</b>
<b>312</b>	10,0	228	D 2865 LUH07 <V1400, Euro 2>	09.95-09.96	5	<b>0 432 131 733</b> <sup>1</sup>	
					5	<b>0 432 131 760</b>	<b>0 986 430 451</b>
<b>313</b>	12,0	228	D 2866 LUH20 <V3200, Euro 2>	09.96-09.01	6	<b>0 432 131 633</b>	
			D 2866 LUH24 <V5000, Euro 3>	05.99-09.06	6	<b>0 432 191 417</b> <sup>1</sup>	
				03.00-09.06	6	<b>0 432 191 419</b>	
<b>353</b>	12,0	257	D 2866 LUH21 <V3200, Euro 2>	06.97-12.01	6	<b>0 432 131 631</b> <sup>1</sup>	
					6	<b>0 432 131 633</b>	
<b>363</b>	12,0	265	D 2866 LUH25 <V5000, Euro 3>	01.01-09.06	6	<b>0 432 191 417</b> <sup>1</sup>	
					6	<b>0 432 191 419</b>	
<b>6t</b>							
<b>6.100 F</b>	4,6	75	D 0824 GF, GF01 <Z8200>				
			Mot.Nr. GF→	09.87-12.92	4	<b>0 432 131 863</b>	
			Mot.Nr. GF01→	09.87-12.92	4	<b>0 432 231 718</b>	
			D 0824 GF02 <Z8200, Euro 1>	10.92-10.93	4	<b>0 432 133 872</b>	
<b>6.90 F</b>	3,8	66	D 0224 MF	10.79-09.87	4	<b>0 432 231 820</b>	
<b>8t</b>							
<b>8.100 F</b>	4,6	75	D 0824 GF, GF01 <Z8200>				
			Mot.Nr. GF→	09.87-12.92	4	<b>0 432 131 863</b>	
			Mot.Nr. GF01→	09.87-12.92	4	<b>0 432 231 718</b>	
			D 0824 GF02 <Z8200, Euro 1>	10.92-10.93	4	<b>0 432 133 872</b>	
<b>8.136 F, FL</b>	5,7	100	D 0226 MF	10.79-09.87	6	<b>0 432 231 820</b>	
<b>8.150 F, FAE, FL</b>	6,9	110-114	D 0826 GF <Z8300>	09.87-12.92	6	<b>0 432 131 863</b>	
F, FAKO, FL	6,9	110	D 0826 GF03 <Z8300, Euro 1>	10.92-05.95	6	<b>0 432 133 872</b>	
F, FL	5,7	92	D 0226 MF/Silent	05.90-10.93	6	<b>0 432 231 820</b>	
<b>8.90 F</b>	3,8	66	D 0224 MF	10.79-09.87	4	<b>0 432 231 820</b>	
<b>9t</b>							
<b>9.136 F, FL</b>	5,7	100	D 0226 MF	10.79-09.87	6	<b>0 432 231 820</b>	
<b>9.150 F, FAE, FL</b>	6,9	110-114	D 0826 GF <Z8300>	09.87-12.92	6	<b>0 432 131 863</b>	
F, FAKO, FL	6,9	110	D 0826 GF03 <Z8300, Euro 1>	10.92-05.95	6	<b>0 432 133 872</b>	
F, FL	5,7	92	D 0226 MF/Silent	05.90-10.93	6	<b>0 432 231 820</b>	
<b>10t</b>							
<b>10.136 F, FL</b>	5,7	100	D 0226 MF	09.81-09.87	6	<b>0 432 231 820</b>	
<b>10.150 F, FL</b>	5,7	92	D 0226 MF/Silent	05.90-10.93	6	<b>0 432 231 820</b>	
	6,9	110	D 0826 GF03 <Z8300, Euro 1>	10.92-10.93	6	<b>0 432 133 872</b>	
		110-114	D 0826 GF01 <Z8300>	09.87-03.90	6	<b>0 432 131 863</b>	
				04.90-12.92	6	<b>0 432 231 718</b>	
<b>12t</b>							
<b>12.136 F, FL, FR</b>	5,7	100	D 0226 MF	09.83-01.88	6	<b>0 432 231 820</b>	
<b>12.152 F, FL</b>	4,6	114	D 0824 LF01 <V2700, Euro 1>	05.94-06.97	4	<b>0 432 131 820</b>	<b>0 986 430 257</b>
	6,9	110	D 0826 F02 <V0200, Euro 1>	10.92-05.94	6	<b>0 432 133 872</b>	
		110-114	D 0826 F01 <V0200>	12.88-10.92	6	<b>0 432 231 718</b>	
<b>12.162 F, FL</b>	4,6	118	D 0824 LF02 <V2700, Euro 2>	08.95-06.97	4	<b>0 432 133 855</b>	<b>0 986 430 313</b>
<b>12.170 F, FL, FR</b>	5,7	125	D 0226 MKF/170	04.83-02.89	6	<b>0 432 231 788</b>	
<b>12.192 F, FA, FL</b>	6,9	140	D 0826 LF05 <Z9500, Euro 1>; D 0826 LF07 <Z9500, Euro 1>	07.93-06.96	6	<b>0 432 131 820</b>	<b>0 986 430 257</b>
F, FL	6,6	137	D 0826 TF <Z9400>	08.88-06.90	6	<b>0 432 131 861</b>	
F, FL, FR	6,9	140	D 0826 LF01 <Z9500>	07.90-10.92	6	<b>0 432 131 858</b>	
F, FL, FR	5,7	141	D 0226 MKF	09.83-02.89	6	<b>0 432 231 788</b>	
<b>12.222 F, FA, FL</b>	6,9	162	D 0826 LF11 <Z9500, Euro 2>	05.94-06.96	6	<b>0 432 133 855</b>	<b>0 986 430 313</b>
<b>12.232 F, FA, FL</b>	6,9	169	D 0826 LF02 <Z9500>	08.88-10.92	6	<b>0 432 131 858</b>	
			D 0826 LF06 <Z9500, Euro 1>; D 0826 LF08 <Z9500, Euro 1>	07.93-06.96	6	<b>0 432 131 820</b>	<b>0 986 430 257</b>
<b>12.262 F, FL</b>	6,9	191	D 0826 LF13 <Z9500, Euro 2>	08.95-06.96	6	<b>0 432 133 840</b>	
					6	<b>0 432 133 841</b> <sup>1</sup>	
<b>12.272 F, FA, FL</b>	6,9	198	D 0826 LF04 <Z9500, Euro 1>	10.92-06.96	6	<b>0 432 131 820</b>	<b>0 986 430 257</b>
FL	10,0	198	D 2865 LF02 <V0700>	09.91-10.92	5	<b>0 432 131 831</b>	<b>0 986 430 228</b>
<b>14t</b>							
<b>14.136 F, FL, FR</b>	5,7	100	D 0226 MF	09.83-02.89	6	<b>0 432 231 820</b>	
<b>14.152 F, FL</b>	4,6	114	D 0824 LF01 <V2700, Euro 1>	05.94-06.97	4	<b>0 432 131 820</b>	<b>0 986 430 257</b>
	6,9	110	D 0826 F02 <V0200, Euro 1>	12.91-05.94	6	<b>0 432 133 872</b>	
		110-114	D 0826 F01 <V0200>	12.88-12.91	6	<b>0 432 231 718</b>	



										
<b>14.162</b> F, FL	4,6	118	D 0824 LF02 <V2700, Euro 2>	08.95-06.97	4	<b>0 432 133 855</b>	<b>0 986 430 313</b>			
<b>14.170</b> F, FA, FL, FR	5,7	125	D 0226 MKF/170	04.83-07.89	6	<b>0 432 231 788</b>				
<b>14.192</b> F, FA, FL, FR	5,7	141	D 0226 MKF	09.83-07.89	6	<b>0 432 231 788</b>				
F, FL	6,6	137	D 0826 TF <Z9400>	08.88-06.90	6	<b>0 432 131 861</b>				
	6,9	140	D 0826 LF01 <Z9500>	07.90-10.92	6	<b>0 432 131 858</b>				
			D 0826 LF05 <Z9500, Euro 1>; D 0826 LF07 <Z9500, Euro 1>	07.93-06.96	6	<b>0 432 131 820</b>	<b>0 986 430 257</b>			
U, UL	9,5	141	D 2565 MUL	06.75-07.89	5	<b>0 432 231 850</b>				
<b>14.220</b> F, FL	11,4	162	D 2566 MF/220	10.83-02.89	6	<b>0 432 231 776</b>				
<b>14.222</b> F, FL	6,9	162	D 0826 LF11 <Z9500, Euro 2>	05.94-06.96	6	<b>0 432 133 855</b>	<b>0 986 430 313</b>			
<b>14.232</b> F, FL	6,9	160	D 0826 LF/217/Silent <Z9500>	05.90-04.92	6	<b>0 432 131 858</b>				
				07.93-04.95	6	<b>0 432 131 820</b>	<b>0 986 430 257</b>			
		169	D 0826 LF02 <Z9500>	08.88-10.92	6	<b>0 432 131 858</b>				
			D 0826 LF06 <Z9500, Euro 1>	07.93-05.94	6	<b>0 432 131 820</b>	<b>0 986 430 257</b>			
			D 0826 LF08 <Z9500, Euro 1>	05.94-06.96	6	<b>0 432 131 820</b>	<b>0 986 430 257</b>			
<b>14.262</b> F, FL	6,9	191	D 0826 LF13 <Z9500, Euro 2>	08.95-06.96	6	<b>0 432 133 840</b>				
					6	<b>0 432 133 841</b> <sup>1</sup>				
<b>14.272</b> F, FL	6,9	198	D 0826 LF04 <Z9500, Euro 1>	07.93-06.96	6	<b>0 432 131 820</b>	<b>0 986 430 257</b>			
	10,0	198	D 2865 LF02 <V0700>	09.91-10.92	5	<b>0 432 131 831</b>	<b>0 986 430 228</b>			
U	10,0	198	D 2865 LU01/Silent <V0500>	05.90-10.93	5	<b>0 432 131 866</b>	<b>0 986 430 228</b>			
<b>15t</b>										
<b>15.220</b> F, FL	11,4	162	D 2566 MF/220	10.83-02.89	6	<b>0 432 231 776</b>				
<b>15.240</b> F, FL, H, HA	11,4	177	D 2566 M; D 2566 MF	11.76-08.88	6	<b>0 432 231 850</b>				
<b>16t</b>										
<b>16.136</b> F, FL	5,7	100	D 0226 MF	04.84-11.86	6	<b>0 432 231 820</b>				
<b>16.168</b> F, FL	9,5	124	D 2565 MF	12.76-12.86	5	<b>0 432 231 850</b>				
<b>16.170</b> F, FA, FL	5,7	125	D 0226 MKF/170	03.84-11.86	6	<b>0 432 231 788</b>				
<b>16.192</b> F, FA, FL	5,7	141	D 0226 MKF	03.84-11.86	6	<b>0 432 231 788</b>				
	9,5	141	D 2565 MF	04.77-12.86	5	<b>0 432 231 850</b>				
<b>16.220</b> F, FA, FL	11,4	162	D 2566 MF/220	10.83-11.86	6	<b>0 432 231 776</b>				
<b>16.240</b> F, FA, FL, FR, H, HA	11,4	177	D 2566 M; D 2566 MF	11.76-06.89	6	<b>0 432 231 850</b>				
<b>16.280</b> FT	11,4	206	D 2566 MTF	07.80-12.86	6	<b>0 432 231 839</b>				
<b>17t</b>										
<b>17.136</b> F, FL, FR, FRL	5,7	100	D 0226 MF	11.86-08.88	6	<b>0 432 231 820</b>				
<b>17.170</b> F, FA, FL, FR, FRL	5,7	125	D 0226 MKF/170	11.86-07.89	6	<b>0 432 231 788</b>				
<b>17.192</b> F, FA	6,9	140	D 0826 LF01 <Z9500>	07.90-06.93	6	<b>0 432 131 858</b>				
F, FA, FL	6,6	137	D 0826 TF <Z9400>	08.88-06.90	6	<b>0 432 131 861</b>				
F, FA, FL, FR	5,7	141	D 0226 MKF	11.86-07.89	6	<b>0 432 231 788</b>				
FA, FL	6,9	140	D 0826 LF05 <Z9500, Euro 1>; D 0826 LF07 <Z9500, Euro 1>	07.93-06.96	6	<b>0 432 131 820</b>	<b>0 986 430 257</b>			
FL	6,9	140	D 0826 LF01 <Z9500>	07.90-06.93	6	<b>0 432 131 858</b>				
				07.93-04.95	6	<b>0 432 131 820</b>	<b>0 986 430 257</b>			
<b>17.220</b> F, FA, FL	11,4	162	D 2566 MF/220	11.86-07.89	6	<b>0 432 231 776</b>				
<b>17.222</b> FA	6,9	162	D 0826 LF11 <Z9500, Euro 2>	05.94-06.96	6	<b>0 432 133 855</b>	<b>0 986 430 313</b>			
<b>17.232</b> F	6,9	160	D 0826 LF/217/Silent <Z9500>	05.90-04.92	6	<b>0 432 131 858</b>				
		169	D 0826 LF02 <Z9500>	08.88-06.93	6	<b>0 432 131 858</b>				
FA	6,9	169	D 0826 LF08 <Z9500, Euro 1>	05.94-06.96	6	<b>0 432 131 820</b>	<b>0 986 430 257</b>			
FA, FL	6,9	160	D 0826 LF/217/Silent <Z9500>	05.90-04.92	6	<b>0 432 131 858</b>				
				07.93-04.95	6	<b>0 432 131 820</b>	<b>0 986 430 257</b>			
		169	D 0826 LF02 <Z9500>	08.88-06.93	6	<b>0 432 131 858</b>				
				07.93-04.95	6	<b>0 432 131 820</b>	<b>0 986 430 257</b>			
				07.93-05.95	6	<b>0 432 131 820</b>	<b>0 986 430 257</b>			
			D 0826 LF06 <Z9500, Euro 1>	07.93-04.95	6	<b>0 432 131 820</b>	<b>0 986 430 257</b>			
				07.93-05.95	6	<b>0 432 131 820</b>	<b>0 986 430 257</b>			
<b>17.240</b> F, FA, FL, FR, H, HA	11,4	177	D 2566 M; D 2566 MF	11.86-05.90	6	<b>0 432 231 850</b>				
<b>17.272</b> FLS	6,9	198	D 0826 LF04 <Z9500, Euro 1>	07.93-05.95	6	<b>0 432 131 820</b>	<b>0 986 430 257</b>			
	10,0	198	D 2865 LF02 <V0700>	09.91-05.95	5	<b>0 432 131 831</b>	<b>0 986 430 228</b>			
<b>18t</b>										
<b>18.192</b> F, FL	6,9	140	D 0826 LF01 <Z9500>	09.90-06.93	6	<b>0 432 131 858</b>				
				07.93-05.94	6	<b>0 432 131 820</b>	<b>0 986 430 257</b>			
			D 0826 LF05 <Z9500, Euro 1>; D 0826 LF07 <Z9500, Euro 1>	07.93-06.96	6	<b>0 432 131 820</b>	<b>0 986 430 257</b>			
<b>18.222</b> F	6,9	162	D 0826 LF11 <Z9500, Euro 2>	05.94-06.96	6	<b>0 432 133 855</b>	<b>0 986 430 313</b>			





◀ MAN

<b>18.232</b> F, FL	6,9	169	D 0826 LF02 <Z9500>	09.90-06.93	6	<b>0 432 131 858</b>	
				07.93-05.94	6	<b>0 432 131 820</b>	<b>0 986 430 257</b>
			D 0826 LF06 <Z9500, Euro 1>; D 0826 LF08 <Z9500, Euro 1>	07.93-06.96	6	<b>0 432 131 820</b>	<b>0 986 430 257</b>
<b>18.262</b> F	6,9	191	D 0826 LF13 <Z9500, Euro 2>	08.95-06.96	6	<b>0 432 133 840</b>	
					6	<b>0 432 133 841<sup>1</sup></b>	
<b>18.272</b> F, FL	6,9	198	D 0826 LF04 <Z9500, Euro 1>	07.93-06.96	6	<b>0 432 131 820</b>	<b>0 986 430 257</b>
	10,0	198	D 2865 LF02 <V0700>	09.91-05.94	5	<b>0 432 131 831</b>	<b>0 986 430 228</b>
<b>19t</b>							
<b>19.240</b> F, FA, FL, H, HA	11,4	177	D 2566 M; D 2566 MF	11.76-02.89	6	<b>0 432 231 850</b>	
<b>19.281</b> H, HA	11,4	206	D 2566 MK/280	01.80-01.88 CSA	6	<b>0 432 231 839</b>	
<b>19.291</b> F, FA, FL	12,0	213	D 2866 LFZ/290 <Z6700>	09.85-08.88	6	<b>0 432 231 778</b>	<b>0 986 430 159</b>
<b>19.321</b> H, HA, U, UL	11,4	235	D 2566 MK <Z2200>; D 2566 MKUL	01.79-01.88 CSA	6	<b>0 432 231 839</b>	
<b>19.331</b> F, FA, FL, U, UL	12,0	243	D 2866 LFZ/330 <Z6700>; D 2866 LUL/330	09.85-07.89	6	<b>0 432 231 778</b>	<b>0 986 430 159</b>
<b>19.361</b> F, FA, FL, U, UL	12,0	265	D 2866 KFZ <Z5000>; D 2866 KUL/360 <Z5100, Euro 1>	09.83-07.89	6	<b>0 432 231 778</b>	<b>0 986 430 159</b>
<b>19.390</b> F, FL	17,4	287	D 2540 MTF/390	12.82-12.87	10	<b>0 432 231 784</b>	
<b>20t</b>							
<b>20.280</b> DFAEG	11,4	206	D 2566 MTFG	07.80-06.90 CSA	6	<b>0 432 231 839</b>	
<b>20.291</b> FVLS	12,0	213	D 2866 LFZ/290 <Z6700>	09.85-11.86	6	<b>0 432 231 778</b>	<b>0 986 430 159</b>
<b>20.331</b> FVLS	12,0	243	D 2866 LFZ/330 <Z6700>	09.85-11.86	6	<b>0 432 231 778</b>	<b>0 986 430 159</b>
<b>20.361</b> FVLS	12,0	265	D 2866 KF <Z7500>	09.83-11.86	6	<b>0 432 231 778</b>	<b>0 986 430 159</b>
<b>22t</b>							
<b>22.220</b> FNL	11,4	162	D 2566 MF/220	10.83-11.86	6	<b>0 432 231 776</b>	
<b>22.240</b> FNL, FVL, H	11,4	177	D 2566 M; D 2566 MF	11.76-12.88	6	<b>0 432 231 850</b>	
<b>22.291</b> FNL	12,0	213	D 2866 LFZ/290 <Z6700>	09.85-11.86	6	<b>0 432 231 778</b>	<b>0 986 430 159</b>
<b>22.331</b> FNL, UNL, UNLW	12,0	243	D 2866 LFZ/330 <Z6700>; D 2866 LU/330	09.85-11.86	6	<b>0 432 231 778</b>	<b>0 986 430 159</b>
<b>22.361</b> FNL, UNL, UNLW	12,0	265	D 2866 KF <Z7500>; D 2866 KUL/360 <Z5100, Euro 1>	09.83-11.86	6	<b>0 432 231 778</b>	<b>0 986 430 159</b>
<b>24t</b>							
<b>24.192</b> FVL	9,5	141	D 2565 MF	11.86-12.87	5	<b>0 432 231 850</b>	
FVL, FVL-KO	5,7	141	D 0226 MKF	05.87-12.90	6	<b>0 432 231 788</b>	
<b>24.220</b> FNL	11,4	162	D 2566 MF/220	11.86-08.88	6	<b>0 432 231 776</b>	
<b>24.240</b> FNL, FVL	11,4	177	D 2566 MF	11.86-08.88	6	<b>0 432 231 850</b>	
<b>24.291</b> FNL, FVL	12,0	213	D 2866 LFZ/290 <Z6700>	11.86-08.88	6	<b>0 432 231 778</b>	<b>0 986 430 159</b>
<b>24.331</b> FNL, FVL, UNL	12,0	243	D 2866 LFZ/330 <Z6700>; D 2866 LUL/330	11.86-07.89	6	<b>0 432 231 778</b>	<b>0 986 430 159</b>
<b>24.361</b> FNL, FVLS, UNL	12,0	265	D 2866 KFZ <Z5000>; D 2866 KUL/360 <Z5100, Euro 1>	11.86-07.89	6	<b>0 432 231 778</b>	<b>0 986 430 159</b>
<b>26t</b>							
<b>26.240</b> DF, DFK, DF-TM, DH, DHA	11,4	177	D 2566 M; D 2566 MF	01.77-08.88	6	<b>0 432 231 850</b>	
<b>26.281</b> DH, DHA	11,4	206	D 2566 MK/280	03.80-01.88 CSA	6	<b>0 432 231 839</b>	
<b>26.291</b> DF, DFA, DFLS	12,0	213	D 2866 LFZ/290 <Z6700>	09.85-02.89	6	<b>0 432 231 778</b>	<b>0 986 430 159</b>
<b>26.320</b> DF	15,9	235	D 2530 MF, MXF	07.72-01.86	10	<b>0 432 231 868</b>	
<b>26.321</b> DH, DHA	11,4	235	D 2566 MK <Z2200>	07.80-01.88 CSA	6	<b>0 432 231 839</b>	
<b>26.331</b> DF, DFA, DFLS	12,0	243	D 2866 LFZ/330 <Z6700>	09.85-02.89	6	<b>0 432 231 778</b>	<b>0 986 430 159</b>
<b>26.361</b> DF, DFA, DFLS	12,0	265	D 2866 KFZ <Z5000>	09.83-02.89	6	<b>0 432 231 778</b>	<b>0 986 430 159</b>
<b>26.365</b> DF, DFA	18,3	268	D 2840 MF	05.83-08.88	10	<b>0 432 231 795</b>	
<b>30t</b>							
<b>30.291</b> VF, VF-TM, VFA	12,0	213	D 2866 LFZ/290 <Z6700>	09.85-11.86	6	<b>0 432 231 778</b>	<b>0 986 430 159</b>
<b>30.331</b> VF, VFA	12,0	243	D 2866 LFZ/330 <Z6700>	09.85-11.86	6	<b>0 432 231 778</b>	<b>0 986 430 159</b>
<b>30.361</b> VF, VFA	12,0	265	D 2866 KFZ <Z5000>	09.85-11.86	6	<b>0 432 231 778</b>	<b>0 986 430 159</b>
<b>32t</b>							
<b>32.240</b> DF, DH, DHA	11,4	177	D 2566 M; D 2566 MF	01.77-08.88	6	<b>0 432 231 850</b>	
<b>32.281</b> DH, DHA	11,4	206	D 2566 MK/280	03.80-01.88 CSA	6	<b>0 432 231 839</b>	
<b>32.291</b> DF, DFA, VF, VFAK	12,0	213	D 2866 LFZ/290 <Z6700>	09.85-08.88	6	<b>0 432 231 778</b>	<b>0 986 430 159</b>
<b>32.321</b> DH, DHA	11,4	235	D 2566 MK <Z2200>	07.80-01.88 CSA	6	<b>0 432 231 839</b>	
<b>32.331</b> DF, DFA, VF, VFAK	12,0	243	D 2866 LFZ/330 <Z6700>	09.85-08.88	6	<b>0 432 231 778</b>	<b>0 986 430 159</b>
<b>32.361</b> DF, DFA, VF, VFAK	12,0	265	D 2866 KFZ <Z5000>	09.83-08.88	6	<b>0 432 231 778</b>	<b>0 986 430 159</b>
<b>32.365</b> DF, DFA	18,3	268	D 2840 MF	06.83-08.88	10	<b>0 432 231 795</b>	





<b>33t</b>									
33.331 VF	12,0	243	D 2866 LFZ/330 <Z7600>	09.85-02.90	6	0 432 231 778	0 986 430 159		
<b>40t</b>									
40.365 DF, DFA	18,3	268	D 2840 MF	04.83-11.87	10	0 432 231 795			
40.422 DF, DFA	12,0	309	D 2866 LF06 <Z7601>	12.91-10.92	6	0 432 131 831	0 986 430 228		
40.440 DF, DFA	17,4	324	D 2540 MTF	† 03.83-06.90	10	0 432 231 779			
				I 08.82-06.90	10	0 432 231 784			
40.462 DFA	18,3	338	D 2840 LF/460	07.89-02.90	10	0 432 231 767			
<b>41t</b>									
41.262 VF, VFA	10,0	191	D 2865 LF/260 <V0700>	07.89-02.90	5	0 430 233 028			
41.272 VF, VFA	10,0	198	D 2865 LF02 <V0700>	02.90-12.91	5	0 432 131 831	0 986 430 228		
41.322 VFA	10,0	235	D 2865 LF03 <V0700>	02.90-05.94	5	0 432 131 831	0 986 430 228		
41.332 VF, VFA	12,0	243	D 2866 LF/330	10.88-02.90	6	0 432 231 778	0 986 430 159		
41.361 VFS	12,0	265	D 2866 KFZ <Z5000>	01.85-09.90	6	0 432 231 778	0 986 430 159		
41.362 VF, VFA	12,0	265	D 2866 LXF; D 2866 LXF <Z7600>	10.88-02.90	6	0 432 131 853	0 986 430 196		
41.372 VF	12,0	272	D 2866 LF03 <Z7601>; D 2866 LF05 <Euro 1>	02.90-05.94	6	0 432 131 853	0 986 430 196		
41.422 VF	12,0	309	D 2866 LF06 <Z7601>; D 2866 LF09 <Z7601, Euro 1>	02.90-06.96	6	0 432 131 831	0 986 430 228		
<b>48t</b>									
48.292 VF	12,0	213	D 2866 LF/290	07.89-02.90	6	0 432 231 778	0 986 430 159		
48.331 VFAK	12,0	243	D 2866 LFZ/330 <Z7600>	09.85-06.90	6	0 432 231 778	0 986 430 159		
48.332 VF	12,0	243	D 2866 LF/330	07.89-02.90	6	0 432 231 778	0 986 430 159		
48.362 VF	12,0	265	D 2866 LXF <Z7600>	07.89-02.90	6	0 432 131 853	0 986 430 196		
48.462 VF	18,3	338	D 2840 LF/460	07.89-02.90	10	0 432 231 767			

**MAZ MINSK**

<b>Serie 100</b>									
105	6,4	205	OM 906 LA <Euro 3>						
			Komp.Nr. 505047/ 06	01.02→	TNK	6	0 432 191 304		
			Komp.Nr. 505047/21	01.02→	TNK	6	0 432 191 301		
			Komp.Nr. 505074/12	01.02→	TNK	6	0 432 193 481		
			Komp.Nr. 505074/15						
107	6,4	205	OM 906 LA <Euro 3>						
			Komp.Nr. 505047/ 06	01.02→	TNK	6	0 432 191 304		
			Komp.Nr. 505047/21	01.02→	TNK	6	0 432 191 301		
			Komp.Nr. 505074/12	01.02→	TNK	6	0 432 193 481		
			Komp.Nr. 505074/15						
<b>Serie 200</b>									
203	6,4	170	OM 906 LA <Euro 3>						
			Komp.Nr. 505047/12	01.02→	TNK	6	0 432 191 307		
			Komp.Nr. 505047/15						
		170/205	OM 906 LA <Euro 3>						
			Komp.Nr. 505047/ 06	01.02→	TNK	6	0 432 191 304		
		205	OM 906 LA <Euro 3>						
			Komp.Nr. 505047/21	01.02→	TNK	6	0 432 191 301		
			Komp.Nr. 505074/12	01.02→	TNK	6	0 432 193 481		
			Komp.Nr. 505074/15						
<b>25t</b>									
643069	12,0	301	D 2866 LF25 <Euro 3>	01.02→		6	0 432 191 418 <sup>1</sup>		
						6	0 432 191 419		
<b>33t</b>									
551669	12,0	301	D 2866 LF25 <Euro 3>	01.02→		6	0 432 191 418 <sup>1</sup>		
						6	0 432 191 419		





**MAZDA**

Pickup B						
2.2	2,2	52	S2		08.81-10.87	4 9 430 610 007
Serie E						
2.2 D, D 4WD	2,2	44-47	R2; R207; R254; R281; R284; R286; R293; R294; R296		01.84-04.97	4 9 430 610 055
T						
2.5 D	2,5	52	XA		05.82-05.86	4 9 430 610 011
3.0	3,0	50-66	HA		06.76-05.86	4 9 430 610 011
					05.86-12.86	4 9 430 610 019
3.5	3,5	66/77	SL; SLD		06.87-12.97	4 9 430 610 019
					04.84-12.96	4 9 430 610 034

**MERCEDES-BENZ**

Actros						
1831, L [SKN]	12,0	230	OM 541.920 <(501)LA Euro2>	Komp.Nr. 505126/01/02	09.96-09.03 TNK	6 0 432 191 589
				Komp.Nr. 505137/01/02		
				Komp.Nr. 505137/07	09.96-09.03 TNK	6 0 432 191 437
				Komp.Nr. 505137/08		
				Komp.Nr. 505137/18	09.96-09.03 TNK	6 0 432 193 459
				Komp.Nr. 505137/19		
AK [SKN]	11,9	230	OM 541.941 <(501)LA Euro3>	Komp.Nr. 505126/ 01	04.97-09.03 TNK	6 0 432 191 589
				Komp.Nr. 505137/ 03	04.97-09.03 TNK	6 0 432 191 446
				Komp.Nr. 505137/ 05	04.97-09.03 TNK	6 0 432 191 459
				Komp.Nr. 505137/10	04.97-09.03 TNK	6 0 432 191 384
				Komp.Nr. 505137/25	04.97-09.03 TNK	6 0 432 191 258
				Komp.Nr. 505137/27	04.97-09.03 TNK	6 0 432 191 348
	12,0	230	OM 541.926 <(501)LA Euro2>	Komp.Nr. 505126/01/02	04.97-09.03 TNK	6 0 432 191 589
				Komp.Nr. 505137/01/02		
				Komp.Nr. 505137/07	04.97-09.03 TNK	6 0 432 191 437
				Komp.Nr. 505137/08		
				Komp.Nr. 505137/18	04.97-09.03 TNK	6 0 432 193 459
				Komp.Nr. 505137/19		
L [SKN]	11,9	230	OM 541.940 <(501)LA Euro3>	Komp.Nr. 505126/ 01	09.96-09.03 TNK	6 0 432 191 589
				Komp.Nr. 505137/ 03	09.96-09.03 TNK	6 0 432 191 446
				Komp.Nr. 505137/ 05	09.96-09.03 TNK	6 0 432 191 459
				Komp.Nr. 505137/10	09.96-09.03 TNK	6 0 432 191 384
				Komp.Nr. 505137/25	09.96-09.03 TNK	6 0 432 191 258
				Komp.Nr. 505137/27	09.96-09.03 TNK	6 0 432 191 348
1835 [SKN]	11,9	260	OM 541.942 <(501)LA Euro3>	Komp.Nr. 505126/ 01	09.96-09.03 TNK	6 0 432 191 589
				Komp.Nr. 505137/ 03	09.96-09.03 TNK	6 0 432 191 446
				Komp.Nr. 505137/ 05	09.96-09.03 TNK	6 0 432 191 459
				Komp.Nr. 505137/10	09.96-09.03 TNK	6 0 432 191 384
				Komp.Nr. 505137/14	09.96-09.03 TNK	6 0 432 191 363
				Komp.Nr. 505137/25	09.96-09.03 TNK	6 0 432 191 258
			Komp.Nr. 505137/27	09.96-09.03 TNK	6 0 432 191 348	





<b>1835</b> , L [SKN]	12,0	260	OM 541.922 <(501)LA Euro2>					
			Komp.Nr. 505126/01/02	09.96-09.03	TNK	6	<b>0 432 191 589</b>	
			Komp.Nr. 505137/01/02					
			Komp.Nr. 505137/07	09.96-09.03	TNK	6	<b>0 432 191 437</b>	
			Komp.Nr. 505137/08					
			Komp.Nr. 505137/18	09.96-09.03	TNK	6	<b>0 432 193 459</b>	
AK [SKN]	11,9	260	OM 541.943 <(501)LA Euro3>					
			Komp.Nr. 505126/ 01	09.96-09.03	TNK	6	<b>0 432 191 589</b>	
			Komp.Nr. 505137/ 03	09.96-09.03	TNK	6	<b>0 432 191 446</b>	
			Komp.Nr. 505137 /05	09.96-09.03	TNK	6	<b>0 432 191 459</b>	
			Komp.Nr. 505137/10	09.96-09.03	TNK	6	<b>0 432 191 384</b>	
			Komp.Nr. 505137/14	09.96-09.03	TNK	6	<b>0 432 191 363</b>	
	12,0	260	OM 541.927 <(501)LA Euro2>					
			Komp.Nr. 505126/01/02	04.97-09.03	TNK	6	<b>0 432 191 589</b>	
			Komp.Nr. 505137/01/02					
			Komp.Nr. 505137/07	04.97-09.03	TNK	6	<b>0 432 191 437</b>	
			Komp.Nr. 505137/08					
			Komp.Nr. 505137/18	04.97-09.03	TNK	6	<b>0 432 193 459</b>	
<b>1840</b> [SKN]	11,9	290	OM 541.944 <(501)LA Euro3>					
			Komp.Nr. 505126/ 01	09.96-09.03	TNK	6	<b>0 432 191 589</b>	
			Komp.Nr. 505137/ 03	09.96-09.03	TNK	6	<b>0 432 191 446</b>	
			Komp.Nr. 505137 /05	09.96-09.03	TNK	6	<b>0 432 191 459</b>	
			Komp.Nr. 505137/10	09.96-09.03	TNK	6	<b>0 432 191 384</b>	
			Komp.Nr. 505137/14	09.96-09.03	TNK	6	<b>0 432 191 363</b>	
, L [SKN]	12,0	290	OM 541.923 <(501)LA Euro2>					
			Komp.Nr. 505126/01/02	09.96-09.03	TNK	6	<b>0 432 191 589</b>	
			Komp.Nr. 505137/01/02					
			Komp.Nr. 505137/07	09.96-09.03	TNK	6	<b>0 432 191 437</b>	
			Komp.Nr. 505137/08					
			Komp.Nr. 505137/18	09.96-09.03	TNK	6	<b>0 432 193 459</b>	
AK [SKN]	11,9	290	OM 541.945 <(501)LA Euro3>					
			Komp.Nr. 505126/ 01	09.96-09.03	TNK	6	<b>0 432 191 589</b>	
			Komp.Nr. 505137/ 03	09.96-09.03	TNK	6	<b>0 432 191 446</b>	
			Komp.Nr. 505137 /05	09.96-09.03	TNK	6	<b>0 432 191 459</b>	
			Komp.Nr. 505137/10	09.96-09.03	TNK	6	<b>0 432 191 384</b>	
			Komp.Nr. 505137/14	09.96-09.03	TNK	6	<b>0 432 191 363</b>	
	12,0	290	OM 541.924 <(501)LA Euro2>					
			Komp.Nr. 505126/01/02	04.97-09.03	TNK	6	<b>0 432 191 589</b>	
			Komp.Nr. 505137/01/02					
			Komp.Nr. 505137/07	04.97-09.03	TNK	6	<b>0 432 191 437</b>	
			Komp.Nr. 505137/08					
			Komp.Nr. 505137/18	04.97-09.03	TNK	6	<b>0 432 193 459</b>	
	12,0	290	Komp.Nr. 505137/19					
			Komp.Nr. 505137/31	04.97-09.03	TNK	6	<b>0 432 193 459</b>	
			Komp.Nr. 505137/25	09.96-09.03	TNK	6	<b>0 432 191 258</b>	
	12,0	290	Komp.Nr. 505137/27	09.96-09.03	TNK	6	<b>0 432 191 348</b>	
			Komp.Nr. 505137/27	09.96-09.03	TNK	6	<b>0 432 191 348</b>	
			Komp.Nr. 505137/27	09.96-09.03	TNK	6	<b>0 432 191 348</b>	





◀ MERCEDES-BENZ

<b>1843</b> [SKN]	11,9	315	OM 541.946 <(501)LA Euro3>					
			Komp.Nr. 505126/ 01	09.96-09.03	TNK	6	<b>0 432 191 589</b>	
			Komp.Nr. 505137/ 03	09.96-09.03	TNK	6	<b>0 432 191 446</b>	
			Komp.Nr. 505137 /05	09.96-09.03	TNK	6	<b>0 432 191 459</b>	
			Komp.Nr. 505137/10	09.96-09.03	TNK	6	<b>0 432 191 384</b>	
			Komp.Nr. 505137/14	09.96-09.03	TNK	6	<b>0 432 191 363</b>	
			Komp.Nr. 505137/25	09.96-09.03	TNK	6	<b>0 432 191 258</b>	
			Komp.Nr. 505137/27	09.96-09.03	TNK	6	<b>0 432 191 348</b>	
, L [SKN]	12,0	315	OM 541.925 <(501)LA Euro2>					
			Komp.Nr. 505126/01/02	09.96-09.03	TNK	6	<b>0 432 191 589</b>	
			Komp.Nr. 505137/01/02					
			Komp.Nr. 505137/07	09.96-09.03	TNK	6	<b>0 432 191 437</b>	
			Komp.Nr. 505137/08					
			Komp.Nr. 505137/18	09.96-09.03	TNK	6	<b>0 432 193 459</b>	
			Komp.Nr. 505137/19					
			Komp.Nr. 505137/31	09.96-09.03	TNK	6	<b>0 432 193 459</b>	
AK [SKN]	12,0	315	OM 541.921 <(501)LA Euro2>					
			Komp.Nr. 505126/01/02	04.97-09.03	TNK	6	<b>0 432 191 589</b>	
			Komp.Nr. 505137/01/02					
			Komp.Nr. 505137/07	04.97-09.03	TNK	6	<b>0 432 191 437</b>	
			Komp.Nr. 505137/08					
			Komp.Nr. 505137/18	04.97-09.03	TNK	6	<b>0 432 193 459</b>	
			Komp.Nr. 505137/19					
			Komp.Nr. 505137/31	04.97-09.03	TNK	6	<b>0 432 193 459</b>	
<b>1848</b> [SKN]	15,9	350	OM 542.940 <(502)LA Euro3>					
			Komp.Nr. 505126/ 02	09.96-09.03	TNK	8	<b>0 432 191 589</b>	
			Komp.Nr. 505137/ 04	09.96-09.03	TNK	8	<b>0 432 191 446</b>	
			Komp.Nr. 505137 /06	09.96-09.03	TNK	8	<b>0 432 191 459</b>	
			Komp.Nr. 505137 /28	09.96-09.03		8	<b>0 432 191 348</b>	
			Komp.Nr. 505137/11	09.96-09.03	TNK	8	<b>0 432 191 384</b>	
			Komp.Nr. 505137/26	09.96-09.03	TNK	8	<b>0 432 191 258</b>	
, L [SKN]	16,0	350	OM 542.921 <(502)LA Euro2>					
			Komp.Nr. 505126/01/02	09.96-09.03	TNK	8	<b>0 432 191 589</b>	
			Komp.Nr. 505137/01/02					
			Komp.Nr. 505137/07	09.96-09.03	TNK	8	<b>0 432 191 437</b>	
			Komp.Nr. 505137/08					
			Komp.Nr. 505137/18	09.96-09.03	TNK	8	<b>0 432 193 459</b>	
			Komp.Nr. 505137/19					
			Komp.Nr. 505137/31	09.96-09.03	TNK	8	<b>0 432 193 459</b>	
AK [SKN]	15,9	350	OM 542.941 <(502)LA Euro3>					
			Komp.Nr. 505126/ 02	09.96-09.03	TNK	8	<b>0 432 191 589</b>	
			Komp.Nr. 505137/ 04	09.96-09.03	TNK	8	<b>0 432 191 446</b>	
			Komp.Nr. 505137 /06	09.96-09.03	TNK	8	<b>0 432 191 459</b>	
			Komp.Nr. 505137 /28	09.96-09.03		8	<b>0 432 191 348</b>	
			Komp.Nr. 505137/11	09.96-09.03	TNK	8	<b>0 432 191 384</b>	
			Komp.Nr. 505137/26	09.96-09.03	TNK	8	<b>0 432 191 258</b>	
	16,0	350	OM 542.925 <(502)LA Euro2>					
			Komp.Nr. 505126/01/02	04.97-09.03	TNK	8	<b>0 432 191 589</b>	
			Komp.Nr. 505137/01/02					
			Komp.Nr. 505137/07	04.97-09.03	TNK	8	<b>0 432 191 437</b>	
			Komp.Nr. 505137/08					
			Komp.Nr. 505137/18	04.97-09.03	TNK	8	<b>0 432 193 459</b>	
			Komp.Nr. 505137/19					
			Komp.Nr. 505137/31	04.97-09.03	TNK	8	<b>0 432 193 459</b>	
<b>1853</b> [SKN]	15,9	390	OM 542.942 <(502)LA Euro3>					
			Komp.Nr. 505126/ 02	09.96-09.03	TNK	8	<b>0 432 191 589</b>	
			Komp.Nr. 505137/ 04	09.96-09.03	TNK	8	<b>0 432 191 446</b>	
			Komp.Nr. 505137 /06	09.96-09.03	TNK	8	<b>0 432 191 459</b>	
			Komp.Nr. 505137 /28	09.96-09.03		8	<b>0 432 191 348</b>	
			Komp.Nr. 505137/11	09.96-09.03	TNK	8	<b>0 432 191 384</b>	
			Komp.Nr. 505137/15	09.96-09.03	TNK	8	<b>0 432 191 363</b>	
			Komp.Nr. 505137/26	09.96-09.03	TNK	8	<b>0 432 191 258</b>	







<b>1853</b> , L [SKN]	16,0	390	OM 542.920 <(502)LA Euro2>						
			Komp.Nr. 505126/01/02	09.96-09.03	TNK	8	<b>0 432 191 589</b>		
			Komp.Nr. 505137/01/02						
			Komp.Nr. 505137/07	09.96-09.03	TNK	8	<b>0 432 191 437</b>		
			Komp.Nr. 505137/08						
			Komp.Nr. 505137/18	09.96-09.03	TNK	8	<b>0 432 193 459</b>		
AK [SKN]	15,9	390	OM 542.943 <(502)LA Euro2>						
			Komp.Nr. 505126/ 02	09.96-09.03	TNK	8	<b>0 432 191 589</b>		
			Komp.Nr. 505137/ 04	09.96-09.03	TNK	8	<b>0 432 191 446</b>		
			Komp.Nr. 505137 /06	09.96-09.03	TNK	8	<b>0 432 191 459</b>		
			Komp.Nr. 505137 /28	09.96-09.03		8	<b>0 432 191 348</b>		
			Komp.Nr. 505137/11	09.96-09.03	TNK	8	<b>0 432 191 384</b>		
<b>1857</b> L [SKN]	15,9	420	OM 542.944 <(502)LA Euro3>						
			Komp.Nr. 505126/ 02	09.96-09.03	TNK	8	<b>0 432 191 589</b>		
			Komp.Nr. 505137/ 04	09.96-09.03	TNK	8	<b>0 432 191 446</b>		
			Komp.Nr. 505137 /06	09.96-09.03	TNK	8	<b>0 432 191 459</b>		
			Komp.Nr. 505137 /28	09.96-09.03		8	<b>0 432 191 348</b>		
			Komp.Nr. 505137/11	09.96-09.03	TNK	8	<b>0 432 191 384</b>		
AK,AS [SKN]	16,0	420	OM 542.922 <(502)LA Euro2>						
			Komp.Nr. 505126/01/02	04.97-09.03	TNK	8	<b>0 432 191 589</b>		
			Komp.Nr. 505137/01/02						
			Komp.Nr. 505137/07	04.97-09.03	TNK	8	<b>0 432 191 437</b>		
			Komp.Nr. 505137/08						
			Komp.Nr. 505137/18	04.97-09.03	TNK	8	<b>0 432 193 459</b>		
	2031 [SKN]	11,9	230	OM 541.940 <(501)LA Euro3>					
				Komp.Nr. 505126/ 01	09.96-09.03	TNK	6	<b>0 432 191 589</b>	
				Komp.Nr. 505137/ 03	09.96-09.03	TNK	6	<b>0 432 191 446</b>	
				Komp.Nr. 505137 /05	09.96-09.03	TNK	6	<b>0 432 191 459</b>	
				Komp.Nr. 505137/10	09.96-09.03	TNK	6	<b>0 432 191 384</b>	
				Komp.Nr. 505137/25	09.96-09.03	TNK	6	<b>0 432 191 258</b>	
A [SKN]	12,0	230	OM 541.920 <(501)LA Euro2>						
			Komp.Nr. 505126/01/02	09.96-09.03	TNK	6	<b>0 432 191 589</b>		
			Komp.Nr. 505137/01/02						
			Komp.Nr. 505137/07	09.96-09.03	TNK	6	<b>0 432 191 437</b>		
			Komp.Nr. 505137/08						
			Komp.Nr. 505137/18	09.96-09.03	TNK	6	<b>0 432 193 459</b>		
AK,AS [SKN]	11,9	230	OM 541.941 <(501)LA Euro3>						
			Komp.Nr. 505126/ 01	09.96-09.03	TNK	6	<b>0 432 191 589</b>		
			Komp.Nr. 505137/ 03	09.96-09.03	TNK	6	<b>0 432 191 446</b>		
			Komp.Nr. 505137 /05	09.96-09.03	TNK	6	<b>0 432 191 459</b>		
			Komp.Nr. 505137/10	09.96-09.03	TNK	6	<b>0 432 191 384</b>		
			Komp.Nr. 505137/25	09.96-09.03	TNK	6	<b>0 432 191 258</b>		
A [SKN]	12,0	230	OM 541.926 <(501)LA Euro2>						
			Komp.Nr. 505126/01/02	09.96-09.03	TNK	6	<b>0 432 191 589</b>		
			Komp.Nr. 505137/01/02						
			Komp.Nr. 505137/07	09.96-09.03	TNK	6	<b>0 432 191 437</b>		
			Komp.Nr. 505137/08						
			Komp.Nr. 505137/18	09.96-09.03	TNK	6	<b>0 432 193 459</b>		





◀ MERCEDES-BENZ

2035 [SKN]	11,9 260	OM 541.942 <(501)LA Euro3>				
		Komp.Nr. 505126/ 01	04.97-09.03	TNK	6	<b>0 432 191 589</b>
		Komp.Nr. 505137/ 03	04.97-09.03	TNK	6	<b>0 432 191 446</b>
		Komp.Nr. 505137 /05	04.97-09.03	TNK	6	<b>0 432 191 459</b>
		Komp.Nr. 505137/10	04.97-09.03	TNK	6	<b>0 432 191 384</b>
		Komp.Nr. 505137/14	04.97-09.03	TNK	6	<b>0 432 191 363</b>
		Komp.Nr. 505137/25	04.97-09.03	TNK	6	<b>0 432 191 258</b>
		Komp.Nr. 505137/27	04.97-09.03	TNK	6	<b>0 432 191 348</b>
12,0 260	OM 541.927 <(501)LA Euro2>					
	Komp.Nr. 505126/01/02	04.97-09.03	TNK	6	<b>0 432 191 589</b>	
	Komp.Nr. 505137/01/02					
	Komp.Nr. 505137/07	04.97-09.03	TNK	6	<b>0 432 191 437</b>	
	Komp.Nr. 505137/08					
	Komp.Nr. 505137/18	04.97-09.03	TNK	6	<b>0 432 193 459</b>	
	Komp.Nr. 505137/19					
	Komp.Nr. 505137/31	04.97-09.03	TNK	6	<b>0 432 193 459</b>	
2040 [SKN]	11,9 290	OM 541.944 <(501)LA Euro3>				
		Komp.Nr. 505126/ 01	11.97-09.03	TNK	6	<b>0 432 191 589</b>
		Komp.Nr. 505137/ 03	11.97-09.03	TNK	6	<b>0 432 191 446</b>
		Komp.Nr. 505137 /05	11.97-09.03	TNK	6	<b>0 432 191 459</b>
		Komp.Nr. 505137/10	11.97-09.03	TNK	6	<b>0 432 191 384</b>
		Komp.Nr. 505137/14	11.97-09.03	TNK	6	<b>0 432 191 363</b>
		Komp.Nr. 505137/25	11.97-09.03	TNK	6	<b>0 432 191 258</b>
		Komp.Nr. 505137/27	11.97-09.03	TNK	6	<b>0 432 191 348</b>
12,0 290	OM 541.923 <(501)LA Euro2>					
	Komp.Nr. 505126/01/02	09.96-09.03	TNK	6	<b>0 432 191 589</b>	
	Komp.Nr. 505137/01/02					
	Komp.Nr. 505137/07	09.96-09.03	TNK	6	<b>0 432 191 437</b>	
	Komp.Nr. 505137/08					
	Komp.Nr. 505137/18	09.96-09.03	TNK	6	<b>0 432 193 459</b>	
	Komp.Nr. 505137/19					
	Komp.Nr. 505137/31	09.96-09.03	TNK	6	<b>0 432 193 459</b>	
A [SKN]	12,0 290	OM 541.924 <(501)LA Euro2>				
		Komp.Nr. 505126/01/02	09.96-09.03	TNK	6	<b>0 432 191 589</b>
		Komp.Nr. 505137/01/02				
		Komp.Nr. 505137/07	09.96-09.03	TNK	6	<b>0 432 191 437</b>
		Komp.Nr. 505137/08				
		Komp.Nr. 505137/18	09.96-09.03	TNK	6	<b>0 432 193 459</b>
		Komp.Nr. 505137/19				
		Komp.Nr. 505137/31	09.96-09.03	TNK	6	<b>0 432 193 459</b>
AK,AS [SKN]	11,9 290	OM 541.945 <(501)LA Euro3>				
		Komp.Nr. 505126/ 01	11.97-09.03	TNK	6	<b>0 432 191 589</b>
		Komp.Nr. 505137/ 03	11.97-09.03	TNK	6	<b>0 432 191 446</b>
		Komp.Nr. 505137 /05	11.97-09.03	TNK	6	<b>0 432 191 459</b>
		Komp.Nr. 505137/10	11.97-09.03	TNK	6	<b>0 432 191 384</b>
		Komp.Nr. 505137/14	11.97-09.03	TNK	6	<b>0 432 191 363</b>
		Komp.Nr. 505137/25	11.97-09.03	TNK	6	<b>0 432 191 258</b>
		Komp.Nr. 505137/27	11.97-09.03	TNK	6	<b>0 432 191 348</b>
2043 AS [SKN]	11,9 315	OM 541.947 <(501)LA Euro3>				
		Komp.Nr. 505126/ 01	09.98-09.03	TNK	6	<b>0 432 191 589</b>
		Komp.Nr. 505137/ 03	09.98-09.03	TNK	6	<b>0 432 191 446</b>
		Komp.Nr. 505137 /05	09.98-09.03	TNK	6	<b>0 432 191 459</b>
		Komp.Nr. 505137/10	09.98-09.03	TNK	6	<b>0 432 191 384</b>
		Komp.Nr. 505137/14	09.98-09.03	TNK	6	<b>0 432 191 363</b>
		Komp.Nr. 505137/25	09.98-09.03	TNK	6	<b>0 432 191 258</b>
		Komp.Nr. 505137/27	09.98-09.03	TNK	6	<b>0 432 191 348</b>





<b>2043 AS</b> [SKN]	12,0	315	OM 541.921 <(501)LA>				
			Komp.Nr. 505126/01/02	09.96-09.03	TNK	6	<b>0 432 191 589</b>
			Komp.Nr. 505137/01/02				
			Komp.Nr. 505137/07	09.96-09.03	TNK	6	<b>0 432 191 437</b>
			Komp.Nr. 505137/08				
			Komp.Nr. 505137/18	09.96-09.03	TNK	6	<b>0 432 193 459</b>
<b>2048 AS</b> [SKN]	15,9	350	OM 542.925 <(502)LA>				
			Komp.Nr. 505126/01/02	09.96-09.03	TNK	6	<b>0 432 191 589</b>
			Komp.Nr. 505137/01/02				
			Komp.Nr. 505137/07	09.96-09.03	TNK	6	<b>0 432 191 437</b>
			Komp.Nr. 505137/08				
			Komp.Nr. 505137/18	09.96-09.03	TNK	6	<b>0 432 193 459</b>
<b>2053</b> [SKN]	12,0	390	OM 542.926 <(501)LA Euro2>				
			Komp.Nr. 505126/01/02	09.96-09.03	TNK	8	<b>0 432 191 589</b>
			Komp.Nr. 505137/01/02				
			Komp.Nr. 505137/07	09.96-09.03	TNK	8	<b>0 432 191 437</b>
			Komp.Nr. 505137/08				
			Komp.Nr. 505137/18	09.96-09.03	TNK	8	<b>0 432 193 459</b>
			Komp.Nr. 505137/19				
			Komp.Nr. 505137/31	09.96-09.03	TNK	8	<b>0 432 193 459</b>
			OM 542.941 <(502)LA Euro3>				
			Komp.Nr. 505126/ 02	09.96-09.03	TNK	8	<b>0 432 191 589</b>
Komp.Nr. 505137/ 04	09.96-09.03	TNK	8	<b>0 432 191 446</b>			
Komp.Nr. 505137 /06	09.96-09.03	TNK	8	<b>0 432 191 459</b>			
Komp.Nr. 505137 /28	09.96-09.03		8	<b>0 432 191 348</b>			
Komp.Nr. 505137/11	09.96-09.03	TNK	8	<b>0 432 191 384</b>			
Komp.Nr. 505137/26	09.96-09.03	TNK	8	<b>0 432 191 258</b>			
<b>2531</b> [SKN]	11,9	230	OM 541.940 <(501)LA Euro3>				
			Komp.Nr. 505126/ 01	09.96-09.03	TNK	6	<b>0 432 191 589</b>
			Komp.Nr. 505137/ 03	09.96-09.03	TNK	6	<b>0 432 191 446</b>
			Komp.Nr. 505137 /05	09.96-09.03	TNK	6	<b>0 432 191 459</b>
			Komp.Nr. 505137/10	09.96-09.03	TNK	6	<b>0 432 191 384</b>
			Komp.Nr. 505137/25	09.96-09.03	TNK	6	<b>0 432 191 258</b>
, L [SKN]	12,0	230	OM 541.920 <(501)LA Euro2>				
			Komp.Nr. 505126/01/02	09.96-09.03	TNK	6	<b>0 432 191 589</b>
			Komp.Nr. 505137/01/02				
			Komp.Nr. 505137/07	09.96-09.03	TNK	6	<b>0 432 191 437</b>
			Komp.Nr. 505137/08				
			Komp.Nr. 505137/18	09.96-09.03	TNK	6	<b>0 432 193 459</b>
<b>2535</b> [SKN]	11,9	260	OM 541.942 <(501)LA Euro3>				
			Komp.Nr. 505126/ 01	09.96-09.03	TNK	6	<b>0 432 191 589</b>
			Komp.Nr. 505137/ 03	09.96-09.03	TNK	6	<b>0 432 191 446</b>
			Komp.Nr. 505137 /05	09.96-09.03	TNK	6	<b>0 432 191 459</b>
			Komp.Nr. 505137/10	09.96-09.03	TNK	6	<b>0 432 191 384</b>
			Komp.Nr. 505137/14	09.96-09.03	TNK	6	<b>0 432 191 363</b>
L [SKN]	12,0	260	OM 541.922 <(501)LA Euro2>				
			Komp.Nr. 505126/01/02	09.96-09.03	TNK	6	<b>0 432 191 589</b>
			Komp.Nr. 505137/01/02				
			Komp.Nr. 505137/07	09.96-09.03	TNK	6	<b>0 432 191 437</b>
			Komp.Nr. 505137/08				
			Komp.Nr. 505137/18	09.96-09.03	TNK	6	<b>0 432 193 459</b>
			Komp.Nr. 505137/19				
			Komp.Nr. 505137/31	09.96-09.03	TNK	6	<b>0 432 193 459</b>





◀ MERCEDES-BENZ

2540 [SKN]	11,9	290	OM 541.944 <(501)LA Euro3>				
			Komp.Nr. 505126/ 01	09.96-09.03	TNK	6	<b>0 432 191 589</b>
			Komp.Nr. 505137/ 03	09.96-09.03	TNK	6	<b>0 432 191 446</b>
			Komp.Nr. 505137 /05	09.96-09.03	TNK	6	<b>0 432 191 459</b>
			Komp.Nr. 505137/10	09.96-09.03	TNK	6	<b>0 432 191 384</b>
			Komp.Nr. 505137/14	09.96-09.03	TNK	6	<b>0 432 191 363</b>
			Komp.Nr. 505137/25	09.96-09.03	TNK	6	<b>0 432 191 258</b>
			Komp.Nr. 505137/27	09.96-09.03	TNK	6	<b>0 432 191 348</b>
, L [SKN]	12,0	290	OM 541.923 <(501)LA Euro2>				
			Komp.Nr. 505126/01/02	09.96-09.03	TNK	6	<b>0 432 191 589</b>
			Komp.Nr. 505137/01/02				
			Komp.Nr. 505137/07	09.96-09.03	TNK	6	<b>0 432 191 437</b>
			Komp.Nr. 505137/08				
			Komp.Nr. 505137/18	09.96-09.03	TNK	6	<b>0 432 193 459</b>
			Komp.Nr. 505137/19				
			Komp.Nr. 505137/31	09.96-09.03	TNK	6	<b>0 432 193 459</b>
2543 [SKN]	11,9	315	OM 541.946 <(501)LA Euro3>				
			Komp.Nr. 505126/ 01	09.96-09.03	TNK	6	<b>0 432 191 589</b>
			Komp.Nr. 505137/ 03	09.96-09.03	TNK	6	<b>0 432 191 446</b>
			Komp.Nr. 505137 /05	09.96-09.03	TNK	6	<b>0 432 191 459</b>
			Komp.Nr. 505137/10	09.96-09.03	TNK	6	<b>0 432 191 384</b>
			Komp.Nr. 505137/14	09.96-09.03	TNK	6	<b>0 432 191 363</b>
			Komp.Nr. 505137/25	09.96-09.03	TNK	6	<b>0 432 191 258</b>
			Komp.Nr. 505137/27	09.96-09.03	TNK	6	<b>0 432 191 348</b>
, L [SKN]	12,0	315	OM 541.925 <(501)LA Euro2>				
			Komp.Nr. 505126/01/02	09.96-09.03	TNK	6	<b>0 432 191 589</b>
			Komp.Nr. 505137/01/02				
			Komp.Nr. 505137/07	09.96-09.03	TNK	6	<b>0 432 191 437</b>
			Komp.Nr. 505137/08				
			Komp.Nr. 505137/18	09.96-09.03	TNK	6	<b>0 432 193 459</b>
			Komp.Nr. 505137/19				
			Komp.Nr. 505137/31	09.96-09.03	TNK	6	<b>0 432 193 459</b>
2548 [SKN]	15,9	350	OM 542.940 <(502)LA Euro3>				
			Komp.Nr. 505126/ 02	09.96-09.03	TNK	8	<b>0 432 191 589</b>
			Komp.Nr. 505137/ 04	09.96-09.03	TNK	8	<b>0 432 191 446</b>
			Komp.Nr. 505137 /06	09.96-09.03	TNK	8	<b>0 432 191 459</b>
			Komp.Nr. 505137 /28	09.96-09.03		8	<b>0 432 191 348</b>
			Komp.Nr. 505137/11	09.96-09.03	TNK	8	<b>0 432 191 384</b>
			Komp.Nr. 505137/26	09.96-09.03	TNK	8	<b>0 432 191 258</b>
, L [SKN]	16,0	350	OM 542.921 <(502)LA Euro2>				
			Komp.Nr. 505126/01/02	09.96-09.03	TNK	8	<b>0 432 191 589</b>
			Komp.Nr. 505137/01/02				
			Komp.Nr. 505137/07	09.96-09.03	TNK	8	<b>0 432 191 437</b>
			Komp.Nr. 505137/08				
			Komp.Nr. 505137/18	09.96-09.03	TNK	8	<b>0 432 193 459</b>
			Komp.Nr. 505137/19				
			Komp.Nr. 505137/31	09.96-09.03	TNK	8	<b>0 432 193 459</b>
2553 [SKN]	15,9	390	OM 542.942 <(502)LA Euro3>				
			Komp.Nr. 505126/ 02	09.96-09.03	TNK	8	<b>0 432 191 589</b>
			Komp.Nr. 505137/ 04	09.96-09.03	TNK	8	<b>0 432 191 446</b>
			Komp.Nr. 505137 /06	09.96-09.03	TNK	8	<b>0 432 191 459</b>
			Komp.Nr. 505137 /28	09.96-09.03		8	<b>0 432 191 348</b>
			Komp.Nr. 505137/11	09.96-09.03	TNK	8	<b>0 432 191 384</b>
			Komp.Nr. 505137/15	09.96-09.03	TNK	8	<b>0 432 191 363</b>
			Komp.Nr. 505137/26	09.96-09.03	TNK	8	<b>0 432 191 258</b>
, L [SKN]	16,0	390	OM 542.920 <(502)LA Euro2>				
			Komp.Nr. 505126/01/02	09.96-09.03	TNK	8	<b>0 432 191 589</b>
			Komp.Nr. 505137/01/02				
			Komp.Nr. 505137/07	09.96-09.03	TNK	8	<b>0 432 191 437</b>
			Komp.Nr. 505137/08				
			Komp.Nr. 505137/18	09.96-09.03	TNK	8	<b>0 432 193 459</b>
			Komp.Nr. 505137/19				
			Komp.Nr. 505137/31	09.96-09.03	TNK	8	<b>0 432 193 459</b>





2557 L [SKN]	15,9	420	OM 542.944 <(502)LA Euro3>					
			Komp.Nr. 505126/02	09.96-09.03	TNK	8	<b>0 432 191 589</b>	
			Komp.Nr. 505137/04	09.96-09.03	TNK	8	<b>0 432 191 446</b>	
			Komp.Nr. 505137/06	09.96-09.03	TNK	8	<b>0 432 191 459</b>	
			Komp.Nr. 505137/28	09.96-09.03		8	<b>0 432 191 348</b>	
			Komp.Nr. 505137/11	09.96-09.03	TNK	8	<b>0 432 191 384</b>	
			Komp.Nr. 505137/15	09.96-09.03	TNK	8	<b>0 432 191 363</b>	
			Komp.Nr. 505137/26	09.96-09.03	TNK	8	<b>0 432 191 258</b>	
, L [SKN]	16,0	420	OM 542.922 <(502)LA Euro2>					
			Komp.Nr. 505126/01/02	04.97-09.03	TNK	8	<b>0 432 191 589</b>	
			Komp.Nr. 505137/01/02					
			Komp.Nr. 505137/07	04.97-09.03	TNK	8	<b>0 432 191 437</b>	
			Komp.Nr. 505137/08					
			Komp.Nr. 505137/18	04.97-09.03	TNK	8	<b>0 432 193 459</b>	
			Komp.Nr. 505137/19					
			Komp.Nr. 505137/31	04.97-09.03	TNK	8	<b>0 432 193 459</b>	
2631 [SKN]	11,9	230	OM 541.940 <(501)LA Euro3>					
			Komp.Nr. 505126/01	04.97-09.03	TNK	6	<b>0 432 191 589</b>	
			Komp.Nr. 505137/03	04.97-09.03	TNK	6	<b>0 432 191 446</b>	
			Komp.Nr. 505137/05	04.97-09.03	TNK	6	<b>0 432 191 459</b>	
			Komp.Nr. 505137/10	04.97-09.03	TNK	6	<b>0 432 191 384</b>	
			Komp.Nr. 505137/25	04.97-09.03	TNK	6	<b>0 432 191 258</b>	
			Komp.Nr. 505137/27	04.97-09.03	TNK	6	<b>0 432 191 348</b>	
			, L [SKN]	12,0	230	OM 541.920 <(501)LA Euro2>		
Komp.Nr. 505126/01/02	04.97-09.03	TNK				6	<b>0 432 191 589</b>	
Komp.Nr. 505137/01/02								
Komp.Nr. 505137/07	04.97-09.03	TNK				6	<b>0 432 191 437</b>	
Komp.Nr. 505137/08								
Komp.Nr. 505137/18	04.97-09.03	TNK				6	<b>0 432 193 459</b>	
Komp.Nr. 505137/19								
Komp.Nr. 505137/31	04.97-09.03	TNK				6	<b>0 432 193 459</b>	
2635 [SKN]	11,9	260	OM 541.942 <(501)LA Euro3>					
			Komp.Nr. 505126/01	04.97-09.03	TNK	6	<b>0 432 191 589</b>	
			Komp.Nr. 505137/03	04.97-09.03	TNK	6	<b>0 432 191 446</b>	
			Komp.Nr. 505137/05	04.97-09.03	TNK	6	<b>0 432 191 459</b>	
			Komp.Nr. 505137/10	04.97-09.03	TNK	6	<b>0 432 191 384</b>	
			Komp.Nr. 505137/14	04.97-09.03	TNK	6	<b>0 432 191 363</b>	
			Komp.Nr. 505137/25	04.97-09.03	TNK	6	<b>0 432 191 258</b>	
			Komp.Nr. 505137/27	04.97-09.03	TNK	6	<b>0 432 191 348</b>	
, L [SKN]	12,0	260	OM 541.922 <(501)LA Euro2>					
			Komp.Nr. 505126/01/02	04.97-09.03	TNK	6	<b>0 432 191 589</b>	
			Komp.Nr. 505137/01/02					
			Komp.Nr. 505137/07	04.97-09.03	TNK	6	<b>0 432 191 437</b>	
			Komp.Nr. 505137/08					
			Komp.Nr. 505137/18	04.97-09.03	TNK	6	<b>0 432 193 459</b>	
			Komp.Nr. 505137/19					
			Komp.Nr. 505137/31	04.97-09.03	TNK	6	<b>0 432 193 459</b>	
2640 [SKN]	11,9	290	OM 541.944 <(501)LA Euro2>					
			Komp.Nr. 505126/01	09.96-09.03	TNK	6	<b>0 432 191 589</b>	
			Komp.Nr. 505137/03	09.96-09.03	TNK	6	<b>0 432 191 446</b>	
			Komp.Nr. 505137/05	09.96-09.03	TNK	6	<b>0 432 191 459</b>	
			Komp.Nr. 505137/10	09.96-09.03	TNK	6	<b>0 432 191 384</b>	
			Komp.Nr. 505137/14	09.96-09.03	TNK	6	<b>0 432 191 363</b>	
			Komp.Nr. 505137/25	09.96-09.03	TNK	6	<b>0 432 191 258</b>	
			Komp.Nr. 505137/27	09.96-09.03	TNK	6	<b>0 432 191 348</b>	
, L [SKN]	12,0	290	OM 541.923 <(501)LA Euro2>					
			Komp.Nr. 505126/01/02	09.96-09.03	TNK	6	<b>0 432 191 589</b>	
			Komp.Nr. 505137/01/02					
			Komp.Nr. 505137/07	09.96-09.03	TNK	6	<b>0 432 191 437</b>	
			Komp.Nr. 505137/08					
			Komp.Nr. 505137/18	09.96-09.03	TNK	6	<b>0 432 193 459</b>	
			Komp.Nr. 505137/19					
			Komp.Nr. 505137/31	09.96-09.03	TNK	6	<b>0 432 193 459</b>	





◀ MERCEDES-BENZ

<b>2643</b> [SKN]	11,9	315	OM 541.946 <(501)LA Euro3>					
			Komp.Nr. 505126/ 01	09.96-09.03	TNK	6	<b>0 432 191 589</b>	
			Komp.Nr. 505137/ 03	09.96-09.03	TNK	6	<b>0 432 191 446</b>	
			Komp.Nr. 505137 /05	09.96-09.03	TNK	6	<b>0 432 191 459</b>	
			Komp.Nr. 505137/10	09.96-09.03	TNK	6	<b>0 432 191 384</b>	
			Komp.Nr. 505137/14	09.96-09.03	TNK	6	<b>0 432 191 363</b>	
			Komp.Nr. 505137/25	09.96-09.03	TNK	6	<b>0 432 191 258</b>	
			Komp.Nr. 505137/27	09.96-09.03	TNK	6	<b>0 432 191 348</b>	
, L [SKN]	12,0	315	OM 541.925 <(501)LA Euro2>					
			Komp.Nr. 505126/01/02	09.96-09.03	TNK	6	<b>0 432 191 589</b>	
			Komp.Nr. 505137/01/02					
			Komp.Nr. 505137/07	09.96-09.03	TNK	6	<b>0 432 191 437</b>	
			Komp.Nr. 505137/08					
			Komp.Nr. 505137/18	09.96-09.03	TNK	6	<b>0 432 193 459</b>	
			Komp.Nr. 505137/19					
			Komp.Nr. 505137/31	09.96-09.03	TNK	6	<b>0 432 193 459</b>	
<b>2648</b> [SKN]	15,9	350	OM 542.940 <(502)LA Euro3>					
			Komp.Nr. 505126/ 02	09.96-09.03	TNK	8	<b>0 432 191 589</b>	
			Komp.Nr. 505137/ 04	09.96-09.03	TNK	8	<b>0 432 191 446</b>	
			Komp.Nr. 505137 /06	09.96-09.03	TNK	8	<b>0 432 191 459</b>	
			Komp.Nr. 505137 /28	09.96-09.03		8	<b>0 432 191 348</b>	
			Komp.Nr. 505137/11	09.96-09.03	TNK	8	<b>0 432 191 384</b>	
			Komp.Nr. 505137/26	09.96-09.03	TNK	8	<b>0 432 191 258</b>	
, L [SKN]	16,0	350	OM 542.921 <(502)LA Euro2>					
			Komp.Nr. 505126/01/02	09.96-09.03	TNK	8	<b>0 432 191 589</b>	
			Komp.Nr. 505137/01/02					
			Komp.Nr. 505137/07	09.96-09.03	TNK	8	<b>0 432 191 437</b>	
			Komp.Nr. 505137/08					
			Komp.Nr. 505137/18	09.96-09.03	TNK	8	<b>0 432 193 459</b>	
			Komp.Nr. 505137/19					
			Komp.Nr. 505137/31	09.96-09.03	TNK	8	<b>0 432 193 459</b>	
<b>2653</b> [SKN]	15,9	390	OM 542.942 <(502)LA Euro3>					
			Komp.Nr. 505126/ 02	09.96-09.03	TNK	8	<b>0 432 191 589</b>	
			Komp.Nr. 505137/ 04	09.96-09.03	TNK	8	<b>0 432 191 446</b>	
			Komp.Nr. 505137 /06	09.96-09.03	TNK	8	<b>0 432 191 459</b>	
			Komp.Nr. 505137 /28	09.96-09.03		8	<b>0 432 191 348</b>	
			Komp.Nr. 505137/11	09.96-09.03	TNK	8	<b>0 432 191 384</b>	
			Komp.Nr. 505137/15	09.96-09.03	TNK	8	<b>0 432 191 363</b>	
			Komp.Nr. 505137/26	09.96-09.03	TNK	8	<b>0 432 191 258</b>	
, L [SKN]	16,0	390	OM 542.920 <(502)LA Euro2>					
			Komp.Nr. 505126/01/02	09.96-09.03	TNK	8	<b>0 432 191 589</b>	
			Komp.Nr. 505137/01/02					
			Komp.Nr. 505137/07	09.96-09.03	TNK	8	<b>0 432 191 437</b>	
			Komp.Nr. 505137/08					
			Komp.Nr. 505137/18	09.96-09.03	TNK	8	<b>0 432 193 459</b>	
			Komp.Nr. 505137/19					
			Komp.Nr. 505137/31	09.96-09.03	TNK	8	<b>0 432 193 459</b>	
<b>2657</b> [SKN]	15,9	420	OM 542.944 <(502)LA Euro3>					
			Komp.Nr. 505126/ 02	09.96-09.03	TNK	8	<b>0 432 191 589</b>	
			Komp.Nr. 505137/ 04	09.96-09.03	TNK	8	<b>0 432 191 446</b>	
			Komp.Nr. 505137 /06	09.96-09.03	TNK	8	<b>0 432 191 459</b>	
			Komp.Nr. 505137 /28	09.96-09.03		8	<b>0 432 191 348</b>	
			Komp.Nr. 505137/11	09.96-09.03	TNK	8	<b>0 432 191 384</b>	
			Komp.Nr. 505137/15	09.96-09.03	TNK	8	<b>0 432 191 363</b>	
			Komp.Nr. 505137/26	09.96-09.03	TNK	8	<b>0 432 191 258</b>	
, L [SKN]	16,0	420	OM 542.922 <(502)LA Euro2>					
			Komp.Nr. 505126/01/02	04.97-09.03	TNK	8	<b>0 432 191 589</b>	
			Komp.Nr. 505137/01/02					
			Komp.Nr. 505137/07	04.97-09.03	TNK	8	<b>0 432 191 437</b>	
			Komp.Nr. 505137/08					
			Komp.Nr. 505137/18	04.97-09.03	TNK	8	<b>0 432 193 459</b>	
			Komp.Nr. 505137/19					
			Komp.Nr. 505137/31	04.97-09.03	TNK	8	<b>0 432 193 459</b>	





3231 [SKN]	12,0	230	OM 541.920 <(501)LA Euro2>				
			Komp.Nr. 505126/01/02	04.97-09.03	TNK	6	<b>0 432 191 589</b>
			Komp.Nr. 505137/01/02				
			Komp.Nr. 505137/07	04.97-09.03	TNK	6	<b>0 432 191 437</b>
			Komp.Nr. 505137/08				
			Komp.Nr. 505137/18	04.97-09.03	TNK	6	<b>0 432 193 459</b>
3235 [SKN]	12,0	260	OM 541.922 <(501)LA Euro2>				
			Komp.Nr. 505126/01/02	04.97-09.03	TNK	6	<b>0 432 191 589</b>
			Komp.Nr. 505137/01/02				
			Komp.Nr. 505137/07	04.97-09.03	TNK	6	<b>0 432 191 437</b>
			Komp.Nr. 505137/08				
			Komp.Nr. 505137/18	04.97-09.03	TNK	6	<b>0 432 193 459</b>
3240 [SKN]	12,0	290	OM 541.923 <(501)LA Euro2>				
			Komp.Nr. 505126/01/02	04.97-09.03	TNK	6	<b>0 432 191 589</b>
			Komp.Nr. 505137/01/02				
			Komp.Nr. 505137/07	04.97-09.03	TNK	6	<b>0 432 191 437</b>
			Komp.Nr. 505137/08				
			Komp.Nr. 505137/18	04.97-09.03	TNK	6	<b>0 432 193 459</b>
3243 [SKN]	12,0	315	OM 541.925 <(501)LA Euro2>				
			Komp.Nr. 505126/01/02	04.97-09.03	TNK	6	<b>0 432 191 589</b>
			Komp.Nr. 505137/01/02				
			Komp.Nr. 505137/07	04.97-09.03	TNK	6	<b>0 432 191 437</b>
			Komp.Nr. 505137/08				
			Komp.Nr. 505137/18	04.97-09.03	TNK	6	<b>0 432 193 459</b>
3331 [SKN]	12,0	230	OM 541.920 <(501)LA Euro2>				
			Komp.Nr. 505126/01/02	04.97-09.03	TNK	6	<b>0 432 191 589</b>
			Komp.Nr. 505137/01/02				
			Komp.Nr. 505137/07	04.97-09.03	TNK	6	<b>0 432 191 437</b>
			Komp.Nr. 505137/08				
			Komp.Nr. 505137/18	04.97-09.03	TNK	6	<b>0 432 193 459</b>
A [SKN]	12,0	230	OM 541.926 <(501)LA Euro2>				
			Komp.Nr. 505126/01/02	04.97-09.03	TNK	6	<b>0 432 191 589</b>
			Komp.Nr. 505137/01/02				
			Komp.Nr. 505137/07	04.97-09.03	TNK	6	<b>0 432 191 437</b>
			Komp.Nr. 505137/08				
			Komp.Nr. 505137/18	04.97-09.03	TNK	6	<b>0 432 193 459</b>
3335 [SKN]	12,0	260	OM 541.922 <(501)LA Euro2>				
			Komp.Nr. 505126/01/02	04.97-09.03	TNK	6	<b>0 432 191 589</b>
			Komp.Nr. 505137/01/02				
			Komp.Nr. 505137/07	04.97-09.03	TNK	6	<b>0 432 191 437</b>
			Komp.Nr. 505137/08				
			Komp.Nr. 505137/18	04.97-09.03	TNK	6	<b>0 432 193 459</b>
3335 [SKN]	12,0	260	OM 541.922 <(501)LA Euro2>				
			Komp.Nr. 505126/01/02	04.97-09.03	TNK	6	<b>0 432 191 589</b>
			Komp.Nr. 505137/01/02				
			Komp.Nr. 505137/07	04.97-09.03	TNK	6	<b>0 432 191 437</b>
			Komp.Nr. 505137/08				
			Komp.Nr. 505137/18	04.97-09.03	TNK	6	<b>0 432 193 459</b>
3335 [SKN]	12,0	260	OM 541.922 <(501)LA Euro2>				
			Komp.Nr. 505126/01/02	04.97-09.03	TNK	6	<b>0 432 191 589</b>
			Komp.Nr. 505137/01/02				
			Komp.Nr. 505137/07	04.97-09.03	TNK	6	<b>0 432 191 437</b>
			Komp.Nr. 505137/08				
			Komp.Nr. 505137/18	04.97-09.03	TNK	6	<b>0 432 193 459</b>
3335 [SKN]	12,0	260	OM 541.922 <(501)LA Euro2>				
			Komp.Nr. 505126/01/02	04.97-09.03	TNK	6	<b>0 432 191 589</b>
			Komp.Nr. 505137/01/02				
			Komp.Nr. 505137/07	04.97-09.03	TNK	6	<b>0 432 191 437</b>
			Komp.Nr. 505137/08				
			Komp.Nr. 505137/18	04.97-09.03	TNK	6	<b>0 432 193 459</b>
3335 [SKN]	12,0	260	OM 541.922 <(501)LA Euro2>				
			Komp.Nr. 505126/01/02	04.97-09.03	TNK	6	<b>0 432 191 589</b>
			Komp.Nr. 505137/01/02				
			Komp.Nr. 505137/07	04.97-09.03	TNK	6	<b>0 432 191 437</b>
			Komp.Nr. 505137/08				
			Komp.Nr. 505137/18	04.97-09.03	TNK	6	<b>0 432 193 459</b>





◀ MERCEDES-BENZ

<b>3340</b> [SKN]	12,0	290	OM 541.923 <(501)LA Euro2> Komp.Nr. 505126/01/02 Komp.Nr. 505137/01/02	04.97-09.03 TNK	6	<b>0 432 191 589</b>
			Komp.Nr. 505137/07 Komp.Nr. 505137/08	04.97-09.03 TNK	6	<b>0 432 191 437</b>
			Komp.Nr. 505137/18 Komp.Nr. 505137/19	04.97-09.03 TNK	6	<b>0 432 193 459</b>
			Komp.Nr. 505137/31	04.97-09.03 TNK	6	<b>0 432 193 459</b>
A [SKN]	12,0	290	OM 541.924 <(501)LA Euro 2> Komp.Nr. 505126/01/02 Komp.Nr. 505137/01/02	04.97-09.03 TNK	6	<b>0 432 191 589</b>
			Komp.Nr. 505137/07 Komp.Nr. 505137/08	04.97-09.03 TNK	6	<b>0 432 191 437</b>
			Komp.Nr. 505137/18 Komp.Nr. 505137/19	04.97-09.03 TNK	6	<b>0 432 193 459</b>
			Komp.Nr. 505137/31	04.97-09.03 TNK	6	<b>0 432 193 459</b>
<b>3343</b> [SKN]	12,0	315	OM 541.925 <(501)LA Euro2> Komp.Nr. 505126/01/02 Komp.Nr. 505137/01/02	04.97-09.03 TNK	6	<b>0 432 191 589</b>
			Komp.Nr. 505137/07 Komp.Nr. 505137/08	04.97-09.03 TNK	6	<b>0 432 191 437</b>
			Komp.Nr. 505137/18 Komp.Nr. 505137/19	04.97-09.03 TNK	6	<b>0 432 193 459</b>
			Komp.Nr. 505137/31	04.97-09.03 TNK	6	<b>0 432 193 459</b>
A [SKN]	12,0	315	OM 541.921 <(501)LA Euro2> Komp.Nr. 505126/01/02 Komp.Nr. 505137/01/02	04.97-09.03 TNK	6	<b>0 432 191 589</b>
			Komp.Nr. 505137/07 Komp.Nr. 505137/08	04.97-09.03 TNK	6	<b>0 432 191 437</b>
			Komp.Nr. 505137/18 Komp.Nr. 505137/19	04.97-09.03 TNK	6	<b>0 432 193 459</b>
			Komp.Nr. 505137/31	04.97-09.03 TNK	6	<b>0 432 193 459</b>
<b>3348</b> [SKN]	16,0	350	OM 542.921 <(502)LA Euro2> Komp.Nr. 505126/01/02 Komp.Nr. 505137/01/02	04.97-09.03 TNK	8	<b>0 432 191 589</b>
			Komp.Nr. 505137/07 Komp.Nr. 505137/08	04.97-09.03 TNK	8	<b>0 432 191 437</b>
			Komp.Nr. 505137/18 Komp.Nr. 505137/19	04.97-09.03 TNK	8	<b>0 432 193 459</b>
			Komp.Nr. 505137/31	04.97-09.03 TNK	8	<b>0 432 193 459</b>
A [SKN]	16,0	350	OM 542.925 <(502)LA Euro2> Komp.Nr. 505126/01/02 Komp.Nr. 505137/01/02	04.97-09.03 TNK	8	<b>0 432 191 589</b>
			Komp.Nr. 505137/07 Komp.Nr. 505137/08	04.97-09.03 TNK	8	<b>0 432 191 437</b>
			Komp.Nr. 505137/18 Komp.Nr. 505137/19	04.97-09.03 TNK	8	<b>0 432 193 459</b>
			Komp.Nr. 505137/31	04.97-09.03 TNK	8	<b>0 432 193 459</b>







3353 [SKN]	16,0	390	OM 542... <(502)LA>				
			Komp.Nr. 505126/01/02	09.96-09.03	TNK	8	0 432 191 589
			Komp.Nr. 505137/01/02				
			Mot. Typ 542.920				
			Mot. Typ 542.926				
			Mot. Typ 542.943				
			Komp.Nr. 505134/04	09.96-09.03	TNK	8	0 432 191 446
			Mot. Typ 542.943				
			Komp.Nr. 505137 /06	09.96-09.03	TNK	8	0 432 191 459
			Mot. Typ 542.943				
			Komp.Nr. 505137 /28	09.96-09.03	TNK	8	0 432 191 348
			Mot. Typ 542.943				
			Komp.Nr. 505137/07/08	09.96-09.03	TNK	8	0 432 191 437
			Mot. Typ 542.920				
Mot. Typ 542.926							
Komp.Nr. 505137/11	09.96-09.03	TNK	8	0 432 191 384			
Mot. Typ 542.943							
Komp.Nr. 505137/15	09.96-09.03	TNK	8	0 432 191 363			
Mot. Typ 542.943							
Komp.Nr. 505137/18/19	09.96-09.03	TNK	8	0 432 193 459			
Mot. Typ 542.920							
Mot. Typ 542.926							
3357 [SKN]	16,0	420	OM 542.922 <(502)LA Euro2>				
			Komp.Nr. 505126/01/02	04.97-09.03	TNK	8	0 432 191 589
			Komp.Nr. 505137/01/02				
			Komp.Nr. 505137/07	04.97-09.03	TNK	8	0 432 191 437
			Komp.Nr. 505137/08				
			Komp.Nr. 505137/18	04.97-09.03	TNK	8	0 432 193 459
Komp.Nr. 505137/19							
Komp.Nr. 505137/31	04.97-09.03	TNK	8	0 432 193 459			
4140 [SKN]	12,0	290	OM 541.923 <(501)LA Euro2>				
			Komp.Nr. 505126/01/02	04.97-09.03	TNK	6	0 432 191 589
			Komp.Nr. 505137/01/02				
			Komp.Nr. 505137/07	04.97-09.03	TNK	6	0 432 191 437
			Komp.Nr. 505137/08				
			Komp.Nr. 505137/18	04.97-09.03	TNK	6	0 432 193 459
Komp.Nr. 505137/19							
Komp.Nr. 505137/31	04.97-09.03	TNK	6	0 432 193 459			
A [SKN]	12,0	290	OM 541.924 <(501)LA Euro2>				
			Komp.Nr. 505126/01/02	04.97-09.03	TNK	6	0 432 191 589
			Komp.Nr. 505137/01/02				
			Komp.Nr. 505137/07	04.97-09.03	TNK	6	0 432 191 437
			Komp.Nr. 505137/08				
			Komp.Nr. 505137/18	04.97-09.03	TNK	6	0 432 193 459
Komp.Nr. 505137/19							
Komp.Nr. 505137/31	04.97-09.03	TNK	6	0 432 193 459			
4143 [SKN]	12,0	315	OM 541.925 <(501)LA Euro2>				
			Komp.Nr. 505126/01/02	04.97-09.03	TNK	6	0 432 191 589
			Komp.Nr. 505137/01/02				
			Komp.Nr. 505137/07	04.97-09.03	TNK	6	0 432 191 437
			Komp.Nr. 505137/08				
			Komp.Nr. 505137/18	04.97-09.03	TNK	6	0 432 193 459
Komp.Nr. 505137/19							
Komp.Nr. 505137/31	04.97-09.03	TNK	6	0 432 193 459			
A [SKN]	12,0	315	OM 541.921 <(501)LA Euro2>				
			Komp.Nr. 505126/01/02	04.97-09.03	TNK	6	0 432 191 589
			Komp.Nr. 505137/01/02				
			Komp.Nr. 505137/07	04.97-09.03	TNK	6	0 432 191 437
			Komp.Nr. 505137/08				
			Komp.Nr. 505137/18	04.97-09.03	TNK	6	0 432 193 459
Komp.Nr. 505137/19							
Komp.Nr. 505137/31	04.97-09.03	TNK	6	0 432 193 459			





◀ MERCEDES-BENZ

4148 [SKN]	15,9	350	OM 542.925 <(502)LA Euro2>					
			Komp.Nr. 505126/01/02	04.97-09.03	TNK	6	0 432 191 589	
			Komp.Nr. 505137/01/02					
			Komp.Nr. 505137/07	04.97-09.03	TNK	6	0 432 191 437	
			Komp.Nr. 505137/08					
	16,0	350	OM 542.921 <(502)LA Euro2>					
			Komp.Nr. 505126/01/02	04.97-09.03	TNK	8	0 432 191 589	
			Komp.Nr. 505137/01/02					
			Komp.Nr. 505137/07	04.97-09.03	TNK	8	0 432 191 437	
			Komp.Nr. 505137/08					
<b>Actros II</b>								
1832 [MP2]	12,0	235	OM 541.940 <501 LA Euro3>					
			Fg.Nr. 505137 /25	04.03-12.08	TNK	6	0 432 191 347	
			Komp.Nr. 505126 /01/02	04.03-12.08	TNK	6	0 432 191 589	
			Komp.Nr. 505137/ 03	04.03-12.08	TNK	6	0 432 191 446	
			Komp.Nr. 505137/05	04.03-12.08	TNK	6	0 432 191 459	
			Komp.Nr. 505137/10	04.03-12.08	TNK	6	0 432 191 384	
1836 [MP2]	12,0	265	OM 541.942 <501 LA Euro3>					
			Fg.Nr. 505137 /25	04.03-12.08	TNK	6	0 432 191 347	
			Komp.Nr. 505126/ 01	04.03-12.08	TNK	6	0 432 191 589	
			Komp.Nr. 505137/ 03	04.03-12.08	TNK	6	0 432 191 446	
			Komp.Nr. 505137 /03	04.03-12.08	TNK	6	0 432 191 446	
			Komp.Nr. 505137 /05	04.03-12.08	TNK	6	0 432 191 459	
			Komp.Nr. 505137/05	04.03-12.08	TNK	6	0 432 191 459	
			Komp.Nr. 505137/10	04.03-12.08	TNK	6	0 432 191 384	
1841 [MP2]	12,0	300	OM 541.944 <501 LA Euro3>					
			Komp.Nr. 505126/ 01	04.03-12.08	TNK	6	0 432 191 589	
			Komp.Nr. 505137/ 03	04.03-12.08	TNK	6	0 432 191 446	
			Komp.Nr. 505137/03	04.03-12.08	TNK	6	0 432 191 446	
			Komp.Nr. 505137/10	04.03-12.08	TNK	6	0 432 191 384	
			Komp.Nr. 505137/14	04.03-12.08	TNK	6	0 432 191 363	
			Komp.Nr. 505137/27	04.03-12.08	TNK	6	0 432 191 348	
1844 [MP2]	12,0	320	OM 541.946 <501 LA Euro3>					
			Komp.Nr. 505126/01	04.03-12.08	TNK	6	0 432 191 589	
			Komp.Nr. 505137/03	04.03-12.08	TNK	6	0 432 191 446	
			Komp.Nr. 505137/10	04.03-12.08	TNK	6	0 432 191 384	
			Komp.Nr. 505137/14	04.03-12.08	TNK	6	0 432 191 363	
			Komp.Nr. 505137/27	04.03-12.08	TNK	6	0 432 191 348	
1846 [MP2]	12,0	335	OM 541... <501 LA Euro3>					
			Komp.Nr. 505137/14	04.03-12.08	TNK	6	0 432 191 363	
			Komp.Nr. 505137/27	04.03-12.08	TNK	6	0 432 191 348	
			Komp.Nr. 505137/27	04.03-12.08	TNK	6	0 432 191 348	
			Komp.Nr. 505137/31	04.03-12.08	TNK	6	0 432 193 459	
1850 [MP2]	15,9	370	OM 542.940 <502 LA Euro3>					
			Fg.Nr. 505137 /26	04.03-12.08	TNK	8	0 432 191 347	
			Komp.Nr. 505126/ 02	04.03-12.08	TNK	8	0 432 191 589	
			Komp.Nr. 505134/04	04.03-12.08	TNK	8	0 432 191 446	
			Komp.Nr. 505137 /06	04.03-12.08	TNK	8	0 432 191 459	
			Komp.Nr. 505137 /28	04.03-12.08	TNK	8	0 432 191 348	
Komp.Nr. 505137/11	04.03-12.08	TNK	8	0 432 191 384				





<b>1854</b> [MP2]	15,9	395	OM 542.942 <502 LA Euro3>					
			Komp.Nr. 505126/02	04.03-12.08	TNK	8	<b>0 432 191 589</b>	
			Komp.Nr. 505137/04	04.03-12.08	TNK	8	<b>0 432 191 446</b>	
			Komp.Nr. 505137/06	04.03-12.08	TNK	8	<b>0 432 191 459</b>	
			Komp.Nr. 505137/11	04.03-12.08	TNK	8	<b>0 432 191 384</b>	
<b>1858</b> [MP2]	15,9	425	OM 542.944 <502 LA Euro3>					
			Komp.Nr. 505126/02	04.03-12.08	TNK	8	<b>0 432 191 589</b>	
			Komp.Nr. 505137/04	04.03-12.08	TNK	8	<b>0 432 191 446</b>	
			Komp.Nr. 505137/06	04.03-12.08	TNK	8	<b>0 432 191 459</b>	
			Komp.Nr. 505137/28	04.03-12.08		8	<b>0 432 191 348</b>	
<b>1861</b> Black Edition [MP2]	15,9	450	OM 542.958 <502 LA Euro3>					
			Komp.Nr. 505137/28	09.04-12.08		8	<b>0 432 191 348</b>	
<b>2032</b> [MP2]	12,0	235	OM 541.940,941 <501 LA Euro3>					
			Fg.Nr. 505137/25	04.03-12.08	TNK	6	<b>0 432 191 347</b>	
			Komp.Nr. 505126/01/02	04.03-12.08	TNK	6	<b>0 432 191 589</b>	
			Komp.Nr. 505137/03	04.03-12.08	TNK	6	<b>0 432 191 446</b>	
			Komp.Nr. 505137/05	04.03-12.08	TNK	6	<b>0 432 191 459</b>	
			Komp.Nr. 505137/10	04.03-12.08	TNK	6	<b>0 432 191 384</b>	
<b>2036</b> [MP2]	12,0	265	OM 541... <501 LA Euro3>					
			Fg.Nr. 505137/25	04.03-12.08	TNK	6	<b>0 432 191 347</b>	
			Komp.Nr. 505126/01	04.03-12.08	TNK	6	<b>0 432 191 589</b>	
			Komp.Nr. 505137/03	04.03-12.08	TNK	6	<b>0 432 191 446</b>	
			Komp.Nr. 505137/03	04.03-12.08	TNK	6	<b>0 432 191 446</b>	
			Komp.Nr. 505137/05	04.03-12.08	TNK	6	<b>0 432 191 459</b>	
			Komp.Nr. 505137/05	04.03-12.08	TNK	6	<b>0 432 191 459</b>	
			Komp.Nr. 505137/10	04.03-12.08	TNK	6	<b>0 432 191 384</b>	
<b>2041</b> [MP2]	12,0	300	OM 541.944 <501 LA Euro3>					
			Komp.Nr. 505126/01	04.03-12.08	TNK	6	<b>0 432 191 589</b>	
			Komp.Nr. 505137/03	04.03-12.08	TNK	6	<b>0 432 191 446</b>	
			Komp.Nr. 505137/03	04.03-12.08	TNK	6	<b>0 432 191 446</b>	
			Komp.Nr. 505137/28	04.03-12.08	TNK	6	<b>0 432 191 348</b>	
			Mot.Typ 542.943					
			Komp.Nr. 505137/10	04.03-12.08	TNK	6	<b>0 432 191 384</b>	
<b>2044</b> [MP2]	12,0	320	OM 541... <501 LA Euro3>					
			Komp.Nr. 505126/01	04.03-12.08	TNK	6	<b>0 432 191 589</b>	
			Komp.Nr. 505137/03	04.03-12.08	TNK	6	<b>0 432 191 446</b>	
			Komp.Nr. 505137/10	04.03-12.08	TNK	6	<b>0 432 191 384</b>	
			Komp.Nr. 505137/14	04.03-12.08	TNK	6	<b>0 432 191 363</b>	
			Komp.Nr. 505137/27	04.03-12.08	TNK	6	<b>0 432 191 348</b>	
<b>2046</b> [MP2]	12,0	335	OM 541... <501 LA Euro3>					
			Komp.Nr. 505137/14	04.03-12.08	TNK	6	<b>0 432 191 363</b>	
<b>2050</b> [MP2]	15,9	370	OM 542.940 <502 LA Euro3>					
			Fg.Nr. 505137/26	04.03-12.08	TNK	8	<b>0 432 191 347</b>	
			Komp.Nr. 505126/02	04.03-12.08	TNK	8	<b>0 432 191 589</b>	
			Komp.Nr. 505134/04	04.03-12.08	TNK	8	<b>0 432 191 446</b>	
			Komp.Nr. 505137/06	04.03-12.08	TNK	8	<b>0 432 191 459</b>	
			Komp.Nr. 505137/28	04.03-12.08		8	<b>0 432 191 348</b>	
			Komp.Nr. 505137/11	04.03-12.08	TNK	8	<b>0 432 191 384</b>	





◀ MERCEDES-BENZ

<b>2054</b> [MP2]	15,9	395	OM 542.942 <502 LA Euro3>					
			Komp.Nr. 505126/02	04.03-12.08	TNK	8	<b>0 432 191 589</b>	
			Komp.Nr. 505137/04	04.03-12.08	TNK	8	<b>0 432 191 446</b>	
			Komp.Nr. 505137/06	04.03-12.08	TNK	8	<b>0 432 191 459</b>	
			Komp.Nr. 505137/11	04.03-12.08	TNK	8	<b>0 432 191 384</b>	
			Komp.Nr. 505137/15	04.03-12.08	TNK	8	<b>0 432 191 363</b>	
<b>2532</b> [MP2]	12,0	235	OM 541.940 <501 LA Euro3>					
			Fg.Nr. 505137/25	04.03-12.08	TNK	6	<b>0 432 191 347</b>	
			Komp.Nr. 505126/01/02	04.03-12.08	TNK	6	<b>0 432 191 589</b>	
			Komp.Nr. 505137/03	04.03-12.08	TNK	6	<b>0 432 191 446</b>	
			Komp.Nr. 505137/05	04.03-12.08	TNK	6	<b>0 432 191 459</b>	
			Komp.Nr. 505137/10	04.03-12.08	TNK	6	<b>0 432 191 384</b>	
			Komp.Nr. 505137/31	04.03-12.08	TNK	6	<b>0 432 193 459</b>	
<b>2536</b> [MP2]	12,0	265	OM 541.942 <501 LA Euro3>					
			Fg.Nr. 505137/25	04.03-12.08	TNK	6	<b>0 432 191 347</b>	
			Komp.Nr. 505126/01	04.03-12.08	TNK	6	<b>0 432 191 589</b>	
			Komp.Nr. 505137/03	04.03-12.08	TNK	6	<b>0 432 191 446</b>	
			Komp.Nr. 505137/03	04.03-12.08	TNK	6	<b>0 432 191 446</b>	
			Komp.Nr. 505137/05	04.03-12.08	TNK	6	<b>0 432 191 459</b>	
			Komp.Nr. 505137/05	04.03-12.08	TNK	6	<b>0 432 191 459</b>	
			Komp.Nr. 505137/10	04.03-12.08	TNK	6	<b>0 432 191 384</b>	
			Komp.Nr. 505137/14	04.03-12.08	TNK	6	<b>0 432 191 363</b>	
			Komp.Nr. 505137/31	04.03-12.08	TNK	6	<b>0 432 193 459</b>	
<b>2541</b> [MP2]	12,0	300	OM 541.944 <501 LA Euro3>					
			Komp.Nr. 505126/01	04.03-12.08	TNK	6	<b>0 432 191 589</b>	
			Komp.Nr. 505137/03	04.03-12.08	TNK	6	<b>0 432 191 446</b>	
			Komp.Nr. 505137/03	04.03-12.08	TNK	6	<b>0 432 191 446</b>	
			Komp.Nr. 505137/10	04.03-12.08	TNK	6	<b>0 432 191 384</b>	
			Komp.Nr. 505137/14	04.03-12.08	TNK	6	<b>0 432 191 363</b>	
			Komp.Nr. 505137/27	04.03-12.08	TNK	6	<b>0 432 191 348</b>	
			Komp.Nr. 505137/31	04.03-12.08	TNK	6	<b>0 432 193 459</b>	
<b>2544</b> [MP2]	12,0	320	OM 541.946 <501 LA Euro3>					
			Komp.Nr. 505126/01	04.03-12.08	TNK	6	<b>0 432 191 589</b>	
			Komp.Nr. 505137/03	04.03-12.08	TNK	6	<b>0 432 191 446</b>	
			Komp.Nr. 505137/10	04.03-12.08	TNK	6	<b>0 432 191 384</b>	
			Komp.Nr. 505137/14	04.03-12.08	TNK	6	<b>0 432 191 363</b>	
			Komp.Nr. 505137/27	04.03-12.08	TNK	6	<b>0 432 191 348</b>	
			Komp.Nr. 505137/31	04.03-12.08	TNK	6	<b>0 432 193 459</b>	
<b>2546</b> [MP2]	12,0	335	OM 541.948 <501 LA Euro3>					
			Komp.Nr. 505137/14	04.03-12.08	TNK	6	<b>0 432 191 363</b>	
			Komp.Nr. 505137/27	04.03-12.08	TNK	6	<b>0 432 191 348</b>	
<b>2550</b> [MP2]	15,9	370	OM 542.940 <502 LA Euro3>					
			Fg.Nr. 505137/26	04.03-12.08	TNK	8	<b>0 432 191 347</b>	
			Komp.Nr. 505126/02	04.03-12.08	TNK	8	<b>0 432 191 589</b>	
			Komp.Nr. 505134/04	04.03-12.08	TNK	8	<b>0 432 191 446</b>	
			Komp.Nr. 505137/06	04.03-12.08	TNK	8	<b>0 432 191 459</b>	
			Komp.Nr. 505137/28	04.03-12.08	TNK	8	<b>0 432 191 348</b>	
			Komp.Nr. 505137/11	04.03-12.08	TNK	8	<b>0 432 191 384</b>	
<b>2554</b> [MP2]	15,9	395	OM 542.942 <502 LA Euro3>					
			Komp.Nr. 505126/02	04.03-12.08	TNK	8	<b>0 432 191 589</b>	
			Komp.Nr. 505137/04	04.03-12.08	TNK	8	<b>0 432 191 446</b>	
			Komp.Nr. 505137/06	04.03-12.08	TNK	8	<b>0 432 191 459</b>	
			Komp.Nr. 505137/11	04.03-12.08	TNK	8	<b>0 432 191 384</b>	
			Komp.Nr. 505137/15	04.03-12.08	TNK	8	<b>0 432 191 363</b>	
<b>2558</b> [MP2]	15,9	425	OM 542.944 <502 LA Euro3>					
			Komp.Nr. 505126/02	04.03-12.08	TNK	8	<b>0 432 191 589</b>	
			Komp.Nr. 505137/04	04.03-12.08	TNK	8	<b>0 432 191 446</b>	
			Komp.Nr. 505137/06	04.03-12.08	TNK	8	<b>0 432 191 459</b>	
			Komp.Nr. 505137/28	04.03-12.08	TNK	8	<b>0 432 191 348</b>	
			Komp.Nr. 505137/11	04.03-12.08	TNK	8	<b>0 432 191 384</b>	
			Komp.Nr. 505137/15	04.03-12.08	TNK	8	<b>0 432 191 363</b>	





2632 [MP2]	12,0	235	OM 541.940 <501 LA Euro3>								
			Fg.Nr. 505137 /25	04.03-12.08	TNK	6	<b>0 432 191 347</b>				
			Komp.Nr. 505126 /01/02	04.03-12.08	TNK	6	<b>0 432 191 589</b>				
			Komp.Nr. 505137 /03	04.03-12.08	TNK	6	<b>0 432 191 446</b>				
			Komp.Nr. 505137 /05	04.03-12.08	TNK	6	<b>0 432 191 459</b>				
			Komp.Nr. 505137 /10	04.03-12.08	TNK	6	<b>0 432 191 384</b>				
2636 [MP2]	12,0	265	OM 541.942 <501 LA Euro3>								
			Fg.Nr. 505137 /25	04.03-12.08	TNK	6	<b>0 432 191 347</b>				
			Komp.Nr. 505126 /01	04.03-12.08	TNK	6	<b>0 432 191 589</b>				
			Komp.Nr. 505137 /03	04.03-12.08	TNK	6	<b>0 432 191 446</b>				
			Komp.Nr. 505137 /03	04.03-12.08	TNK	6	<b>0 432 191 446</b>				
			Komp.Nr. 505137 /05	04.03-12.08	TNK	6	<b>0 432 191 459</b>				
2641 [MP2]	12,0	300	OM 541.944 <501 LA Euro3>								
			Komp.Nr. 505126 /01	06.03-12.08	TNK	6	<b>0 432 191 589</b>				
			Komp.Nr. 505137 /03	06.03-12.08	TNK	6	<b>0 432 191 446</b>				
			Komp.Nr. 505137 /03	06.03-12.08	TNK	6	<b>0 432 191 446</b>				
			Komp.Nr. 505137 /10	06.03-12.08	TNK	6	<b>0 432 191 384</b>				
			Komp.Nr. 505137 /14	06.03-12.08	TNK	6	<b>0 432 191 363</b>				
2644 [MP2]	12,0	320	OM 541.946 <501 LA Euro3>								
			Komp.Nr. 505126 /01	06.03-12.08	TNK	6	<b>0 432 191 589</b>				
			Komp.Nr. 505137 /03	06.03-12.08	TNK	6	<b>0 432 191 446</b>				
			Komp.Nr. 505137 /10	06.03-12.08	TNK	6	<b>0 432 191 384</b>				
			Komp.Nr. 505137 /14	06.03-12.08	TNK	6	<b>0 432 191 363</b>				
			Komp.Nr. 505137 /27	06.03-12.08	TNK	6	<b>0 432 191 348</b>				
2646 [MP2]	12,0	335	OM 541.948 <501 LA Euro3>								
			Komp.Nr. 505137 /14	06.03-12.08	TNK	6	<b>0 432 191 363</b>				
			Komp.Nr. 505137 /27	06.03-12.08	TNK	6	<b>0 432 191 348</b>				
			Komp.Nr. 505137 /31	06.03-12.08	TNK	6	<b>0 432 193 459</b>				
			2650 [MP2]	15,9	370	OM 542.940 <502 LA Euro3>					
						Fg.Nr. 505137 /26	04.03-12.08	TNK	8	<b>0 432 191 347</b>	
Komp.Nr. 505126 /02	04.03-12.08	TNK				8	<b>0 432 191 589</b>				
Komp.Nr. 505134 /04	04.03-12.08	TNK				8	<b>0 432 191 446</b>				
Komp.Nr. 505137 /06	04.03-12.08	TNK				8	<b>0 432 191 459</b>				
Komp.Nr. 505137 /28	04.03-12.08					8	<b>0 432 191 348</b>				
2654 [MP2]	15,9	395	OM 542.942 <502 LA Euro3>								
			Komp.Nr. 505126 /02	04.03-12.08	TNK	8	<b>0 432 191 589</b>				
			Komp.Nr. 505137 /04	04.03-12.08	TNK	8	<b>0 432 191 446</b>				
			Komp.Nr. 505137 /06	04.03-12.08	TNK	8	<b>0 432 191 459</b>				
			Komp.Nr. 505137 /11	04.03-12.08	TNK	8	<b>0 432 191 384</b>				
			Komp.Nr. 505137 /15	04.03-12.08	TNK	8	<b>0 432 191 363</b>				
2658 [MP2]	15,9	425	OM 542.944 <502 LA Euro3>								
			Komp.Nr. 505126 /02	04.03-12.08	TNK	8	<b>0 432 191 589</b>				
			Komp.Nr. 505137 /04	04.03-12.08	TNK	8	<b>0 432 191 446</b>				
			Komp.Nr. 505137 /06	04.03-12.08	TNK	8	<b>0 432 191 459</b>				
			Komp.Nr. 505137 /28	04.03-12.08		8	<b>0 432 191 348</b>				
			Komp.Nr. 505137 /11	04.03-12.08	TNK	8	<b>0 432 191 384</b>				
3232 [MP2]	12,0	235	OM 541.940 <501 LA Euro3>								
			Fg.Nr. 505137 /25	04.03-12.08	TNK	6	<b>0 432 191 347</b>				
			Komp.Nr. 505126 /01/02	04.03-12.08	TNK	6	<b>0 432 191 589</b>				
			Komp.Nr. 505137 /03	04.03-12.08	TNK	6	<b>0 432 191 446</b>				
			Komp.Nr. 505137 /05	04.03-12.08	TNK	6	<b>0 432 191 459</b>				
			Komp.Nr. 505137 /10	04.03-12.08	TNK	6	<b>0 432 191 384</b>				
3232 [MP2]	12,0	235	OM 541.940 <501 LA Euro3>								
			Fg.Nr. 505137 /25	04.03-12.08	TNK	6	<b>0 432 191 347</b>				
			Komp.Nr. 505126 /01/02	04.03-12.08	TNK	6	<b>0 432 191 589</b>				
			Komp.Nr. 505137 /03	04.03-12.08	TNK	6	<b>0 432 191 446</b>				
			Komp.Nr. 505137 /05	04.03-12.08	TNK	6	<b>0 432 191 459</b>				
			Komp.Nr. 505137 /10	04.03-12.08	TNK	6	<b>0 432 191 384</b>				





◀ MERCEDES-BENZ

<b>3232</b> [MP2]	12,0	265	OM 541.942 <501 LA Euro3>					
			Fg.Nr. 505137 /25	04.03-12.08	TNK	6	<b>0 432 191 347</b>	
			Komp.Nr. 505126/ 01	04.03-12.08	TNK	6	<b>0 432 191 589</b>	
			Komp.Nr. 505137/ 03	04.03-12.08	TNK	6	<b>0 432 191 446</b>	
			Komp.Nr. 505137 /03	04.03-12.08	TNK	6	<b>0 432 191 446</b>	
			Komp.Nr. 505137 /05	04.03-12.08	TNK	6	<b>0 432 191 459</b>	
			Komp.Nr. 505137/05	04.03-12.08	TNK	6	<b>0 432 191 459</b>	
			Komp.Nr. 505137/10	04.03-12.08	TNK	6	<b>0 432 191 384</b>	
			Komp.Nr. 505137/14	04.03-12.08	TNK	6	<b>0 432 191 363</b>	
Komp.Nr. 505137/31	04.03-12.08	TNK	6	<b>0 432 193 459</b>				
<b>3241</b> [MP2]	12,0	300	OM 541.944 <501 LA Euro3>					
			Komp.Nr. 505126/ 01	04.03-12.08	TNK	6	<b>0 432 191 589</b>	
			Komp.Nr. 505137/ 03	04.03-12.08	TNK	6	<b>0 432 191 446</b>	
			Komp.Nr. 505137 /03	04.03-12.08	TNK	6	<b>0 432 191 446</b>	
			Komp.Nr. 505137/10	04.03-12.08	TNK	6	<b>0 432 191 384</b>	
			Komp.Nr. 505137/14	04.03-12.08	TNK	6	<b>0 432 191 363</b>	
			Komp.Nr. 505137/27	04.03-12.08	TNK	6	<b>0 432 191 348</b>	
Komp.Nr. 505137/31	04.03-12.08	TNK	6	<b>0 432 193 459</b>				
<b>3246</b> [MP2]	12,0	335	OM 541.948 <501 LA Euro3>					
			Komp.Nr. 505137/14	04.03-12.08	TNK	6	<b>0 432 191 363</b>	
			Komp.Nr. 505137/27	04.03-12.08	TNK	6	<b>0 432 191 348</b>	
<b>3332</b> [MP2]	12,0	235	OM 541.940 <501 LA Euro3>					
			Fg.Nr. 505137 /25	04.03-12.08	TNK	6	<b>0 432 191 347</b>	
			Komp.Nr. 505126 /01/02	04.03-12.08	TNK	6	<b>0 432 191 589</b>	
			Komp.Nr. 505137/ 03	04.03-12.08	TNK	6	<b>0 432 191 446</b>	
			Komp.Nr. 505137 /05	04.03-12.08	TNK	6	<b>0 432 191 459</b>	
			Komp.Nr. 505137/10	04.03-12.08	TNK	6	<b>0 432 191 384</b>	
Komp.Nr. 505137/31	04.03-12.08	TNK	6	<b>0 432 193 459</b>				
<b>3336</b> [MP2]	12,0	265	OM 541.942 <501 LA Euro3>					
			Fg.Nr. 505137 /25	04.03-12.08	TNK	6	<b>0 432 191 347</b>	
			Komp.Nr. 505126/ 01	04.03-12.08	TNK	6	<b>0 432 191 589</b>	
			Komp.Nr. 505137/ 03	04.03-12.08	TNK	6	<b>0 432 191 446</b>	
			Komp.Nr. 505137 /03	04.03-12.08	TNK	6	<b>0 432 191 446</b>	
			Komp.Nr. 505137 /05	04.03-12.08	TNK	6	<b>0 432 191 459</b>	
			Komp.Nr. 505137/05	04.03-12.08	TNK	6	<b>0 432 191 459</b>	
			Komp.Nr. 505137/10	04.03-12.08	TNK	6	<b>0 432 191 384</b>	
			Komp.Nr. 505137/14	04.03-12.08	TNK	6	<b>0 432 191 363</b>	
Komp.Nr. 505137/31	04.03-12.08	TNK	6	<b>0 432 193 459</b>				
<b>3341</b> [MP2]	12,0	300	OM 541.944 <501 LA Euro3>					
			Komp.Nr. 505126/ 01	04.03-12.08	TNK	6	<b>0 432 191 589</b>	
			Komp.Nr. 505137/ 03	04.03-12.08	TNK	6	<b>0 432 191 446</b>	
			Komp.Nr. 505137 /03	04.03-12.08	TNK	6	<b>0 432 191 446</b>	
			Komp.Nr. 505137/10	04.03-12.08	TNK	6	<b>0 432 191 384</b>	
			Komp.Nr. 505137/14	04.03-12.08	TNK	6	<b>0 432 191 363</b>	
			Komp.Nr. 505137/27	04.03-12.08	TNK	6	<b>0 432 191 348</b>	
			Komp.Nr. 505137/31	04.03-12.08	TNK	6	<b>0 432 193 459</b>	
<b>3344</b> [MP2]	12,0	320	OM 541.946 <501 LA Euro3>					
			Komp.Nr. 505126/ 01	06.03-12.08	TNK	6	<b>0 432 191 589</b>	
			Komp.Nr. 505137/ 03	06.03-12.08	TNK	6	<b>0 432 191 446</b>	
			Komp.Nr. 505137/10	06.03-12.08	TNK	6	<b>0 432 191 384</b>	
			Komp.Nr. 505137/14	06.03-12.08	TNK	6	<b>0 432 191 363</b>	
			Komp.Nr. 505137/27	06.03-12.08	TNK	6	<b>0 432 191 348</b>	
Komp.Nr. 505137/31	06.03-12.08	TNK	6	<b>0 432 193 459</b>				
<b>3346</b> [MP2]	12,0	335	OM 541... <501 LA Euro3>					
			Komp.Nr. 505137/14	06.03-12.08	TNK	6	<b>0 432 191 363</b>	
Komp.Nr. 505137/27	06.03-12.08	TNK	6	<b>0 432 191 348</b>				
<b>3350</b> [MP2]	15,9	370	OM 542.940 <502 LA Euro3>					
			Fg.Nr. 505137 /26	04.03-12.08	TNK	8	<b>0 432 191 347</b>	
			Komp.Nr. 505126/ 02	04.03-12.08	TNK	8	<b>0 432 191 589</b>	
			Komp.Nr. 505134/04	04.03-12.08	TNK	8	<b>0 432 191 446</b>	
			Komp.Nr. 505137 /06	04.03-12.08	TNK	8	<b>0 432 191 459</b>	
			Komp.Nr. 505137 /28	04.03-12.08	TNK	8	<b>0 432 191 348</b>	
Komp.Nr. 505137/11	04.03-12.08	TNK	8	<b>0 432 191 384</b>				





<b>3350</b> [MP2]	15,9	370	OM 542.941 <502 LA Euro3>					
			Fg.Nr. 505137 /26	04.03-12.08	TNK	8	<b>0 432 191 347</b>	
			Komp.Nr. 505126/ 02	04.03-12.08	TNK	8	<b>0 432 191 589</b>	
			Komp.Nr. 505137/ 04	04.03-12.08	TNK	8	<b>0 432 191 446</b>	
			Komp.Nr. 505137 /06	04.03-12.08	TNK	8	<b>0 432 191 459</b>	
			Komp.Nr. 505137 /28	04.03-12.08		8	<b>0 432 191 348</b>	
			Komp.Nr. 505137/11	04.03-12.08	TNK	8	<b>0 432 191 384</b>	
<b>3354</b> [MP2]	15,9	395	OM 542.942 <502 LA Euro3>					
			Komp.Nr. 505126/ 02	04.03-12.08	TNK	8	<b>0 432 191 589</b>	
			Komp.Nr. 505137/ 04	04.03-12.08	TNK	8	<b>0 432 191 446</b>	
			Komp.Nr. 505137 /06	04.03-12.08	TNK	8	<b>0 432 191 459</b>	
			Komp.Nr. 505137/11	04.03-12.08	TNK	8	<b>0 432 191 384</b>	
			Komp.Nr. 505137/15	04.03-12.08	TNK	8	<b>0 432 191 363</b>	
<b>3358</b> [MP2]	15,9	425	OM 542.944 <502 LA Euro3>					
			Komp.Nr. 505126/ 02	04.03-12.08	TNK	8	<b>0 432 191 589</b>	
			Komp.Nr. 505137/ 04	04.03-12.08	TNK	8	<b>0 432 191 446</b>	
			Komp.Nr. 505137 /06	04.03-12.08	TNK	8	<b>0 432 191 459</b>	
			Komp.Nr. 505137 /28	04.03-12.08		8	<b>0 432 191 348</b>	
			Komp.Nr. 505137/11	04.03-12.08	TNK	8	<b>0 432 191 384</b>	
			Komp.Nr. 505137/15	04.03-12.08	TNK	8	<b>0 432 191 363</b>	
<b>4141</b> [MP2]	12,0	300	OM 541.944 <501 LA Euro3>					
			Komp.Nr. 505126/ 01	04.03-12.08	TNK	6	<b>0 432 191 589</b>	
			Komp.Nr. 505137/ 03	04.03-12.08	TNK	6	<b>0 432 191 446</b>	
			Komp.Nr. 505137 /03	04.03-12.08	TNK	6	<b>0 432 191 446</b>	
			Komp.Nr. 505137/10	04.03-12.08	TNK	6	<b>0 432 191 384</b>	
			Komp.Nr. 505137/14	04.03-12.08	TNK	6	<b>0 432 191 363</b>	
			Komp.Nr. 505137/27	04.03-12.08	TNK	6	<b>0 432 191 348</b>	
			Komp.Nr. 505137/31	04.03-12.08	TNK	6	<b>0 432 193 459</b>	
<b>4144</b> [MP2]	12,0	320	OM 541.946 <501 LA Euro3>					
			Komp.Nr. 505126/ 01	06.03-12.08	TNK	6	<b>0 432 191 589</b>	
			Komp.Nr. 505137/ 03	06.03-12.08	TNK	6	<b>0 432 191 446</b>	
			Komp.Nr. 505137/10	06.03-12.08	TNK	6	<b>0 432 191 384</b>	
			Komp.Nr. 505137/14	06.03-12.08	TNK	6	<b>0 432 191 363</b>	
			Komp.Nr. 505137/27	06.03-12.08	TNK	6	<b>0 432 191 348</b>	
			Komp.Nr. 505137/31	06.03-12.08	TNK	6	<b>0 432 193 459</b>	
<b>4146</b> [MP2]	12,0	335	OM 541... <501 LA Euro3>					
			Komp.Nr. 505137/14	04.03-12.08	TNK	6	<b>0 432 191 363</b>	
			Komp.Nr. 505137/27	04.03-12.08	TNK	6	<b>0 432 191 348</b>	
<b>4150</b> [MP2]	15,9	370	OM 542.940 <502 LA Euro3>					
			Fg.Nr. 505137 /26	04.03-12.08	TNK	8	<b>0 432 191 347</b>	
			Komp.Nr. 505126/ 02	04.03-12.08	TNK	8	<b>0 432 191 589</b>	
			Komp.Nr. 505134/04	04.03-12.08	TNK	8	<b>0 432 191 446</b>	
			Komp.Nr. 505137 /06	04.03-12.08	TNK	8	<b>0 432 191 459</b>	
			Komp.Nr. 505137 /28	04.03-12.08		8	<b>0 432 191 348</b>	
			Komp.Nr. 505137/11	04.03-12.08	TNK	8	<b>0 432 191 384</b>	
<b>Atego</b>								
<b>712</b> [LKN]	4,3	90	OM 904.909 LA <Euro2>					
			Mot.Nr. ->..022247	01.98-09.04		4	<b>0 432 193 480</b>	
			Mot.Nr. ..022248->	01.98-09.04		4	<b>0 432 191 526</b>	
			OM 904.915 LA <Euro 3>					
			Komp.Nr. 505047/20	09.00-09.04	TNK	4	<b>0 432 191 394</b>	
			Mot.Nr. ->..022247	09.00-09.04	TNK	4	<b>0 432 193 480</b>	
			Komp.Nr. 505047 05/09/10					
			Mot.Nr. ..022248->	09.00-09.04	TNK	4	<b>0 432 191 526</b>	
			Komp.Nr. 505047 /09/11					
<b>714</b> [LKN]	4,3	100	OM 904.916 LA <Euro 3>					
			Komp.Nr. 505047/05	09.00-09.04	TNK	4	<b>0 432 193 480</b>	
			Komp.Nr. 505047/09					
			Komp.Nr. 505047/10					
			Komp.Nr. 505047/09	09.00-09.04	TNK	4	<b>0 432 191 526</b>	
			Komp.Nr. 505047/11					
			Komp.Nr. 505047/20	09.00-09.04	TNK	4	<b>0 432 191 394</b>	





◀ MERCEDES-BENZ

<b>714</b> , L [LKN]	4,3	100	OM 904.910 LA <Euro2> Mot.Nr. →..022247 Mot.Nr. ...022248→	01.98-09.04 01.98-09.04	4 4	<b>0 432 193 480</b> <b>0 432 191 526</b>
<b>715</b> [LKN]	4,3	110	OM 904.950 LA <Euro 3> Mot.Nr. →..022247 Komp.Nr. 505047 05/09/10 Mot.Nr. ...022248→ Komp.Nr. 505047 /09/11	09.00-09.04 09.00-09.04 TNK 09.00-09.04 TNK	4 4 4	<b>0 432 191 394</b> <b>0 432 193 480</b> <b>0 432 191 526</b>
, L [LKN]	4,3	112	OM 904.922 LA <Euro2> Mot.Nr. →..022247 Mot.Nr. ...022248→	01.98-09.04 01.98-09.04	4 4	<b>0 432 193 480</b> <b>0 432 191 526</b>
<b>717</b> [LKN]	4,3	125	OM 904.917 LA <Euro 3> Komp.Nr. 505047/20 Mot.Nr. →..022247 Komp.Nr. 505047 05/09/10 Mot.Nr. ...022248→ Komp.Nr. 505047 /09/11	09.00-09.04 TNK 09.00-09.04 TNK 09.00-09.04 TNK	4 4 4	<b>0 432 191 394</b> <b>0 432 193 480</b> <b>0 432 191 526</b>
, L [LKN]	4,3	125	OM 904.911 LA <Euro2> Mot.Nr. →..022247 Mot.Nr. ...022248→	01.98-09.04 01.98-09.04	4 4	<b>0 432 193 480</b> <b>0 432 191 526</b>
<b>812</b> [LKN]	4,3	90	OM 904.909 LA <Euro 3> Mot.Nr. →..022247 Mot.Nr. ...022248→	01.98-10.04 01.98-10.04	4 4	<b>0 432 193 480</b> <b>0 432 191 526</b>
<b>814</b> [LKN]	4,3	100	OM 904.916 LA <Euro3> Komp.Nr. 505047/05 Komp.Nr. 505047/09 Komp.Nr. 505047/10 Komp.Nr. 505047/09 Komp.Nr. 505047/11 Komp.Nr. 505047/20	09.00-09.04 TNK 09.00-09.04 TNK 09.00-09.04 TNK	4 4 4 4	<b>0 432 193 480</b> <b>0 432 191 526</b> <b>0 432 191 394</b>
, L [LKN]	4,3	100	OM 904.910 LA <Euro2> Mot.Nr. →..022247 Mot.Nr. ...022248→	01.98-09.04 01.98-09.04	4 4	<b>0 432 193 480</b> <b>0 432 191 526</b>
<b>815</b> [LKN]	4,3	110	OM 904.950 LA <Euro 3> Mot.Nr. →..022247 Komp.Nr. 505047 05/09/10 Mot.Nr. ...022248→ Komp.Nr. 505047 /09/11	09.00-09.04 09.00-09.04 TNK 09.00-09.04 TNK	4 4 4	<b>0 432 191 394</b> <b>0 432 193 480</b> <b>0 432 191 526</b>
, F, L [LKN]	4,3	112	OM 904.922 LA <Euro2> Mot.Nr. →..022247 Mot.Nr. ...022248→	01.98-09.04 01.98-09.04	4 4	<b>0 432 193 480</b> <b>0 432 191 526</b>
<b>817</b> , L [LKN]	4,3	125	OM 904.911 LA <Euro2> Mot.Nr. →..022247 Mot.Nr. ...022248→	01.98-09.04 01.98-09.04	4 4	<b>0 432 193 480</b> <b>0 432 191 526</b>
F [LKN]	4,3	112	OM 904.922 LA <Euro2> Mot.Nr. →..022247 Mot.Nr. ...022248→	01.98-09.04 01.98-09.04	4 4	<b>0 432 193 480</b> <b>0 432 191 526</b>
<b>818</b> [LKN]	4,3	130	OM 904.951 LA <Euro 3>	09.00-09.04	4	<b>0 432 193 438</b>
<b>823</b> [LKN]	6,4	170	OM 906.925 LA <Euro 3> Komp.Nr. 505047/21 Komp.Nr. 505074 /12/15 Mot.Nr. →..022247 Mot.Nr. ...022248→..056812 Mot.Nr. ...056813→	09.00-09.04 TNK 09.00-09.04 TNK 09.00-09.04 09.00-09.04 09.00-09.04	6 6 6 6 6	<b>0 432 191 301</b> <b>0 432 193 481</b> <b>0 432 193 480</b> <b>0 432 191 526</b> <b>0 432 191 278</b>
, L [LKN]	6,4	170	OM 906.910 LA <Euro2> Komp.Nr. 505074 /12/15 Mot.Nr. →..022247 Mot.Nr. ...022248→..056812 Mot.Nr. ...056813→	01.98-09.04 TNK 01.98-09.04 01.98-09.04 01.98-09.04	6 6 6 6	<b>0 432 193 481</b> <b>0 432 193 480</b> <b>0 432 191 526</b> <b>0 432 191 278</b>







<b>915</b> [LKN]	4,3	110	OM 904.950 LA <Euro 3>	09.00-09.04	4	<b>0 432 191 394</b>
			Mot.Nr. →..022247	09.00-09.04 TNK	4	<b>0 432 193 480</b>
			Komp.Nr. 505047 05/09/10			
			Mot.Nr. ..022248→	09.00-09.04 TNK	4	<b>0 432 191 526</b>
			Komp.Nr. 505047/09/11			
AF [LKN]	4,3	125	OM 904.911 LA <Euro2>			
			Mot.Nr. →..022247	01.98-09.04	4	<b>0 432 193 480</b>
			Mot.Nr. ..022248→	01.98-09.04	4	<b>0 432 191 526</b>
<b>917</b> [LKN]	4,3	125-128	OM 904... <Euro3>	01.98-09.04 TW	4	<b>0 432 191 526</b>
					4	<b>0 432 193 438</b>
					4	<b>0 432 193 480</b>
, KO, L [LKN]	4,3	125	OM 904.911 LA <Euro2>			
			Mot.Nr. →..022247	01.98-09.04	4	<b>0 432 193 480</b>
			Mot.Nr. ..022248→	01.98-09.04	4	<b>0 432 191 526</b>
<b>918</b> [LKN]	4,3	130	OM 904.951 LA <Euro3>	09.00-09.04	4	<b>0 432 193 438</b>
<b>923</b> [LKN]	6,4	170	OM 906.925 LA <Euro 3>			
			Komp.Nr. 505047/21	09.00-09.04 TNK	6	<b>0 432 191 301</b>
			Komp.Nr. 505074/12/15	09.00-09.04 TNK	6	<b>0 432 193 481</b>
			Mot.Nr. →..022247	09.00-09.04	6	<b>0 432 193 480</b>
			Mot.Nr. ..022248→..056812	09.00-09.04	6	<b>0 432 191 526</b>
			Mot.Nr. ..056813→	09.00-09.04	6	<b>0 432 191 278</b>
, L [LKN]	6,4	170	OM 906.910 LA <Euro2>			
			Komp.Nr. 505074/12/15	01.98-09.04 TNK	6	<b>0 432 193 481</b>
			Mot.Nr. →..022247	01.98-09.04	6	<b>0 432 193 480</b>
			Mot.Nr. ..022248→..056812	01.98-09.04	6	<b>0 432 191 526</b>
			Mot.Nr. ..056813→	01.98-09.04	6	<b>0 432 191 278</b>
<b>925</b> AF [LKN]	6,4	180	OM 906... <Euro 2/3>			
			Komp.Nr. 505074/12/15	01.98-09.04 TNK	6	<b>0 432 193 481</b>
			Mot.Typ 906.919			
			Mot.Nr. →..022247	01.98-09.04	6	<b>0 432 193 480</b>
			Mot.Typ 906.919			
			Mot.Nr. ..022248→..056812	01.98-09.04	6	<b>0 432 191 526</b>
			Mot.Typ 906.919			
			Mot.Nr. ..056813→	01.98-09.04	6	<b>0 432 191 278</b>
			Mot.Typ 906.919			
			Mot.Typ 906.939	01.98-09.04	6	<b>0 432 191 301</b>
<b>1015</b> [LKN]	4,3	110	OM 904.950 LA <Euro 3>	09.00-09.04	4	<b>0 432 191 394</b>
			Mot.Nr. →..022247	09.00-09.04 TNK	4	<b>0 432 193 480</b>
			Komp.Nr. 505047 05/09/10			
			Mot.Nr. ..022248→	09.00-09.04 TNK	4	<b>0 432 191 526</b>
			Komp.Nr. 505047/09/11			
<b>1017</b> , A, AK, KO, L [LKN]	4,3	125	OM 904.911 LA <Euro2>			
			Mot.Nr. →..022247	01.98-09.04	4	<b>0 432 193 480</b>
			Mot.Nr. ..022248→	01.98-09.04	4	<b>0 432 191 526</b>
<b>1018</b> [LKN]	4,3	130	OM 904.951 LA <Euro 3>	09.00-09.04	4	<b>0 432 193 438</b>
<b>1023</b> [LKN]	6,4	170	OM 906.925 LA <Euro3>			
			Komp.Nr. 505047/21	09.00-09.04 TNK	6	<b>0 432 191 301</b>
			Komp.Nr. 505074/12/15	09.00-09.04 TNK	6	<b>0 432 193 481</b>
			Mot.Nr. →..022247	09.00-09.04	6	<b>0 432 193 480</b>
			Mot.Nr. ..022248→..056812	09.00-09.04	6	<b>0 432 191 526</b>
			Mot.Nr. ..056813→	09.00-09.04	6	<b>0 432 191 278</b>
, L [LKN]	6,4	170	OM 906.910 LA <Euro2>			
			Komp.Nr. 505074/12/15	01.98-09.04 TNK	6	<b>0 432 193 481</b>
			Mot.Nr. →..022247	01.98-09.04	6	<b>0 432 193 480</b>
			Mot.Nr. ..022248→..056812	01.98-09.04	6	<b>0 432 191 526</b>
			Mot.Nr. ..056813→	01.98-09.04	6	<b>0 432 191 278</b>
<b>1214</b> , L [LKN]	4,3	100	OM 904.910 LA <Euro2>			
			Mot.Nr. →..022247	01.98-09.04	4	<b>0 432 193 480</b>
			Mot.Nr. ..022248→	01.98-09.04	4	<b>0 432 191 526</b>





◀ MERCEDES-BENZ

<b>1215</b> [LKN]	4,3	110	OM 904.950 LA <Euro 3>	09.00-09.04		4	<b>0 432 191 394</b>
			Mot.Nr. →..022247	09.00-09.04	TNK	4	<b>0 432 193 480</b>
			Komp.Nr. 505047 05/09/10				
			Mot.Nr. ..022248→	09.00-09.04	TNK	4	<b>0 432 191 526</b>
			Komp.Nr. 505047 /09/11				
. L [LKN]	4,3	112	OM 904.922 LA <Euro2>				
			Mot.Nr. →..022247	01.98-09.04		4	<b>0 432 193 480</b>
			Mot.Nr. ..022248→	01.98-09.04		4	<b>0 432 191 526</b>
<b>1217</b> , KO, L [LKN]	4,3	125	OM 904.911 LA <Euro2>				
			Mot.Nr. →..022247	01.98-09.04		4	<b>0 432 193 480</b>
			Mot.Nr. ..022248→	01.98-09.04		4	<b>0 432 191 526</b>
<b>1218</b> [LKN]	4,3	130	OM 904.951 LA <Euro 3>	09.00-09.04		4	<b>0 432 193 438</b>
<b>1223</b> [LKN]	6,4	170	OM 906.925 LA <Euro3>				
			Komp.Nr. 505047/21	09.00-09.04	TNK	6	<b>0 432 191 301</b>
			Komp.Nr. 505074 /12/15	09.00-09.04	TNK	6	<b>0 432 193 481</b>
			Mot.Nr. →..022247	09.00-09.04		6	<b>0 432 193 480</b>
			Mot.Nr. ..022248→..056812	09.00-09.04		6	<b>0 432 191 526</b>
			Mot.Nr. ..056813→	09.00-09.04		6	<b>0 432 191 278</b>
. L [LKN]	6,4	170	OM 906.910 LA <Euro2>				
			Komp.Nr. 505074 /12/15	01.98-09.04	TNK	6	<b>0 432 193 481</b>
			Mot.Nr. →..022247	01.98-09.04		6	<b>0 432 193 480</b>
			Mot.Nr. ..022248→..056812	01.98-09.04		6	<b>0 432 191 526</b>
			Mot.Nr. ..056813→	01.98-09.04		6	<b>0 432 191 278</b>
<b>1225</b> AF, F [LKN]	6,4	180	OM 906... <Euro 2/3>				
			Komp.Nr. 505074 /12/15	01.98-09.04	TNK	6	<b>0 432 193 481</b>
			Mot.Typ 906.919				
			Mot.Nr. →..022247	01.98-09.04	TW	6	<b>0 432 191 554</b>
			Mot.Nr. →..022247	01.98-09.04		6	<b>0 432 193 480</b>
			Mot.Typ 906.919				
			Mot.Nr. ..022248→..056812	01.98-09.04		6	<b>0 432 191 526</b>
			Mot.Typ 906.919				
			Mot.Nr. ..056813→	01.98-09.04		6	<b>0 432 191 278</b>
			Mot.Typ 906.919				
			Mot.Typ 906.939	01.98-09.04		6	<b>0 432 191 301</b>
<b>1228</b> [LKN]	6,4	205	OM 906.926 LA <Euro3>				
			Komp.Nr. 505047/17	09.00-10.04	TNK	6	<b>0 432 191 302</b>
			Komp.Nr. 505047/21	09.00-10.04	TNK	6	<b>0 432 191 301</b>
			Komp.Nr. 505074 /12/15	09.00-10.04	TNK	6	<b>0 432 193 481</b>
			Mot.Nr. →..022247	09.00-10.04		6	<b>0 432 193 480</b>
			Mot.Nr. ..022248→..056812	09.00-10.04		6	<b>0 432 191 526</b>
			Mot.Nr. ..056813→	09.00-10.04		6	<b>0 432 191 278</b>
. L [LKN]	6,4	205	OM 906.911 LA <Euro2>				
			Komp.Nr. 505074 /12/15	01.98-09.04	TNK	6	<b>0 432 193 481</b>
			Mot.Nr. →..022247	01.98-09.04		6	<b>0 432 193 480</b>
			Mot.Nr. ..022248→..056812	01.98-09.04		6	<b>0 432 191 526</b>
			Mot.Nr. ..056813→	01.98-09.04		6	<b>0 432 191 278</b>
<b>1317</b> , A, AK, KO, L [LKN]	4,3	125	OM 904.911 LA <Euro2>				
			Mot.Nr. →..022247	01.98→		4	<b>0 432 193 480</b>
			Mot.Nr. ..022248→	01.98-09.04		4	<b>0 432 191 526</b>
<b>1318</b> [LKN]	4,3	130	OM 904.951 LA <Euro 3>	09.00-09.04		4	<b>0 432 193 438</b>
<b>1323</b> , L, LKO [LKN]	6,4	170	OM 906.910 LA <Euro2>				
			Komp.Nr. 505074 /12/15	01.98-09.04	TNK	6	<b>0 432 193 481</b>
			Mot.Nr. →..022247	01.98-09.04		6	<b>0 432 193 480</b>
			Mot.Nr. ..022248→..056812	01.98-09.04		6	<b>0 432 191 526</b>
			Mot.Nr. ..056813→	01.98-09.04		6	<b>0 432 191 278</b>





<b>1325 AF, F [LKN]</b>	6,4	180	OM 906... <Euro 2/3>				
			Komp.Nr. 505074 /12/15	01.98-09.04	TNK	6	<b>0 432 193 481</b>
			Mot. Typ 906.919				
			Mot.Nr. →..022247	01.98-09.04	TW	6	<b>0 432 191 554</b>
			Mot.Nr. →..022247	01.98-09.04		6	<b>0 432 193 480</b>
			Mot. Typ 906.919				
			Mot.Nr. ..022248→..056812	01.98-09.04		6	<b>0 432 191 526</b>
			Mot. Typ 906.919				
<b>1328 [LKN]</b>	6,4	205	OM 906.926 LA <Euro3>				
			Komp.Nr. 505047/17	09.00-09.04	TNK	6	<b>0 432 191 302</b>
			Komp.Nr. 505047/21	09.00-09.04	TNK	6	<b>0 432 191 301</b>
			Komp.Nr. 505074 /12/15	09.00-09.04	TNK	6	<b>0 432 193 481</b>
			Mot.Nr. →..022247	09.00-09.04		6	<b>0 432 193 480</b>
			Mot.Nr. ..022248→..056812	09.00-09.04		6	<b>0 432 191 526</b>
			Mot.Nr. ..056813→	09.00-09.04		6	<b>0 432 191 278</b>
, AF, F, L [LKN]	6,4	205	OM 906.911 LA <Euro2>				
			Komp.Nr. 505074 /12/15	01.98-09.04	TNK	6	<b>0 432 193 481</b>
			Mot.Nr. →..022247	01.98-09.04		6	<b>0 432 193 480</b>
			Mot.Nr. ..022248→..056812	01.98-09.04		6	<b>0 432 191 526</b>
<b>1517 , L [LKN]</b>	4,3	125	OM 904.911 LA <Euro2>				
			Mot.Nr. →..022247	01.98-09.04		4	<b>0 432 193 480</b>
			Mot.Nr. ..022248→	01.98-09.04		4	<b>0 432 191 526</b>
<b>1518 [LKN]</b>	4,3	130	OM 904.951 LA <Euro 3>	09.00-09.04		4	<b>0 432 193 438</b>
<b>1523 [LKN]</b>	6,4	170	OM 906.925 LA <Euro3>				
			Komp.Nr. 505047/21	09.00-10.04	TNK	6	<b>0 432 191 301</b>
			Komp.Nr. 505074 /12/15	09.00-10.04	TNK	6	<b>0 432 193 481</b>
			Mot.Nr. →..022247	09.00-10.04		6	<b>0 432 193 480</b>
			Mot.Nr. ..022248→..056812	09.00-10.04		6	<b>0 432 191 526</b>
			Mot.Nr. ..056813→	09.00-10.04		6	<b>0 432 191 278</b>
, A, AK, KO, L [LKN]	6,4	170	OM 906.910 LA <Euro2>				
			Komp.Nr. 505074 /12/15	01.98-09.04	TNK	6	<b>0 432 193 481</b>
			Mot.Nr. →..022247	01.98-09.04		6	<b>0 432 193 480</b>
			Mot.Nr. ..022248→..056812	01.98-09.04		6	<b>0 432 191 526</b>
<b>1525 AF [LKN]</b>	6,4	180	OM 906... <Euro 2/3>				
			Komp.Nr. 505074 /12/15	01.98-09.04	TNK	6	<b>0 432 193 481</b>
			Mot. Typ 906.919				
			Mot.Nr. →..022247	01.98-09.04		6	<b>0 432 193 480</b>
			Mot. Typ 906.919				
			Mot.Nr. ..022248→..056812	01.98-09.04		6	<b>0 432 191 526</b>
			Mot. Typ 906.919				
			Mot.Nr. ..056813→	01.98-09.04		6	<b>0 432 191 278</b>
<b>1528 [LKN]</b>	6,4	205	OM 906.926 LA <Euro3>				
			Komp.Nr. 505047/17	09.00-09.04	TNK	6	<b>0 432 191 302</b>
			Komp.Nr. 505047/21	09.00-09.04	TNK	6	<b>0 432 191 301</b>
			Komp.Nr. 505074 /12/15	09.00-09.04	TNK	6	<b>0 432 193 481</b>
			Mot.Nr. →..022247	09.00-09.04		6	<b>0 432 193 480</b>
			Mot.Nr. ..022248→..056812	09.00-09.04		6	<b>0 432 191 526</b>
			Mot.Nr. ..056813→	09.00-09.04		6	<b>0 432 191 278</b>
, AF, F, L [LKN]	6,4	205	OM 906.911 LA <Euro2>				
			Komp.Nr. 505074 /12/15	01.98-09.04	TNK	6	<b>0 432 193 481</b>
			Mot.Nr. →..022247	01.98-09.04		6	<b>0 432 193 480</b>
			Mot.Nr. ..022248→..056812	01.98-09.04		6	<b>0 432 191 526</b>
			Mot.Nr. ..056813→	01.98-09.04		6	<b>0 432 191 278</b>





◀ MERCEDES-BENZ

<b>1823</b> [LKN]	6,4	170	OM 906.925 LA <Euro3>					
			Komp.Nr. 505047/21	09.00-09.04	TNK	6	<b>0 432 191 301</b>	
			Komp.Nr. 505074 /12/15	09.00-09.04	TNK	6	<b>0 432 193 481</b>	
			Mot.Nr. →..022247	09.00-09.04		6	<b>0 432 193 480</b>	
			Mot.Nr. ...022248→..056812	09.00-09.04		6	<b>0 432 191 526</b>	
			Mot.Nr. ...056813→	09.00-09.04		6	<b>0 432 191 278</b>	
, K, L, LS [LKN]	6,4	170	OM 906.920 LA <Euro2>					
			Komp.Nr. 505074 /12/15	05.98-09.04	TNK	6	<b>0 432 193 481</b>	
			Mot.Nr. →..022247	05.98-09.04		6	<b>0 432 193 480</b>	
			Mot.Nr. ...022248→..056812	05.98-09.04		6	<b>0 432 191 526</b>	
			Mot.Nr. ...056813→	05.98-09.04		6	<b>0 432 191 278</b>	
AK [LKN]	6,4	170	OM 906.922 LA <Euro2>					
			Komp.Nr. 505074 /12/15	05.98-09.04	TNK	6	<b>0 432 193 481</b>	
			Mot.Nr. →..022247	05.98-09.04		6	<b>0 432 193 480</b>	
			Mot.Nr. ...022248→..056812	05.98-09.04		6	<b>0 432 191 526</b>	
			Mot.Nr. ...056813→	05.98-09.04		6	<b>0 432 191 278</b>	
<b>1828</b> [LKN]	6,4	205	OM 906.926 LA <Euro3>					
			Komp.Nr. 505047/17	09.00-09.04	TNK	6	<b>0 432 191 302</b>	
			Komp.Nr. 505047/21	09.00-09.04	TNK	6	<b>0 432 191 301</b>	
			Komp.Nr. 505074 /12/15	09.00-09.04	TNK	6	<b>0 432 193 481</b>	
			Mot.Nr. →..022247	09.00-09.04		6	<b>0 432 193 480</b>	
			Mot.Nr. ...022248→..056812	09.00-09.04		6	<b>0 432 191 526</b>	
			Mot.Nr. ...056813→	09.00-09.04		6	<b>0 432 191 278</b>	
, K, L, LS [LKN]	6,4	205	OM 906.921 LA <Euro2>					
			Komp.Nr. 505074 /12/15	05.98-09.04	TNK	6	<b>0 432 193 481</b>	
			Mot.Nr. →..022247	05.98-09.04		6	<b>0 432 193 480</b>	
			Mot.Nr. ...022248→..056812	05.98-09.04		6	<b>0 432 191 526</b>	
			Mot.Nr. ...056813→	05.98-09.04		6	<b>0 432 191 278</b>	
A, AK [LKN]	6,4	205	OM 906.923 LA <Euro2>					
			Komp.Nr. 505074/12	05.98-09.04	TNK	6	<b>0 432 193 481</b>	
			Komp.Nr. 505074/15					
			<del>Komp.Nr. 505047/06</del>					
			Mot.Nr. →..022247	05.98-09.04		6	<b>0 432 193 480</b>	
			Mot.Nr. ...022248→..056812	05.98-09.04		6	<b>0 432 191 526</b>	
			Mot.Nr. ...056813→	05.98-09.04		6	<b>0 432 191 278</b>	
<b>1833</b> [LKN]	7,2	240	OM 926.913 LA <Euro3>	09.00-09.04		6	<b>0 432 191 303</b>	
<b>2523</b> L [LKN]	6,4	170	OM 906.920 LA <Euro2>					
			Komp.Nr. 505074 /12/15	05.98-09.04	TNK	6	<b>0 432 193 481</b>	
			Mot.Nr. →..022247	05.98-09.04		6	<b>0 432 193 480</b>	
			Mot.Nr. ...022248→..056812	05.98-09.04		6	<b>0 432 191 526</b>	
			Mot.Nr. ...056813→	05.98-09.04		6	<b>0 432 191 278</b>	
<b>2528</b> [LKN]	6,4	205	OM 906.926 LA <Euro3>					
			Komp.Nr. 505047/17	09.00-09.04	TNK	6	<b>0 432 191 302</b>	
			Komp.Nr. 505047/21	09.00-09.04	TNK	6	<b>0 432 191 301</b>	
			Komp.Nr. 505074 /12/15	09.00-09.04	TNK	6	<b>0 432 193 481</b>	
			Mot.Nr. →..022247	09.00-09.04		6	<b>0 432 193 480</b>	
			Mot.Nr. ...022248→..056812	09.00-09.04		6	<b>0 432 191 526</b>	
			Mot.Nr. ...056813→	09.00-09.04		6	<b>0 432 191 278</b>	
L [LKN]	6,4	205	OM 906.921 LA <Euro2>					
			Komp.Nr. 505074 /12/15	05.98-09.04	TNK	6	<b>0 432 193 481</b>	
			Mot.Nr. →..022247	05.98-09.04		6	<b>0 432 193 480</b>	
			Mot.Nr. ...022248→..056812	05.98-09.04		6	<b>0 432 191 526</b>	
			Mot.Nr. ...056813→	05.98-09.04		6	<b>0 432 191 278</b>	
<b>2533</b> [LKN]	7,2	240	OM 926.913 LA <Euro3>	09.00-09.04		6	<b>0 432 191 303</b>	
<b>2628</b> [LKN]	6,4	205	OM 906.926 LA <Euro3>					
			Komp.Nr. 505047/17	09.00-09.04	TNK	6	<b>0 432 191 302</b>	
			Komp.Nr. 505047/21	09.00-09.04	TNK	6	<b>0 432 191 301</b>	
			Komp.Nr. 505074 /12/15	09.00-09.04	TNK	6	<b>0 432 193 481</b>	
			Mot.Nr. →..022247	09.00-09.04		6	<b>0 432 193 480</b>	
			Mot.Nr. ...022248→..056812	09.00-09.04		6	<b>0 432 191 526</b>	
			Mot.Nr. ...056813→	09.00-09.04		6	<b>0 432 191 278</b>	





<b>2628</b> , B, K [LKN]	6,4	205	OM 906.921 LA <Euro2>					
			Komp.Nr. 505074 /12/15	05.98-09.04	TNK	6	<b>0 432 193 481</b>	
			Mot.Nr. →..022247	05.98-09.04		6	<b>0 432 193 480</b>	
			Mot.Nr. ..022248→..056812	05.98-09.04		6	<b>0 432 191 526</b>	
			Mot.Nr. ..056813→	05.98-09.04		6	<b>0 432 191 278</b>	
<b>2633</b> [LKN]	7,2	240	OM 926.913 LA <Euro3>	09.00-09.04		6	<b>0 432 191 303</b>	
<b>Atego II</b>								
<b>716</b> BlueTec	4,3	115	OM 900... <Euro 4/5>					
			Mot.Typ 924.935	02.06→		4	<b>0 432 193 421</b>	
<b>816</b> BlueTec	4,3	115	OM 900... <Euro 4/5>					
			Mot.Typ 924.935	02.06→		4	<b>0 432 193 421</b>	
<b>822</b>	4,8	160	OM 924.920 <Euro 3>	09.04→		4	<b>0 432 191 303</b>	
BlueTec	4,8	160	OM 924.930 LA <Euro 5/EEV>	06.06→		4	<b>0 432 193 421</b>	
<b>823</b>	6,4	170	OM 906.915 <Euro 3>					
			Komp.Nr. 505047 /06	09.04→	TNK	6	<b>0 432 193 480</b>	
			Mot.Nr. →..022247					
			Komp.Nr. 505047/ 21	09.04→	TNK	6	<b>0 432 191 301</b>	
			Komp.Nr. 505074 /12/15	09.04→	TNK	6	<b>0 432 193 481</b>	
			Mot.Nr. ..022248→..056812	09.04→		6	<b>0 432 191 526</b>	
			Komp.Nr. 505047 /06					
			Mot.Nr. ..056813→	09.04→	TNK	6	<b>0 432 191 278</b>	
			Komp.Nr. 505047 /06					
<b>824</b> BlueTec	7,2	175	OM 925.920 <(926 LA) EEV>	10.10→		6	<b>0 432 193 421</b>	
<b>916</b> BlueTec	4,3	115	OM 900... <Euro 4/5>					
			Mot.Typ 924.935	02.06→		4	<b>0 432 193 421</b>	
<b>922</b>	4,8	160	OM 924.920 <Euro 3>	09.04→		4	<b>0 432 191 303</b>	
BlueTec	4,8	160	OM 924.930 LA <Euro 5/EEV>	06.06→		4	<b>0 432 193 421</b>	
<b>923</b>	6,4	170	OM 906.915 <Euro 3>					
			Komp.Nr. 505047 /06	09.04→	TNK	6	<b>0 432 193 480</b>	
			Mot.Nr. →..022247					
			Komp.Nr. 505047/ 21	09.04→	TNK	6	<b>0 432 191 301</b>	
			Komp.Nr. 505074 /12/15	09.04→	TNK	6	<b>0 432 193 481</b>	
			Mot.Nr. ..022248→..056812	09.04→		6	<b>0 432 191 526</b>	
			Komp.Nr. 505047 /06					
			Mot.Nr. ..056813→	09.04→	TNK	6	<b>0 432 191 278</b>	
			Komp.Nr. 505047 /06					
<b>1016</b> BlueTec	4,3	115	OM 900... <Euro 4/5>					
			Mot.Typ 924.935	02.06→		4	<b>0 432 193 421</b>	
<b>1022</b>	4,8	160	OM 924.920 <Euro 3>	09.04→		4	<b>0 432 191 303</b>	
BlueTec	4,8	160	OM 924.930 LA <Euro 5/EEV>	06.06→		4	<b>0 432 193 421</b>	
<b>1023</b>	6,4	170	OM 906.915 <Euro 3>					
			Komp.Nr. 505047 /06	09.04→	TNK	6	<b>0 432 193 480</b>	
			Mot.Nr. →..022247					
			Komp.Nr. 505047/ 21	09.04→	TNK	6	<b>0 432 191 301</b>	
			Komp.Nr. 505074 /12/15	09.04→	TNK	6	<b>0 432 193 481</b>	
			Mot.Nr. ..022248→..056812	09.04→		6	<b>0 432 191 526</b>	
			Komp.Nr. 505047 /06					
			Mot.Nr. ..056813→	09.04→	TNK	6	<b>0 432 191 278</b>	
			Komp.Nr. 505047 /06					
<b>1216</b> BlueTec	4,3	115	OM 900... <Euro 4/5>					
			Mot.Typ 924.935	02.06→		4	<b>0 432 193 421</b>	
<b>1222</b>	4,8	160	OM 924.920 <Euro 3>	09.04→		4	<b>0 432 191 303</b>	
BlueTec	4,8	160	OM 924.930 LA <Euro 5/EEV>	06.06→		4	<b>0 432 193 421</b>	
<b>1223</b>	6,4	170	OM 906.915 <Euro 3>					
			Komp.Nr. 505047 /06	09.04→	TNK	6	<b>0 432 193 480</b>	
			Mot.Nr. →..022247					
			Komp.Nr. 505047/ 21	09.04→	TNK	6	<b>0 432 191 301</b>	
			Komp.Nr. 505074 /12/15	09.04→	TNK	6	<b>0 432 193 481</b>	
			Mot.Nr. ..022248→..056812	09.04→		6	<b>0 432 191 526</b>	
			Komp.Nr. 505047 /06					
			Mot.Nr. ..056813→	09.04→	TNK	6	<b>0 432 191 278</b>	
			Komp.Nr. 505047 /06					
<b>1224</b> BlueTec	7,2	175	OM 925.920 <(926 LA) EEV>	03.10→		6	<b>0 432 193 421</b>	





◀ MERCEDES-BENZ

<b>1226</b> BlueTec	7,2	188	OM 925.920 <(926 LA) EEV>	03.10→		6	<b>0 432 193 421</b>
<b>1228</b>	6,4	205	OM 906.916 <(906) Euro 3>				
			Komp.Nr. 505047 /06	09.04→	TNK	6	<b>0 432 193 480</b>
			Mot.Nr. →..022247				
			Komp.Nr. 505047 /17	09.04→	TNK	6	<b>0 432 191 302</b>
			Komp.Nr. 505074 /12/15	09.04→	TNK	6	<b>0 432 193 481</b>
			Mot.Nr. ..022248→..056812	09.04→		6	<b>0 432 191 526</b>
			Komp.Nr. 505047 /06				
			Mot.Nr. ..056813→	09.04→	TNK	6	<b>0 432 191 278</b>
			Komp.Nr. 505047 /06				
<b>1229</b> BlueTec	7,2	210	OM 925.920 <(926 LA) EEV>	03.10→		6	<b>0 432 193 421</b>
<b>1322</b>	4,8	160	OM 924.920 <Euro 3>	09.04→		4	<b>0 432 191 303</b>
BlueTec	4,8	160	OM 924.930 LA <Euro 5/EEV>	06.06→		4	<b>0 432 193 421</b>
<b>1323</b>	6,4	170	OM 906.915 <Euro 3>				
			Komp.Nr. 505047 /06	09.04→	TNK	6	<b>0 432 193 480</b>
			Mot.Nr. →..022247				
			Komp.Nr. 505047 / 21	09.04→	TNK	6	<b>0 432 191 301</b>
			Komp.Nr. 505074 /12/15	09.04→	TNK	6	<b>0 432 193 481</b>
			Mot.Nr. ..022248→..056812	09.04→		6	<b>0 432 191 526</b>
			Komp.Nr. 505047 /06				
			Mot.Nr. ..056813→	09.04→	TNK	6	<b>0 432 191 278</b>
			Komp.Nr. 505047 /06				
<b>1324</b> BlueTec	7,2	175	OM 925.920 <(926 LA) EEV>	03.10→		6	<b>0 432 193 421</b>
<b>1326</b> BlueTec	7,2	188	OM 925.920 <(926 LA) EEV>	03.10→		6	<b>0 432 193 421</b>
<b>1328</b>	6,4	205	OM 906.916 <(906) Euro 3>				
			Komp.Nr. 505047 /06	09.04→	TNK	6	<b>0 432 193 480</b>
			Mot.Nr. →..022247				
			Komp.Nr. 505047 /17	09.04→	TNK	6	<b>0 432 191 302</b>
			Komp.Nr. 505074 /12/15	09.04→	TNK	6	<b>0 432 193 481</b>
			Mot.Nr. ..022248→..056812	09.04→		6	<b>0 432 191 526</b>
			Komp.Nr. 505047 /06				
			Mot.Nr. ..056813→	09.04→	TNK	6	<b>0 432 191 278</b>
			Komp.Nr. 505047 /06				
<b>1329</b> BlueTec	7,2	210	OM 925.920 <(926 LA) EEV>	03.10→		6	<b>0 432 193 421</b>
<b>1522</b>	4,8	160	OM 924.920 <Euro 3>	09.04→		4	<b>0 432 191 303</b>
BlueTec	4,8	160	OM 924.930 LA <Euro 5/EEV>	06.06→		4	<b>0 432 193 421</b>
<b>1523</b>	6,4	170	OM 906.915 <Euro 3>				
			Komp.Nr. 505047 /06	09.04→	TNK	6	<b>0 432 193 480</b>
			Mot.Nr. →..022247				
			Komp.Nr. 505047 / 21	09.04→	TNK	6	<b>0 432 191 301</b>
			Komp.Nr. 505074 /12/15	09.04→	TNK	6	<b>0 432 193 481</b>
			Mot.Nr. ..022248→..056812	09.04→		6	<b>0 432 191 526</b>
			Komp.Nr. 505047 /06				
			Mot.Nr. ..056813→	09.04→	TNK	6	<b>0 432 191 278</b>
			Komp.Nr. 505047 /06				
<b>1524</b> BlueTec	7,2	175	OM 925.920 <(926 LA) EEV>	03.10→		6	<b>0 432 193 421</b>
<b>1526</b> BlueTec	7,2	188	OM 925.920 <(926 LA) EEV>	03.10→		6	<b>0 432 193 421</b>
<b>1528</b>	6,4	205	OM 906.916 <(906) Euro 3>				
			Komp.Nr. 505047 /06	09.04→	TNK	6	<b>0 432 193 480</b>
			Mot.Nr. →..022247				
			Komp.Nr. 505047 /17	09.04→	TNK	6	<b>0 432 191 302</b>
			Komp.Nr. 505074 /12/15	09.04→	TNK	6	<b>0 432 193 481</b>
			Mot.Nr. ..022248→..056812	09.04→		6	<b>0 432 191 526</b>
			Komp.Nr. 505047 /06				
			Mot.Nr. ..056813→	09.04→	TNK	6	<b>0 432 191 278</b>
			Komp.Nr. 505047 /06				
<b>1529</b> BlueTec	7,2	210	OM 925.920 <(926 LA) EEV>	03.10→		6	<b>0 432 193 421</b>





Axor							
<b>1823</b>	6,4	170	OM 906...				
			Komp.Nr. 505047/ 21	01.02-08.06	TNK	6	<b>0 432 191 301</b>
			Komp.Nr. 505074 /12/15	01.02-08.06	TNK	6	<b>0 432 193 481</b>
			Mot.Nr. →..022247	01.02-08.06	TNK	6	<b>0 432 193 480</b>
			Komp.Nr. 505047/ 06				
			Mot.Nr. ..022248→..056812	01.02-08.06	TNK	6	<b>0 432 191 526</b>
			Komp.Nr. 505047/ 06				
			Mot.Nr. ..056813→	01.02-08.06	TNK	6	<b>0 432 191 278</b>
			Komp.Nr. 505047 /06				
<b>1828</b>	6,4	205	OM 906...				
			Komp.Nr. 505047 /17	01.02-08.06	TNK	6	<b>0 432 191 302</b>
			Komp.Nr. 505074 /12/15	01.02-08.06	TNK	6	<b>0 432 193 481</b>
			Mot.Nr. →..022247	01.02-08.06	TNK	6	<b>0 432 193 480</b>
			Komp.Nr. 505047/ 06				
			Mot.Nr. ..022248→..056812	01.02-08.06	TNK	6	<b>0 432 191 526</b>
			Komp.Nr. 505047/ 06				
			Mot.Nr. ..056813→	01.02-08.06	TNK	6	<b>0 432 191 278</b>
			Komp.Nr. 505047 /06				
<b>1835 LS</b>	11,7	260	OM 457.937 LA				
			Komp.Nr. 522003/ 02/09	01.02-08.06	TNK	6	<b>0 432 191 263</b>
			Komp.Nr. 522003/01	01.02-08.06	TNK	6	<b>0 432 191 551</b>
			Komp.Nr. 522003/08	01.02-08.06	TNK	6	<b>0 432 191 258</b>
			Komp.Nr. 505137/25/26				
			Komp.Nr. 522003/18	01.02-08.06	TNK	6	<b>0 432 193 449</b>
<b>1840 LS</b>	12,0	295	OM 457.937 LA				
			Komp.Nr. 522003/ 02/09	01.02-08.06	TNK	6	<b>0 432 191 263</b>
			Komp.Nr. 522003/01	01.02-08.06	TNK	6	<b>0 432 191 551</b>
			Komp.Nr. 522003/08	01.02-08.06	TNK	6	<b>0 432 191 258</b>
			Komp.Nr. 505137/25/26				
			Komp.Nr. 522003/18	01.02-08.06	TNK	6	<b>0 432 193 449</b>
<b>1843 LS</b>	11,7	315	OM 457.937 LA				
			Komp.Nr. 522003/ 02/09	01.02-08.06	TNK	6	<b>0 432 191 263</b>
			Komp.Nr. 522003/01	01.02-08.06	TNK	6	<b>0 432 191 551</b>
			Komp.Nr. 522003/08	01.02-08.06	TNK	6	<b>0 432 191 258</b>
			Komp.Nr. 505137/25/26				
			Komp.Nr. 522003/18	01.02-08.06	TNK	6	<b>0 432 193 449</b>
<b>2523</b>	6,4	170	OM 906.920 LA				
			Komp.Nr. 505074 /12/15	01.02-08.06	TNK	6	<b>0 432 193 481</b>
			Mot.Nr. →..022247	01.02-08.06		6	<b>0 432 193 480</b>
			Mot.Nr. ..022248→..056812	01.02-08.06		6	<b>0 432 191 526</b>
			Mot.Nr. ..056813→	01.02-08.06		6	<b>0 432 191 278</b>
<b>2528</b>	6,4	205	OM 906.921 LA				
			Komp.Nr. 505074 /12/15	01.02-08.06	TNK	6	<b>0 432 193 481</b>
			Mot.Nr. →..022247	01.02-08.06		6	<b>0 432 193 480</b>
			Mot.Nr. ..022248→..056812	01.02-08.06		6	<b>0 432 191 526</b>
			Mot.Nr. ..056813→	01.02-08.06		6	<b>0 432 191 278</b>
<b>2535 LS</b>	11,7	260	OM 457.937 LA				
			Komp.Nr. 522003/ 02/09	01.02-08.06	TNK	6	<b>0 432 191 263</b>
			Komp.Nr. 522003/01	01.02-08.06	TNK	6	<b>0 432 191 551</b>
			Komp.Nr. 522003/08	01.02-08.06	TNK	6	<b>0 432 191 258</b>
			Komp.Nr. 505137/25/26				
			Komp.Nr. 522003/18	01.02-08.06	TNK	6	<b>0 432 193 449</b>
<b>2540 LS</b>	11,7	295	OM 457.937 LA				
			Komp.Nr. 522003/ 02/09	01.02-08.06	TNK	6	<b>0 432 191 263</b>
			Komp.Nr. 522003/01	01.02-08.06	TNK	6	<b>0 432 191 551</b>
			Komp.Nr. 522003/08	01.02-08.06	TNK	6	<b>0 432 191 258</b>
			Komp.Nr. 505137/25/26				
			Komp.Nr. 522003/18	01.02-08.06	TNK	6	<b>0 432 193 449</b>





◀ MERCEDES-BENZ

<b>2543LS</b>	11,7	315	OM 457.937 LA				
			Komp.Nr. 522003/ 02/09	01.02-08.06	TNK	6	<b>0 432 191 263</b>
			Komp.Nr. 522003/01	01.02-08.06	TNK	6	<b>0 432 191 551</b>
			Komp.Nr. 522003/08	01.02-08.06	TNK	6	<b>0 432 191 258</b>
			Komp.Nr. 505137/25/26				
			Komp.Nr. 522003/18	01.02-08.06	TNK	6	<b>0 432 193 449</b>
<b>2628</b>	6,4	205	OM 906.921 LA				
			Komp.Nr. 505074 /12/15	01.02-08.06	TNK	6	<b>0 432 193 481</b>
			Mot.Nr. →..022247	01.02-08.06		6	<b>0 432 193 480</b>
			Mot.Nr. ...022248→..056812	01.02-08.06		6	<b>0 432 191 526</b>
			Mot.Nr. ...056813→	01.02-08.06		6	<b>0 432 191 278</b>
<b>3028</b>	6,4	205	OM 906.921 <OM 906 LA>				
			Komp.Nr. 505074 /12/15	03.03→	TNK	6	<b>0 432 193 481</b>
			Mot.Nr. →..022247	03.03→	TNK	6	<b>0 432 193 480</b>
			Komp.Nr. 505047/06				
			Mot.Nr. ...022248→..056812	03.03→	TNK	6	<b>0 432 191 526</b>
			Komp.Nr. 505047/06				
			Mot.Nr. ...056813→	03.03→	TNK	6	<b>0 432 191 278</b>
<b>Axor II</b>							
<b>1833</b>	7,2	240	OM 926...	09.04-08.06		6	<b>0 432 191 303</b>
			OM 926.945 LA <Euro 5/EEV (BlueTec)>	12.09→		6	<b>0 432 193 421</b>
<b>1836</b>	12,0	265	OM 457.948 LA <Euro 4/5 (BlueTec)>				
			Komp.Nr. 522003/13	09.06→	TNK	6	<b>0 432 191 219</b>
			Komp.Nr. 522003/20	09.06→	TNK	6	<b>0 432 193 419</b>
<b>1840</b>	12,0	295	OM 457.948 LA <Euro 4/5 (BlueTec)>				
			Komp.Nr. 522003/13	09.06→	TNK	6	<b>0 432 191 219</b>
			Komp.Nr. 522003/20	09.06→	TNK	6	<b>0 432 193 419</b>
<b>1843</b>	12,0	315	OM 457.948 LA <Euro 4/5 (BlueTec)>				
			Komp.Nr. 522003/13	09.06→	TNK	6	<b>0 432 191 219</b>
			Komp.Nr. 522003/20	09.06→	TNK	6	<b>0 432 193 419</b>
<b>2533</b>	7,2	240	OM 926.945 LA <Euro 5/EEV (BlueTec)>	12.09→		6	<b>0 432 193 421</b>
<b>2536</b>	12,0	265	OM 457.948 LA <Euro 4/5 (BlueTec)>				
			Komp.Nr. 522003/13	09.06→	TNK	6	<b>0 432 191 219</b>
			Komp.Nr. 522003/20	09.06→	TNK	6	<b>0 432 193 419</b>
<b>2540</b>	12,0	295	OM 457.948 LA <Euro 4/5 (BlueTec)>				
			Komp.Nr. 522003/13	09.06→	TNK	6	<b>0 432 191 219</b>
			Komp.Nr. 522003/20	09.06→	TNK	6	<b>0 432 193 419</b>
<b>2543</b>	12,0	315	OM 457.948 LA <Euro 4/5 (BlueTec)>				
			Komp.Nr. 522003/13	09.06→	TNK	6	<b>0 432 191 219</b>
			Komp.Nr. 522003/20	09.06→	TNK	6	<b>0 432 193 419</b>
<b>2633</b>	7,2	240	OM 926.945 LA <Euro 5/EEV (BlueTec)>	12.09→		6	<b>0 432 193 421</b>
<b>2635</b>	12,0	260	OM 457.956 <(457 LA) Euro 3>				
			Komp.Nr. 505137/ 03	09.04→	TNK	6	<b>0 432 191 446</b>
			Komp.Nr. 505137 /05	09.04→	TNK	6	<b>0 432 191 459</b>
			Komp.Nr. 505137 /10	09.04→	TNK	6	<b>0 432 191 258</b>
			Komp.Nr. 522003 /08				
			Komp.Nr. 522003/18	09.04→		6	<b>0 432 193 449</b>
<b>2636</b>	12,0	265	OM 457... <Euro 4/5 (BlueTec)>				
			Mot.Typ 457.957	09.06→	TW	6	<b>0 432 191 219</b>
						6	<b>0 432 193 419</b>
<b>2640</b>	12,0	295	OM 457... <Euro 4/5 (BlueTec)>				
			Mot.Typ 457.957	09.06→	TW	6	<b>0 432 191 219</b>
						6	<b>0 432 193 419</b>
<b>2643</b>	12,0	315	OM 457... <Euro 4/5 (BlueTec)>				
			Mot.Typ 457.957	09.06→	TW	6	<b>0 432 191 219</b>
						6	<b>0 432 193 419</b>
<b>3236</b>	12,0	265	OM 457... <Euro 4/5 (BlueTec)>				
			Mot.Typ 457.957	09.06→	TW	6	<b>0 432 191 219</b>
						6	<b>0 432 193 419</b>
<b>3240</b>	12,0	295	OM 457... <Euro 4/5 (BlueTec)>				
			Mot.Typ 457.957	09.06→	TW	6	<b>0 432 191 219</b>
						6	<b>0 432 193 419</b>







3243	12,0	315	OM 457... <Euro 4/5 (BlueTec)> Mot.Typ 457.957	09.06→	TW	6	<b>0 432 191 219</b>
						6	<b>0 432 193 419</b>
3335	12,0	260	OM 457.956 LA <Euro 3> Komp.Nr. 505137/ 03	09.04→	TNK	6	<b>0 432 191 446</b>
			Komp.Nr. 505137 /05	09.04→	TNK	6	<b>0 432 191 459</b>
			Komp.Nr. 505137 /10	09.04→	TNK	6	<b>0 432 191 258</b>
			Komp.Nr. 522003 /08				
			Komp.Nr. 522003/18	09.04→		6	<b>0 432 193 449</b>
3340	12,0	295	OM 457.956 LA <Euro 3> Komp.Nr. 505137/ 03	09.04→	TNK	6	<b>0 432 191 446</b>
			Komp.Nr. 505137 /05	09.04→	TNK	6	<b>0 432 191 459</b>
			Komp.Nr. 505137 /10	09.04→	TNK	6	<b>0 432 191 258</b>
			Komp.Nr. 522003 /08				
			Komp.Nr. 522003/18	09.04→		6	<b>0 432 193 449</b>
3343	12,0	315	OM 457.956 LA <Euro 3> Komp.Nr. 505137/ 03	09.04→	TNK	6	<b>0 432 191 446</b>
			Komp.Nr. 505137 /05	09.04→	TNK	6	<b>0 432 191 459</b>
			Komp.Nr. 505137 /10	09.04→	TNK	6	<b>0 432 191 258</b>
			Komp.Nr. 522003 /08				
			Komp.Nr. 522003/18	09.04→		6	<b>0 432 193 449</b>
4135	12,0	260	OM 457.956 <(457 LA) Euro 3> Komp.Nr. 505137/ 03	09.04→	TNK	6	<b>0 432 191 446</b>
			Komp.Nr. 505137 /05	09.04→	TNK	6	<b>0 432 191 459</b>
			Komp.Nr. 505137 /10	09.04→	TNK	6	<b>0 432 191 258</b>
			Komp.Nr. 522003 /08				
			Komp.Nr. 522003/18	09.04→		6	<b>0 432 193 449</b>
4140	12,0	295	OM 457.956 <(457 LA) Euro 3> Komp.Nr. 505137/ 03	09.04→	TNK	6	<b>0 432 191 446</b>
			Komp.Nr. 505137 /05	09.04→	TNK	6	<b>0 432 191 459</b>
			Komp.Nr. 505137 /10	09.04→	TNK	6	<b>0 432 191 258</b>
			Komp.Nr. 522003 /08				
			Komp.Nr. 522003/18	09.04→		6	<b>0 432 193 449</b>
			OM 457.957 <Euro 4/5 (BlueTec)> Komp.Nr. 522003/13	09.06→	TNK	6	<b>0 432 191 219</b>
			Komp.Nr. 522003/20	09.06→	TNK	6	<b>0 432 193 419</b>
4143	12,0	315	OM 457.956 <(457 LA) Euro 3> Komp.Nr. 505137/ 03	09.04→	TNK	6	<b>0 432 191 446</b>
			Komp.Nr. 505137 /05	09.04→	TNK	6	<b>0 432 191 459</b>
			Komp.Nr. 505137 /10	09.04→	TNK	6	<b>0 432 191 258</b>
			Komp.Nr. 522003 /08				
			Komp.Nr. 522003/18	09.04→		6	<b>0 432 193 449</b>
			OM 457.957 <Euro 4/5 (BlueTec)> Komp.Nr. 522003/13	09.06→	TNK	6	<b>0 432 191 219</b>
			Komp.Nr. 522003/20	09.06→	TNK	6	<b>0 432 193 419</b>
<b>Citro</b>							
0 530	7,2	210	OM 926... <Euro 4 (BlueTec)> Mot.Typ 926.949	10.06→		6	<b>0 432 193 421</b>
, G	12,0	260	OM 457... <Euro 4/5 (BlueTec)> Komp.Nr. 522003/13	10.06→	TNK	6	<b>0 432 191 219</b>
			Komp.Nr. 522003/20	10.06→	TNK	6	<b>0 432 193 419</b>
, G, GL CapaCity, GUE, L, Low Entry MUE, Low Entry UE, UE	12,0	220-260	OM 457... <Euro 4/5 (BlueTec)> Mot.Typ 457.950,959	10.06→	TW	6	<b>0 432 191 219</b>
						6	<b>0 432 193 419</b>
GNUE3, GN3, GN3 UESTRA, N3	12,0	185	OM 457.935 HLA <Euro 2> Komp.Nr. 505137 /03	01.98-09.04		6	<b>0 432 191 400</b>
			Komp.Nr. 505137/05	01.98-09.04	TNK	6	<b>0 432 191 446</b>
			Komp.Nr. 505137/06	01.98-09.04	TNK	6	<b>0 432 191 459</b>
			Komp.Nr. 522003/03				
			Komp.Nr. 505137/10	01.98-09.04	TNK	6	<b>0 432 191 384</b>
			Komp.Nr. 505137/11				
			Komp.Nr. 522003/01	01.98-09.04	TNK	6	<b>0 432 191 551</b>
			Komp.Nr. 522006/06	01.98-09.04	TNK	6	<b>0 432 191 407</b>





◀ MERCEDES-BENZ

0 530 GNUE3, GN3, GN3 UESTRA, N3	12,0	220	OM 457.934 HLA <Euro 2>					
			Komp.Nr. 505137/05	01.98-09.04	TNK	6	<b>0 432 191 459</b>	
			Komp.Nr. 505137/06					
			Komp.Nr. 522003/03					
			Komp.Nr. 505137/10	01.98-09.04	TNK	6	<b>0 432 191 384</b>	
			Komp.Nr. 505137/11					
			Komp.Nr. 522003/01	01.98-09.04	TNK	6	<b>0 432 191 551</b>	
GNUE3, GN3, GN3 UESTRA, N3 UESTRA, N3/NUE3	6,4	205	OM 909.901 LA <Euro 2>					
			Komp.Nr. 505074/12/15	01.99-09.04	TNK	6	<b>0 432 193 481</b>	
			Mot.Nr. →..022247	01.99-09.04		6	<b>0 432 193 480</b>	
GNUE3, GN3, N3	12,0	260	OM 457.933 HLA <Euro 2>					
			Komp.Nr. 505137/03	01.98-09.04	TNK	6	<b>0 432 191 446</b>	
			Komp.Nr. 505137/05	01.98-09.04	TNK	6	<b>0 432 191 459</b>	
GNUE3, GN3, N3/NUE3	0,0	205	Komp.Nr. 505137/06					
			Komp.Nr. 522003/03					
			Komp.Nr. 505137/10	01.98-09.04	TNK	6	<b>0 432 191 384</b>	
			Komp.Nr. 505137/11					
			Komp.Nr. 522003/01	01.98-09.04	TNK	6	<b>0 432 191 551</b>	
			Komp.Nr. 522003/07	01.98-09.04	TNK	6	<b>0 432 191 400</b>	
			Komp.Nr. 522006/06	01.98-09.04	TNK	6	<b>0 432 191 407</b>	
GN3, NUE3, N3	6,4	205	OM 906.960 LA <Euro 3>					
			Komp.Nr. 505047/17	04.99-09.06	TNK	6	<b>0 432 191 302</b>	
			Komp.Nr. 505047/39	04.99-09.06	TNK	6	<b>0 432 193 438</b>	
			Komp.Nr. 505074/12/15	04.99-09.06	TNK	6	<b>0 432 193 481</b>	
GN3, NUE3, N3, N3 UESTRA	12,0	185-260	OM 457.942 HLA <Euro 3>					
			Komp.Nr. 505137/03	04.99-10.06	TNK	6	<b>0 432 191 446</b>	
			Komp.Nr. 505137/05	04.99-10.06	TNK	6	<b>0 432 191 459</b>	
			Komp.Nr. 505137/06					
			Komp.Nr. 522003/03					
			Komp.Nr. 522003/02/09	04.99-10.06	TNK	6	<b>0 432 191 263</b>	
			Komp.Nr. 522003/08	04.99-10.06	TNK	6	<b>0 432 191 258</b>	
GN3, N3	6,4	205	OM 906.930 HLA <Euro 2>					
			Komp.Nr. 505074/12/15	01.98-09.04	TNK	6	<b>0 432 193 481</b>	
			Mot.Nr. →..022247	01.98-09.04		6	<b>0 432 193 480</b>	
			Mot.Nr. →..022248→..056812	01.98-09.04		6	<b>0 432 191 526</b>	
Low Entry	12,0	220-260	OM 906.961 <Euro 3>					
			Komp.Nr. 505137/25/26	01.98-09.04		6	<b>0 432 191 278</b>	
			Komp.Nr. 505047/17	04.00-09.06	TNK	6	<b>0 432 191 302</b>	
N3	6,4	180	Komp.Nr. 505047/39	04.00-09.06	TNK	6	<b>0 432 193 438</b>	
			OM 457.941 HLA <Euro 3>					
			Komp.Nr. 522003/02/09	09.05-09.06	TNK	6	<b>0 432 191 263</b>	
			Komp.Nr. 522003/08	09.05-09.06	TNK	6	<b>0 432 191 258</b>	
N3	6,4	180	Komp.Nr. 505137/25/26					
			Komp.Nr. 522003/18	09.05-09.06	TNK	6	<b>0 432 193 449</b>	
			OM 906.962 <Euro 3>					
			Komp.Nr. 505047/21	04.00-09.06	TNK	6	<b>0 432 191 301</b>	
N3	6,4	180	Komp.Nr. 505047/40	04.00-09.06	TNK	6	<b>0 432 191 394</b>	
			OM 906.963 HLA <Euro 3>					
			Komp.Nr. 505047/21	04.99-09.06	TNK	6	<b>0 432 191 301</b>	
			Komp.Nr. 505047/40	04.99-09.06	TNK	6	<b>0 432 191 394</b>	





<b>0 530 N3</b>	12,0	195	OM 457.943 LA <Euro 3>							
			Komp.Nr. 505137 /03	04.00-09.06	TNK	6	<b>0 432 191 446</b>			
			Komp.Nr. 505137/05	04.00-09.06	TNK	6	<b>0 432 191 459</b>			
			Komp.Nr. 505137/06							
			Komp.Nr. 522003/03							
			Komp.Nr. 522003/02/09	04.00-09.06	TNK	6	<b>0 432 191 263</b>			
N3/NUE3	0,0	170	OM 906.931 HLA <Euro 2>							
			Komp.Nr. 505074 /12/15	01.98-09.04	TNK	6	<b>0 432 193 481</b>			
			Mot.Nr. →..022247	01.98-09.04		6	<b>0 432 193 480</b>			
			Mot.Nr. ..022248→..056812	01.98-09.04		6	<b>0 432 191 526</b>			
			Mot.Nr. ..056813→	01.98-09.04		6	<b>0 432 191 278</b>			
6,4	170	OM 909.900,911 LA <Euro 2>	Komp.Nr. 505074 /12/15	01.99-09.04	TNK	6	<b>0 432 193 481</b>			
			Mot.Nr. →..022247	01.99-09.04		6	<b>0 432 193 480</b>			
			Mot.Nr. ..022248→..056812	01.99-09.04		6	<b>0 432 191 526</b>			
			Mot.Nr. ..056813→	01.99-09.04		6	<b>0 432 191 278</b>			
<b>Citro L</b>										
<b>0 530 N3</b>	0,0	205	OM 906.960 LA <Euro 3>							
			Komp.Nr. 505047/17	01.01-09.06	TNK	6	<b>0 432 191 302</b>			
			Komp.Nr. 505047/39	01.01-09.06	TNK	6	<b>0 432 193 438</b>			
			Komp.Nr. 505074 /12/15	01.01-09.06	TNK	6	<b>0 432 193 481</b>			
			OM 909.921 LA <Euro 2>							
			Komp.Nr. 505074 /12/15	01.99-09.04	TNK	6	<b>0 432 193 481</b>			
			Mot.Nr. →..022247	01.99-09.04		6	<b>0 432 193 480</b>			
			Mot.Nr. ..022248→..056812	01.99-09.04		6	<b>0 432 191 526</b>			
			Mot.Nr. ..056813→	01.99-09.04		6	<b>0 432 191 278</b>			
			6,4	205	OM 906.930 HLA <Euro 2>	Komp.Nr. 505074 /12/15	01.99-09.04	TNK	6	<b>0 432 193 481</b>
						Mot.Nr. →..022247	01.99-09.04		6	<b>0 432 193 480</b>
						Mot.Nr. ..022248→..056812	01.99-09.04		6	<b>0 432 191 526</b>
						Mot.Nr. ..056813→	01.99-09.04		6	<b>0 432 191 278</b>
			OM 909.901 LA <Euro 2>	Komp.Nr. 505074 /12/15	01.99-09.04	TNK	6	<b>0 432 193 481</b>		
				Mot.Nr. →..022247	01.99-09.04		6	<b>0 432 193 480</b>		
				Mot.Nr. ..022248→..056812	01.99-09.04		6	<b>0 432 191 526</b>		
				Mot.Nr. ..056813→	01.99-09.04		6	<b>0 432 191 278</b>		
			12,0	185	OM 457.935 HLA <Euro 2>		01.99-09.04		6	<b>0 432 191 400</b>
						Komp.Nr. 505137 /03	01.99-09.04	TNK	6	<b>0 432 191 446</b>
						Komp.Nr. 505137/05	01.99-09.04	TNK	6	<b>0 432 191 459</b>
Komp.Nr. 505137/06										
Komp.Nr. 522003/03										
Komp.Nr. 505137/10	01.99-09.04	TNK				6	<b>0 432 191 384</b>			
Komp.Nr. 505137/11										
Komp.Nr. 522003/01	01.99-09.04	TNK				6	<b>0 432 191 551</b>			
Komp.Nr. 522006/06	01.99-09.04	TNK				6	<b>0 432 191 407</b>			
220	OM 457.934 HLA <Euro 2>	Komp.Nr. 505137/05				01.99-09.04	TNK	6	<b>0 432 191 459</b>	
		Komp.Nr. 505137/06								
		Komp.Nr. 522003/03								
		Komp.Nr. 505137/10	01.99-09.04	TNK	6	<b>0 432 191 384</b>				
		Komp.Nr. 505137/11								
		Komp.Nr. 522003/01	01.99-09.04	TNK	6	<b>0 432 191 551</b>				
Komp.Nr. 522003/07	01.99-09.04	TNK	6	<b>0 432 191 400</b>						
Komp.Nr. 522006/06	01.99-09.04	TNK	6	<b>0 432 191 407</b>						
<b>Cito</b>										
<b>0 520</b>	4,3	125	OM 904 LA <Euro 2>	01.99-09.03		4	<b>0 432 193 480</b>			
<b>Conecto</b>										
<b>G</b>	12,0	260	OM 457... <Euro 4/5>							
			Komp.Nr. 522003/13	09.07→	TNK	6	<b>0 432 191 219</b>			
			Komp.Nr. 522003/20	09.07→	TNK	6	<b>0 432 193 419</b>			





◀ MERCEDES-BENZ

<b>0 345</b>	6,4	205	OM 906.960 (906 LA) <Euro 2>					
			Komp.Nr. 505047 /17	05.01-08.07	TNK	6	<b>0 432 191 302</b>	
			Komp.Nr. 505047 /39	05.01-08.07	TNK	6	<b>0 432 193 438</b>	
			Komp.Nr. 505074 /12/15	05.01-08.07	TNK	6	<b>0 432 193 481</b>	
12,0	185-260	OM 457.942 (457 HLA) <Euro 3>						
		Komp.Nr. 505137 /03	10.01-08.07	TNK	6	<b>0 432 191 446</b>		
		Komp.Nr. 505137 /05	10.01-08.07	TNK	6	<b>0 432 191 459</b>		
		Komp.Nr. 522003 /02/09	10.01-08.07	TNK	6	<b>0 432 191 263</b>		
		Komp.Nr. 522003/08	10.01-08.07	TNK	6	<b>0 432 191 258</b>		
		Komp.Nr. 505137/25/26						
Komp.Nr. 522003/18	10.01-08.07	TNK	6	<b>0 432 193 449</b>				
<b>Econic</b>								
<b>1823L</b>	6,4	170	OM 906...					
			Komp.Nr. 505074 /12/15	03.98-03.01	TNK	6	<b>0 432 193 481</b>	
			Mot.Nr. →..022247	03.98-03.01		6	<b>0 432 193 480</b>	
			Mot.Nr. ...022248→..056812	03.98-03.01		6	<b>0 432 191 526</b>	
			Mot.Nr. ...056813→	03.98-03.01		6	<b>0 432 191 278</b>	
OM 906.951 LA <Euro 3>	03.00-09.06		6	<b>0 432 191 301</b>				
<b>1828L</b>	6,4	205	OM 906.941 LA <Euro 2>					
			Komp.Nr. 505074 /12/15	03.98-03.01	TNK	6	<b>0 432 193 481</b>	
			Mot.Nr. →..022247	03.98-03.01		6	<b>0 432 193 480</b>	
			Mot.Nr. ...022248→..056812	03.98-03.01		6	<b>0 432 191 526</b>	
			Mot.Nr. ...056813→	03.98-03.01		6	<b>0 432 191 278</b>	
OM 906.950 LA <Euro 3>; OM 906.952 LA <Euro 3>	07.98-09.06		6	<b>0 432 191 302</b>				
<b>2628L</b>	6,4	205	OM 906.941 LA <Euro 2>					
			Komp.Nr. 505074 /12/15	03.98-03.01	TNK	6	<b>0 432 193 481</b>	
			Mot.Nr. →..022247	03.98-03.01		6	<b>0 432 193 480</b>	
			Mot.Nr. ...022248→..056812	03.98-03.01		6	<b>0 432 191 526</b>	
			Mot.Nr. ...056813→	03.98-03.01		6	<b>0 432 191 278</b>	
OM 906.952 LA <Euro 3>	03.00-09.06		6	<b>0 432 191 302</b>				
<b>Integro I</b>								
<b>0 550 Ü, ÜH</b>	12,0	184-260	OM 447 HLA Euro 2 <447.903>	09.99-09.06	X10	6	<b>0 432 131 780</b> †	
					X56	6	<b>0 432 131 781</b>	<b>0 986 430 361</b>
<b>Integro II</b>								
<b>L</b>	12,0	220-300	OM 457... <Euro 4/5 (BlueTec)>					
			Mot.Typ 457.952/964/965	09.06→	TW	6	<b>0 432 191 219</b>	
						6	<b>0 432 193 419</b>	
<b>M</b>	12,0	220-300	OM 457... <Euro 4/5 (BlueTec)>					
			Mot.Typ 457.952/964/965	09.06→	TW	6	<b>0 432 191 219</b>	
						6	<b>0 432 193 419</b>	
<b>Intouro</b>								
<b>0 560</b>	11,0	250	OM 441 LA Euro 2	01.00-03.07		6	<b>0 432 131 726</b>	<b>0 986 430 326</b>
					X10	6	<b>0 432 131 730</b> †	
<b>MB</b>								
<b>90</b>	2,0	43	OM 615.963,970					
			Mot.Typ 615.963	03.85-12.86		4	<b>0 432 217 143</b>	
			Mot.Typ 615.970	05.86-12.86		4	<b>0 432 217 131</b>	<b>0 986 430 022</b>
<b>100</b>	2,0	43	OM 615.970	01.87-06.89		4	<b>0 432 217 131</b>	<b>0 986 430 022</b>
			Mot.Typ 615.963	01.85-12.86		4	<b>0 432 217 143</b>	
			Mot.Typ 615.970	05.86-12.86		4	<b>0 432 217 131</b>	<b>0 986 430 022</b>
	2,3	58	OM 661.911	01.96→		4	<b>0 432 217 157</b>	<b>0 986 430 197</b>
	2,9	69,8	OM 662.911	01.96→		5	<b>0 432 217 157</b>	<b>0 986 430 197</b>
<b>D</b>	2,4	53-56	OM 616.963					
			Mot.Nr. →..126321	09.87-05.90		4	<b>0 432 217 131</b>	<b>0 986 430 022</b>
			Mot.Nr. ...126322→	06.90-01.96		4	<b>0 432 217 161</b>	<b>0 986 430 172</b>
	55		OM 616.963					
			Mot.Nr. →..126321	09.91-01.96		4	<b>0 432 217 131</b>	<b>0 986 430 022</b>





<b>120</b>	2,4	55	OM 616.963					
			Mot.Nr. →..126321	01.87-05.90	4	<b>0 432 217 131</b>	<b>0 986 430 022</b>	
			Mot.Nr. ..126322→	06.90-12.90	4	<b>0 432 217 161</b>	<b>0 986 430 172</b>	
<b>140</b>	2,4	53	OM 616.961	10.83-07.86	4	<b>0 432 217 054</b>		
				08.86-12.86	4	<b>0 432 217 142</b>	<b>0 986 430 020</b>	
		56	OM 616.963					
			Mot.Nr. →..126321	01.87-05.90	4	<b>0 432 217 131</b>	<b>0 986 430 022</b>	
			Mot.Nr. ..126322→	06.90-06.90	4	<b>0 432 217 161</b>	<b>0 986 430 172</b>	
<b>160</b>	2,4	56	OM 616.963					
			Mot.Nr. →..126321	01.87-05.90	4	<b>0 432 217 131</b>	<b>0 986 430 022</b>	
			Mot.Nr. ..126322→	06.90-06.90	4	<b>0 432 217 161</b>	<b>0 986 430 172</b>	
<b>180</b>	2,4	53	OM 616.961	10.83-07.86	4	<b>0 432 217 054</b>		
				08.86-12.86	4	<b>0 432 217 142</b>	<b>0 986 430 020</b>	
		56	OM 616.963					
			Mot.Nr. →..126321	01.87-05.90	4	<b>0 432 217 131</b>	<b>0 986 430 022</b>	
			Mot.Nr. ..126322→	06.90-01.96	4	<b>0 432 217 161</b>	<b>0 986 430 172</b>	
<b>800</b>	4,0	85	380... <OM 364 A>	07.96→	4	<b>0 432 231 823</b>	<b>0 986 430 045</b>	
<b>O 100</b>								
<b>CITY</b>	2,9	70	OM 602.940	01.94→	5	<b>0 432 217 161</b>	<b>0 986 430 172</b>	
<b>O 301</b>								
	6,0	100	OM 366.917	06.86-05.87	6	<b>0 432 231 824</b>	<b>0 986 430 046</b>	
		125	OM 366.965 A	02.86-05.87	6	<b>0 432 231 823</b>	<b>0 986 430 045</b>	
<b>F</b>	6,0	100	OM 366.917	06.86-07.88	6	<b>0 432 231 824</b>	<b>0 986 430 046</b>	
				08.88-02.01	6	<b>0 432 231 736</b>	<b>0 986 430 178</b>	
		125	OM 366.965 A	06.86-02.01	6	<b>0 432 231 823</b>	<b>0 986 430 045</b>	
<b>O 303</b>								
	11,0	159	OM 421.908	01.80-04.89	6	<b>0 432 231 659</b>	<b>0 986 430 095</b>	
		160-165	OM 441.908,909,911	09.87-09.92	6	<b>0 432 231 760</b>	<b>0 986 430 168</b>	
		184	OM 421.951 A	11.85-04.89	6	<b>0 432 231 814</b>	<b>0 986 430 042</b>	
		191-200	OM 441.950,953 A	12.87-09.92	6	<b>0 432 231 766</b>	<b>0 986 430 133</b>	
	14,6	206	OM 422.908	01.80-09.87	8	<b>0 432 231 680</b>	<b>0 986 430 038</b>	
		243	OM 422.951 A	08.80-09.87	8	<b>0 432 231 814</b>	<b>0 986 430 042</b>	
	15,0	213-218	OM 442...	09.87-09.92	8	<b>0 432 231 760</b>	<b>0 986 430 168</b>	
		260-269	OM 442.960,961 A	09.87-09.92	8	<b>0 432 231 766</b>	<b>0 986 430 133</b>	
<b>O 305</b>								
	11,4	147/177	OM 407.913,914,915 H; OM 407.916,917,918 H	11.76-05.87	6	<b>0 432 231 843</b>		
<b>G</b>	11,4	177	OM 407.913,919	02.78-05.87	6	<b>0 432 231 843</b>		
		206	OM 407.951,955 AH	02.79-05.87	6	<b>0 432 231 814</b>	<b>0 986 430 042</b>	
<b>O 307</b>								
	11,0	147/177	OM 407.915; OM 407.916,918	11.76-07.87	6	<b>0 432 231 843</b>		
<b>O 309</b>								
<b>D</b>	2,4	53	OM 616.937, 939	09.82-02.89 TW	4	<b>0 432 217 131</b>	<b>0 986 430 022</b>	
				01.85-02.89	4	<b>0 432 217 142</b>	<b>0 986 430 020</b>	
	3,8	63	OM 314.948; OM 314.959	01.70-02.89	4	<b>0 432 231 887</b>	<b>0 986 430 056</b>	
	5,7	96	OM 353.966	05.77-02.89	6	<b>0 432 231 887</b>	<b>0 986 430 056</b>	
<b>O 345</b>								
	6,4	205	OM 906.960 (906 LA) <Euro 3>					
			Komp.Nr. 505047/12	10.01→	TNK	6	<b>0 432 191 307</b>	
			Komp.Nr. 505047/15					
			Komp.Nr. 505047/17	10.01→	TNK	6	<b>0 432 191 302</b>	
	10,0	155	OM 489.960 (449 HLA) <Euro 2>	10.95→		5	<b>9 430 082 768</b>	
	12,0	157	OM 447.949 (447 HLA) <Euro 2>	12.96→		6	<b>0 432 131 780</b> <sup>1</sup>	
						6	<b>0 432 131 781</b>	
							<b>0 986 430 361</b>	
		184	OM 447.960 (447 HLA) <Euro 1>	05.97→		6	<b>0 432 231 676</b>	
							<b>0 986 430 360</b>	





◀ MERCEDES-BENZ

<b>G</b>	10,0	184	OM 489.961 (449 HLA) <Euro 1>	10.95→		5	<b>9 430 082 768</b>
	12,0	185-260	OM 457.942 (457 HLA) <Euro 3>				
			Komp.Nr. 505137 /03	10.01→	TNK	6	<b>0 432 191 446</b>
			Komp.Nr. 505137/05	10.01→	TNK	6	<b>0 432 191 459</b>
			Komp.Nr. 505137/06				
			Komp.Nr. 522003/03				
			Komp.Nr. 522003/02/09	10.01→	TNK	6	<b>0 432 191 263</b>
			Komp.Nr. 522003/08	10.01→	TNK	6	<b>0 432 191 258</b>
		Komp.Nr. 505137/25/26					
		Komp.Nr. 522003/18	10.01→		6	<b>0 432 193 449</b>	
<b>K</b>	12,0	220	OM 447.947 (447 HLA) <Euro 1>	05.97→		6	<b>0 432 231 676 0 986 430 360</b>
			OM 447.948 (447 HLA) <Euro 2>	05.97→		6	<b>0 432 131 781 0 986 430 361</b>
<b>O 402</b>							
	6,0	100	OM 366.917	08.88-02.01		6	<b>0 432 231 736 0 986 430 178</b>
		125	OM 366.965 A	06.86-02.01		6	<b>0 432 231 823 0 986 430 045</b>
<b>F</b>	6,0	100	OM 366.917	08.88-02.01		6	<b>0 432 231 736 0 986 430 178</b>
		125	OM 366.965 A	06.86-02.01		6	<b>0 432 231 823 0 986 430 045</b>
<b>O 404</b>							
	9,6	200/213	OM 401.970 LA <Euro 1>; OM 401.974 LA <Euro 1>	10.93-05.98		6	<b>0 432 231 665 0 986 430 205</b>
	11,0	151	OM 441.922 <Euro 1>	09.91-01.92		6	<b>0 432 231 675</b>
		213	OM 445.935 (441) LA <Euro 2>				
			Mot.Nr. →..859984	01.95-10.99		6	<b>0 432 131 800 0 986 430 264</b>
						6	<b>0 432 131 803<sup>1</sup></b>
			Mot.Nr. ..859985→	01.95-10.99		6	<b>0 432 131 728 0 986 430 327</b>
						6	<b>0 432 131 729<sup>1</sup></b>
		250	OM 441.980 LA <Euro 1>	09.91-10.99		6	<b>0 432 231 677 0 986 430 211</b>
			OM 445.934 (441) LA <Euro 2>				
			Mot.Nr. →..859979	01.95-10.99		6	<b>0 432 131 801 0 986 430 265</b>
						6	<b>0 432 131 804<sup>1</sup></b>
			Mot.Nr. ..859980→	01.95-10.99		6	<b>0 432 131 726 0 986 430 326</b>
						6	<b>0 432 131 730<sup>1</sup></b>
	12,8	280	OM 402.970 LA <Euro 1>	10.93-05.98		8	<b>0 432 231 665 0 986 430 205</b>
		280-295	OM 402.974 LA <Euro 1>	09.91-10.99		8	<b>0 432 231 717 0 986 430 205</b>
	15,0	195	OM 442.931 <Euro 1>	09.91-01.92		8	<b>0 432 231 675</b>
		213	OM 442.930	09.91-01.92		8	<b>0 432 231 661 0 986 430 168</b>
		280	OM 446.934 (442) LA <Euro 2>				
			Mot.Nr. →..860029	01.95-10.99		8	<b>0 432 131 800 0 986 430 264</b>
						8	<b>0 432 131 803<sup>1</sup></b>
			Mot.Nr. ..860030→	01.95-10.99		8	<b>0 432 131 728 0 986 430 327</b>
						8	<b>0 432 131 729<sup>1</sup></b>
			OM 446.938 (442) LA <Euro 2>				
			Mot.Nr. →..860029	01.95-10.99		8	<b>0 432 131 800 0 986 430 264</b>
						8	<b>0 432 131 803<sup>1</sup></b>
			Mot.Nr. ..860030→	01.95-10.99		8	<b>0 432 131 728 0 986 430 327</b>
						8	<b>0 432 131 729<sup>1</sup></b>
<b>O 405</b>							
	12,0	150/177	OM 447.905 h; OM 447.906,907,908 h	11.86-02.01		6	<b>0 432 231 681</b>
		157	OM 447.913 h <Euro 1>	10.93-05.98		6	<b>0 432 231 665 0 986 430 205</b>
			OM 447.970 hIA <Euro 2>	09.91-12.97	X10	6	<b>0 432 131 780<sup>1</sup></b>
					X56	6	<b>0 432 131 781 0 986 430 361</b>
			OM 447.973 hIA <Euro 2>	09.91-12.97	X10	6	<b>0 432 131 780<sup>1</sup></b>
					X56	6	<b>0 432 131 781 0 986 430 361</b>
		177	OM 427.910,911 H	11.85-12.86		6	<b>0 432 231 685</b>
		184	OM 447.956 hA <Euro 1>	10.93-02.01		6	<b>0 432 231 676 0 986 430 360</b>
			OM 447.971 hIA <Euro 2>	09.91-12.97	X10	6	<b>0 432 131 780<sup>1</sup></b>
					X56	6	<b>0 432 131 781 0 986 430 361</b>
			OM 447.974 hIA <Euro 2>	09.91-12.97	X10	6	<b>0 432 131 780<sup>1</sup></b>
					X56	6	<b>0 432 131 781 0 986 430 361</b>





	12,0	206	OM 427.950 hA OM 447.950,951 hA	01.85-12.86 11.86-02.01	6	0 432 231 663	0 986 430 093	
		220	OM 447.972 hIA <Euro 2>	09.91-12.97	X10 X56	6	0 432 131 780 <sup>1</sup> 6 0 432 131 781 0 986 430 361	
			OM 447.981 hIA <Euro 1>	10.93-12.97		6	0 432 231 676 0 986 430 360	
<b>E</b>	12,0	150	OM 427.905 h OM 447.905 h	10.84-12.86 11.86-12.91		6	0 432 231 685 6 0 432 231 681	
<b>G</b>	12,0	177	OM 427.911 h OM 447.907 h	11.85-12.86 11.86-02.01		6	0 432 231 685 6 0 432 231 681	
		184	OM 447.976 hIA <Euro 2>	09.91-12.97	X10 X56	6	0 432 131 780 <sup>1</sup> 6 0 432 131 781 0 986 430 361	
		206	OM 427.950 hA; OM 447.950 hA	01.86-02.01		6	0 432 231 663 0 986 430 093	
		220	OM 447.977 hIA <Euro 2>	09.91-12.97	X10 X56	6	0 432 131 780 <sup>1</sup> 6 0 432 131 781 0 986 430 361	
			OM 447.980 <Euro 1>	11.86-02.01		6	0 432 231 676 0 986 430 360	
<b>GN</b>	12,0	184	OM 447.978 HIA <Euro 2>	09.91-12.97	X10 X56	6	0 432 131 780 <sup>1</sup> 6 0 432 131 781 0 986 430 361	
		184/220	OM 447.959 hA <Euro 1>; OM 447.984 hIA <Euro 1>	10.93-12.97		6	0 432 231 676 0 986 430 360	
		220	OM 447.979 HIA <Euro 2>	09.91-12.97		6	0 432 131 780 <sup>1</sup> 6 0 432 131 781 0 986 430 361	
<b>GNTD</b>	12,0	220	OM 447.998 hIA <Euro 2>	09.91-12.97	X10 X56	6	0 432 131 780 <sup>1</sup> 6 0 432 131 781 0 986 430 361	
<b>GT</b>	12,0	235	OM 447.968 hIA <Euro 2>	09.91-12.97	X10 X56	6	0 432 131 780 <sup>1</sup> 6 0 432 131 781 0 986 430 361	
<b>GTD</b>	0,0	184	OM 447.955 ha <Euro 1>	11.86-02.01		6	0 432 231 676 0 986 430 360	
<b>GTZ</b>	0,0	72	OM 602.990 OM 602.994	11.86-02.01 11.86-02.01		5	0 432 217 157 0 986 430 197 6 0 432 217 157 0 986 430 197	
<b>N</b>	12,0	150/177	OM 447.910 h; OM 447.911 hIA	10.93-02.01		6	0 432 231 681	
		157	OM 447.914 h <Euro 1>	11.91-12.97		6	0 432 231 665 0 986 430 205	
		184	OM 447.996 hIA <Euro 2>	09.91-12.97	X10 X56	6	0 432 131 780 <sup>1</sup> 6 0 432 131 781 0 986 430 361	
		184/220	OM 447.957 hA <Euro 1>; OM 447.986 hIA <Euro 1>	10.93-12.97		6	0 432 231 676 0 986 430 360	
<b>N1</b>	12,0	220	OM 447.975 hIA <Euro 2>	09.91-12.97	X10 X56	6	0 432 131 780 <sup>1</sup> 6 0 432 131 781 0 986 430 361	
<b>O 407</b>								
	12,0	177	OM 447.906 h; OM 447.908 h	03.87-02.01		0	0 432 231 681	
		184	OM 447.990 HIA <Euro 2>	02.91-02.01	X10 X56	0	0 432 131 780 <sup>1</sup> 0 432 131 781 0 986 430 361	
		220	OM 447.985 HIA <Euro 1> OM 447.991 HIA <Euro 2>	02.91-02.01 02.91-02.01	X10 X56	0	0 432 231 676 0 986 430 360 0 432 131 780 <sup>1</sup> 0 432 131 781 0 986 430 361	
<b>O 408</b>								
	12,0	184	OM 447.912 h OM 447.958 hA <Euro 1>	10.93-02.01 08.92-09.93 10.93-12.01		6	0 432 231 681 6 0 432 231 701 6 0 432 231 676 0 986 430 360	
		184-220	OM 447.992,993 HIA <Euro 2>	08.92-12.01	X10 X56	6	0 432 131 780 <sup>1</sup> 6 0 432 131 781 0 986 430 361	
		220	OM 447.987 hIA <Euro 1>	08.92-09.93 10.93-12.01		6	0 432 231 701 6 0 432 231 676 0 986 430 360	
<b>OF</b>								
<b>1113</b>	6,0	125	OM 366 A	01.88-02.95 03.95-01.98		6	0 432 231 823 0 986 430 045 6 9 430 082 334	
<b>Sprinter</b>								
<b>208 D [T1N]</b>	2,3	58-60	OM 601.943	02.95-03.00		4	0 432 217 157 0 986 430 197	





◀ MERCEDES-BENZ

<b>210 D [T1N]</b>	2,9	75	OM 602.980 DE LA	01.97-03.00	FE2	5	<b>0 432 193 623</b> †			
						5	<b>0 432 193 625</b>			
						Mot.Nr. →..000136	01.97-03.00	AG	5	<b>0 432 193 557</b>
						5	<b>0 432 193 558</b> †			
						Mot.Nr. →..009849	01.97-03.00	GS	5	<b>0 432 193 557</b>
						5	<b>0 432 193 558</b> †			
						Mot.Nr. ...000137→..009698	01.97-03.00	AG	5	<b>0 432 193 758</b>
						5	<b>0 432 193 768</b> †			
Mot.Nr. ...009699→	01.97-03.00	AG,FE2	5	<b>0 432 193 637</b> †						
5	<b>0 432 193 639</b>									
Mot.Nr. ...009850→..182045	01.97-03.00	GS	5	<b>0 432 193 758</b>						
5	<b>0 432 193 768</b> †									
Mot.Nr. ...182046→	01.97-03.00	FE2,GS	5	<b>0 432 193 637</b> †						
5	<b>0 432 193 639</b>									
<b>212 D [T1N]</b>	2,9	90	OM 602.980 DE LA	02.95-03.00	FE2	5	<b>0 432 193 623</b> †			
						5	<b>0 432 193 625</b>			
						Mot.Nr. →..000136	02.95-03.00	AG	5	<b>0 432 193 557</b>
						5	<b>0 432 193 558</b> †			
						Mot.Nr. →..009849	02.95-03.00	GS	5	<b>0 432 193 557</b>
						5	<b>0 432 193 558</b> †			
						Mot.Nr. ...000137→..009698	02.95-03.00	AG	5	<b>0 432 193 758</b>
						5	<b>0 432 193 768</b> †			
Mot.Nr. ...009699→	02.95-03.00	AG,FE2	5	<b>0 432 193 637</b> †						
5	<b>0 432 193 639</b>									
Mot.Nr. ...009850→..182045	02.95-03.00	GS	5	<b>0 432 193 758</b>						
5	<b>0 432 193 768</b> †									
Mot.Nr. ...182046→	02.95-03.00	FE2,GS	5	<b>0 432 193 637</b> †						
5	<b>0 432 193 639</b>									
<b>308 D, D James Cook [T1N]</b>	2,3	58	OM 601.943	02.95-03.00		4	<b>0 432 217 157</b>	<b>0 986 430 197</b>		
<b>310 D</b>	2,5	70	OM 014 A <(632.999)>	09.96-05.01		4	<b>0 432 193 766</b>			
D, D James Cook [T1N]	2,9	75	OM 602.980 DE LA	01.97-03.00	FE2	5	<b>0 432 193 623</b> †			
						5	<b>0 432 193 625</b>			
						Mot.Nr. →..000136	01.97-03.00	AG	5	<b>0 432 193 557</b>
						5	<b>0 432 193 558</b> †			
						Mot.Nr. →..009849	01.97-03.00	GS	5	<b>0 432 193 557</b>
						5	<b>0 432 193 558</b> †			
						Mot.Nr. ...000137→..009698	01.97-03.00	AG	5	<b>0 432 193 758</b>
						5	<b>0 432 193 768</b> †			
Mot.Nr. ...009699→	01.97-03.00	AG,FE2	5	<b>0 432 193 637</b> †						
5	<b>0 432 193 639</b>									
Mot.Nr. ...009850→..182045	01.97-03.00	GS	5	<b>0 432 193 758</b>						
5	<b>0 432 193 768</b> †									
Mot.Nr. ...182046→	01.97-03.00	FE2,GS	5	<b>0 432 193 637</b> †						
5	<b>0 432 193 639</b>									
<b>312 D</b>	2,5	77	OM 014 LA <Euro 2 (632.997)>	10.99-05.01		4	<b>0 432 193 582</b>			
		85	OM 014 LA <Euro 2 (632.998)>	08.99-05.01		4	<b>0 432 193 583</b>			
D, D James Cook [T1N]	2,9	90	OM 602.980 DE LA	02.95-03.00	FE2	5	<b>0 432 193 623</b> †			
						5	<b>0 432 193 625</b>			
						Mot.Nr. →..000136	02.95-03.00	AG	5	<b>0 432 193 557</b>
						5	<b>0 432 193 558</b> †			
						Mot.Nr. →..009849	02.95-03.00	GS	5	<b>0 432 193 557</b>
						5	<b>0 432 193 558</b> †			
						Mot.Nr. ...000137→..009698	02.95-03.00	AG	5	<b>0 432 193 758</b>
						5	<b>0 432 193 768</b> †			
Mot.Nr. ...009699→	02.95-03.00	AG,FE2	5	<b>0 432 193 637</b> †						
5	<b>0 432 193 639</b>									
Mot.Nr. ...009850→..182045	02.95-03.00	GS	5	<b>0 432 193 758</b>						
5	<b>0 432 193 768</b> †									
Mot.Nr. ...182046→	02.95-03.00	FE2,GS	5	<b>0 432 193 637</b> †						
5	<b>0 432 193 639</b>									
<b>408 D [T1N]</b>	2,3	58	OM 601.943	02.95-03.00		4	<b>0 432 217 157</b>	<b>0 986 430 197</b>		







<b>410 D</b> [T1N]	2,9	75	OM 602.980 DE LA	01.97-03.00	FE2	5	<b>0 432 193 623</b> <sup>1</sup>			
						5	<b>0 432 193 625</b>			
						Mot.Nr. →..000136	01.97-03.00	AG	5	<b>0 432 193 557</b>
						5	<b>0 432 193 558</b> <sup>1</sup>			
						Mot.Nr. →..009849	01.97-03.00	GS	5	<b>0 432 193 557</b>
						5	<b>0 432 193 558</b> <sup>1</sup>			
						Mot.Nr. ..000137→..009698	01.97-03.00	AG	5	<b>0 432 193 758</b>
						5	<b>0 432 193 768</b> <sup>1</sup>			
						Mot.Nr. ..009699→	01.97-03.00	AG,FE2	5	<b>0 432 193 637</b> <sup>1</sup>
5	<b>0 432 193 639</b>									
Mot.Nr. ..009850→..182045	01.97-03.00	GS	5	<b>0 432 193 758</b>						
5	<b>0 432 193 768</b> <sup>1</sup>									
Mot.Nr. ..182046→	01.97-03.00	FE2,GS	5	<b>0 432 193 637</b> <sup>1</sup>						
5	<b>0 432 193 639</b>									
<b>412 D</b>	2,5	85	OM 014 LA <Euro 2>	10.99-05.01		4	<b>0 432 193 583</b>			
D [T1N]	2,9	90	OM 602.980 DE LA	02.95-03.00	FE2	5	<b>0 432 193 623</b> <sup>1</sup>			
						5	<b>0 432 193 625</b>			
			Mot.Nr. →..000136	02.95-03.00	AG	5	<b>0 432 193 557</b>			
						5	<b>0 432 193 558</b> <sup>1</sup>			
			Mot.Nr. →..009849	02.95-03.00	GS	5	<b>0 432 193 557</b>			
						5	<b>0 432 193 558</b> <sup>1</sup>			
			Mot.Nr. ..000137→..009698	02.95-03.00	AG	5	<b>0 432 193 758</b>			
						5	<b>0 432 193 768</b> <sup>1</sup>			
			Mot.Nr. ..009699→	02.95-03.00	AG,FE2	5	<b>0 432 193 637</b> <sup>1</sup>			
						5	<b>0 432 193 639</b>			
			Mot.Nr. ..009850→..182045	02.95-03.00	GS	5	<b>0 432 193 758</b>			
						5	<b>0 432 193 768</b> <sup>1</sup>			
			Mot.Nr. ..182046→	02.95-03.00	FE2,GS	5	<b>0 432 193 637</b> <sup>1</sup>			
						5	<b>0 432 193 639</b>			
<b>Tourino</b>										
<b>O 510</b>	6,4	180-205	OM 906... <Euro 3>							
			Mot.Typ 906.961	01.04→	TW	6	<b>0 432 191 302</b>			
						6	<b>0 432 193 438</b>			
			Mot.Typ 906.962	01.04→	TW	6	<b>0 432 191 301</b>			
						6	<b>0 432 191 394</b>			
	7,2	210	OM 926... <Euro 4/5 (BlueTec)>							
			Mot.Typ 926.949	09.06→		6	<b>0 432 193 421</b>			
<b>Tourismo</b>										
	12,0	260-300	OM 457... <Euro 4/5 (BlueTec)>							
			Mot.Typ 457.952/965	10.06→	TW	6	<b>0 432 191 219</b>			
						6	<b>0 432 193 419</b>			
<b>M, L</b>	12,0	315	OM 457... <Euro 4/5 (BlueTec)>							
			Komp.Nr. 522003/13	10.06→	TNK	6	<b>0 432 191 219</b>			
			Komp.Nr. 522003/20	10.06→	TNK	6	<b>0 432 193 419</b>			
<b>O 350</b>	11,0	250	OM 441.980 LA <Euro 1>	10.95-09.06		6	<b>0 432 231 677 0 986 430 211</b>			
			OM 445.934 LA <Euro 2>							
			Mot.Nr. →..859979	10.95-09.06		6	<b>0 432 131 801 0 986 430 265</b>			
						6	<b>0 432 131 804</b> <sup>1</sup>			
			Mot.Nr. ..859980→	10.95-09.06		6	<b>0 432 131 726 0 986 430 326</b>			
						6	<b>0 432 131 730</b> <sup>1</sup>			
	12,8	280	OM 402.970 LA <Euro 1>	10.95-09.06		8	<b>0 432 231 665 0 986 430 205</b>			
	14,6	280	OM 446.938 LA <Euro 2>							
			Mot.Nr. →..860029	10.95-09.06		8	<b>0 432 131 800 0 986 430 264</b>			
						8	<b>0 432 131 803</b> <sup>1</sup>			
			Mot.Nr. ..860030→	10.95-09.06		8	<b>0 432 131 728 0 986 430 327</b>			
						8	<b>0 432 131 729</b> <sup>1</sup>			
<b>RH</b>	12,0	260-300	OM 457... <Euro 4/5 (BlueTec)>							
			Mot.Typ 457.965	09.09→	TW	6	<b>0 432 191 219</b>			
						6	<b>0 432 193 419</b>			
<b>RH-M</b>	12,0	260-300	OM 457... <Euro 4/5 (BlueTec)>							
			Mot.Typ 457.965	09.09→	TW	6	<b>0 432 191 219</b>			
						6	<b>0 432 193 419</b>			





◀ MERCEDES-BENZ

<b>15 RHD/SHD</b>	12,0	260-310	OM 457.944 LA <Euro 3>							
			Komp.Nr. 522003/02/09	10.99-09.04	TNK	6	<b>0 432 191 263</b>			
			Komp.Nr. 522003/08	10.99-09.04	TNK	6	<b>0 432 191 258</b>			
			Komp.Nr. 505137/25/26							
			Komp.Nr. 522003/18	10.99-09.04	TNK	6	<b>0 432 193 449</b>			
		310	OM 457.944 HLA <Euro 3>							
			Komp.Nr. 522003/18	10.04-09.06	TNK	6	<b>0 432 193 449</b>			
<b>Touro</b>										
<b>OC 500</b>	12,0	260-310	OM 457.944 LA <Euro 3>							
			Komp.Nr. 522003/02/09	10.02→	TNK	6	<b>0 432 191 263</b>			
			Komp.Nr. 522003/08	10.02→		6	<b>0 432 191 258</b>			
			Komp.Nr. 505137/10							
			Komp.Nr. 522003/18	10.02→	TNK	6	<b>0 432 193 449</b>			
<b>Travego</b>										
<b>O 580</b>	12,0	315	OM 457.953 <(OM 457 LA) Euro 4>							
			Komp.Nr. 522003/13	02.06→	TNK	6	<b>0 432 191 219</b>			
			Komp.Nr. 522003/20	02.06→	TNK	6	<b>0 432 193 419</b>			
	15,9	350	OM 542.948 <(OM 502 LA)>							
			Komp.Nr. 505134/04	02.06→	TNK	8	<b>0 432 191 446</b>			
			Komp.Nr. 505137/11	02.06→	TNK	8	<b>0 432 191 384</b>			
RH(D)-15	12,0	260-310	OM 457... <Euro 3>							
			Komp.Nr. 505137/03	10.99-02.06	TNK	6	<b>0 432 191 446</b>			
			Komp.Nr. 505137/10	10.99-02.06	TNK	6	<b>0 432 191 384</b>			
			Komp.Nr. 522003/01	10.99-02.06	TNK	6	<b>0 432 191 551</b>			
			Komp.Nr. 522003/07	10.99-02.06	TNK	6	<b>0 432 191 400</b>			
RHD-17	12,0	310	OM 457.938 LA <Euro 3>							
			Komp.Nr. 505137/03	10.99-02.06	TNK	6	<b>0 432 191 446</b>			
			Komp.Nr. 505137/05	10.99-02.06	TNK	6	<b>0 432 191 459</b>			
			Komp.Nr. 505137/10	10.99-02.06	TNK	6	<b>0 432 191 384</b>			
			Komp.Nr. 522003/01	10.99-02.06	TNK	6	<b>0 432 191 551</b>			
			Komp.Nr. 522003/01	10.99-02.06	TNK	6	<b>0 432 191 400</b>			
			Komp.Nr. 522003/07							
				15,9	320-350	OM 942.900 LA <(OM 502 LA) Euro 3>				
						Komp.Nr. 505126/01/02	02.01-02.06	TNK	8	<b>0 432 191 589</b>
						Komp.Nr. 505137/01/02				
<b>15 RHD</b>	12,0	315	OM 457.961 <OM 457 LA (Euro 5)>							
			Komp.Nr. 522003/13	09.09→	TNK	6	<b>0 432 191 219</b>			
			Komp.Nr. 522003/20	09.09→	TNK	6	<b>0 432 193 419</b>			
<b>16 RHD-M</b>	12,0	315	OM 457.961 <OM 457 LA (Euro 5)>							
			Komp.Nr. 522003/13	09.09→	TNK	6	<b>0 432 191 219</b>			
			Komp.Nr. 522003/20	09.09→	TNK	6	<b>0 432 193 419</b>			
<b>17 RHD-L</b>	12,0	315	OM 457.961 <OM 457 LA (Euro 5)>							
			Komp.Nr. 522003/13	09.09→	TNK	6	<b>0 432 191 219</b>			
			Komp.Nr. 522003/20	09.09→	TNK	6	<b>0 432 193 419</b>			
<b>Unimog</b>										
<b>U 90</b>	2,9	90	OM 602.981,989 turbo <LEV>							
			Mot.Nr. →..044623	07.96-09.01	ATW	5	<b>0 432 193 768<sup>1</sup></b>			
					TW	5	<b>0 432 193 758</b>			
			Mot.Nr. ..044122→..045360	07.96-09.01	ATW	5	<b>0 432 193 623<sup>1</sup></b>			
			..044336→..044336 ..045371→							
			Mot.Nr. ..044624→..045121	07.96-09.01	ATW	5	<b>0 432 193 637<sup>1</sup></b>			
					TW	5	<b>0 432 193 639</b>			
			Mot.Nr. ..045122→..045360	07.96-09.01	TW	5	<b>0 432 193 625</b>			
			..044336→..044336 ..045371→							
90, 100L	2,9	65/71	OM 602.941 D29; OM 602.941 D29 <LEV>; OM 602.948 D29	11.92-09.97		5	<b>0 432 217 161</b>	<b>0 986 430 172</b>		





U 100 L	2,9	90	OM 602.981,989 turbo Mot.Nr. →..044623	07.96-09.01	ATW	5	<b>0 432 193 768</b> <sup>1</sup>	
					TW	5	<b>0 432 193 758</b>	
			Mot.Nr. ..044122→..045360 ..044336→..044336 ..045371→	07.96-09.01	ATW	5	<b>0 432 193 623</b> <sup>1</sup>	
			Mot.Nr. ..044624→..045121	07.96-09.01	ATW	5	<b>0 432 193 637</b> <sup>1</sup>	
					TW	5	<b>0 432 193 639</b>	
			Mot.Nr. ..045122→..045360 ..044336→..044336 ..045371→	07.96-09.01	TW	5	<b>0 432 193 625</b>	
110, 110 L	4,0	75/77	OM 364... <Euro 1>; OM 364.955 A <Euro 1>	07.92-09.95		4	<b>0 432 231 722</b>	<b>0 986 430 214</b>
130, 130 T	4,0	103	OM 354.926 LA <Euro 2>	09.95-09.98		4	<b>0 432 131 794</b>	<b>0 986 430 252</b>
130, 140, 140 L	4,0	98/100	OM 364.982 LA <Euro 1>; OM 364.985 LA <Euro 1>; OM 364.989 LA <Euro 1>	07.92-09.98		4	<b>0 432 231 688</b>	<b>0 986 430 221</b>
300	4,3	100	OM 904.927 LA <Euro3>					
			Komp.Nr. 505047/10	04.00→	TNK	4	<b>0 432 193 480</b>	
			Komp.Nr. 505047/20	04.00→	TNK	4	<b>0 432 191 394</b>	
300, 400	4,3	125	OM 904.928 LA <Euro3>					
			Komp.Nr. 505047/ 16	04.00→	TNK	4	<b>0 432 193 438</b>	
			Komp.Nr. 505047/10	04.00→	TNK	4	<b>0 432 193 480</b>	
400, 500	6,4	170	OM 906.935 LA <Euro3>	04.00→		6	<b>0 432 191 301</b>	
500	6,4	205	OM 906.955 LA <Euro3>	02.01→		6	<b>0 432 191 302</b>	
600	2,4	38	OM 616.911,915	02.88-05.88		4	<b>0 432 217 143</b>	
600 L	2,4	44	OM 616.931,932	01.85-01.88		4	<b>0 432 217 142</b>	<b>0 986 430 020</b>
				02.88-05.88		4	<b>0 432 217 143</b>	
600 T	2,4	44	OM 616.930,932	01.85-01.88		4	<b>0 432 217 142</b>	<b>0 986 430 020</b>
				02.88-05.88		4	<b>0 432 217 143</b>	
600, 650, 650 L	2,4	38/44	OM 616.942; OM 616.943	05.88-02.01		4	<b>0 432 217 143</b>	
800	3,8	55	OM 314.917	01.85-01.88		4	<b>0 432 217 142</b>	<b>0 986 430 020</b>
			Mot.Nr. →..340743	01.77-05.88		4	<b>0 432 231 887</b>	<b>0 986 430 056</b>
			Mot.Nr. ..340744→..999999	05.88-03.90		4	<b>0 432 231 887</b>	<b>0 986 430 056</b>
800 L	3,8	55	OM 314.917					
			Mot.Nr. →..340743	01.77-05.88		4	<b>0 432 231 887</b>	<b>0 986 430 056</b>
800, 800 L	3,8	55	OM 314.917					
			Mot.Nr. ..340744→	01.77-05.88		4	<b>0 432 231 824</b>	<b>0 986 430 046</b>
900	5,7	62	OM 353.902					
			Mot.Nr. →..899556	05.88-02.01		6	<b>0 432 231 887</b>	<b>0 986 430 056</b>
			Mot.Nr. ..899557→	05.88-02.01		6	<b>0 432 231 824</b>	<b>0 986 430 046</b>
		62-81	OM 353...					
			Mot.Nr. →..899556	01.77-05.88		6	<b>0 432 231 887</b>	<b>0 986 430 056</b>
			Mot.Nr. ..899557→	01.77-05.88		6	<b>0 432 231 824</b>	<b>0 986 430 046</b>
	6,0	81	OM 366.939					
			Mot.Nr. ..910817→	11.88-02.01		6	<b>0 432 231 736</b>	<b>0 986 430 178</b>
1000	5,7	70	OM 353.962	01.77-05.88		6	<b>0 432 231 887</b>	<b>0 986 430 056</b>
	6,0	75	OM 356.914 (366) <EURO 1>	09.91-12.92		6	<b>0 432 231 713</b>	<b>0 986 430 210</b>
			OM 366.915	01.88-12.92		6	<b>0 432 231 736</b>	<b>0 986 430 178</b>
1100 L	5,7	92	OM 353.907	01.77-01.88		6	<b>0 432 231 887</b>	<b>0 986 430 056</b>
1100 T, 1150, 1150 L	5,7	81	OM 353.940	05.88-02.01		6	<b>0 432 231 824</b>	<b>0 986 430 046</b>
1100, 1100 L, 1100 T	5,7	81	OM 353.940					
			Mot.Nr. →..899556	01.77-05.88		6	<b>0 432 231 887</b>	<b>0 986 430 056</b>
			Mot.Nr. ..899557→	01.77-05.88		6	<b>0 432 231 824</b>	<b>0 986 430 046</b>
1200	5,7	110	OM 353.958 Turbo	04.83-05.88		6	<b>0 432 231 870</b>	
1200 T, 1400, 1400 T, 1450	6,0	100	OM 357.912 (366) LA <Euro2>	01.92-09.96		6	<b>0 432 131 768</b>	
				01.92-04.00		6	<b>0 432 131 768</b>	
				01.92-09.01		6	<b>0 432 131 768</b>	
1200 T, 1400, 1400 T, 1450, 1600, 1650, 1650 L	6,0	100	OM 356.955 (366) A <Euro1>	01.88-09.96		6	<b>0 432 231 722</b>	<b>0 986 430 214</b>
				01.88-04.00		6	<b>0 432 231 722</b>	<b>0 986 430 214</b>
				01.88-02.01		6	<b>0 432 231 722</b>	<b>0 986 430 214</b>
				01.88-09.01		6	<b>0 432 231 722</b>	<b>0 986 430 214</b>
1200, 1200 T, 1250	5,7	92	OM 353.995 Sauglader	02.82-05.88		6	<b>0 432 231 887</b>	<b>0 986 430 056</b>
1200, 1200 T, 1250 L	6,0	92	OM 366.949 A	01.88-02.01		6	<b>0 432 231 736</b>	<b>0 986 430 178</b>





◀ MERCEDES-BENZ

U	1200, 1200 T, 1250, 1250 L, 1400 T, 1650, 1650 L	6,0	92	OM 356.954 (366) A <Euro 1>	09.91-09.96	6	0 432 231 722	0 986 430 214
					09.91-04.00	6	0 432 231 722	0 986 430 214
					09.91-01.01	6	0 432 231 722	0 986 430 214
					09.91-09.01	6	0 432 231 722	0 986 430 214
	1200, 1250, 1250 L	6,0	92	OM 356.950 (366) A <Euro 1>	01.92-09.96	6	0 432 231 824	0 986 430 046
					01.92-01.01	6	0 432 231 824	0 986 430 046
	1200, 1300 L	5,7	96	OM 353.961 Saugmotor	01.77-05.88	6	0 432 231 887	0 986 430 056
	1250	6,0	92	OM 366.949 A				
				Mot.Nr. →..910816	01.88-02.01	6	0 432 231 824	0 986 430 046
				Mot.Nr. ...910817→	01.88-02.01	6	0 432 231 736	0 986 430 178
	1250 L	6,0	100	OM 357.912 (366) LA <EURO 2>	09.91-01.01	6	0 432 131 768	
	1250 L, 1450 L	6,0	120	OM 357.913 (366) LA <EURO 2>	09.91-01.01	6	0 432 131 793	
					09.91-09.01	6	0 432 131 793	
	1250, 1250 L, 1450 L	6,0	100	OM 356.955 (366) A <Euro 1>	01.88-01.01	6	0 432 231 722	0 986 430 214
					01.88-02.01	6	0 432 231 722	0 986 430 214
					01.88-09.01	6	0 432 231 722	0 986 430 214
	1300 L	6,0	100	OM 356.955 (366) A <EURO 1>	01.92-02.01	6	0 432 231 722	0 986 430 214
				OM 366.955 A				
				Mot.Nr. ...910817→	11.86-02.01	6	0 432 231 736	0 986 430 178
			110-115	OM 366.956 A	11.86-12.87	6	0 432 231 823	0 986 430 045
				Mot.Nr. →..910816	11.86-02.01	6	0 432 231 824	0 986 430 046
	1300 L, 1550 L	6,0	110-115	OM 366.956 A				
				Mot.Nr. ...910817→	11.86-04.00	6	0 432 231 736	0 986 430 178
					11.86-02.01	6	0 432 231 736	0 986 430 178
	1350 L	6,0	100	OM 366.955 A	05.88-02.01	6	0 432 231 736	0 986 430 178
	1350 L, 1550 L	6,0	100	OM 356.955 <(366)A Euro1>	09.91-08.02	6	0 432 231 722	0 986 430 214
	1400	6,0	100	OM 366...				
				Mot.Nr. →..910816	01.88-04.00	6	0 432 231 824	0 986 430 046
				Mot.Nr. ...910817→	01.88-04.00	6	0 432 231 736	0 986 430 178
	1400, 1450, 1600	6,0	92/115	OM 356.954 A (366) <Euro1>; OM 356.956 (366)A <Euro1>	01.88-04.00	6	0 432 231 722	0 986 430 214
	1450	6,0	100	OM 366.947 A				
				Mot.Nr. →..910816	01.88-04.00	6	0 432 231 824	0 986 430 046
				Mot.Nr. ...910817→	01.88-04.00	6	0 432 231 736	0 986 430 178
	1450 L	6,0	92	OM 356.950 A (366) <Euro 1>	01.94-09.01	6	0 432 231 824	0 986 430 046
				OM 356.954 A (366) <Euro 1>	01.94-09.01	6	0 432 231 722	0 986 430 214
			92/100	OM 366.947 A (366); OM 366.949 A (366); OM 366.955 A (366)	01.94-09.01	6	0 432 231 736	0 986 430 178
			100	OM 357.912 LA (366) <Euro 2>	01.94-09.01	6	0 432 131 768	
	1500, 1500 T, 1550	5,7	110	OM 353.958	01.77-05.88	6	0 432 231 870	
	1550 L	5,7	92-96	OM 353.961,995 A <352>	02.86-05.88	6	0 432 231 870	
		6,0	100	OM 357.912 LA	05.88-04.00	6	0 432 131 768	
			115	OM 366.956 A				
				Mot.Nr. →..910816	05.88-04.00	6	0 432 231 824	0 986 430 046
				120 OM 357.913 LA	05.88-04.00	6	0 432 131 793	
				155 OM 357.924 LA <Euro 2>	05.88-04.00	6	0 432 131 794	0 986 430 252
				157 OM 356... <Euro1>	01.92-04.00	6	0 432 231 688	0 986 430 221
				177 OM 357.945 <(366)LA Euro1>	01.92-04.00	6	0 432 131 798	
	1550 L, 1650, 1650 L	6,0	114/115	OM 356.956 <Euro1>; OM 356.956 (366) A <Euro1>	01.92-04.00	6	0 432 231 722	0 986 430 214
	1550 L, 1700, 1700 T, 1750, 1750 L	6,0	125	OM 366.963 A	09.88-04.00	6	0 432 231 823	0 986 430 045
					09.88-02.01	6	0 432 231 823	0 986 430 045
	1550 L, 1750 L, 2100, 2100 L, 2150, 2150 L	6,0	150/157	OM 366.984 LA	05.88-04.00	6	0 432 231 770	
					05.88-02.01	6	0 432 231 770	
	1550 L, 2150, 2150 L, 2400, 2450	6,0	177	OM 356.980 <(366)LA Euro1>	03.90-04.00	6	0 432 231 688	0 986 430 221
					03.90-08.02	6	0 432 231 688	0 986 430 221
	1600	6,0	92-115	OM 366.947,948,949 A				
				Mot.Nr. →..910816	01.88-04.00	6	0 432 231 824	0 986 430 046
				Mot.Nr. ...910817→	01.88-04.00	6	0 432 231 736	0 986 430 178
			100	OM 357.912 LA (366) <Euro2>	11.92-09.02	6	0 432 131 768	
			115	OM 356.956 (366) A <Euro 1>	09.91-04.00	6	0 432 231 722	0 986 430 214
			132/157	OM 356.997 LA (366) <Euro1>; OM 356.998 LA (366) <Euro1>	11.92-09.02	6	0 432 231 688	0 986 430 221





<b>U</b>	1600	6,0	155	OM 357.924 (366) LA <Euro 2>	11.92-09.02	6	<b>0 432 131 794</b>	<b>0 986 430 252</b>
			177	OM 356.980 LA (366) <Euro1>	05.91-09.02			
	1600, 2400 TG	6,0	177	OM 357.945 LA (366) <Euro2>	11.92-08.02	6	<b>0 432 131 798</b>	
					11.92-09.02	6	<b>0 432 131 798</b>	
	1650, 1650 L	6,0	115	OM 366.948 A				
				Mot.Nr. →..910816	01.88-04.00	6	<b>0 432 231 824</b>	<b>0 986 430 046</b>
				Mot.Nr. ..910817→	01.88-04.00	6	<b>0 432 231 736</b>	<b>0 986 430 178</b>
	1700, 1700 L	5,7	124	OM 353.959	05.78-09.88	6	<b>0 432 231 870</b>	
	1700, 1700 T	6,0	122	OM 356.957 (366) A <Euro1>	01.92-02.01	6	<b>0 432 231 722</b>	<b>0 986 430 214</b>
					01.92-08.02	6	<b>0 432 231 722</b>	<b>0 986 430 214</b>
	1750, 1750 L	6,0	122	OM 356.957 (366) A <LEV>	01.92-08.02	6	<b>0 432 231 722</b>	<b>0 986 430 214</b>
			127	OM 356.981 (366) LA	05.91-08.02	6	<b>0 432 231 732</b>	
	1800, 1800 T, 1850, 1850 L	6,0	132	OM 356.998 (366) LA <Euro1>; OM 356.998 (366) LA <LEV>	04.92-08.02	6	<b>0 432 231 688</b>	<b>0 986 430 221</b>
	2100 T	6,0	155	OM 357.924 (366) LA <Euro2>	09.89-02.01	6	<b>0 432 131 794</b>	<b>0 986 430 252</b>
	2100, 2150, 2150 L	6,0	155	OM 357.924 <(366) LA Euro2>	05.91-08.02	6	<b>0 432 131 794</b>	<b>0 986 430 252</b>
	2150, 2150 L	6,0	157	OM 356.997 <(366) LA Euro1>	01.92-08.02	6	<b>0 432 231 688</b>	<b>0 986 430 221</b>
	2150, 2150 L, 2450	6,0	177	OM 357.945 <(366) LA Euro2>	05.91-08.02	6	<b>0 432 131 798</b>	
	3000	4,3	110	OM 904.953 LA <Euro3>	09.02→	4	<b>0 432 191 394</b>	
				Komp.Nr. 505047/20	09.02→	TNK	4	<b>0 432 191 394</b>
	4000	4,3	130	OM 904.952 LA <Euro3>	09.02→	4	<b>0 432 193 438</b>	
	4000, 5000	4,8	160	OM 924.931 <OM 924 LA (Euro 5)>; OM 924.931 <OM 924 LA Euro 5>	04.09→	4	<b>0 432 193 421</b>	
	5000	4,3	160	OM 924.916 <Euro 3>	03.03→	4	<b>0 432 191 303</b>	
		6,4	170	OM 906.935 LA <Euro 3>	03.03→	6	<b>0 432 191 301</b>	
<b>UX</b>								
<b>100</b>		2,9	80	OM 602.989 DE 29 LA <Euro 2>	08.96→	5	<b>0 432 193 758</b>	
						5	<b>0 432 193 768<sup>1</sup></b>	
<b>Vario</b>								
<b>0</b>	810 [T2W]	4,2	75	OM 904.904 LA <Euro 2>				
				Mot.Nr. →..022247	09.96-01.01	4	<b>0 432 193 480</b>	
				Mot.Nr. ..022248→	09.96-01.01	4	<b>0 432 191 526</b>	
	812 [T2W]	2,9	90	OM 602... <Euro 2>	09.96-01.01	FE2	5	<b>0 432 193 623<sup>1</sup></b>
							5	<b>0 432 193 625</b>
				Mot.Nr. →..044623	09.96-01.01		5	<b>0 432 193 758</b>
						ATW	5	<b>0 432 193 768<sup>1</sup></b>
				Mot.Nr. ..044624→	09.96-01.01		5	<b>0 432 193 637<sup>1</sup></b>
							5	<b>0 432 193 639</b>
	814 [T2W]	4,2	100	OM 904.908 LA <Euro 2>				
				Mot.Nr. →..022247	09.96-01.01	4	<b>0 432 193 480</b>	
				Mot.Nr. ..022248→	09.96-01.01	4	<b>0 432 191 526</b>	
	815 [T2W]	4,2	112	OM 904.923 LA <Euro 2>				
				Mot.Nr. →..022247	09.96-01.01	4	<b>0 432 193 480</b>	
				Mot.Nr. ..022248→	09.96-01.01	4	<b>0 432 191 526</b>	
	<b>512 D [T2W]</b>	2,9	90	OM 602.984 LA <Euro 2>	09.96-01.01	FE2	5	<b>0 432 193 623<sup>1</sup></b>
							5	<b>0 432 193 625</b>
				Mot.Nr. →..044623	09.96-01.01		5	<b>0 432 193 758</b>
						ATW	5	<b>0 432 193 768<sup>1</sup></b>
				Mot.Nr. ..044624→	09.96-01.01		5	<b>0 432 193 637<sup>1</sup></b>
							5	<b>0 432 193 639</b>
	<b>612 D [T2W]</b>	2,9	90	OM 602.984,985 LA <Euro 2>	09.96-01.01	FE2	5	<b>0 432 193 623<sup>1</sup></b>
							5	<b>0 432 193 625</b>
				Mot.Nr. →..044623	09.96-01.01		5	<b>0 432 193 758</b>
						ATW	5	<b>0 432 193 768<sup>1</sup></b>
				Mot.Nr. ..044624→	09.96-01.01		5	<b>0 432 193 637<sup>1</sup></b>
							5	<b>0 432 193 639</b>
	<b>614 D [T2W]</b>	4,2	100	OM 904.908 LA <Euro 2>				
				Mot.Nr. →..022247	09.96-01.01	4	<b>0 432 193 480</b>	
				Mot.Nr. ..022248→	09.96-01.01	4	<b>0 432 191 526</b>	
				OM 904.914 LA <Euro 3>				
				Mot.Nr. →..022247	01.01-09.06	4	<b>0 432 193 480</b>	
				Mot.Nr. ..022248→	01.01-09.06	4	<b>0 432 191 526</b>	





◀ MERCEDES-BENZ

<b>615 D [T2W]</b>	4,2	110	OM 904.936 LA <Euro 3>								
			Mot.Nr. →..022247	01.01-09.06	4	<b>0 432 193 480</b>					
				Mot.Nr. ...022248→	01.01-09.06	4	<b>0 432 191 526</b>				
		112	OM 904.923 LA <Euro 2>								
	Mot.Nr. →..022247		10.98-01.01	4	<b>0 432 193 480</b>						
			Mot.Nr. ...022248→	10.98-01.01	4	<b>0 432 191 526</b>					
<b>618 D [T2W]</b>	4,2	130	OM 904.964 LA <Euro 3>								
			Mot.Nr. →..022247	06.03-09.06	4	<b>0 432 191 396</b>					
			OM 904.964 (904 LA)								
			Mot.Nr. →..022247	09.06-03.09	4	<b>0 432 193 438</b>					
<b>810 DT [T2W]</b>	4,2	75	OM 904.904 LA <Euro 2>								
			Mot.Nr. →..022247	09.96-09.06	4	<b>0 432 193 480</b>					
			Mot.Nr. ...022248→	09.96-09.06	4	<b>0 432 191 526</b>					
<b>812 D [T2W]</b>	2,9	90	OM 602.984,985 LA <Euro 2>								
			Mot.Nr. →..044623	09.96-09.06	FE2	5	<b>0 432 193 623<sup>1</sup></b>				
							5	<b>0 432 193 625</b>			
						Mot.Nr. ...044624→	09.96-09.06	ATW	5	<b>0 432 193 758</b>	
								5	<b>0 432 193 637<sup>1</sup></b>		
						5	<b>0 432 193 639</b>				
<b>814 D [T2W]</b>	4,2	100	OM 904.908 LA <Euro 2>								
			Mot.Nr. →..022247	09.96-01.01	4	<b>0 432 193 480</b>					
				Mot.Nr. ...022248→	09.96-01.01	4	<b>0 432 191 526</b>				
				OM 904.914 LA <Euro 3>							
			Mot.Nr. →..022247	01.01-09.06	4	<b>0 432 193 480</b>					
			Mot.Nr. ...022248→	01.01-09.06	4	<b>0 432 191 526</b>					
<b>DA [T2W]</b>	4,3	100	OM 904... <Euro 2>								
			Mot.Nr. →..022247	09.96-01.01	4	<b>0 432 193 480</b>					
			Mot.Nr. ...022248→	09.96-01.01	4	<b>0 432 191 526</b>					
<b>815 D [T2W]</b>	4,2	110	OM 904.936 LA <Euro 3>								
			Mot.Nr. →..022247	01.01-09.06	4	<b>0 432 193 480</b>					
				Mot.Nr. ...022248→	01.01-09.06	4	<b>0 432 191 526</b>				
				110-112	OM 904.923,936 LA <Euro 2>						
			Mot.Nr. →..022247	09.96-01.01	4	<b>0 432 193 480</b>					
			Mot.Nr. ...022248→	09.96-01.01	4	<b>0 432 191 526</b>					
<b>DA [T2W]</b>	4,2	112	OM 904... <Euro 2>								
			Mot.Nr. →..022247	01.96-01.01	4	<b>0 432 193 480</b>					
			Mot.Nr. ...022248→	01.96-01.01	4	<b>0 432 191 526</b>					
<b>818 D [T2W]</b>	4,2	130	OM 904.964 LA <Euro 3>								
			Mot.Nr. →..022247	06.03-09.06	4	<b>0 432 191 396</b>					
<b>D/DA [T2W]</b>	4,2	130	OM 904.964 (904 LA)								
			Mot.Nr. →..022247	09.06-03.09	4	<b>0 432 193 438</b>					
<b>Vito</b>											
<b>108 D [638 TON]</b>	2,3	60	OM 601.942								
			Mot.Nr. →..518371	11.95-09.03	4	<b>0 432 217 157</b>	<b>0 986 430 197</b>				
<b>110 D [638 TON]</b>	2,3	72	OM 601.970								
			Mot.Nr. →..518371	11.95-09.03	4	<b>0 432 217 290</b>	<b>0 986 430 505</b>				
			Mot.Nr. ...518372→	11.95-09.03	4	<b>0 432 217 266</b>	<b>0 986 430 247</b>				
<b>Zetros</b>											
<b>1833</b>	7,2	240	OM 926.935 <(926 LA) Euro 3>								
			Mot.Nr. →..022247	09.08→	6	<b>0 432 191 303</b>					
			OM 926.947 <(926 LA) Euro 5>								
			Mot.Nr. →..022247	09.09→	6	<b>0 432 193 421</b>					
<b>2733</b>	7,2	240	OM 926.935 <(926 LA) Euro 3>								
			Mot.Nr. →..022247	09.08→	6	<b>0 432 191 303</b>					
			OM 926.947 <(926 LA) Euro 5>								
			Mot.Nr. →..022247	09.09→	6	<b>0 432 193 421</b>					
<b>2t</b>											
<b>207 D [T1]</b>	2,4	53	OM 616.937,939								
			Mot.Nr. →..000054	09.82-01.89	AG	4	<b>0 432 217 142</b>	<b>0 986 430 020</b>			
				Mot.Nr. →..005126	09.82-01.89	GS	4	<b>0 432 217 142</b>	<b>0 986 430 020</b>		
				Mot.Nr. ...000055→	09.82-01.89	AG	4	<b>0 432 217 131</b>	<b>0 986 430 022</b>		
			Mot.Nr. ...005127→	09.82-01.89	GS	4	<b>0 432 217 131</b>	<b>0 986 430 022</b>			
<b>208 D [T1]</b>	2,3	58-60	OM 601.940								
			Mot.Nr. →..000054	10.88-06.95	4	<b>0 432 217 161</b>	<b>0 986 430 172</b>				
<b>209 D [T1]</b>	3,0	65	OM 617.913								
			Mot.Nr. →..001875	09.82-01.89	AG	5	<b>0 432 217 142</b>	<b>0 986 430 020</b>			
				Mot.Nr. →..042201	09.82-01.89	GS	5	<b>0 432 217 142</b>	<b>0 986 430 020</b>		
				Mot.Nr. ...001876→	09.82-01.89	AG	5	<b>0 432 217 131</b>	<b>0 986 430 022</b>		
			Mot.Nr. ...042202→	09.82-01.89	GS	5	<b>0 432 217 131</b>	<b>0 986 430 022</b>			
<b>210 D [T1]</b>	2,9	70-72	OM 602.940								
			Mot.Nr. →..000054	10.88-06.95	5	<b>0 432 217 161</b>	<b>0 986 430 172</b>				





3t									
307 D [T1]	2,4	53	OM 616.937,939						
			Mot.Nr. →..000523	09.82-01.89	AG	4	0 432 217 142	0 986 430 020	
			Mot.Nr. →..051456	09.82-01.89	GS	4	0 432 217 142	0 986 430 020	
			Mot.Nr. ..000524→	09.82-01.89	AG	4	0 432 217 131	0 986 430 022	
			Mot.Nr. ..051457→	09.82-01.89	GS	4	0 432 217 131	0 986 430 022	
308 D [T1]	2,3	58-60	OM 601.940	10.88-06.95		4	0 432 217 161	0 986 430 172	
309 D [T1]	3,0	65	OM 617.913						
			Mot.Nr. →..001875	09.82-01.89	AG	5	0 432 217 142	0 986 430 020	
			Mot.Nr. →..042201	09.82-01.89	GS	5	0 432 217 142	0 986 430 020	
			Mot.Nr. ..001876→	09.82-01.89	AG	5	0 432 217 131	0 986 430 022	
			Mot.Nr. ..042202→	09.82-01.89	GS	5	0 432 217 131	0 986 430 022	
310 D [T1]	2,9	70-72	OM 602.940	10.88-06.95		5	0 432 217 161	0 986 430 172	
4t									
L 407 D	2,4	53	OM 616.910	01.85-12.88		4	0 432 217 142	0 986 430 020	
			OM 616.960	12.80-06.89		4	0 432 217 142	0 986 430 020	
407 D [T1]	2,4	53	OM 616.913,939						
			Mot.Nr. →..000054	07.81-01.89	AG	4	0 432 217 142	0 986 430 020	
			Mot.Nr. →..005126	07.81-01.89	GS	4	0 432 217 142	0 986 430 020	
			Mot.Nr. ..000055→	07.81-01.89	AG	4	0 432 217 131	0 986 430 022	
			Mot.Nr. ..005127→	07.81-01.89	GS	4	0 432 217 131	0 986 430 022	
408 D [T1]	2,3	58-60	OM 601.940	11.88-06.95		4	0 432 217 161	0 986 430 172	
409 D [T1]	3,0	65	OM 617.913						
			Mot.Nr. →..001875	04.82-01.89	AG	5	0 432 217 142	0 986 430 020	
			Mot.Nr. →..042201	04.82-01.89	GS	5	0 432 217 142	0 986 430 020	
			Mot.Nr. ..001876→	04.82-01.89	AG	5	0 432 217 131	0 986 430 022	
			Mot.Nr. ..042202→	04.82-01.89	GS	5	0 432 217 131	0 986 430 022	
410 D [T1]	2,9	70-72	OM 602.940	11.88-06.95		5	0 432 217 161	0 986 430 172	
5t									
L 508 D	3,8	60	OM 314.968	11.82-12.87		4	0 432 231 824	0 986 430 046	
DG	3,8	63	OM 314...	01.70-12.88		4	0 432 231 887	0 986 430 056	
507 D	2,4	53	OM 616.914	04.86-04.89		4	0 432 217 142	0 986 430 020	
508 D	2,3	58	OM 601.941	03.89-02.01		4	0 432 217 161	0 986 430 172	
6t									
L 608 D	3,8	60	OM 314.968	01.84-12.87		4	0 432 231 824	0 986 430 046	
		63	OM 314	06.82-01.87		4	9 430 082 311		
			OM 314...	01.70-12.88		4	0 432 231 887	0 986 430 056	
L 613 D	5,7	96	OM 353.963,966	04.77-12.88		6	0 432 231 887	0 986 430 056	
609 D	4,0	63	OM 364.919 <Euro 1>	02.92-09.01		4	0 432 231 713	0 986 430 210	
		66	OM 364.906	04.86-02.01		4	0 432 231 736	0 986 430 178	
611 D	4,0	77	OM 354.902 (364) LA <Euro 2>						
			Mot.Nr. →..379673	06.94-09.01	TW	4	0 432 131 794	0 986 430 252	
			Mot.Nr. ...379674→	06.94-09.01	TW	4	0 432 131 793		
7t									
709	4,0	66	OM 364	03.88-12.90		4	0 432 231 824	0 986 430 046	
				01.91-03.91		4	0 432 231 736	0 986 430 178	
				04.91-03.98		4	9 430 082 311		
[LK]	4,0	63	OM 364.918 <Euro 1>	02.92-12.99		4	0 432 231 713	0 986 430 210	
		66	OM 364.907	03.84-02.93		4	0 432 231 736	0 986 430 178	
D	4,0	63	OM 364.919,921 <Euro 1>	02.92-02.01		4	0 432 231 713	0 986 430 210	
		66	OM 364.906,912	04.86-02.01		4	0 432 231 736	0 986 430 178	
711 [LK]	4,0	77	OM 354.900 (364) LA <Euro 2>						
			Mot.Nr. →..379673	03.94-12.99		4	0 432 131 794	0 986 430 252	
			Mot.Nr. →..559756	03.94-12.99		4	0 432 131 793		
	4,3	90	OM 904.905 LA <Euro 2>						
			Komp.Nr. 505047/10	03.96-12.99	TNK	4	0 432 193 480		
D	4,0	77	OM 354... <Euro 2>						
			Mot.Nr. →..379673	06.94-02.01		4	0 432 131 794	0 986 430 252	
			Mot.Nr. ...379674→	06.94-02.01		4	0 432 131 793		
			OM 364.957 A <Euro 1>	02.92-02.01		4	0 432 231 722	0 986 430 214	
		85	OM 364.950,952 A	04.86-02.01		4	0 432 231 823	0 986 430 045	
714 D	4,0	103	OM 354.923,924 LA <Euro 2>	06.94-02.01		4	0 432 131 794	0 986 430 252	





◀ MERCEDES-BENZ

8t									
809 [LK]	4,0	63	OM 364.918 <Euro 1>	02.92-12.99	4	0 432 231 713	0 986 430 210		
		66	OM 364.907	03.84-02.93	4	0 432 231 736	0 986 430 178		
D, DT	4,0	63	OM 364.920 <Euro 1>; OM 364.921 <Euro 1>	02.92-02.01	4	0 432 231 713	0 986 430 210		
		66	OM 364.906; OM 364.911; OM 364.912	04.86-02.01	4	0 432 231 736	0 986 430 178		
810 D	4,0	77	OM 354.903 (364) LA <Euro 2>						
			Mot.Nr. →..379673	06.94-02.01	4	0 432 131 794	0 986 430 252		
			Mot.Nr. ...379674→	06.94-02.01	4	0 432 131 793			
811 [LK]	4,0	77	OM 354.900 (364) LA <Euro 2>						
			Mot.Nr. →..379673	03.94-12.99	4	0 432 131 794	0 986 430 252		
			Mot.Nr. →..559756	03.94-12.99	4	0 432 131 793			
	4,3	90	OM 904.905 LA <Euro 2>						
D	4,0	77	Komp.Nr. 505047/10	03.96-12.99 TNK	4	0 432 193 480			
		77	OM 364.958 A <Euro 1>	02.92-02.01	4	0 432 231 722	0 986 430 214		
		85	OM 364.950,952 A; OM 364.954 A	04.86-02.01	4	0 432 231 823	0 986 430 045		
DT	4,0	77	OM 354.901 (364) LA <Euro 2>						
			Mot.Nr. →..379673	06.94-02.01	4	0 432 131 794	0 986 430 252		
			Mot.Nr. ...379674→	06.94-02.01	4	0 432 131 793			
814 , F, KO, L, LO, O [LK]	6,0	95	OM 356.901 (366) <Euro 1>; OM 356.902 (366) <Euro 1>; OM 356.905 <Euro 1>; OM 356.906 (366) <Euro 1>; OM 356.911 <Euro 1>	02.92-12.99	6	0 432 231 713	0 986 430 210		
		100	OM 366.905; OM 366.905,906,907; OM 366.910; OM 366.932	03.84-02.93	6	0 432 231 736	0 986 430 178		
		4,3	100	OM 904.906 LA <Euro 2>	03.96-12.99	4	0 432 193 480		
, F, L, LO [LK]	4,0	103	OM 354.920 (364) LA <Euro 2>; OM 354.921 (364) LA <Euro 2>; OM 354.922 (364) LA <Euro 2>	03.94-12.99	4	0 432 131 794	0 986 430 252		
D, DA	4,0	100	OM 364.981 LA; OM 364.984 LA	11.87-02.01	4	0 432 231 770			
			OM 364.986 LA <Euro 1>; OM 364.987 LA <Euro 1>	02.92-02.01	4	0 432 231 688	0 986 430 221		
		103	OM 354.924 (364) LA <Euro 2>; OM 354.925 (364) LA <Euro 2>	06.94-02.01	4	0 432 131 794	0 986 430 252		
817 [LK]	6,0	125	OM 357.900 (366) LA <Euro 2>						
			Mot.Nr. →..406924	03.94-12.99	6	0 432 131 794	0 986 430 252		
			Mot.Nr. ...406925→	03.94-12.99	6	0 432 131 793			
		4,3	125	OM 904.907 LA <Euro 2>					
, F, L, LO [LK]	4,3		Mot.Nr. →..018751	03.96-05.97	4	0 432 191 587			
			Mot.Nr. ...018752→..022247	03.96-12.99	4	0 432 193 480			
			Mot.Nr. ...022248→	03.96-12.99	4	0 432 191 526			
, F, L, LO, O [LK]	6,0	116/121	OM 356.948 (366) A <Euro 1>; OM 356.951 (366) A <Euro 1>; OM 366.942 (366) A <Euro 1>; OM 366.943 (366) A <Euro 1>	02.92-12.99	6	0 432 231 722	0 986 430 214		
		125	OM 366.967 A; OM 366.967,973 A; OM 366.968 A; OM 366.969 A	03.84-02.93	6	0 432 231 823	0 986 430 045		
F [LK]	6,0	125	OM 357.908 (366) LA <Euro 2>						
L [LK]	6,0		Mot.Nr. →..406924	03.94-12.99	6	0 432 131 794	0 986 430 252		
			Mot.Nr. ...406925→	03.94-12.99	6	0 432 131 793			
LO [LK]	6,0	125	OM 357... <Euro 2>						
			Mot.Nr. →..406924	03.94-12.99	6	0 432 131 794	0 986 430 252		
			Mot.Nr. ...406925→	03.94-12.99	6	0 432 131 793			
			Mot.Nr. →..406924	03.94-12.99	6	0 432 131 794	0 986 430 252		
			Mot.Nr. ...406925→	03.94-12.99	6	0 432 131 793			
			Mot.Nr. →..406924	03.94-12.99	6	0 432 131 794	0 986 430 252		
			Mot.Nr. ...406925→	03.94-12.99	6	0 432 131 793			
9t									
L911 B	5,7	81/96	OM 352.906,990; OM 352.969	10.68-02.01	6	0 432 231 887	0 986 430 056		
		124	OM 353.911 A	01.72-02.01	6	0 432 231 870			
LA 911 B	5,7	81/96	OM 352.906,990; OM 352.969	10.68-02.01	6	0 432 231 887	0 986 430 056		
		124	OM 353.911 A	01.72-02.01	6	0 432 231 870			
914 , AK, Export, KO, O [LK]	6,0	100	OM 366.905,907; OM 366.905,940; OM 366.918; OM 366.930; OM 366.932	03.84-02.93	6	0 432 231 736	0 986 430 178		







914 , AK, KO [LK]	6,0	95	OM 356.901 (366) <Euro 1>; OM 356.901,911 (366) <Euro 1>; OM 356.903 (366) <Euro 1>	02.92-12.99	6	0 432 231 713	0 986 430 210
AK [LK]	6,0	125	OM 366.944,945 A Mot.Typ 366.944	02.87-02.93	6	0 432 231 823	0 986 430 045
			Mot.Typ 366.945	02.87-02.93	6	0 432 231 722	0 986 430 214
917 [LK]	6,0	125	OM 357.900 (366) LA <Euro 2> Mot.Nr. →..406924	03.94-12.99	6	0 432 131 794	0 986 430 252
			Mot.Nr. ..406925→	03.94-12.99	6	0 432 131 793	
, KO [LK]	4,3	125	OM 904.907 LA <Euro 2> Mot.Nr. →..018751	03.96-05.97	4	0 432 191 587	
			Mot.Nr. ..018752→..022247	03.96-12.99	4	0 432 193 480	
			Mot.Nr. ..022248→	03.96-12.99	4	0 432 191 526	
AF [LK]	6,0	116	OM 356... <Euro 1>	12.92-12.99	6	0 432 231 722	0 986 430 214
		125	OM 357.909,910 LA <Euro 2> Mot.Nr. →..406924	03.94-12.99	6	0 432 131 794	0 986 430 252
			Mot.Nr. ..406925→	03.94-12.99	6	0 432 131 793	
			OM 366.966 A; OM 366.974,978 A	02.87-02.93	6	0 432 231 823	0 986 430 045
AK [LK]	6,0	125	OM 357.906 (366) LA <Euro 2> Mot.Nr. →..406924	03.94-12.99	6	0 432 131 794	0 986 430 252
			Mot.Nr. ..406925→	03.94-12.99	6	0 432 131 793	
KO [LK]	6,0	125	OM 357... <Euro 2> Mot.Nr. →..406924	03.94-12.99	6	0 432 131 794	0 986 430 252
			Mot.Nr. ..406925→	03.94-12.99	6	0 432 131 793	
<b>10t</b>							
1013 A	5,7	96	OM 353.942,943 (352)	02.76-12.86	6	0 432 231 887	0 986 430 056
1017	5,7	124	OM 353... <352>	11.75-02.91 TW	6	0 432 231 870	
				08.78-02.91 TW	6	0 432 231 823	0 986 430 045
A	5,7	124	OM 353.950,952,953 A	11.75-02.91 TW	6	0 432 231 870	
				08.78-02.91 TW	6	0 432 231 823	0 986 430 045
<b>11t</b>							
L 1113	5,7	96	OM 352 OM 352 A	06.82-04.87 02.75-06.87 06.82-06.87	6 6 6	0 432 231 824 0 432 231 870 0 432 231 823	0 986 430 046  0 986 430 045
B	5,7	96	OM 352.908	10.69-02.01	6	0 432 231 887	0 986 430 056
		124	OM 353.913 A (352)	01.72-02.01	6	0 432 231 870	
L 1114	5,7	96	OM 352 OM 352 A	06.87-02.95 03.95-06.97 07.87-02.95	6 6 6	0 432 231 824 9 430 082 333 0 432 231 823	0 986 430 046  0 986 430 045
				03.95-07.97	6	9 430 082 334	
L 1117	5,7	124	OM 352 A	08.83-02.95 03.95-08.98	6 6	0 432 231 823 9 430 082 334	0 986 430 045
LA 1113 B	5,7	96	OM 352.908	10.69-02.01	6	0 432 231 887	0 986 430 056
		124	OM 353.913 A (352)	01.72-02.01	6	0 432 231 870	
LKO 1113 B	5,7	96	OM 352.908	10.69-02.01	6	0 432 231 887	0 986 430 056
O 1114 L [LK]	6,0	95	OM 356.907 (366) <Euro 1>	02.92-12.99	6	0 432 231 713	0 986 430 210
OF 1113	5,7	96	OM 352.997,998	01.75-12.92	6	0 432 231 887	0 986 430 056
1114 , A Export, Export, L [LK]	6,0	100	OM 366.907,914; OM 366.914; OM 366.930; OM 366.931; OM 366.935	03.84-02.93	6	0 432 231 736	0 986 430 178
, AK, L, O [LK]	6,0	95	OM 356.903 (366) <Euro 1>; OM 356.904 (366) <Euro 1>; OM 356.907 (366) <Euro 1>	02.92-12.99	6	0 432 231 713	0 986 430 210
AK [LK]	6,0	97-100	OM 366... Mot.Typ 356.916	02.87-02.93	6	0 432 231 713	0 986 430 210
			Mot.Typ 366.918	02.87-02.93	6	0 432 231 736	0 986 430 178
			Mot.Typ 366.935				
LO, O [LK]	6,0	100	OM 366.933	08.88-02.93	6	0 432 231 736	0 986 430 178
1117 [LK]	6,0	125	OM 357.902 (366) LA <Euro 2> Mot.Nr. →..406924	03.94-12.99	6	0 432 131 794	0 986 430 252
			Mot.Nr. ..406925→	03.94-12.99	6	0 432 131 793	
			OM 366.953,962 A	04.84-12.92	6	0 432 231 823	0 986 430 045





◀ MERCEDES-BENZ

<b>1117</b> , A, L, LO, O [LK]	6,0	116	OM 356.947 (366) A <Euro 1>; OM 356.949 (366) A <Euro 1>; OM 366.941 A <Euro 1>	02.92-12.99	6	<b>0 432 231 722</b>	<b>0 986 430 214</b>	
, L [LK]	6,0	125	OM 357.901 (366) LA <Euro 2> Mot.Nr. →..406924	03.94-12.99	6	<b>0 432 131 794</b>	<b>0 986 430 252</b>	
			Mot.Nr. ..406925→	03.94-12.99	6	<b>0 432 131 793</b>		
, L, LO [LK]	4,3	125	OM 904.907 LA <Euro 2> Mot.Nr. →..018751	03.96-05.97	4	<b>0 432 191 587</b>		
			Mot.Nr. ..018752→..022247	03.96-12.99	4	<b>0 432 193 480</b>		
			Mot.Nr. ..022248→	03.96-12.99	4	<b>0 432 191 526</b>		
A [LK]	6,0	125	OM 357.906 (366) LA <Euro 2> Mot.Nr. →..406924	03.94-12.99	6	<b>0 432 131 794</b>	<b>0 986 430 252</b>	
			Mot.Nr. ..406925→	03.94-12.99	6	<b>0 432 131 793</b>		
A, A Export, Export, L [LK]	6,0	125	OM 366.962 A; OM 366.966 A; OM 366.970 A; OM 366.975,976 A	10.84-02.93	6	<b>0 432 231 823</b>	<b>0 986 430 045</b>	
L [LK]	6,0	125	OM 357.918 (366) LA <Euro 2> Mot.Nr. →..406924	03.94-12.99	6	<b>0 432 131 794</b>	<b>0 986 430 252</b>	
			Mot.Nr. ..406925→	03.94-12.99	6	<b>0 432 131 793</b>		
LO [LK]	6,0	125	OM 357.919 (366) LA <Euro 2> Mot.Nr. →..406924	03.94-12.99	6	<b>0 432 131 794</b>	<b>0 986 430 252</b>	
			Mot.Nr. ..406925→	03.94-12.99	6	<b>0 432 131 793</b>		
LO, O [LK]	6,0	125	OM 366.971 A	04.84-02.93	6	<b>0 432 231 823</b>	<b>0 986 430 045</b>	
				04.84-12.99	6	<b>0 432 231 823</b>	<b>0 986 430 045</b>	
<b>1120</b> , L [LK]	6,0	148-150	OM 366.988 LA	06.84-02.93	6	<b>0 432 231 770</b>		
, L, LO [LK]	6,0	155	OM 357... <Euro 2>; OM 357.929 (366) LA <Euro 2>; OM 357.932 (366) LA <Euro 2>	06.94-12.99	6	<b>0 432 131 794</b>	<b>0 986 430 252</b>	
, L, LO, O [LK]	6,0	155	OM 356... <(366 LA) Euro 1>; OM 356.993 (366) LA <Euro 1>	02.92-12.99	6	<b>0 432 231 688</b>	<b>0 986 430 221</b>	
AF, F [LK]	6,0	150	OM 366.992 LA; OM 366.992,994 LA	02.87-12.92	6	<b>0 432 231 770</b>		
		155	OM 356... <Euro 1>; OM 356.996 (366) LA <Euro 1>	10.92-12.99	6	<b>0 432 231 688</b>	<b>0 986 430 221</b>	
L [LK]	6,0	125-150	OM 366.962 A	08.84-02.93	6	<b>0 432 231 823</b>	<b>0 986 430 045</b>	
LO [LK]	6,0	150	OM 366.993 LA	02.92-12.99	6	<b>0 432 231 770</b>		
<b>1124</b> AF [LK]	6,0	177	OM 356... <Euro 1>	03.92-12.99	6	<b>0 432 231 688</b>	<b>0 986 430 221</b>	
AF, F [LK]	6,0	155/177	OM 357... <Euro 2>; OM 357.933 (366) LA <Euro 2>; OM 357.942 (366) LA <Euro 2>	06.94-12.99	6	<b>0 432 131 798</b>		
F [LK]	6,0	177	OM 356... <Euro 1>	04.94-12.99	6	<b>0 432 231 688</b>	<b>0 986 430 221</b>	
<b>12t</b>								
<b>1213</b> , A, K, AK, KO, AKO, S, AS	5,7	96	OM 353...; OM 353.944,946	09.75-05.86	6	<b>0 432 231 887</b>	<b>0 986 430 056</b>	
<b>1217</b> KO [LK]	6,0	125	OM 357... <Euro 2> Mot.Nr. →..406924	03.94-12.99	6	<b>0 432 131 794</b>	<b>0 986 430 252</b>	
			Mot.Nr. ..406925→	03.94-12.99	6	<b>0 432 131 793</b>		
<b>1222</b> , A, AF	11,0	159	OM 421.905; OM 421.906	07.82-12.91	6	<b>0 432 231 680</b>	<b>0 986 430 038</b>	
, A, AF [MK]	11,0	153/160/ 165	OM 441.905,913; OM 441.914; OM 441.915; OM 441.917; OM 441.923, 925; OM 441.926; OM 441.927	07.89-08.94	6	<b>0 432 231 661</b>	<b>0 986 430 168</b>	
<b>1224</b> AF [MK]	6,0	170	OM 366.999 (366) LA <Euro 1>	02.93→	6	<b>0 432 231 688</b>	<b>0 986 430 221</b>	
		177	OM 356.999 (366) LA <Euro 1>	04.94→	6	<b>0 432 231 688</b>	<b>0 986 430 221</b>	
			OM 357.946 (366) LA <Euro 2>	01.94-09.96	6	<b>0 432 131 798</b>		
	9,6	180	OM 401.984 LA <Euro 1>	02.93-09.96	6	<b>0 432 231 717</b>	<b>0 986 430 205</b>	
F [MK]	6,0	177	OM 356.999 (366) LA <Euro 1>	02.93→	6	<b>0 432 231 688</b>	<b>0 986 430 221</b>	
<b>1226</b> AF [MK]	9,6	180/200	OM 401... <Euro 1>; OM 401.984 LA <Euro 1>	02.93-09.96	6	<b>0 432 231 717</b>	<b>0 986 430 205</b>	
	11,0	250	OM 441.989 LA <Euro 1>	02.93-05.98	6	<b>0 432 231 677</b>	<b>0 986 430 211</b>	
	15,0	195	OM 442.920,933	02.90-09.93	8	<b>0 432 231 760</b>	<b>0 986 430 168</b>	
		195/213/ 218	OM 442.907; OM 442.914,932; OM 442.926	02.90-09.93	8	<b>0 432 231 661</b>	<b>0 986 430 168</b>	
<b>1227</b> A [MK]	9,6	200	OM 401.973,989 <Euro 1>	01.92-07.92	6	<b>0 432 231 717</b>	<b>0 986 430 205</b>	





<b>1234 AF [MK]</b>	11,0	250	OM 441... <Euro 1> OM 445... <Euro 2>	01.92-09.96	6	<b>0 432 231 677</b>	<b>0 986 430 211</b>
			Mot.Nr. für Mot.BM:445.923→ ..859979	01.94-09.96	6	<b>0 432 131 801</b>	<b>0 986 430 265</b>
			Mot.Nr. für Mot.BM:445.933→ ..859984	01.94-09.96	6	<b>0 432 131 804<sup>1</sup></b>	<b>0 432 131 803<sup>1</sup></b>
			Mot.Nr. 859.985→ für Mot.BM:445.933	01.94-09.96	6	<b>0 432 131 729<sup>1</sup></b>	
			Mot.Nr. ..859980→ für M.BM: 445.923	01.94-09.96	6	<b>0 432 131 730<sup>1</sup></b>	
			Mot.Nr. ..859980→ für Mot.BM:445.923	01.94-09.96	6	<b>0 432 131 726</b>	<b>0 986 430 326</b>
			Mot.Nr. ..859985→ für Mot.BM:445.933	01.94-09.96	6	<b>0 432 131 728</b>	<b>0 986 430 327</b>
			Mot.Typ 445.933	01.94-09.96	6	<b>0 432 131 800</b>	<b>0 986 430 264</b>
			Mot.Nr. →..859984				
<b>13t</b>							
<b>L 1313</b>	5,7	96	OM 352.938,963 (352) 124 OM 353.913 A (352)	01.67-02.01 01.72-02.01	6	<b>0 432 231 887</b>	<b>0 986 430 056</b>
<b>L 1314</b>	5,7	96	OM 352	03.95-07.97	6	<b>9 430 082 333</b>	
<b>L 1319</b>	6,0	142	OM 366 LA <376.981,88, 98>	12.85-12.01	6	<b>9 430 082 291</b>	
<b>LA 1313</b>	5,7	96	OM 352.938,963 (352) 124 OM 353.913 A (352)	01.67-02.01 01.72-02.01	6	<b>0 432 231 887</b>	<b>0 986 430 056</b>
<b>LF 1313</b>	5,7	115	OM 352.968 (352)	01.67-02.01	6	<b>0 432 231 887</b>	<b>0 986 430 056</b>
<b>1314 , AK [LK]</b>	6,0	100	OM 366.907,914,938; OM 366.918,937	08.88-02.93	6	<b>0 432 231 736</b>	<b>0 986 430 178</b>
, AK, KO [LK]	6,0	95	OM 356.908 (366) <Euro 1>; OM 356.909 (366) <Euro 1>; OM 356.910 (366) <Euro 1>	12.92-12.99	6	<b>0 432 231 713</b>	<b>0 986 430 210</b>
KO [LK]	6,0	100	OM 366.936	07.84-02.93	6	<b>0 432 231 736</b>	<b>0 986 430 178</b>
<b>1317 , AK, K, L [LK]</b>	6,0	125	OM 366.944 A; OM 366.946,953,962 A; OM 366.946,962 A; OM 366.962 A; OM 366.966 A	07.84-02.93	6	<b>0 432 231 823</b>	<b>0 986 430 045</b>
, AK, L [LK]	6,0	116	OM 356.944 (366) A <Euro 1>; OM 356.945 (366) A <Euro 1>	12.92-12.99	6	<b>0 432 231 722</b>	<b>0 986 430 214</b>
, KO, L [LK]	4,3	125	OM 904.907 LA <Euro 2>				
			Mot.Nr. →..018751	03.96-05.97	4	<b>0 432 191 587</b>	
			Mot.Nr. ..018752→..022247	03.96-12.99	4	<b>0 432 193 480</b>	
			Mot.Nr. ..022248→	03.96-12.99	4	<b>0 432 191 526</b>	
	6,0	125	OM 357... <Euro 2>				
			Mot.Nr. →..406924	03.94-12.99	6	<b>0 432 131 794</b>	<b>0 986 430 252</b>
			Mot.Nr. ..406925→	03.94-12.99	6	<b>0 432 131 793</b>	
AK [LK]	6,0	125	OM 357.907 (366) LA <Euro 2>				
			Mot.Nr. →..406924	03.94-12.99	6	<b>0 432 131 794</b>	<b>0 986 430 252</b>
			Mot.Nr. ..406925→	03.94-12.99	6	<b>0 432 131 793</b>	
		155	OM 356.995 (366) LA <Euro 1>	12.92-12.99	6	<b>0 432 231 688</b>	<b>0 986 430 221</b>
<b>1320 [LK]</b>	6,0	125	OM 366.962 A	10.84-02.93	6	<b>0 432 231 823</b>	<b>0 986 430 045</b>
		148	OM 366.980 LA	10.84-02.93	6	<b>0 432 231 770</b>	
, L [LK]	6,0	148-150	OM 366...	10.84-02.93	6	<b>0 432 231 770</b>	
		155	OM 357... <Euro 2>; OM 357.932 (366) LA <Euro 2>	03.94-12.99	6	<b>0 432 131 794</b>	<b>0 986 430 252</b>
		155/177	OM 356... <(366 LA) Euro 1>; OM 356.983 (366) LA <Euro 1>; OM 356.992 (366) LA <Euro 1>	12.92-12.99	6	<b>0 432 231 688</b>	<b>0 986 430 221</b>
L [LK]	6,0	125	OM 366.962,966 A	03.85-02.93	6	<b>0 432 231 823</b>	<b>0 986 430 045</b>
<b>1324 [LK]</b>	6,0	177	OM 357... <Euro 2>				
			Mot.Typ 357.940	03.94→	6	<b>0 432 131 798</b>	
			Mot.Typ 357.948	03.94→	6	<b>0 432 131 794</b>	<b>0 986 430 252</b>
, L [LK]	6,0	170/177	OM 356.983 (366) LA <Euro 1>; OM 366.999 LA <Euro 1>	01.91-02.01	6	<b>0 432 231 688</b>	<b>0 986 430 221</b>
L [LK]	6,0	150	OM 366.997 LA <Euro 1>	01.91-02.01	6	<b>0 432 231 770</b>	
		177	OM 357.948 (366) LA <Euro 2>	03.94→	6	<b>0 432 131 794</b>	<b>0 986 430 252</b>





◀ MERCEDES-BENZ

14t									
<b>L 1414</b>	6,0	100	OM 366						
			Mot.Nr. →..088396	04.89-04.99	6	<b>0 432 231 824</b>	<b>0 986 430 046</b>		
			Mot.Nr. ...088397→	04.89-04.99	6	<b>9 430 082 311</b>			
<b>1414</b>	6,0	100	OM 366.906,909	08.88-03.91	6	<b>0 432 231 736</b>	<b>0 986 430 178</b>		
<b>1417 [MK]</b>	6,0	177	OM 357.946 (366) LA <Euro 2>	03.94-09.96	6	<b>0 432 131 798</b>			
, A [MK]	6,0	121-129	OM 356.94... <Euro 1>; OM 356.943 (366) A <Euro 1>	07.92-09.96	6	<b>0 432 231 722</b>	<b>0 986 430 214</b>		
		125	OM 357.915 (366) LA <Euro 2>	01.94→	6	<b>0 432 131 794</b>	<b>0 986 430 252</b>		
		125/129	OM 366.952 A	07.89-07.92	6	<b>0 432 231 823</b>	<b>0 986 430 045</b>		
C, CA	6,0	125	OM 366.951,952 A	04.84-03.91	6	<b>0 432 231 823</b>	<b>0 986 430 045</b>		
<b>1419 L</b>	9,6	141	OM 401.914,923	09.76-01.87	6	<b>0 432 231 873</b>	<b>0 986 430 053</b>		
<b>1420, L</b>	6,0	150	OM 366.983 LA	07.85-03.91	6	<b>0 432 231 770</b>			
, L [MK]	6,0	155	OM 356.984 (366) LA	02.90-06.93	6	<b>0 432 231 770</b>			
			OM 356.987 (366) LA <Euro 1>	08.94-09.96	6	<b>0 432 231 688</b>	<b>0 986 430 221</b>		
<b>1422 [MK]</b>	11,0	165	OM 441.923	07.89-08.94 EFV	6	<b>0 432 231 661</b>	<b>0 986 430 168</b>		
, F, L	11,0	159	OM 421.905; OM 421.906	05.82-10.90	6	<b>0 432 231 680</b>	<b>0 986 430 038</b>		
, F, LS [MK]	9,6	180/200/ 230	OM 401.973,977 LA <Euro 1>; OM 401.973, 978 LA <Euro 1>; OM 401.975 LA <Euro 1>; OM 401.979 LA <Euro 1>	02.93-08.94	6	<b>0 432 231 665</b>	<b>0 986 430 205</b>		
, L [MK]	11,0	160/165	OM 441.905	06.89-09.93	6	<b>0 432 231 661</b>	<b>0 986 430 168</b>		
				06.89-08.94	6	<b>0 432 231 661</b>	<b>0 986 430 168</b>		
F [MK]	6,0	177	OM 356.999 (366) LA	03.93-08.94	6	<b>0 432 231 688</b>	<b>0 986 430 221</b>		
	11,0	160	OM 441.925	07.89-09.93	6	<b>0 432 231 661</b>	<b>0 986 430 168</b>		
		165	OM 441.913	07.89-09.93	6	<b>0 432 231 760</b>	<b>0 986 430 168</b>		
L [MK]	11,0	160	OM 441.923	06.89-09.93	6	<b>0 432 231 661</b>	<b>0 986 430 168</b>		
<b>1424 [MK]</b>	6,0	177	OM 357.946 (366) LA <Euro 2>	01.94-09.96	6	<b>0 432 131 798</b>			
	9,6	180/200	OM 401.973 LA <Euro 1>; OM 401.975, 994 LA <Euro 1>	02.93→	6	<b>0 432 231 665</b>	<b>0 986 430 205</b>		
, F, L	12,8	176	OM 402.910,911; OM 402.919	07.75-01.87	8	<b>0 432 231 873</b>	<b>0 986 430 053</b>		
, L [MK]	11,0	180	OM 445... <Euro 2>						
			Mot.Nr. für Mot.BM:445.933→	01.95→	6	<b>0 432 131 803</b> <sup>1</sup>			
			..859984						
			Mot.Nr. →..859984	01.95→	6	<b>0 432 131 800</b>	<b>0 986 430 264</b>		
			Mot.Nr. ...859985→	01.95→	6	<b>0 432 131 728</b>	<b>0 986 430 327</b>		
					6	<b>0 432 131 729</b> <sup>1</sup>			
L [MK]	9,6	180/200	OM 401... <Euro 1>; OM 401.975 LA <Euro 1>	02.93-05.98	6	<b>0 432 231 665</b>	<b>0 986 430 205</b>		
	11,0	200	OM 445.926 (441) LA <Euro 2>						
			Mot.Nr. für Mot.BM:445.933→	01.95-09.96	6	<b>0 432 131 803</b> <sup>1</sup>			
			..859984						
			Mot.Nr. →..859984	01.95-09.96	6	<b>0 432 131 800</b>	<b>0 986 430 264</b>		
			Mot.Nr. ...859985→	01.95-09.96	6	<b>0 432 131 728</b>	<b>0 986 430 327</b>		
					6	<b>0 432 131 729</b> <sup>1</sup>			
<b>1425 LS, S</b>	14,6	184	OM 422.909	11.82-03.91	8	<b>0 432 231 680</b>	<b>0 986 430 038</b>		
<b>1426 LS [MK]</b>	15,0	195	OM 442.914,932	02.90-09.93 EFV	8	<b>0 432 231 661</b>	<b>0 986 430 168</b>		
S [MK]	15,0	191-195	OM 442.914,932	06.89-09.93	8	<b>0 432 231 661</b>	<b>0 986 430 168</b>		
<b>1427 [MK]</b>	11,0	200	OM 445.926 (441) LA <Euro 2>						
			Mot.Nr. für Mot.BM:445.933→	02.93-09.96	6	<b>0 432 131 803</b> <sup>1</sup>			
			..859984						
			Mot.Nr. →..859984	02.93-09.96	6	<b>0 432 131 800</b>	<b>0 986 430 264</b>		
			Mot.Nr. ...859985→	02.93-09.96	6	<b>0 432 131 728</b>	<b>0 986 430 327</b>		
					6	<b>0 432 131 729</b> <sup>1</sup>			
, F [MK]	9,6	200	OM 401... <Euro 1>; OM 401.973 <Euro 1>	02.93-09.96	6	<b>0 432 231 665</b>	<b>0 986 430 205</b>		
F [MK]	9,6	200	OM 445.936 (441) LA <Euro 2>						
			Mot.Nr. →..859984	01.94-09.96	6	<b>0 432 131 800</b>	<b>0 986 430 264</b>		
					6	<b>0 432 131 803</b> <sup>1</sup>			
			Mot.Nr. ...859985→	01.94-09.96	6	<b>0 432 131 728</b>	<b>0 986 430 327</b>		
					6	<b>0 432 131 729</b> <sup>1</sup>			
<b>1431 [MK]</b>	9,6	230	OM 401.979 LA <Euro 1>	02.93-08.94	6	<b>0 432 231 665</b>	<b>0 986 430 205</b>		
	15,0	218	OM 442.907	12.87-08.96	8	<b>0 432 231 661</b>	<b>0 986 430 168</b>		





<b>15t</b>								
<b>L 1513</b>	5,7	96/110	OM 352.936; OM 352.937	10.69-02.01	6	<b>0 432 231 887</b>	<b>0 986 430 056</b>	
		124	OM 353.912 A	01.72-02.01	6	<b>0 432 231 870</b>		
<b>LA 1513</b>	5,7	96/110	OM 352.936; OM 352.937	10.69-02.01	6	<b>0 432 231 887</b>	<b>0 986 430 056</b>	
		124	OM 353.912 A	01.72-02.01	6	<b>0 432 231 870</b>		
<b>LPS 1525</b>	10,0	175/186	OM 429.951 LA; OM 429.953,955 LA	01.85-12.01	5	<b>0 432 231 766</b>	<b>0 986 430 133</b>	
<b>1514 , L [LK]</b>	6,0	95	OM 356.908 (366) <Euro 1>	12.92-12.99	6	<b>0 432 231 713</b>	<b>0 986 430 210</b>	
		100	OM 366.936	02.89-12.92	6	<b>0 432 231 736</b>	<b>0 986 430 178</b>	
<b>1517 [LK]</b>	6,0	125	OM 357... <Euro 2>					
			Mot.Nr. →..406924	03.94-12.99	6	<b>0 432 131 794</b>	<b>0 986 430 252</b>	
			Mot.Nr. ..406925→	03.94-12.99	6	<b>0 432 131 793</b>		
<b>, L [LK]</b>	4,3	125	OM 904.907 LA <Euro 2>					
			Mot.Nr. →..018751	03.96-05.97	4	<b>0 432 191 587</b>		
			Mot.Nr. ..018752→..022247	03.96-12.99	4	<b>0 432 193 480</b>		
			Mot.Nr. ..022248→	03.96-12.99	4	<b>0 432 191 526</b>		
	6,0	116	OM 356... <Euro 1>; OM 356.953 (366) A <Euro 1>	12.92-12.99	6	<b>0 432 231 722</b>	<b>0 986 430 214</b>	
		125	OM 366.945,979 A; OM 366.979 A	10.88-12.92	6	<b>0 432 231 823</b>	<b>0 986 430 045</b>	
<b>L [LK]</b>	6,0	125	OM 357.962 (366) LA <Euro 2>	03.94-12.99	6	<b>0 432 131 794</b>	<b>0 986 430 252</b>	
<b>1520 , L [LK]</b>	6,0	150	OM 366.995 LA	01.89-12.92	6	<b>0 432 231 770</b>		
		155	OM 356.990 (366) LA <Euro 1>	12.92-12.99	6	<b>0 432 231 688</b>	<b>0 986 430 221</b>	
			OM 357.922 (366) LA <Euro 2>;	03.94-12.99	6	<b>0 432 131 794</b>	<b>0 986 430 252</b>	
			OM 357.930 (366) LA <Euro 2>					
<b>1524 , L [LK]</b>	6,0	170/177	OM 356.999 (366) LA <Euro 1>;	02.91-02.01	6	<b>0 432 231 688</b>	<b>0 986 430 221</b>	
			OM 366.999 LA <Euro 1>					
		177	OM 357.941 (366) LA <Euro 2>;	03.94→	6	<b>0 432 131 798</b>		
			OM 357.947 (366) LA <Euro 2>					
<b>16t</b>								
<b>1614</b>	6,0	100	OM 366.906	08.88-03.91	6	<b>0 432 231 736</b>	<b>0 986 430 178</b>	
<b>1617 C, CA, CL</b>	6,0	125	OM 366.951 A; OM 366.951,952 A;	04.84-03.91	6	<b>0 432 231 823</b>	<b>0 986 430 045</b>	
			OM 366.952 A					
<b>1619 , KO, L</b>	9,6	141	OM 401.905, 914; OM 401.914, 923	11.74-05.87	6	<b>0 432 231 873</b>	<b>0 986 430 053</b>	
<b>1620 , L</b>	6,0	150	OM 366.983 LA	07.85-03.91	6	<b>0 432 231 770</b>		
<b>1622</b>	11,0	150	OM 441.907	03.87-02.90	6	<b>0 432 231 760</b>	<b>0 986 430 168</b>	
<b>, A, L</b>	11,0	159	OM 421.905	05.82-03.91	6	<b>0 432 231 680</b>	<b>0 986 430 038</b>	
<b>, L</b>	11,0	150	OM 441.906	03.87-02.90	6	<b>0 432 231 750</b>		
				03.87-03.91	6	<b>0 432 231 750</b>		
<b>1624 [MK]</b>	9,6	180	OM 401.975 <Euro 1>	02.93-08.94	6	<b>0 432 231 665</b>	<b>0 986 430 205</b>	
	11,0	180	OM 445.924 <Euro 2>					
			Mot.Nr. →..859984	01.94-08.96	6	<b>0 432 131 800</b>	<b>0 986 430 264</b>	
					6	<b>0 432 131 803<sup>1</sup></b>		
			Mot.Nr. ..859985→	01.94-08.96	6	<b>0 432 131 728</b>	<b>0 986 430 327</b>	
					6	<b>0 432 131 729<sup>1</sup></b>		
<b>L</b>	12,8	176	OM 402.923	02.77-01.87	8	<b>0 432 231 873</b>	<b>0 986 430 053</b>	
<b>1625 , A, L</b>	14,6	184	OM 422.909	05.80-02.90	8	<b>0 432 231 680</b>	<b>0 986 430 038</b>	
<b>, L</b>	15,0	191	OM 442.905	03.87-02.90	8	<b>0 432 231 760</b>	<b>0 986 430 168</b>	
<b>1628 , L</b>	14,6	206	OM 422.905,906,911	01.80-05.89	8	<b>0 432 231 680</b>	<b>0 986 430 038</b>	
<b>L</b>	11,0	243	OM 441.951 LA	07.87-02.90	6	<b>0 432 231 766</b>	<b>0 986 430 133</b>	
<b>1633 , L</b>	14,6	243	OM 422...; OM 422.952,954 A	10.80-05.87	8	<b>0 432 231 814</b>	<b>0 986 430 042</b>	
<b>1635 , L</b>	15,0	260	OM 442.950 A; OM 442.950,952 A	02.86-07.89	8	<b>0 432 231 766</b>	<b>0 986 430 133</b>	
<b>1636 , L</b>	18,3	261	OM 423.905,908	12.83-03.91	10	<b>0 432 231 680</b>	<b>0 986 430 038</b>	
<b>1638 , LS</b>	14,6	276	OM 422...	11.80-12.86	8	<b>0 432 231 814</b>	<b>0 986 430 042</b>	
<b>1644 , LS</b>	15,0	320	OM 442... <EDC>	06.86-08.89	8	<b>0 432 231 766</b>	<b>0 986 430 133</b>	
<b>17t</b>								
<b>1717 , AK, L [MK]</b>	6,0	129	OM 366.952,356.940 A	09.89-08.94	6	<b>0 432 231 823</b>	<b>0 986 430 045</b>	
<b>1720 [LK]</b>	6,0	150	OM 366.995 LA	01.84-12.98	6	<b>0 432 231 770</b>		
<b>, L [MK]</b>	6,0	150/155	OM 356.984 (366) LA; OM 356.985 (366) LA	02.90-02.01	6	<b>0 432 231 770</b>		
<b>1722 [MK]</b>	11,0	153	OM 441.920					
			Mot.Nr. →..611690	12.88-08.94	6	<b>0 432 231 682</b>		
			Mot.Nr. ..611691→	12.88-08.94	6	<b>0 432 231 661</b>	<b>0 986 430 168</b>	
		160	OM 441.923	12.88-08.94	6	<b>0 432 231 661</b>	<b>0 986 430 168</b>	
	15,0	218	OM 442.907	12.88-08.94	8	<b>0 432 231 661</b>	<b>0 986 430 168</b>	





◀ MERCEDES-BENZ

<b>1722</b> , AK, L [MK]	11,0	151	OM 441.932 <Euro 1>; OM 441.933 <Euro 1>	12.88-08.94	6	<b>0 432 231 675</b>		
, L [MK]	11,0	153/165	OM 441.905,913,914; OM 441.905,914; OM 441.916	12.88-08.94	6	<b>0 432 231 661</b>	<b>0 986 430 168</b>	
AK [MK]	6,0	177	OM 356.999 (366) LA <Euro 1>	12.88-08.94	6	<b>0 432 231 688</b>	<b>0 986 430 221</b>	
	11,0	160	OM 441.926	02.91-08.94	EFV	6	<b>0 432 231 661</b>	<b>0 986 430 168</b>
		165	OM 441.914	02.91-08.94		6	<b>0 432 231 661</b>	<b>0 986 430 168</b>
AK, K [MK]	9,6	200/230	OM 401.973,978 LA <Euro 1>; OM 401.979 LA <Euro 1>	12.88-08.94	6	<b>0 432 231 665</b>	<b>0 986 430 205</b>	
L [MK]	6,0	150	OM 366.983 LA <Euro 1>	12.88-08.94	6	<b>0 432 231 770</b>		
	11,0	160	OM 441.923	12.88-08.94	6	<b>0 432 231 661</b>	<b>0 986 430 168</b>	
<b>1724</b> [LK]	6,0	170	OM 366.999 LA <Euro 1>	01.91-02.01	6	<b>0 432 231 688</b>	<b>0 986 430 221</b>	
<b>1726</b> [MK]	15,1	195	OM 440.909 (442)	12.88-08.94	8	<b>0 432 231 661</b>	<b>0 986 430 168</b>	
, AK, L [MK]	15,0	195/210/218	OM 442...; OM 442.906,907; OM 442.907; OM 442.909; OM 442.914, 932; OM 442.923	12.88-08.94	8	<b>0 432 231 661</b>	<b>0 986 430 168</b>	
L [MK]	11,0	250	OM 441.960 LA	12.88-08.94	6	<b>0 432 231 663</b>	<b>0 986 430 093</b>	
<b>1727</b> L [MK]	9,6	200	OM 401... <Euro 1>	12.88-08.94	6	<b>0 432 231 665</b>	<b>0 986 430 205</b>	
<b>1729</b> [MK]	15,0	218	OM 442...	12.87-08.94	8	<b>0 432 231 661</b>	<b>0 986 430 168</b>	
, AK, L [SK]	15,0	210/213/218	OM 442.906,907; OM 442.907,926; OM 442.923; OM 442.925	07.88-08.94	8	<b>0 432 231 661</b>	<b>0 986 430 168</b>	
<b>1733</b> , L [MK]	11,0	243-249	OM 441...	01.89-07.92	6	<b>0 432 231 766</b>	<b>0 986 430 133</b>	
<b>1734</b> [MK]	11,0	250	OM 441... <Euro 1>	01.91-09.96	6	<b>0 432 231 677</b>	<b>0 986 430 211</b>	
			OM 445... <(441 LA) Euro 2>					
			Mot.Nr. →.859979	01.94-08.96	6	<b>0 432 131 801</b>	<b>0 986 430 265</b>	
					6	<b>0 432 131 804</b> <sup>1</sup>		
			Mot.Nr. ...859980→	01.94-08.96	6	<b>0 432 131 726</b>	<b>0 986 430 326</b>	
					6	<b>0 432 131 730</b> <sup>1</sup>		
<b>1735</b> , AK [SK]	15,0	260-269	OM 442.942,966 A; OM 442.944,63, 64,76A	07.88-08.94	8	<b>0 432 231 663</b>	<b>0 986 430 093</b>	
K [SK]	14,6	250	OM 440.940 (442) A <Euro 1>	07.91-08.94	8	<b>0 432 231 665</b>	<b>0 986 430 205</b>	
L [SK]	15,0	218	OM 442.906	07.88-08.94	8	<b>0 432 231 661</b>	<b>0 986 430 168</b>	
		260-269	OM 442.944,963 A	07.88-09.93	8	<b>0 432 231 663</b>	<b>0 986 430 093</b>	
<b>1748</b> , L [SK]	15,0	353-362	OM 442.985,989 LA	07.88-07.92	8	<b>0 432 231 663</b>	<b>0 986 430 093</b>	
<b>18t</b>								
<b>1820</b> [MK]	6,0	155	OM 356.987 (366) LA <Euro 1>	04.94→	6	<b>0 432 231 688</b>	<b>0 986 430 221</b>	
, AK [MK]	6,0	155	OM 357.925 (366) LA <Euro 2>	01.94→	6	<b>0 432 131 794</b>	<b>0 986 430 252</b>	
, L [MK]	6,0	155	OM 356.984 (366) LA	01.91-02.01	6	<b>0 432 231 770</b>		
AK [MK]	6,0	155	OM 356.987 (366) LA <Euro 1>	07.93→	6	<b>0 432 231 688</b>	<b>0 986 430 221</b>	
L [MK]	6,0	155	OM 356.987 (366) LA <Euro 1>	04.94→	6	<b>0 432 231 688</b>	<b>0 986 430 221</b>	
<b>1824</b> [MK]	9,6	180	OM 401.975 LA <Euro 1>	08.92→	6	<b>0 432 231 717</b>	<b>0 986 430 205</b>	
	11,0	180	OM 445... <Euro 2>					
			Mot.Nr. →.859984	01.94→	6	<b>0 432 131 800</b>	<b>0 986 430 264</b>	
					6	<b>0 432 131 803</b> <sup>1</sup>		
			Mot.Nr. ...859985→	01.94→	6	<b>0 432 131 728</b>	<b>0 986 430 327</b>	
					6	<b>0 432 131 729</b> <sup>1</sup>		
		200	OM 445.926 (441) LA <Euro 2>					
			Mot.Nr. →.859984	01.94→	6	<b>0 432 131 800</b>	<b>0 986 430 264</b>	
					6	<b>0 432 131 803</b> <sup>1</sup>		
			Mot.Nr. ...859985→	01.94→	6	<b>0 432 131 728</b>	<b>0 986 430 327</b>	
					6	<b>0 432 131 729</b> <sup>1</sup>		
AK [MK]	9,6	180	OM 401.984 LA <Euro 1>	08.92→	6	<b>0 432 231 665</b>	<b>0 986 430 205</b>	
	11,0	200	OM 445.933 (441) LA <Euro 2>					
			Mot.Nr. →.859984	01.94-09.96	6	<b>0 432 131 800</b>	<b>0 986 430 264</b>	
					6	<b>0 432 131 803</b> <sup>1</sup>		
			Mot.Nr. ...859985→	01.94-09.96	6	<b>0 432 131 728</b>	<b>0 986 430 327</b>	
					6	<b>0 432 131 729</b> <sup>1</sup>		
		230	OM 445.930 (441) LA <Euro 2>					
			Mot.Nr. →.859979	01.94-09.96	6	<b>0 432 131 801</b>	<b>0 986 430 265</b>	
					6	<b>0 432 131 804</b> <sup>1</sup>		
			Mot.Nr. ...859980→	01.94-09.96	6	<b>0 432 131 726</b>	<b>0 986 430 326</b>	
					6	<b>0 432 131 730</b> <sup>1</sup>		





1824 L [MK]	9,6	180	OM 401.975 LA <Euro 1>	11.92→	6	0 432 231 665	0 986 430 205	
			OM 445... <Euro 2>					
			Mot.Nr. →..859984	01.94-09.96	6	0 432 131 800	0 986 430 264	
			Mot.Nr. ..859985→	01.94-09.96	6	0 432 131 803 <sup>1</sup>		
					6	0 432 131 728	0 986 430 327	
					6	0 432 131 729 <sup>1</sup>		
1827 [MK]	9,6	200	OM 401... <Euro 1>	10.93-05.98	6	0 432 231 665	0 986 430 205	
			OM 445... <Euro 2>					
			Mot.Nr. →..859984	01.94→	6	0 432 131 800	0 986 430 264	
	11,0	200			6	0 432 131 803 <sup>1</sup>		
			Mot.Nr. ..859985→	01.94→	6	0 432 131 728	0 986 430 327	
					6	0 432 131 729 <sup>1</sup>		
L [MK]	9,6	200	OM 401.973,77,91 LA <Euro 1>	02.91-02.01	6	0 432 231 665	0 986 430 205	
			OM 445.926,36(441)LA <Euro 2>					
			Mot.Nr. →..859984	01.94→	6	0 432 131 800	0 986 430 264	
	11,0	200			6	0 432 131 803 <sup>1</sup>		
			Mot.Nr. ..859985→	01.94→	6	0 432 131 728	0 986 430 327	
					6	0 432 131 729 <sup>1</sup>		
1831 [MK]	11,0	230	OM 445... <Euro 2>					
			Mot.Nr. →..859979	01.94→	6	0 432 131 801	0 986 430 265	
			Mot.Nr. ..859980→	01.94→	6	0 432 131 804 <sup>1</sup>		
					6	0 432 131 726	0 986 430 326	
					6	0 432 131 730 <sup>1</sup>		
	12,8	280	OM 402.987 <Euro 1>	12.90-02.01	8	0 432 231 665	0 986 430 205	
[SK]	11,0	230	OM 445... <Euro 2>					
			Mot.Nr. →..859979	01.94-08.96	6	0 432 131 801	0 986 430 265	
			Mot.Nr. ..859980→	01.94-08.96	6	0 432 131 804 <sup>1</sup>		
					6	0 432 131 726	0 986 430 326	
					6	0 432 131 730 <sup>1</sup>		
, AK, L [SK]	9,6	230	OM 401.972,79,93 LA <Euro 1>; OM 401.979,993 LA <Euro 1>; OM 401.986 LA <Euro 1>	05.91-08.96	6	0 432 231 665	0 986 430 205	
, L [MK]	9,6	230	OM 401... <Euro 1>; OM 401.972,79, 93 LA <Euro 1>	12.90-02.01	6	0 432 231 665	0 986 430 205	
AK [SK]	11,0	230	OM 445.930 (441) LA <Euro 2>					
			Mot.Nr. →..859979	01.94-08.96	6	0 432 131 801	0 986 430 265	
			Mot.Nr. ..859980→	01.94-08.96	6	0 432 131 804 <sup>1</sup>		
					6	0 432 131 726	0 986 430 326	
					6	0 432 131 730 <sup>1</sup>		
K [SK]	11,0	250	OM 441... <Euro 1>	07.92-08.96	6	0 432 231 677	0 986 430 211	
L [MK]	11,0	230	OM 445.929,37(441)LA <Euro 2>					
			Mot.Nr. →..859979	01.94→	6	0 432 131 801	0 986 430 265	
			Mot.Nr. ..859980→	01.94→	6	0 432 131 804 <sup>1</sup>		
					6	0 432 131 726	0 986 430 326	
					6	0 432 131 730 <sup>1</sup>		
L [SK]	11,0	230	OM 445.929,37(441)LA <Euro 2>					
			Mot.Nr. →..859979	01.94-08.96	6	0 432 131 801	0 986 430 265	
			Mot.Nr. ..859980→	01.94-08.96	6	0 432 131 804 <sup>1</sup>		
					6	0 432 131 726	0 986 430 326	
					6	0 432 131 730 <sup>1</sup>		
1834 , L [MK]	11,0	250	OM 441... <Euro 1>	01.91-02.01	6	0 432 231 677	0 986 430 211	
			OM 445... <(441 LA) Euro 2>					
			Mot.Nr. →..859979	01.94-02.01	6	0 432 131 801	0 986 430 265	
			Mot.Nr. ..859980→	01.94-02.01	6	0 432 131 804 <sup>1</sup>		
					6	0 432 131 726	0 986 430 326	
					6	0 432 131 730 <sup>1</sup>		
, L [SK]	11,0	250	OM 441... <Euro 1>	10.93-08.96	6	0 432 231 677	0 986 430 211	
			OM 445... <(441 LA) Euro 2>					
			Mot.Nr. →..859979	01.94-08.96	6	0 432 131 801	0 986 430 265	
			Mot.Nr. ..859980→	01.94-08.96	6	0 432 131 804 <sup>1</sup>		
					6	0 432 131 726	0 986 430 326	
					6	0 432 131 730 <sup>1</sup>		





◀ MERCEDES-BENZ

<b>1838</b> , AK, L [SK]	12,8	280	OM 402... <Euro 1>; OM 402.972, 986 LA <Euro 1>; OM 402.978,996 LA <Euro 1>	12.90-02.01	8	<b>0 432 231 665</b>	<b>0 986 430 205</b>
	14,6	320/370	OM 440.978 LA <Euro 1>; OM 440.978, 91(442)LA <Euro 1>; OM 440.982 (442) LA <Euro 1>	12.90-02.01	8	<b>0 432 231 677</b>	<b>0 986 430 211</b>
. L [SK]	14,6	280	OM 446.924,25(442)LA <Euro 2> Mot.Nr. →..860029	06.95-08.96	8	<b>0 432 131 800</b>	<b>0 986 430 264</b>
			Mot.Nr. ..860030→	06.95-08.96	8	<b>0 432 131 803<sup>1</sup></b>	
					8	<b>0 432 131 728</b>	<b>0 986 430 327</b>
					8	<b>0 432 131 729<sup>1</sup></b>	
AK [SK]	14,6	280	OM 446.927 (442) LA <Euro 2> Mot.Nr. →..860029	01.94-08.96	8	<b>0 432 131 800</b>	<b>0 986 430 264</b>
					8	<b>0 432 131 803<sup>1</sup></b>	
			Mot.Nr. ..860030→	01.94-08.96	8	<b>0 432 131 728</b>	<b>0 986 430 327</b>
					8	<b>0 432 131 729<sup>1</sup></b>	
LS [SK]	14,6	320	OM 446.943 (442) LA <Euro 2> Mot.Nr. →..860602	06.95-08.96	8	<b>0 432 131 801</b>	<b>0 986 430 265</b>
					8	<b>0 432 131 804<sup>1</sup></b>	
			Mot.Nr. ..860603→	06.95-08.96	8	<b>0 432 131 726</b>	<b>0 986 430 326</b>
					8	<b>0 432 131 730<sup>1</sup></b>	
<b>1840</b> LS [SK]	12,8	280	OM 402.971 LA <Euro 1>	07.91-07.92	8	<b>0 432 231 665</b>	<b>0 986 430 205</b>
<b>1844</b> , L [SK]	14,6	320	OM 440.970 (442) LA <Euro 1> OM 446.922 (442) LA <Euro 2> Mot.Nr. →..860602	11.91-08.96	8	<b>0 432 231 677</b>	<b>0 986 430 211</b>
				01.94-08.96	8	<b>0 432 131 801</b>	<b>0 986 430 265</b>
					8	<b>0 432 131 804<sup>1</sup></b>	
			Mot.Nr. ..860603→	01.94-08.96	8	<b>0 432 131 726</b>	<b>0 986 430 326</b>
					8	<b>0 432 131 730<sup>1</sup></b>	
<b>1850</b> [SK]	14,6	362	OM 442.985,992 LA	12.90-02.01	8	<b>0 432 231 663</b>	<b>0 986 430 093</b>
. L [SK]	14,6	370	OM 440.971,73(442)LA <Euro 1>; OM 440.973 (442) LA <Euro 1>	01.91-02.01	8	<b>0 432 231 677</b>	<b>0 986 430 211</b>
	15,0	362	OM 442...; OM 442.985,992 LA	12.90-02.01	8	<b>0 432 231 663</b>	<b>0 986 430 093</b>
		370	OM 442.997 LA <Euro 1>	01.91-02.01	8	<b>0 432 231 677</b>	<b>0 986 430 211</b>
<b>1853</b> [SK]	14,6	390	OM 446.920 (422) LA <Euro 2> Mot.Nr. →..860061	01.96-08.96	8	<b>0 432 131 802</b>	
					8	<b>0 432 131 805<sup>1</sup></b>	
			Mot.Nr. ..860062→	01.96-08.96	8	<b>0 432 131 727</b>	<b>0 986 430 325</b>
					8	<b>0 432 131 731<sup>1</sup></b>	
AK [SK]	14,6	390	OM 446.920,46(422)LA <Euro 2> Mot.Nr. →..860061	01.96-08.96	8	<b>0 432 131 802</b>	
					8	<b>0 432 131 805<sup>1</sup></b>	
			Mot.Nr. ..860062→	01.96-08.96	8	<b>0 432 131 727</b>	<b>0 986 430 325</b>
					8	<b>0 432 131 731<sup>1</sup></b>	
L [SK]	14,6	390	OM 446.920 (442) LA <Euro 2> Mot.Nr. →..860061	01.96-08.96	8	<b>0 432 131 802</b>	
					8	<b>0 432 131 805<sup>1</sup></b>	
			Mot.Nr. ..860062→	01.96-08.96	8	<b>0 432 131 727</b>	<b>0 986 430 325</b>
					8	<b>0 432 131 731<sup>1</sup></b>	
<b>19t</b>							
<b>L 1924</b>	11,6	177	OM 355.983 Mot.Nr. →..527878	05.79-02.01	6	<b>0 432 231 886</b>	
			Mot.Nr. ..527879→	07.84-02.01	6	<b>0 432 231 775</b>	
<b>L 1928</b>	11,6	206	OM 355.969 A	05.79-02.01	6	<b>0 432 231 827</b>	
<b>1922</b> , A	11,0	159	OM 421.905	10.81-03.91	6	<b>0 432 231 680</b>	<b>0 986 430 038</b>
. AK, K [SK]	11,0	160/165	OM 441.9...; OM 441.905,914; OM 441.914; OM 441.923; OM 441.926	05.89-08.94	6	<b>0 432 231 661</b>	<b>0 986 430 168</b>
<b>1926</b> [MK]	15,0	195	OM 442...	12.87-09.96	8	<b>0 432 231 661</b>	<b>0 986 430 168</b>
<b>1928</b>	15,0	206	OM 442.908	03.87-05.89	8	<b>0 432 231 760</b>	<b>0 986 430 168</b>
. A, L	14,6	206	OM 422...; OM 422.905,906,911; OM 422.905,907,913	01.80-03.91	8	<b>0 432 231 680</b>	<b>0 986 430 038</b>
<b>1929</b> [SK]	15,0	210	OM 442.908,923	07.88-08.94	8	<b>0 432 231 680</b>	<b>0 986 430 038</b>
. A, L [SK]	15,0	210/213/ 218	OM 442.906; OM 442.906,907; OM 442.909,924; OM 442.925; OM 442.926,929	07.88-08.94	8	<b>0 432 231 661</b>	<b>0 986 430 168</b>







1929 A [SK]	15,0	269	OM 442.971 A	07.88-09.93	8	0 432 231 663	0 986 430 093
	18,3	340	OM 443.940 A	07.88-08.94	10	0 432 231 663	0 986 430 093
K [SK]	15,0	269	OM 442.966 A	07.88-08.94	8	0 432 231 663	0 986 430 093
1933 , L	14,6	243	OM 422...; OM 422.954 A	11.80-03.91	8	0 432 231 684	0 986 430 042
1935 , A, AK, K [SK]	15,0	269/362	OM 442.942,966 A; OM 442.943,944, 963 A; OM 442.964 A; OM 442.971, 972 A; OM 442.976 A; OM 442.989 LA	05.89-08.94	8	0 432 231 663	0 986 430 093
, A, LS	15,0	260-269	OM 442.950,952 A; OM 442.962 A	02.86-03.91	8	0 432 231 766	0 986 430 133
, AK [SK]	15,0	370	OM 442.997 LA <Euro 1>	05.89-08.94	8	0 432 231 677	0 986 430 211
A [SK]	15,0	250	OM 442.978 A <Euro 1>	05.89-08.94	8	0 432 231 665	0 986 430 205
AK [SK]	14,6	370	OM 440.971 (442) LA <Euro 1>	01.91-10.93	8	0 432 231 677	0 986 430 211
AK, K [SK]	14,6	250	OM 440... <Euro 1>; OM 440.940 (442) A <Euro 1>	07.91-08.94	8	0 432 231 665	0 986 430 205
K [SK]	15,0	250	OM 442.977 A <Euro 1>	07.91-08.94	8	0 432 231 665	0 986 430 205
1936 , A	18,3	261	OM 423.905,906,907; OM 423.905,906,908	10.81-03.91	10	0 432 231 680	0 986 430 038
A	18,3	331	OM 443.940 A	01.90-03.91	10	0 432 231 766	0 986 430 133
1938	14,6	276	OM 422...	11.80-06.90	8	0 432 231 684	0 986 430 042
1944 , LS	15,0	320	OM 442.951 LA	10.85-12.89	8	0 432 231 766	0 986 430 133
1948 [SK]	15,0	353-362	OM 442...	09.88-07.92	8	0 432 231 663	0 986 430 093
<b>20t</b>							
2020 [LK]	6,0	150	OM 366.995 LA	01.84-12.98	6	0 432 231 770	
2024 [SK]	11,0	180	OM 445.924 (441) LA <Euro 2>				
			Mot.Nr. →..859984	01.94-08.96	6	0 432 131 800	0 986 430 264
					6	0 432 131 803 <sup>1</sup>	
			Mot.Nr. ..859985→	01.94-08.96	6	0 432 131 728	0 986 430 327
					6	0 432 131 729 <sup>1</sup>	
, A [SK]	9,6	180	OM 401.975 LA <Euro 1>; OM 401.984 LA <Euro 1>	02.93-08.96	6	0 432 231 665	0 986 430 205
A [SK]	11,0	180	OM 445.925 (441) LA <Euro 2>				
			Mot.Nr. →..859984	01.94-08.96	6	0 432 131 800	0 986 430 264
					6	0 432 131 803 <sup>1</sup>	
			Mot.Nr. ..859985→	01.94-08.96	6	0 432 131 728	0 986 430 327
					6	0 432 131 729 <sup>1</sup>	
L [LK]	6,0	177	OM 357... <(366 LA) Euro 2>	03.94-02.01	6	0 432 131 798	
2025 S	14,6	184	OM 422.909	08.83-03.91	8	0 432 231 680	0 986 430 038
2027 AK [SK]	9,6	200	OM 401.989	02.93-08.96	6	0 432 231 665	0 986 430 205
	11,0	200	OM 445.933 (441) LA <Euro 2>				
			Mot.Nr. →..859984	01.94-09.96	6	0 432 131 800	0 986 430 264
					6	0 432 131 803 <sup>1</sup>	
			Mot.Nr. ..859985→	01.94-09.96	6	0 432 131 728	0 986 430 327
					6	0 432 131 729 <sup>1</sup>	
2028 LS	14,6	206	OM 422.905,910,911	01.80-06.89	8	0 432 231 680	0 986 430 038
2031 [SK]	11,0	230	OM 441.998 LA <Euro 1>	03.92-08.96	6	0 432 231 665	0 986 430 205
			OM 445.929 (441) LA <Euro 2>				
			Mot.Nr. →..859979	01.94-09.96	6	0 432 131 801	0 986 430 265
					6	0 432 131 804 <sup>1</sup>	
			Mot.Nr. ..859980→	01.94-09.96	6	0 432 131 726	0 986 430 326
					6	0 432 131 730 <sup>1</sup>	
, A [SK]	9,6	230	OM 401... <Euro 1>; OM 401.986 LA <Euro 1>	03.92-09.96	6	0 432 231 665	0 986 430 205
A [SK]	11,0	230	OM 445.930 (441) LA <Euro 2>				
			Mot.Nr. →..859979	01.94-08.96	6	0 432 131 801	0 986 430 265
					6	0 432 131 804 <sup>1</sup>	
			Mot.Nr. ..859980→	01.94-08.96	6	0 432 131 726	0 986 430 326
					6	0 432 131 730 <sup>1</sup>	
	12,8	280	OM 402.978,996 LA <Euro 1>	03.92-08.96	8	0 432 231 665	0 986 430 205
	14,6	280	OM 446.927 (441) LA <Euro 2>				
			Mot.Nr. →..860029	01.94-08.96	8	0 432 131 800	0 986 430 264
					8	0 432 131 803 <sup>1</sup>	
			Mot.Nr. ..860030→	01.94-08.96	8	0 432 131 728	0 986 430 327
					8	0 432 131 729 <sup>1</sup>	
2033 LS	14,6	243	OM 422.952,956 A	12.81-05.87	8	0 432 231 684	0 986 430 042





◀ MERCEDES-BENZ

2035 LS, S	15,0	260	OM 442.950,952,958 A	06.86-07.89	8	0 432 231 766	0 986 430 133
2036 LS	18,3	261	OM 423.905,908	03.84-03.91	10	0 432 231 680	0 986 430 038
2038 [SK]	14,6	280	OM 440.990 (442) LA <Euro 1>	11.91-08.96	8	0 432 231 665	0 986 430 205
			OM 446... <Euro 2>				
			Mot.Nr. →..860029	01.94-08.96	8	0 432 131 800	0 986 430 264
					8	0 432 131 803 <sup>1</sup>	
			Mot.Nr. ...860030→	01.94-08.96	8	0 432 131 728	0 986 430 327
					8	0 432 131 729 <sup>1</sup>	
, AS [SK]	12,8	280	OM 402.971,985 LA <Euro 1>; OM 402.972,986 LA <Euro 1>; OM 402.978 LA <Euro 1>	11.91-08.96	8	0 432 231 665	0 986 430 205
AS [SK]	14,6	280	OM 446.927 (442) LA <Euro 2>				
			Mot.Nr. →..860029	01.94-08.96	8	0 432 131 800	0 986 430 264
					8	0 432 131 803 <sup>1</sup>	
			Mot.Nr. ...860030→	01.94-08.96	8	0 432 131 728	0 986 430 327
					8	0 432 131 729 <sup>1</sup>	
2044 [SK]	14,6	320	OM 446.. <Euro 2>				
			Mot.Nr. →..860602	01.94-08.96	8	0 432 131 801	0 986 430 265
					8	0 432 131 804 <sup>1</sup>	
			Mot.Nr. ...860603→	01.94-08.96	8	0 432 131 726	0 986 430 326
					8	0 432 131 730 <sup>1</sup>	
2050 [SK]	14,6	390	OM 446.920 (422) LA <Euro 2>				
			Mot.Nr. →..860061	01.96-08.96	8	0 432 131 802	
					8	0 432 131 805 <sup>1</sup>	
			Mot.Nr. ...860062→	01.96-08.96	8	0 432 131 727	0 986 430 325
					8	0 432 131 731 <sup>1</sup>	
	15,0	362	OM 442...	01.91-02.01	8	0 432 231 663	0 986 430 093
		370	OM 442.997 LA <Euro 1>	01.91-02.01	8	0 432 231 677	0 986 430 211
S [SK]	14,6	370	OM 440.976 (422) LA <Euro 1>	01.91-02.01	8	0 432 231 677	0 986 430 211
2055 [SK]	15,0	370	OM 442.997 LA <Euro 1>	01.91-02.01	8	0 432 231 677	0 986 430 211
<b>22t</b>							
2219 A, K, KO, L	9,6	141	OM 401.905, 914; OM 401.914; OM 401.923; OM 401.925	06.76-06.87	6	0 432 231 873	0 986 430 053
2220, L	6,0	150	OM 366.983 LA	07.85-03.91	6	0 432 231 770	
2222, B, L	11,0	159	OM 421.905; OM 421.905,907	05.82-03.91	6	0 432 231 680	0 986 430 038
B	11,0	150	OM 441.906	03.87-03.91	6	0 432 231 750	
2225, B	14,6	184	OM 422.909; OM 422.912	08.83-03.91	8	0 432 231 680	0 986 430 038
B	15,0	191	OM 442.905	03.87-03.91	8	0 432 231 760	0 986 430 168
2228, L	14,6	206	OM 422.905,906,911; OM 422.905,911	12.79-03.91	8	0 432 231 680	0 986 430 038
2233, L	14,6	243	OM 422.952 A; OM 422.952,954 A	11.80-05.87	8	0 432 231 684	0 986 430 042
2235, L	15,0	260	OM 442.950 A	03.86-07.89	8	0 432 231 766	0 986 430 133
2236	18,3	261	OM 423.905,908	09.82-03.91	10	0 432 231 680	0 986 430 038
2238	14,6	276	OM 422...	01.81-12.86	8	0 432 231 684	0 986 430 042
L	14,6	276	OM 422.955,959 LA	02.83-12.86	8	0 432 231 684	0 986 430 042
					8	0 432 231 814	0 986 430 042
2244, L	15,0	320	OM 442.951 LA	10.85-07.89	8	0 432 231 766	0 986 430 133
<b>23t</b>							
2320 [MK]	6,0	155	OM 356.987 (366) LA <Euro 1>	08.94-09.96	6	0 432 231 688	0 986 430 221
2327 [MK]	9,6	200	OM 401.973 <Euro 1>	02.93-09.96	6	0 432 231 665	0 986 430 205
	11,0	200	OM 445.926 (441) LA <Euro 2>				
			Mot.Nr. →..859984	01.94-09.96	6	0 432 131 800	0 986 430 264
					6	0 432 131 803 <sup>1</sup>	
			Mot.Nr. ...859985→	01.94-09.96	6	0 432 131 728	0 986 430 327
					6	0 432 131 729 <sup>1</sup>	
<b>24t</b>							
2420, L [MK]	6,0	155	OM 356.984 (366) LA	02.90-08.94	6	0 432 231 770	
2422	11,0	159	OM 421.905	05.86-06.89	6	0 432 231 680	0 986 430 038
, L [MK]	11,0	165	OM 441.905; OM 441.905,912	09.89-08.94	6	0 432 231 760	0 986 430 168
2425	14,6	184	OM 422.909	09.85-06.89	8	0 432 231 680	0 986 430 038
2426, L [MK]	15,0	195	OM 442...; OM 442.914,932	01.90-08.94	8	0 432 231 760	0 986 430 168
2427 L [MK]	9,6	200	OM 401.973 LA <Euro 1>	07.92-09.96	6	0 432 231 665	0 986 430 205
2429, L [SK]	15,0	210/213/ 218	OM 442.906; OM 442.906,907; OM 442.923; OM 442.925	07.88-08.94	8	0 432 231 661	0 986 430 168





2431 [MK]	9,6	230	OM 401... <Euro 1>	12.87-09.96	6	0 432 231 665	0 986 430 205
2433	14,6	243	OM 422.954,957	12.82-11.91	8	0 432 231 684	0 986 430 042
, L [MK]	11,0	243-249	OM 441...; OM 441.960,981 LA	05.89-07.92	6	0 432 231 766	0 986 430 133
2434 [MK]	11,0	250	OM 441... <Euro 1>	01.91-09.96	6	0 432 231 677	0 986 430 211
			OM 445... <(441 LA) Euro 2>				
			Mot.Nr. →..859979	01.94-08.96	6	0 432 131 801	0 986 430 265
					6	0 432 131 804 <sup>1</sup>	
			Mot.Nr. ..859980→	01.94-08.96	6	0 432 131 726	0 986 430 326
					6	0 432 131 730 <sup>1</sup>	
[SK]	11,0	250	OM 441... <Euro 1>	01.91-09.96	6	0 432 231 677	0 986 430 211
2435 , L [SK]	15,0	260-269	OM 442.943,944 A; OM 442.963,964, 965 A; OM 442.963-965,968 A; OM 442.976 A	07.88-08.94	8	0 432 231 663	0 986 430 093
K [SK]	14,6	250	OM 440.940 (442) A <Euro 1>	07.91-08.94	8	0 432 231 665	0 986 430 205
2438	14,6	276	OM 422.953,955,959LA	01.81-12.86	8	0 432 231 684	0 986 430 042
2444	14,6	320	OM 442...	10.85-08.96	8	0 432 231 766	0 986 430 133
2448 , L [SK]	15,0	353-362	OM 442...; OM 442.985,989 LA	07.88-07.92	8	0 432 231 663	0 986 430 093
<b>25t</b>							
2524 , L [MK]	9,6	180	OM 401.975 LA <Euro 1>	06.92→	6	0 432 231 665	0 986 430 205
2527 B, L [MK]	9,6	200	OM 401... <Euro 1>; OM 401.973,977 LA <Euro 1>	03.91→	6	0 432 231 665	0 986 430 205
2528 A	14,6	206	OM 422.907,913	01.86-12.92	8	0 432 231 680	0 986 430 038
2531 [SK]	9,6	230	OM 401... <Euro 1>	03.91-09.96	6	0 432 231 665	0 986 430 205
	11,0	230	OM 445... <(441 LA) Euro 2>				
			Mot.Nr. →..859979	01.94-09.96	6	0 432 131 801	0 986 430 265
					6	0 432 131 804 <sup>1</sup>	
			Mot.Nr. ..859980→	01.94-09.96	6	0 432 131 726	0 986 430 326
					6	0 432 131 730 <sup>1</sup>	
, L [MK]	9,6	230	OM 401... <Euro 1>	12.90→	6	0 432 231 665	0 986 430 205
2534 , L [MK]	11,0	250	OM 441... <Euro 1>; OM 441.986 LA <Euro 1>	01.91-02.01	6	0 432 231 677	0 986 430 211
2536 A	18,3	261	OM 423.907	01.86-12.92	10	0 432 231 680	0 986 430 038
2538 [SK]	14,6	280	OM 446.928 (442) LA <Euro 2>				
			Mot.Nr. →..860029	01.94-08.96	8	0 432 131 800	0 986 430 264
					8	0 432 131 803 <sup>1</sup>	
			Mot.Nr. ..860030→	01.94-08.96	8	0 432 131 728	0 986 430 327
					8	0 432 131 729 <sup>1</sup>	
	15,0	370	OM 442.997 (442) LA <Euro 1>	03.91-08.96	8	0 432 231 677	0 986 430 211
, L [SK]	12,8	280	OM 402.971,972,975LA <Euro 1>; OM 402.985,986 LA <Euro 1>; OM 402.985,986,989LA <Euro 1>; OM 402.989,990 LA <Euro 1>	03.91-08.96	8	0 432 231 665	0 986 430 205
	14,6	280	OM 446.. <Euro 2>				
			Mot.Nr. →..860029	01.94-08.96	8	0 432 131 800	0 986 430 264
					8	0 432 131 803 <sup>1</sup>	
			Mot.Nr. ..860030→	01.94-08.96	8	0 432 131 728	0 986 430 327
					8	0 432 131 729 <sup>1</sup>	
		320/370	OM 440... <Euro 1>	03.91-08.96	8	0 432 231 677	0 986 430 211
K [SK]	15,0	362	OM 442.989 (442) LA <Euro 1>	03.91-08.96	8	0 432 231 663	0 986 430 093
L [SK]	14,6	280	OM 446... <Euro 2>				
			Mot.Nr. →..860029	01.94-08.96	8	0 432 131 800	0 986 430 264
					8	0 432 131 803 <sup>1</sup>	
			Mot.Nr. ..860030→	01.94-08.96	8	0 432 131 728	0 986 430 327
					8	0 432 131 729 <sup>1</sup>	
		320	OM 446... <Euro 2>				
			Mot.Nr. →..860602	01.94-08.96	8	0 432 131 801	0 986 430 265
					8	0 432 131 804 <sup>1</sup>	
			Mot.Nr. ..860603→	01.94-08.96	8	0 432 131 726	0 986 430 326
					8	0 432 131 730 <sup>1</sup>	





◀ MERCEDES-BENZ

<b>2544</b> , L [SK]	14,6	320	OM 440... <(442 LA) Euro 1> OM 446.922 (442) LA <Euro 2> Mot.Nr. →..860602	01.92-08.96	8	<b>0 432 231 677</b>	<b>0 986 430 211</b>
			Mot.Nr. ...860603→	01.94-08.96	8	<b>0 432 131 801</b>	<b>0 986 430 265</b>
					8	<b>0 432 131 804</b> †	
					8	<b>0 432 131 726</b>	<b>0 986 430 326</b>
					8	<b>0 432 131 730</b> †	
<b>2550</b> [SK]	15,0	370	OM 442.997 LA <Euro 1>; OM 442.997, 998 LA <Euro 1>	01.91-08.96	8	<b>0 432 231 677</b>	<b>0 986 430 211</b>
, L [SK]	14,6	370	OM 440... <Euro 1>; OM 440.973 (442) LA <Euro 1>	01.91-08.96	8	<b>0 432 231 677</b>	<b>0 986 430 211</b>
		390	OM 446.920 (442) LA <Euro 2> Mot.Nr. →..860061	01.94-08.96	8	<b>0 432 131 802</b>	
					8	<b>0 432 131 805</b> †	
			Mot.Nr. ...860062→	01.94-08.96	8	<b>0 432 131 727</b>	<b>0 986 430 325</b>
					8	<b>0 432 131 731</b> †	
<b>2553</b> , L [SK]	14,6	390	OM 446.920 LA <Euro 2> Mot.Nr. →..860061	01.96-08.96	8	<b>0 432 131 802</b>	
					8	<b>0 432 131 805</b> †	
			Mot.Nr. ...860062→	01.96-08.96	8	<b>0 432 131 727</b>	<b>0 986 430 325</b>
					8	<b>0 432 131 731</b> †	
<b>26t</b>							
<b>L 2624</b>	11,6	177	OM 355.983,984 Mot.Nr. →..527878	01.78-02.01	6	<b>0 432 231 886</b>	
			Mot.Nr. ...527879→	01.78-02.01	6	<b>0 432 231 775</b>	
<b>L 2628</b>	11,6	206	OM 355.969 A	11.78-02.01	6	<b>0 432 231 827</b>	
<b>2628</b>	18,3	331	OM 443.940 A	01.90-03.91	10	<b>0 432 231 766</b>	<b>0 986 430 133</b>
, A, B	14,6	206	OM 422.905,911; OM 422.907,913	02.80-03.91	8	<b>0 432 231 680</b>	<b>0 986 430 038</b>
<b>2629</b> , A [SK]	15,0	213/218	OM 442.906,907,917; OM 442.926	07.88-08.94	8	<b>0 432 231 760</b>	<b>0 986 430 168</b>
<b>2631</b> [SK]	11,0	230	OM 441.998 LA <Euro 1>	06.92-08.96	6	<b>0 432 231 665</b>	<b>0 986 430 205</b>
, A [SK]	9,6	230	OM 401.972,981 LA <Euro 1>; OM 401.986 LA <Euro 1>	06.92-08.96	6	<b>0 432 231 665</b>	<b>0 986 430 205</b>
<b>2633</b>	14,6	243	OM 422.952,954 A; OM 422.957	05.82-05.87	8	<b>0 432 231 684</b>	<b>0 986 430 042</b>
<b>2635</b> [SK]	14,6	250	OM 440.940 (442) A <Euro 1>	07.91-08.94	8	<b>0 432 231 665</b>	<b>0 986 430 205</b>
, A	15,0	260/269	OM 442.950,952 A; OM 442.962 A	04.86-03.91	8	<b>0 432 231 766</b>	<b>0 986 430 133</b>
, A [SK]	15,0	260-269	OM 442.942,966,972 A; OM 442.944,964,966 A	07.88-08.94	8	<b>0 432 231 704</b>	<b>0 986 430 133</b>
A [SK]	14,6	250	OM 440... <Euro 1>	12.91-08.94	8	<b>0 432 231 717</b>	<b>0 986 430 205</b>
<b>2636</b>	18,3	331	OM 443.940 A	01.90-03.91	10	<b>0 432 231 766</b>	<b>0 986 430 133</b>
, A	18,3	261	OM 423.905; OM 423.907	11.81-03.91	10	<b>0 432 231 680</b>	<b>0 986 430 038</b>
<b>2638</b>	14,6	276	OM 422.953,955 LA	01.81-12.86	8	<b>0 432 231 814</b>	<b>0 986 430 042</b>
, A [SK]	12,8	280	OM 402.971,972,975LA <Euro 1>; OM 402.975,978,996LA <Euro 1>	09.91-09.96	8	<b>0 432 231 665</b>	<b>0 986 430 205</b>
A [SK]	14,6	280	OM 446.927 (442) LA <Euro 2> Mot.Nr. →..860029	01.94-09.96	8	<b>0 432 131 800</b>	<b>0 986 430 264</b>
					8	<b>0 432 131 803</b> †	
			Mot.Nr. ...860030→	01.94-09.96	8	<b>0 432 131 728</b>	<b>0 986 430 327</b>
					8	<b>0 432 131 729</b> †	
<b>2644</b>	15,0	320	OM 442.951,953,980	10.85-02.90	8	<b>0 432 231 766</b>	<b>0 986 430 133</b>
[SK]	14,6	320	OM 440... <(442 LA) Euro 1> OM 446.922 (442) LA <Euro 2> Mot.Nr. →..860602	01.92-09.96	8	<b>0 432 231 677</b>	<b>0 986 430 211</b>
			Mot.Nr. ...860603→	01.94-09.96	8	<b>0 432 131 801</b>	<b>0 986 430 265</b>
					8	<b>0 432 131 804</b> †	
					8	<b>0 432 131 726</b>	<b>0 986 430 326</b>
					8	<b>0 432 131 730</b> †	
<b>2648</b> [SK]	15,0	353-362	OM 442...	12.88-07.92	8	<b>0 432 231 766</b>	<b>0 986 430 133</b>
<b>2650</b> [SK]	15,0	370	OM 442.997 LA <Euro 1>	07.92-09.96	8	<b>0 432 231 677</b>	<b>0 986 430 211</b>
<b>2653</b> [SK]	14,6	390	OM 446.. <Euro 2> Mot.Nr. →..860061	01.96-09.96	8	<b>0 432 131 802</b>	
					8	<b>0 432 131 805</b> †	
			Mot.Nr. ...860062→	01.96-09.96	8	<b>0 432 131 727</b>	<b>0 986 430 325</b>
					8	<b>0 432 131 731</b> †	





2653 A [SK]	14,6	390	OM 446... <Euro 2> Mot.Nr. →..860061	01.96-09.96	8	<b>0 432 131 802</b>	
					8	<b>0 432 131 805<sup>1</sup></b>	
			Mot.Nr. ..860062→	01.96-09.96	8	<b>0 432 131 727</b>	<b>0 986 430 325</b>
					8	<b>0 432 131 731<sup>1</sup></b>	
L [SK]	14,6	390	OM 446.920 (442) LA <Euro 2> Mot.Nr. →..860061	01.96-09.96	8	<b>0 432 131 802</b>	
					8	<b>0 432 131 805<sup>1</sup></b>	
			Mot.Nr. ..860062→	01.96-09.96	8	<b>0 432 131 727</b>	<b>0 986 430 325</b>
					8	<b>0 432 131 731<sup>1</sup></b>	
<b>30t</b>							
3025 B, K	14,6	184	OM 422.920	12.85-07.87	8	<b>0 432 231 680</b>	<b>0 986 430 038</b>
3028 , B, K	14,6	206	OM 422.905,911; OM 422.919	02.80-08.89	8	<b>0 432 231 680</b>	<b>0 986 430 038</b>
3033	14,6	243	OM 422.954,957	12.82-11.91	8	<b>0 432 231 684</b>	<b>0 986 430 042</b>
3036	18,3	261	OM 423.905,908	02.80-08.89	8	<b>0 432 231 680</b>	<b>0 986 430 038</b>
3038	14,6	276	OM 422.953,955,959LA	01.81-12.86	8	<b>0 432 231 814</b>	<b>0 986 430 042</b>
3050 [SK]	14,6	370	OM 440.976 (442) LA <Euro 1>	12.93-09.96	8	<b>0 432 231 677</b>	<b>0 986 430 211</b>
	15,0	370	OM 442.997 LA <Euro 1>	02.91-02.01	8	<b>0 432 231 677</b>	<b>0 986 430 211</b>
<b>32t</b>							
3225 B, K	14,6	184	OM 422.920	07.87-03.91	8	<b>0 432 231 680</b>	<b>0 986 430 038</b>
3228 B, K	14,6	206	OM 422.919,921	07.87-03.91	8	<b>0 432 231 680</b>	<b>0 986 430 038</b>
3229 [SK]	15,0	213	OM 442.927,928	09.89-08.94	8	<b>0 432 231 760</b>	<b>0 986 430 168</b>
3233 [SK]	11,0	250	OM 441.982,985 LA	10.90-07.92	6	<b>0 432 231 663</b>	<b>0 986 430 093</b>
3234 [SK]	11,0	250	OM 441.988,990,992LA <Euro 1>	02.92-09.96	6	<b>0 432 231 677</b>	<b>0 986 430 211</b>
3235 [SK]	15,0	260	OM 442.959 A	10.88-07.92	8	<b>0 432 231 663</b>	<b>0 986 430 093</b>
		260-269	OM 442.944	07.88-08.94	8	<b>0 432 231 704</b>	<b>0 986 430 133</b>
K	15,0	260	OM 442.950,952 A	07.87-01.89	8	<b>0 432 231 663</b>	<b>0 986 430 093</b>
3238 [SK]	12,8	280	OM 402... <Euro 1>	10.90-02.01	8	<b>0 432 231 665</b>	<b>0 986 430 205</b>
3244 [SK]	14,6	320	OM 440... <Euro 1>	10.90-02.01	8	<b>0 432 231 677</b>	<b>0 986 430 211</b>
3248 [SK]	15,0	362	OM 442.985 LA	07.87-09.96	8	<b>0 432 231 663</b>	<b>0 986 430 093</b>
3250 A	18,3	368	OM 423.950,951 LA	09.85-08.94	10	<b>0 432 231 684</b>	<b>0 986 430 042</b>
		412	OM 443.980 LA	01.90-09.93	10	<b>0 432 231 663</b>	<b>0 986 430 093</b>
3253 [SK]	14,6	390	OM 446.920,933,945LA <Euro 2> Mot.Nr. →..860061	01.96-09.96	8	<b>0 432 131 802</b>	
					8	<b>0 432 131 805<sup>1</sup></b>	
			Mot.Nr. ..860062→	01.96-09.96	8	<b>0 432 131 727</b>	<b>0 986 430 325</b>
					8	<b>0 432 131 731<sup>1</sup></b>	
<b>33t</b>							
3328 , B	14,6	206	OM 422.914, 919; OM 422.919	07.82-07.87	8	<b>0 432 231 680</b>	<b>0 986 430 038</b>
3333	14,6	243	OM 422.954 A	12.82-11.91	8	<b>0 432 231 684</b>	<b>0 986 430 042</b>
3336 , A	18,3	261	OM 423.905; OM 423.907	12.82-11.91	10	<b>0 432 231 680</b>	<b>0 986 430 038</b>
3338	14,6	260	OM 442.950	01.81-12.86	8	<b>0 432 231 684</b>	<b>0 986 430 042</b>
<b>35t</b>							
3528	14,6	206	OM 422.919	07.82-09.89	8	<b>0 432 231 680</b>	<b>0 986 430 038</b>
3535 , AK [SK]	15,0	266/269	OM 442.945,959 A; OM 442.946,957 A	10.88-08.94	8	<b>0 432 231 663</b>	<b>0 986 430 093</b>
AK, K	15,0	260	OM 442.950,952 A; OM 442.950,959 A	09.87-02.90	8	<b>0 432 231 663</b>	<b>0 986 430 093</b>
3538 , A [SK]	12,8	280	OM 402... <Euro 1>; OM 402.982,983 LA <Euro 1>	03.91-09.96	8	<b>0 432 231 665</b>	<b>0 986 430 205</b>
3544	15,0	320	OM 442.951,953,980	09.87-03.92	8	<b>0 432 231 663</b>	<b>0 986 430 093</b>
S [SK]	14,6	320	OM 440.970 (442) LA <LEV>	07.92-09.96	8	<b>0 432 231 677</b>	<b>0 986 430 211</b>
3548 S [SK]	14,6	370	OM 440.975 (442) LA <LEV>	05.92-07.92	8	<b>0 432 231 677</b>	<b>0 986 430 211</b>
	15,0	362	OM 442.993 LA	12.90-07.92	8	<b>0 432 231 663</b>	<b>0 986 430 093</b>
3550 S [SK]	14,6	370	OM 440.975 (442) LA <Euro 1>	05.92-09.96	8	<b>0 432 231 677</b>	<b>0 986 430 211</b>
3553 [SK]	14,6	390	OM 446.. <Euro 2> Mot.Nr. →..860061	01.96-09.96	8	<b>0 432 131 802</b>	
					8	<b>0 432 131 805<sup>1</sup></b>	
			Mot.Nr. ..860062→	01.96-09.96	8	<b>0 432 131 727</b>	<b>0 986 430 325</b>
					8	<b>0 432 131 731<sup>1</sup></b>	
L [SK]	14,6	390	OM 446.932 LA <Euro 2> Mot.Nr. →..860061	01.96-09.96	8	<b>0 432 131 802</b>	
					8	<b>0 432 131 805<sup>1</sup></b>	
			Mot.Nr. ..860062→	01.96-09.96	8	<b>0 432 131 727</b>	<b>0 986 430 325</b>
					8	<b>0 432 131 731<sup>1</sup></b>	





◀ MERCEDES-BENZ

38t								
3836	18,3	261	OM 423.907		11.81-03.91	10	0 432 231 680	0 986 430 038
3850 A	18,3	368	OM 423.950 LA		09.85-08.94	10	0 432 231 684	0 986 430 042
44t								
4435 K [SK]	15,0	260	OM 442.959 A		10.89-02.01	8	0 432 231 663	0 986 430 093
48t								
4844 [SK]	14,6	320	OM 440.979 <Euro 1>		07.92-09.96	8	0 432 231 677	0 986 430 211
4850 A	18,3	368	OM 423.950		07.87-08.96	10	0 432 231 684	0 986 430 042

**MITSUBISHI**

Canter								
2.4 D Turbo	2,4	70	4D55T		05.84-12.94	4	9 430 610 005	
Canter 35								
2.3 D [FB]	2,3	49	4D55		01.86-01.90	4	9 430 610 005	
2.5 D [FB]	2,5	51	4D56		CH 01.86-03.93	4	9 430 610 009	
					04.93-09.96	4	9 430 610 179	
				GH 01.86-03.93	4	9 430 610 154		
2.8 D Turbo [FB]	2,8	85	4M40		05.98-10.00	4	9 430 610 435	
D Turbo Interc. [FE]	2,8	85	4M40		05.98-10.00	4	9 430 610 435	
3C 11 [FB]	3,0	81	4M42 <Euro 3>		01.05-03.06	4	9 430 613 739	
3S 11 [FE]	3,0	81	4M42 <Euro 3>		01.05-03.06	4	9 430 613 739	
3.0 D Turbo [FB]	3,0	92	4M42		08.01-02.05	4	9 430 613 739	
					D Turbo Interc. [FE]	3,0	92	4M42-OAT
Canter 55								
3.0 D Turbo Interc. [FE]	3,0	92	4M42-OAT		11.00-02.05	4	9 430 613 739	
5S 13 [FE]	3,0	92	4M42-3A T1 <Euro 3>		01.05-03.06	4	9 430 613 739	
Canter 60								
3.3 D Turbo [FE]	3,3	85-86	4D310AT		A 04.91-08.91	4	9 430 612 426	
					01.86-08.87	4	9 430 610 046	
					09.87-03.91	4	9 430 610 102	
					09.91-09.96	4	9 430 612 575	
					A 04.91-08.91	4	9 430 612 575	
Canter 75								
5.0 D Turbo [FH]	5,0	107	6D310AT		01.88-07.97	6	9 430 610 102	
D Turbo Interc. [FH]	5,0	115	6D31T		07.88-12.92	6	9 430 610 127	
					01.93-07.97	6	9 430 612 563	
Fuso								
D	16,0	236	8DC91A		04.86-03.99	8	9 430 613 766	
6.6 D	6,6	118	6D142A		01.83-01.90	6	9 430 610 971	
					D Turbo	6,6	118	6D142A
L 200								
2.5 D Turbo	2,5	64	4D56		08.97-12.03	4	9 430 610 179	
L 300								
2.5 D Turbo	2,5	74	4D56		08.98-12.03	4	9 430 610 420	
L 300 Truck								
2.3 D [L]	2,3	49-50	4D55		06.84-10.86	4	9 430 610 009	
2.5 D [L]	2,5	52	4D56		11.86-05.94	4	9 430 610 154	
					D Turbo [P]	2,5	64	4D56
L 300 Van								
2.3 D [L]	2,3	49-50	4D55		06.84-10.86	4	9 430 610 009	
2.5 D Turbo 4WD [P]	2,5	62-64	4D56		11.88-05.94	4	9 430 610 154	
					06.94-12.01	4	9 430 610 179	
					D 2WD [P]	2,5	51	4D56
					06.94-12.01	4	9 430 610 179	





## MULTICAR

<b>M25</b>						
1.9 4x4	1,9	40	1Y <028.B>	01.91-12.92	4	0 432 217 210
<b>M26</b>						
1.9 4x4	1,9	40	1Y <028.B>	07.92-12.96	4	0 432 217 210

## NEFAZ NEFTEKAMSK

<b>Serie 50000</b>						
52996	9,2	265	PE265C <Euro 3>	01.08→	6	0 432 191 382
52997	9,2	228	PE228C <Euro 3>	01.08→	6	0 432 191 382
52999	12,6	315	XE315C <Euro 3>	12.06→	6	0 432 191 381

## NEOPLAN

<b>Tourline</b>						
2216 SHD	12,0	301	D2866 LOH34 <V4800, Euro 3>	11.03→	6	0 432 191 417 <sup>1</sup>
					6	0 432 191 419
			D2876 LOH03 <V4500, Euro 3>		11.03→	6
					6	0 432 191 416
2216/3 SHD-L	12,0	301	D2866 LOH34 <V4800, Euro 3>	11.03→	6	0 432 191 417 <sup>1</sup>
					6	0 432 191 419
			D2876 LOH03 <V4500, Euro 3>		11.03→	6
					6	0 432 191 416

## NISSAN

<b>Cabstar</b>									
2.0 D Turbo [F22]	2,0	60	LD20T	06.82-04.86	4	9 430 610 001			
				05.86-06.92	4	9 430 610 027			
2.3 D [F22]	2,3	54	SD23	12.81-06.92	4	9 430 610 006			
2.5 D [F22]	2,5	57	SD25	01.82-06.92	4	9 430 610 004			
				CH 06.94-05.96	4	9 430 610 065			
					07.92-05.94	4	9 430 610 065		
			CH 06.94-05.96	4	9 430 610 135				
3.3 D [H40]	3,3		ED33	12.81-01.89	4	9 430 610 004			
3.5	3,5	87	FD35T	11.96-12.99	4	9 430 611 356			
				D [H40]	3,5	FD35	11.86-12.88	4	9 430 611 367
							12.88-06.92	4	9 430 611 368
<b>Cabstar ZZ</b>									
4.6	4,6	90	FD46	11.99→	4	9 432 610 995			
<b>Cabstar 20</b>									
3.2	3,2	70	QD32	10.99-12.00	4	9 430 610 135			
				01.01→	4	9 430 613 540			
<b>Civilian</b>									
3.3 D [W40]	3,3		ED33	02.84-03.91	0	9 430 610 004			
4.2 D [W40]	4,2	99	TD42	03.91-03.01	0	9 430 610 065			
<b>Frontier</b>									
2.7 D	2,7	65-66	TD27	09.01→	4	9 430 613 540			
<b>L60</b>									
4.0 D	4,0	66	B4II	06.94-12.04	4	0 432 191 674			
<b>M</b>									
5.9 D	5,9	110	B660TII	03.93-12.08	0	0 432 191 675			
<b>Trade</b>									
2.0 D	2,0	41/46	LD20E; LD20IE	10.90-12.98	4	0 432 217 230			
3.0 D	3,0	63	BD30	04.93-12.98	4	9 430 610 116			
			BD30II	02.94-12.98	4	0 432 193 814			





## ◀ NISSAN

Urvan						
2.3 D [E23]	2,3	51	SD23	03.85-02.87	4	9 430 610 056
D [E24]	2,3	53	TD23	02.87-12.88	4	9 430 610 065
		55	TD23	11.86-03.89	4	9 430 610 048
2.5 D [E24]	2,5	59	TD25	12.88-07.94	4	9 430 610 065
				08.94-05.97	4	9 430 610 135
		63	TD25	03.89-06.97	4	9 430 610 065
2.7 D [E24]	2,7	62	TD27	11.86-06.97	4	9 430 610 065
Vanette						
2.0 D	2,0	48	LD20	09.84-07.89	4	9 430 610 001
					4	9 430 610 014
D [C120]	2,0	48-49	LD20	06.81-06.87	4	9 430 610 027
D [C220]	2,0	44/47-49	LD20II; LD20IIL	04.87-11.94	4	9 430 610 037
D [GC22]	2,0	47-49	LD20	09.86-04.93	4	9 430 610 033
Vanette Cargo						
2.0 D [C23M]	2,0	49	LD20	07.92-09.94	4	9 430 610 059
2.3 D [C23M]	2,3	55	LD23	09.94-11.01	4	0 432 117 001

## OPEL

Bedford-Blitz						
2.3 D CF	2,3	46	23 D <OHC>	09.80-07.87	4	0 432 217 052
Euromidi						
2.0 DT	2,0	51	4 FC1T	09.88-08.96 DKF	4	9 430 610 042
2.2 D	2,2	45	4 FD1	09.88-08.96 DKF	4	9 430 610 150
2.4 DT	2,4	56	4 FG1T	09.88-08.96 DKF	4	9 430 610 149

## OTOMARSAN

O 302						
	5,7	96	OM 353.906	12.75-12.89	6	0 432 231 887 0 986 430 056
	8,7	125/141	OM 360.916, 979; OM 360.980, 981	12.75-12.89	6	0 432 231 880

## PAZ PAVLOVO

Serie 3000						
3205	3,9	103	EQB-140-20 <Euro 2>	01.00→	4	0 432 193 549

## PEGASO (ENASA)

Serie 1200						
1223, .20	10,5	165	95T1BX (9222.00); 9222.00	05.82-12.89	6	0 432 292 870
1236 .38 R, T, Troner	12,0	265	96R1EX	04.87→	6	0 432 291 615
Serie 6000						
6424	12,0	177	T3/00061	01.85→	6	0 432 291 607

## PETERBILT

23						
.210	8,3	157	6 CT 8.3	12.86-12.96	6	9 430 082 715





**PEUGEOT**

<b>Boxer</b>							
1.9 D [U3]	1,9	50/51	DJY <XUD9A>; D9B <XUD9A>	02.94-02.02	4	0 432 217 248	0 986 430 244
D Turbo [U3]	1,9	66/68	DHX <XUD9TE>; D8C <XUD9TE>	02.94-02.02	4	0 432 217 245	
2.5 D [U3]	2,5	63	T9A <DJ5>	02.94-02.02	4	0 432 217 268	0 986 430 381
TDi [U3]	2,5	79-81	THX <DJ5TED>	10.96-02.02	4	0 432 193 728	
2.8 D	2,8	66		03.02-08.05	4	0 432 117 002	
D [U3]	2,8	64	8140 63 <SOFIM 2800>	01.99-02.02	4	0 432 117 002	
<b>J 5</b>							
1.9 D	1,9	51	D9B <XUD9A>	11.87-04.88 BO	4	0 432 217 181	
				05.88-12.93 BO	4	0 432 217 201	

**RENAULT**

<b>Agora</b>							
<b>Citybus</b>	9,9	144	MIDR 06.20.45 F/3 <Euro 2>	06.95-09.96 CSA	6	0 432 291 548	
		191	MIDR 06.20.45 I/3 <Euro 2>	06.95-09.96	6	0 432 291 558	0 986 430 337
		220	MIDR 06.20.45 J41	09.94→	6	0 432 191 616	0 986 430 348
<b>Ares</b>							
<b>300</b>	9,8	221	MIDR 06.20.45 R41 <Euro2>	04.98→	6	0 432 191 616	0 986 430 348
<b>340</b>	9,8	250	MIDR 06.20.45 M41 <Euro2>	04.98→	6	0 432 191 630	0 986 430 349
<b>B</b>							
<b>70</b>	2,5	53	8140.61.235	01.83-12.90	4	0 432 297 034	0 986 430 144
120 Messenger 4x2, Messenger 4x4	2,5	85	8140.47.2590 <Euro 1>	07.94-09.95	4	0 431 114 980 <sup>1</sup>	
<b>C</b>							
210 [Ligne 3]	8,8	153	MIDS 06.20.30 N	12.83-05.91	6	0 432 291 710	0 986 430 333
230 [Ligne 3]	6,2	166	MIDR 06.02.26 X <Euro 1>	05.92-10.98	6	0 432 131 823	
ti [Ligne 3]	6,2	166	MIDR 06.02.26 D	05.90-09.91	6	0 432 231 747	0 986 430 334
				10.91-07.92	6	0 432 231 700	
260 , T [Ligne 3]	9,8	192	MIDS 06.20.45 B	10.83-05.91	6	0 432 291 672	0 986 430 336
280 [Ligne 3]	9,8	202	MIDS 06.20.45 B	07.92-03.93	6	0 432 291 672	0 986 430 336
290 [Ligne 3]	9,8	214	MIDR 06.20.45 D	05.86-05.91	6	0 432 291 672	0 986 430 336
300 [Ligne 3]	9,8	222	MIDR 06.20.45 D/3 <Euro 1>	03.93-10.98 TW	6	0 432 291 672	0 986 430 336
				05.93-10.98 TW	6	0 432 291 558	0 986 430 337
340 ti [Ligne 3]	9,8	236	MIDR 06.20.45 E	07.90-03.93	6	0 432 291 621	0 986 430 338
		249	MIDR 06.20.45 E <Euro 1>	02.92-10.98	6	0 432 291 557	
			MIDR 06.20.45 E2	10.91-10.92	6	0 432 291 560	
<b>CBH</b>							
280	12,0	208	MIDS 06.35.40 D	04.86-10.92	6	0 432 291 718	0 986 430 141
320 6x4, 6x4T, 6x6, 6x6T	12,0	236	MIDR 06.35.40 M3 <Euro 1>	10.92-10.98	6	0 432 231 702	
340	12,0	243-247	MIDR 06.35.40 G	04.88-10.92	6	0 432 291 661	0 986 430 203
350	12,0	259	MIDR 06.35.40 G	05.90-01.93	6	0 432 291 661	0 986 430 203
380	12,0	275	MIDR 06.35.40 H	01.90-10.92	6	0 432 291 661	0 986 430 203
385 6x4, 6x4T, 6x6, 6x6T	12,0	283	MIDR 06.35.40 N3 <Euro 1>	10.92-10.98	6	0 432 231 667	0 986 430 330
<b>CLM</b>							
280	12,0	208	MIDS 06.35.40 D	04.86-10.92	6	0 432 291 718	0 986 430 141
320 , TR	12,0	236	MIDR 06.35.40 M3 <Euro 1>	10.92-10.98	6	0 432 231 702	
340	12,0	247	MIDR 06.35.40 G	02.88-10.91	6	0 432 291 661	0 986 430 203
385 , TR	12,0	283	MIDR 06.35.40 N3 <Euro 1>	10.92-10.98	6	0 432 231 667	0 986 430 330
<b>CLR</b>							
220	9,0	162	MIDS 06.20.30 N	05.86-05.91	6	0 432 291 710	0 986 430 333
290	10,0	210-214	MIDR 06.20.45 D	05.86-10.91	6	0 432 291 672	0 986 430 336
<b>FR</b>							
<b>1</b>	9,8	202	MIDR 06.20.45 A2	06.91-12.96	6	0 432 291 672	0 986 430 336
		222	MIDR 06.20.45 D	04.87-12.93	6	0 432 291 672	0 986 430 336
		250	MIDR 06.20.45 M	05.88-12.93	6	0 432 291 621	0 986 430 338
	10,0	206-210	MIDR 06.20.45 C	10.83-03.87	6	0 432 291 672	0 986 430 336
		11,0	250	Mack-EE6-335	01.84-11.92	6	9 430 233 008
-FRH	9,8	222	MIDR 06.20.45 D/3 <Euro 1>	12.92-12.96	6	0 432 291 558	0 986 430 337
		250	MIDR 06.20.45 M3 <Euro 1>	12.92-12.96	6	0 432 291 557	





◀ RENAULT

G								
200	6,2	137	MIDR 06.02.26 Q	06.91-04.93	6	0 432 231 741	0 986 430 344	
210	8,8	162	MIDS 06.20.30 N/1	11.83-02.90	6	0 432 291 710	0 986 430 333	
220	10,0	161	MIDS 06.20.45 J	03.91-04.93	6	0 432 291 672	0 986 430 336	
		168	MIDR 06.20.45 J/3 <Euro 1>	05.93-10.96 CSA	6	0 432 291 548		
230	8,8	169-177	MIDS 06.20.30 P	03.84-06.93	6	0 432 291 710	0 986 430 333	
	ti	6,2	166	MIDR 06.02.26 D	10.91-06.93	6	0 432 231 700	
235	9,8	168	MIDR 06.20.45 J/3 <Euro 1>	05.95-10.96 CSA	6	0 432 291 548		
260	9,8	188	MIDR 06.20.45 C/4 <Euro 2>	02.96-06.97	6	0 432 191 616	0 986 430 348	
		192/202	MIDR 06.20.45 A; MIDR 06.20.45 B	10.83-05.90	6	0 432 291 672	0 986 430 336	
280	9,8	202/206	MIDR 06.20.45 A; MIDR 06.20.45 D; MIDR 06.20.45 B	10.83-06.93	6	0 432 291 672	0 986 430 336	
		214	MIDR 06.20.45 D	05.85-12.89	6	0 432 291 672	0 986 430 336	
300	9,8	210-222	MIDR 06.20.45 D	01.90-03.93	6	0 432 291 672	0 986 430 336	
		219	MIDR 06.20.45 D/41 <Euro 2>	02.96-06.97	6	0 432 191 616	0 986 430 348	
		222	MIDR 06.20.45 D/3 <Euro 1>	09.92-10.96	6	0 432 291 558	0 986 430 337	
320	9,8	240	MIDR 06.20.45 H	05.88-05.90	6	0 432 291 621	0 986 430 338	
330	9,8	240	MIDR 06.20.45 H	02.90-03.93	6	0 432 291 621	0 986 430 338	
	ti	9,8	249	MIDR 06.20.45 E/2	10.91-10.92	6	0 431 214 033	
340 ti	9,8	236-249	MIDR 06.20.45 E	01.90-03.93	6	0 432 291 621	0 986 430 338	
		249	MIDR 06.20.45 E/41 <Euro 2>	02.96-06.97	6	0 432 191 630	0 986 430 349	
GBH								
280 E [M 4]	12,0	206-208	MIDS 06.35.40 D	06.80-05.87 WW	6	0 432 291 729		
				06.80-06.91	6	0 432 291 718	0 986 430 141	
GLM								
280 [M 4]	12,0	206	MIDS 06.35.40 D	06.80-05.87 WW	6	0 432 291 729		
				06.80-06.91	6	0 432 291 718	0 986 430 141	
GLR								
190	8,8	141	MID 06.20.30 G	09.78-06.91	6	0 432 291 819		
210	8,8	153	MIDS 06.20.30 N	12.83-06.90	6	0 432 291 710	0 986 430 333	
230 , 4x4	8,8	159	MIDS 06.20.30 B	06.80-06.91 CSA	6	0 432 291 767		
Iliade								
GT, GTC, GTE	9,9	222	MIDR 06.20.45 R41 <Euro 2>	10.96-09.01	6	0 432 191 616	0 986 430 348	
		250	MIDR 06.20.45 M41 <Euro 2>	10.96-09.01	6	0 432 191 630	0 986 430 349	
GTX, GTXE, RTX, TEX	9,9	222	MIDR 06.20.45 R41 <Euro 2>	10.96-09.01	6	0 432 191 616	0 986 430 348	
		250	MIDR 06.20.45 M41 <Euro 2>	10.96-09.01	6	0 432 191 630	0 986 430 349	
RT, RTC, TE, TEC	9,9	222	MIDR 06.20.45 R41 <Euro 2>	10.96-09.01	6	0 432 191 616	0 986 430 348	
		250	MIDR 06.20.45 M41 <Euro 2>	10.96-09.01	6	0 432 191 630	0 986 430 349	
JK								
60 B	3,6	67	720-12	10.79-01.86	4	0 432 281 066		
65	3,6	66	720-12	10.79-01.86	4	0 432 281 066		
75	3,6	66	720-12	10.79-01.86	4	0 432 281 066		
Kerax								
260	9,8	188	MIDR 06.20.45 C/4 <Euro 2>	06.97-12.02	6	0 432 191 616	0 986 430 348	
300	9,8	219	MIDR 06.20.45 D/41 <Euro 2>	06.97-12.02	6	0 432 191 616	0 986 430 348	
340	9,9	249	MIDR 06.20.45 E/41 <Euro 2>	06.97-12.02	6	0 432 191 630	0 986 430 349	
Magnum								
380 AE	12,0	275	MIDR 06.35.40 H	09.90-01.92	6		0 986 430 203	
385 AE	12,0	283	MIDR 06.35.40 L/1	02.92-07.93	6	0 432 231 668	0 986 430 329	
390 AE	12,0	287	MIDR 06.24.65 A42 <Euro 2, V-Mac>	09.96-05.00	6	0 432 193 833		
400 E.TECH	12,0	294	MACK E-TECH A <Euro 3>	03.01-09.04	6	0 432 193 534		
		295	MIDR 06.24.65 A46 <Euro 2>	11.99-03.01	6	0 432 193 528		
420 ti AE	12,0	305	MIDR 06.35.40 J3 <Euro 1>	10.92-10.96	6	0 432 231 667	0 986 430 330	
		314	MIDR 06.35.40 J1 <Euro 1>	02.92-07.93	6	0 432 231 668	0 986 430 329	
430 AE	12,0	316	MIDR 06.24.65 B42 <Euro 2, V-Mac>	09.96-05.00	6	0 432 193 833		
440 E. TECH	12,0	324	MACK E-TECH B <Euro 3>	03.01-09.04	6	0 432 193 534		
			MIDR 06.24.65 B46 <Euro 2>	11.99-03.01	6	0 432 193 528		
470 AE	12,0	346	MIDR 06.24.65 C42 <Euro 2, V-Mac>	11.96-05.00	6	0 432 193 796		
480 E. TECH	12,0	347	MIDR 06.24.65 C46 <Euro 2>	11.99-03.01	6	0 432 193 528		
		353	MACK E-TECH C <Euro 3>	03.01-01.05	6	0 432 193 534		
500 AE	16,4	370	Mack-EE9-502 4VH	09.90-10.92	8	0 432 191 757		
520 AE	16,5	390	Mack-EE9-530 <Euro 1>	10.92-05.96	8	0 432 191 757		
560 AE	16,5	412	V-Mack-EE9-560 <Euro 2>	04.96-05.00	8	0 432 191 757		





<b>Mascott</b>							
<b>90</b>	2,8	63	8140.63.2585; 8140.63.2586		01.99-06.04	4	<b>0 432 117 002</b>
<b>Master</b>							
<b>P28 -35D</b>	2,4	52	8140.61.2300		09.80-11.90	4	<b>0 432 297 034 0 986 430 144</b>
<b>T28 -35</b>	2,4	55	8140.67.2560 <S8U 748>		01.94-09.97	4	<b>0 432 297 057 0 986 430 532</b>
	2,5	69	8140.27.2590 <S9U 740>		01.94-09.97	4	<b>0 432 193 842<sup>1</sup></b>
						4	<b>0 432 193 843</b>
<b>-35D</b>	2,4	52-55	8140.61.2300 <S8U 731>; 8140.67.2510 <S8U 742>		09.80-09.97	4	<b>0 432 297 034 0 986 430 144</b>
	2,5	69	8140.27.2500,2510 <S9U 700> 8140.27.2510 <S9U 704>		09.80-09.97	4	<b>0 432 191 829</b>
			Mot.Nr. →1448380		09.80-09.97	4	<b>0 432 191 760</b>
			Mot.Nr. 1448381→		09.80-09.97	4	<b>0 432 191 725</b>
			8140.27.2512 <S9U 704>				
			Mot.Nr. →1448380		09.80-09.97	4	<b>0 432 191 760</b>
			Mot.Nr. 1448381→		09.80-09.97	4	<b>0 432 191 725</b>
			8140.27.2560 <S9U 714>		01.94-09.97	4	<b>0 432 193 845 0 986 430 256</b>
		72	8140.27.2580 <S9U 702>				
			Mot.Nr. →1459944		09.80-09.97	4	<b>0 432 191 725</b>
			Mot.Nr. 1459945→		09.80-09.97	4	<b>0 432 193 848</b>
<b>1.9 dTi 80 [X70]</b>	1,9	58	F9Q 770		01.00-09.03	4	<b>0 432 193 610<sup>1</sup></b>
						4	<b>0 432 193 611</b>
<b>2.5 D [X70]</b>	2,5	60	S8U 770 <8140.67.2620/29>; S8U 772		10.97-09.03	4	<b>0 432 297 057 0 986 430 532</b>
<b>2.8 D [X70]</b>	2,8	86	S8W 700		05.01-10.04	4	<b>0 432 117 002</b>
DTI	2,8	84	8140 TCA		01.02-09.04	4	<b>0 432 193 757 0 986 430 522</b>
dTi 110, dTi 120 [X70]	2,8	81/84	S9W 700 <Sofim8140.43,2609/39>; S9W 702 <Sofim8140.43,2620/29>		10.97-09.03	4	<b>0 432 193 757 0 986 430 522</b>
<b>Midliner</b>							
<b>M 150</b>	6,2	110	MIDR 06.02.26 U/4 <Euro 2>		05.96-12.00	6	<b>0 432 131 742</b>
<b>M 160</b>	5,5	124	MIDR 06.02.26 P		06.91-03.93	6	<b>0 432 231 741 0 986 430 344</b>
<b>M 180</b>	6,2	129	MIDR 06.02.26 V <Euro 1>		11.92-11.96	6	<b>0 432 231 699</b>
		132	MIDR 06.02.26 V4(1) <Euro 2>		05.96-01.00	6	<b>0 432 131 771</b>
<b>M 250</b>	6,2	184	MIDR 06.02.26 V4(1) <Euro 2>		01.97-01.00	6	<b>0 432 131 714 0 986 430 511</b>
<b>ME 210</b>	6,2	154	MIDR 06.02.26 W4 <Euro 2>		03.99-12.01	6	<b>0 432 131 767 0 986 430 347</b>
<b>Midlum</b>							
<b>210</b>	6,2	154	MIDR 06.02.26 W/4 <Euro 2>		02.00-06.01	6	<b>0 432 131 767 0 986 430 347</b>
<b>250</b>	6,2	184	MIDR 06.02.26 Y/41 <Euro 2>		02.00-06.01	6	<b>0 432 131 714 0 986 430 511</b>
<b>PR</b>							
<b>10 S</b>	8,8	158	MIDS 06.20.30		06.80-09.87 CSA	6	<b>0 432 291 767</b>
<b>12 S</b>	8,8	158	MIDS 06.20.30		06.80-03.86 CSA	6	<b>0 432 291 767</b>
<b>14 S</b>	8,8	166	MIDS 06.20.30 D		06.80-09.86 CSA	6	<b>0 432 291 767</b>
SR	8,8	188-191	MIDR 06.20.30 A		10.80-09.86	6	<b>0 432 291 710 0 986 430 333</b>
<b>100 -2</b>	9,8	129/144	MIPS 06.20.45 A; MIPS 06.20.45 C		06.84-06.92	6	<b>0 432 291 672 0 986 430 336</b>
		152	MIPR 06.20.45 C3 <Euro 1>		10.92-05.95 CSA	6	<b>0 432 291 548</b>
		186	MIPR 06.20.45 B3 <Euro 1>		10.92-05.94	6	<b>0 432 291 558 0 986 430 337</b>
<b>180</b>	8,8	166	MIPS 06.20.30		03.83-12.89 CSA	6	<b>0 432 291 767</b>
, -2	9,8	144/169/ 176/202	MIDR 06.20.45 A2; MIDS 06.20.45; MIPS 06.20.45 B; MIPS 06.20.45 C		06.84→	6	<b>0 432 291 672 0 986 430 336</b>
-2	9,8	186/222	MIPR 06.20.45 A3 <Euro 1>; MIPR 06.20.45 B3 <Euro 1>		10.92-05.94	6	<b>0 432 291 558 0 986 430 337</b>
<b>Premium</b>							
<b>210 Distribution</b>	6,2	154	MIDR 06.02.26 W4 <Euro 2>		04.96-09.01	6	<b>0 432 131 767 0 986 430 347</b>
<b>250 Distribution</b>	6,2	184	MIDR 06.02.26 Y41 <Euro 2>		01.97-09.01	6	<b>0 432 131 714 0 986 430 511</b>
<b>260 Distribution, SP</b>	9,8	188	MIDR 06.20.45 C/4 <Euro 2>		04.96-12.01	6	<b>0 432 191 616 0 986 430 348</b>
<b>300 Distribution, Route</b>	9,8	219	MIDR 06.20.45 D/41 <Euro 2>		02.96-09.01	6	<b>0 432 191 616 0 986 430 348</b>
<b>340 Distribution, Route</b>	9,8	249	MIDR 06.20.45 E/41 <Euro 2>		04.96-03.01	6	<b>0 432 191 630 0 986 430 349</b>
<b>R</b>							
<b>TS 6x4 Major</b>	12,0	305	MIDR 06.35.40 J3 <Euro 1>		01.93-05.96	6	<b>0 432 231 667 0 986 430 330</b>
<b>212</b>	5,5	117	MIDR 06.02.12 B		01.90-05.90	6	<b>0 432 281 695 0 986 430 342</b>
<b>312</b>	9,8	129/144	MIDS 06.20.45 D; MIDS 06.20.45 F		11.86-12.03	6	<b>0 432 291 672 0 986 430 336</b>
		152	MIDR 06.20.45 F3 <Euro 1>		10.92-12.03 CSA	6	<b>0 432 291 548</b>
<b>332</b>	9,8	185	MIHS 06.20.45 A		06.89-12.03	6	<b>0 432 291 672 0 986 430 336</b>
		186-191	MIHR 06.20.45 A3 <Euro 1>		09.92-12.03	6	<b>0 432 291 558 0 986 430 337</b>





◀ RENAULT

<b>340</b>	9,8	249	MIDR 06.20.45 E/2	02.90-12.92	6	<b>0 432 291 560</b>
<b>357</b>	12,0	263-264	MIDR 06.35.40 H	01.86-10.96	6	<b>0 986 430 203</b>
<b>365</b>	12,0	264-275	MIDR 06.35.40 H	10.87-05.90	6	<b>0 986 430 203</b>
<b>380</b>	12,0	276	MIDR 06.35.40 H	01.90-01.92	6	<b>0 986 430 203</b>
<b>385</b>	12,0	283	MIDR 06.35.40 L1	12.91-03.93	6	<b>0 432 231 668 0 986 430 329</b>
			MIDR 06.35.40 N3 <Euro 1>	09.93-10.96	6	<b>0 432 231 667 0 986 430 330</b>
<b>420</b>	12,0	305	MIDR 06.35.40 J3 <Euro 1>	10.92-10.96	6	<b>0 432 231 667 0 986 430 330</b>
		314	MIDR 06.35.40 J1	09.91-03.93	6	<b>0 432 231 668 0 986 430 329</b>
<b>S</b>						
<b>45 R, RX</b>	7,3	118	D 0846 HM 42 U	06.80-12.94	6	<b>0 432 231 014</b>
<b>53 R, RX</b>	7,3	118	D 0846 HM 42 U	06.80-12.94	6	<b>0 432 231 014</b>
<b>90</b>	3,6	67	720.12.01	05.84-06.91	4	<b>0 432 281 066</b>
<b>105 R, RA, RAX, RX</b>	7,3	118	D 0846 HM 42 U	01.83-12.94	6	<b>0 432 231 014</b>
<b>110 Midliner</b>	5,5	76	797-21	06.85-09.90	6	<b>0 432 281 066</b>
<b>120 Midliner</b>	4,0	82	Phaser 110 T <T4.40 A/3, Euro 1>	06.93-06.96	4	<b>0 432 193 828</b>
<b>130 Export, Midliner</b>	5,5	89/96-97	797 NFA; 797.20; 797.23 Export	05.83-06.91	6	<b>0 432 281 066</b>
<b>135 Midliner</b>	4,0	102	Phaser 110 T <T4.40 B/3, Euro 1>	02.94-05.96	4	<b>0 432 193 817</b>
	4,1	100	MIDR 04.02.26 A/4 <Euro 2>	05.96-01.00	4	<b>0 432 131 732</b>
<b>150</b>	5,5	113	798-10	05.83-07.86	6	<b>0 432 281 093</b>
Midliner	5,5	110	MIDR 06.02.12 D3 <Euro 1>	01.94-05.96	6	<b>0 432 131 785</b>
	6,2	110	MIDR 06.02.26 U <Euro 1>	11.92-01.94	6	<b>0 432 271 661</b>
			MIDR 06.02.26 U4 <Euro 2>	05.96-01.00	6	<b>0 432 131 742</b>
<b>180 Midliner</b>	6,2	129	MIDR 06.02.26 V <Euro 1>	11.92-10.96	6	<b>0 432 231 699</b>
		132	MIDR 06.02.26 V4 <Euro 2>	05.96-01.00	6	<b>0 432 131 771</b>
<b>SG</b>						
<b>2</b>	3,3	54	712-01-03	10.79-09.86	4	<b>0 432 281 066</b>
<b>3</b>	3,3	53	712-01-03	10.79-09.86	4	<b>0 432 281 066</b>
<b>4</b>	3,6	67	720	06.80-09.86	4	<b>0 432 281 066</b>
<b>TBH</b>						
<b>280 D</b>	12,0	178	MDS 06.35.40 H	06.80-06.91	6	<b>0 432 281 713</b>
E	12,0	206-208	MIDS 06.35.40 D	01.81-06.91	6	<b>0 432 291 718 0 986 430 141</b>
<b>TLM</b>						
<b>280</b>	12,0	206	MIDS 06.35.40 D	06.80-05.87 WW	6	<b>0 432 291 729</b>
				06.80-05.91	6	<b>0 432 291 718 0 986 430 141</b>
<b>Tracer</b>						
	9,8	185/186	MIHS 06.20.45 A; MIHS 06.20.45 B	03.92-05.93	6	<b>0 432 291 672 0 986 430 336</b>
		186-191	MIHR 06.20.45 A3 <Euro 1>	06.93-09.96	6	<b>0 432 291 558 0 986 430 337</b>
<b>Trafic</b>						
<b>2.1 D</b>	2,1	47	J8S 620; J8S 622; J8S 758	09.94-10.97	4	<b>0 432 217 259</b>
<b>2.5 D</b>	2,5	52-55	Sofim 8140.61.240 <S8U 722>	10.81-02.89	4	<b>0 432 297 034 0 986 430 144</b>
		55	8140.67.2500 <S8U 750>	03.90-10.97	4	<b>0 432 297 034 0 986 430 144</b>
			8140.67.2580 <S8U 752>	03.89-10.97	4	<b>0 432 297 054</b>
D, D 4x4	2,5	55	S8U 758; S8U 758	09.94-05.01	4	<b>0 432 297 057 0 986 430 532</b>
			<Sofim8140.67.2550/52>; S8U 780			
			S8U 782	11.97-05.01 BO	4	<b>0 432 297 057 0 986 430 532</b>
<b>Winnebago</b>						
<b>2.1 D</b>	2,1	57	J8S 234	03.83-06.87	4	<b>0 432 297 045</b>
<b>50</b>						
	4,0	63	Phaser 90	08.87-10.90	4	<b>0 432 291 620</b>
		82	Phaser 110T <T4.40>	08.87-03.93	4	<b>0 432 291 638</b>
<b>75</b>						
<b>.130</b>	5,5	96	797-20	12.82-05.91	6	<b>0 432 281 066</b>
<b>85</b>						
<b>.150</b>	5,5	113	798-20	09.84-10.91	6	<b>0 432 281 093</b>
<b>95</b>						
<b>.130</b>	5,5	96	797-20	12.82-05.91	6	<b>0 432 281 066</b>
<b>110</b>						
<b>.150</b>	5,5	113	798-20	06.80-10.91	6	<b>0 432 281 093</b>
ti	5,5	117	MIDS 06.02.12 B	10.91-01.95	6	<b>0 432 281 695 0 986 430 342</b>
<b>.170, ti</b>	5,5	127/134	MIDR 06.02.12 D	09.85-01.95	6	<b>0 432 281 708</b>





**SCANIA**

<b>Serie 82</b>										
<b>F</b>	CL [BUS]	7,8		DS 8.05 B		10.81-01.95		6	<b>0 432 292 887</b>	
<b>G</b>		7,8	123	DN 8.01		05.80-03.88		6	<b>0 432 292 886</b>	
			140	DS 8.06		10.82-03.88		6	<b>0 432 292 887</b>	
			155	DS 8.05		01.81-03.88		6	<b>0 432 292 887</b>	
			178	DSI 8.01		02.81-03.88		6	<b>0 432 292 882</b>	
<b>K</b>	CL, CR [BUS]	7,8		DSI 8.01 B		06.85-12.95		6	<b>0 432 292 882</b>	
<b>P</b>		7,8	123	DN 8.01		05.80-03.88		6	<b>0 432 292 886</b>	
			140	DS 8.06		10.82-03.88		6	<b>0 432 292 887</b>	
			155	DS 8.05		01.81-03.88		6	<b>0 432 292 887</b>	
			178	DSI 8.01		02.81-03.88		6	<b>0 432 292 882</b>	
<b>S</b>	CL, HR [BUS]	7,8		DS 8.05 B		10.81-10.91		6	<b>0 432 292 887</b>	
<b>T</b>		7,8	123	DN 8.01		05.80-03.88		6	<b>0 432 292 886</b>	
			140/155	DS 8.05; DS 8.06		02.81-03.88		6	<b>0 432 292 887</b>	
			154	DS 8.01		05.80-03.88		6	<b>0 432 292 887</b>	
			178	DSI 8.01		02.81-03.88		6	<b>0 432 292 882</b>	
<b>Serie 86</b>										
<b>B</b>	[BUS]	7,8	114	D 8.01 B09, .02 B09		06.82-01.90		6	<b>0 432 292 886</b>	
	S [BUS]	7,8	155	DS 8.01 B10		06.82-01.95		6	<b>0 432 292 887</b>	
<b>BF</b>	[BUS]	7,8	114	D 8.01 B09, .02 B09		06.82-01.99		6	<b>0 432 292 886</b>	
	S [BUS]	7,8	155	DS 8.01 B10		06.82-01.99		6	<b>0 432 292 887</b>	
<b>BR</b>	S [BUS]	7,8	155	DS 8.01 B11,B12		10.76-12.90		6	<b>0 432 292 887</b>	
<b>Serie 92</b>										
<b>G</b>		8,5	128/167/	DN 9.01; DS 9.01; DS 9.02; DS 9.05; DS 9.06;		01.85-03.88		6	<b>0 432 131 850 0986 430 031</b>	
			169/180/	DSC 9.01; DSC 9.02						
<b>K</b>	CL [BUS]	0,0		DS 9.03 B 01,02		05.82-06.89		6	<b>0 432 131 850 0986 430 031</b>	
						07.89-12.94		6	<b>0 432 131 850 0986 430 031</b>	
	CR [BUS]	0,0		DS 9.03 B 01,02		05.82-06.89		6	<b>0 432 131 850 0986 430 031</b>	
						07.89-12.94		6	<b>0 432 131 850 0986 430 031</b>	
<b>P</b>		8,5	128/167/	DN 9.01; DS 9.01; DS 9.02; DS 9.05; DS 9.06;		01.85-03.88		6	<b>0 432 131 850 0986 430 031</b>	
			169/180/	DSC 9.01; DSC 9.02						
			187/202/							
<b>R</b>		8,5	128/167/	DN 9.01; DS 9.01; DS 9.02; DS 9.05; DS 9.06;		01.85-03.88		6	<b>0 432 131 850 0986 430 031</b>	
			169/180/	DSC 9.01; DSC 9.02						
			187/202/							
			209							
<b>T</b>		8,5	128/167/	DN 9.01; DS 9.01; DS 9.02; DS 9.05; DS 9.06;		01.85-03.88		6	<b>0 432 131 850 0986 430 031</b>	
			169/180/	DSC 9.01; DSC 9.02						
			187/202/							
			209							
<b>Serie 93</b>										
<b>F</b>	HL/HR [BUS]	8,5	127/167	DN 9.01; DS 9.06		06.90-01.98		6	<b>0 432 131 850 0986 430 031</b>	
<b>G</b>	L, R	8,5	155/162/	DS 9.05; DS 9.06; DS 9.08; DSC 9.02;		03.88-08.97		6	<b>0 432 131 850 0986 430 031</b>	
			167/185/	DSC 9.07 <Euro 1>; DSC 9.08 <Euro 1>;						
			207/208	DSC 9.10 <Euro 1>						
<b>K</b>	CL, CLB, CR [BUS]	8,5	208	DSC 9.08 <Euro 1>		11.87-02.97		6	<b>0 432 131 850 0986 430 031</b>	
						11.87-12.01		6	<b>0 432 131 850 0986 430 031</b>	
	CLB [BUS]	8,5	185	DS 9.05 B 01,02		11.87-06.89		6	<b>0 432 131 850 0986 430 031</b>	
						07.89-02.97		6	<b>0 432 131 850 0986 430 031</b>	
	CRB [BUS]	8,5	185	DS 9.05 B 01,02		11.87-06.89		6	<b>0 432 131 850 0986 430 031</b>	
						07.89-02.97		6	<b>0 432 131 850 0986 430 031</b>	
<b>P</b>	L	8,5	167	DS 9.06						
						Mot.Nr. EN5094163-SSS→	03.88-08.97		6	<b>0 432 131 850 0986 430 031</b>
	L, R	8,5	128/185	DN 9.01; DS 9.05		03.88-01.91		6	<b>0 432 131 850 0986 430 031</b>	
					155/207	DS 9.08; DSC 9.02		03.88-01.95		6





◀ SCANIA

<b>P</b>	L, R	8,5	162/185/	DSC 9.07 <Euro 1>; DSC 9.08 <Euro 1>;	12.91-08.97	6	<b>0 432 131 850</b>	<b>0 986 430 031</b>			
			208	DSC 9.10 <Euro 1>							
			167	DS 9.06					03.88-01.93	6	<b>0 432 131 850</b>
<b>R</b>	L	8,5	155/167/	DS 9.05; DS 9.06; DS 9.08; DSC 9.02	03.88-01.95	6	<b>0 432 131 850</b>	<b>0 986 430 031</b>			
			184	DSC 9.09 <Euro 2>					12.91-08.97	6	<b>0 432 131 807</b>
			185/207	DSC 9.07 <Euro 1>; DSC 9.08 <Euro 1>;					12.91-08.97	6	<b>0 432 131 850</b>
208	DSC 9.10 <Euro 1>										
<b>T</b>		8,5	128/155/	DN 9.01; DS 9.05; DS 9.06; DS 9.08;	03.88-08.97	6	<b>0 432 131 850</b>	<b>0 986 430 031</b>			
			162/167/	DSC 9.02; DSC 9.07 <Euro 1>; DSC 9.08							
			185/207/	<Euro 1>; DSC 9.10 <Euro 1>							
			208								

**Serie 94**

<b>K</b>	E, IB [BUS]	9,0	228	DSC 9.15 <Euro 2>	09.97-10.00	6	<b>0 432 131 692</b>			
<b>L</b>	IB, UB [BUS]	9,0	162	DSC 9.11 <Euro 2>	03.97-08.02	6	<b>0 432 131 684</b>			
			169	DC 9.01 <Euro 3>	04.99→	6	<b>0 432 191 494<sup>1</sup></b>			
								6	<b>0 432 191 495</b>	
			191	DC 9.02 <Euro 3>	02.00→	6	<b>0 432 191 494<sup>1</sup></b>			
								6	<b>0 432 191 495</b>	
						DSC 9.12 <Euro 2>	03.97-10.01	6	<b>0 432 131 616</b>	
			221	DC 9.03 <Euro 3>	02.00→	6	<b>0 432 191 464<sup>1</sup></b>			
					6	<b>0 432 191 465</b>				
			228	DSC 9.13 <Euro 2>	03.97-08.02	6	<b>0 432 131 692</b>			
				DSC 9.15 <Euro 2>	03.97-10.00	6	<b>0 432 131 692</b>			
<b>N</b>	UB [BUS]	9,0	162	DSC 9.11 <Euro 2>	09.97-08.02	6	<b>0 432 131 684</b>			
<b>P,R</b>	220	9,0	162	DSC 9.11 <Euro 2>	08.96-08.02	6	<b>0 432 131 684</b>			
			230	DC 9.01 <Euro 3>	04.99-09.04	6	<b>0 432 191 494<sup>1</sup></b>			
							6	<b>0 432 191 495</b>		
	260	9,0	191	DC 9.02 <Euro 3>	02.00-09.04	6	<b>0 432 191 494<sup>1</sup></b>			
						6	<b>0 432 191 495</b>			
						DSC 9.12 <Euro 2>				
				Mot.Nr. →4026981 SNL →5123774 SSS	08.96-10.01	6	<b>0 432 131 616</b>			
				Mot.Nr. 4026982 SNL → 5123775 SSS→	08.96-10.01	6	<b>0 432 131 616</b>			
300		9,0	221	DC 9.03 <Euro 3>	02.00-09.04	6	<b>0 432 191 464<sup>1</sup></b>			
						6	<b>0 432 191 465</b>			
						DC 9.06 <Euro 3>	09.00-09.04	6	<b>0 432 191 464<sup>1</sup></b>	
					6	<b>0 432 191 465</b>				
310		9,0	228	DSC 9.13 <Euro 2>	08.96-08.02	6	<b>0 432 131 692</b>			
						6	<b>0 432 131 692</b>			
						DSC 9.15 <Euro 2>	08.96-10.00	6	<b>0 432 131 692</b>	
<b>T</b>	220	9,0	162	DSC 9.11 <Euro 2>	08.96-08.02	6	<b>0 432 131 684</b>			
			230	DC 9.01 <Euro 3>	04.99-09.04	6	<b>0 432 191 494<sup>1</sup></b>			
					6	<b>0 432 191 495</b>				
260		9,0	191	DC 9.02 <Euro 3>	02.00-09.04	6	<b>0 432 191 494<sup>1</sup></b>			
						6	<b>0 432 191 495</b>			
						DSC 9.12 <Euro 2>				
				Mot.Nr. →4026981 SNL →5123774 SSS	08.96-10.01	6	<b>0 432 131 616</b>			
				Mot.Nr. 4026982 SNL →5123775 SSS→	08.96-10.01	6	<b>0 432 131 616</b>			
300		9,0	221	DC 9.03 <Euro 3>	02.00-09.04	6	<b>0 432 191 464<sup>1</sup></b>			
						6	<b>0 432 191 465</b>			
						DC 9.06 <Euro 3>	09.00-09.04	6	<b>0 432 191 464<sup>1</sup></b>	
					6	<b>0 432 191 465</b>				
310		9,0	228	DSC 9.13 <Euro 2>	08.96-08.02	6	<b>0 432 131 692</b>			
						6	<b>0 432 131 692</b>			
						DSC 9.15 <Euro 2>	08.96-10.00	6	<b>0 432 131 692</b>	

**Serie 111**

<b>B</b>	[BUS]	11,0		DN 11.01 B10, 04 B10	06.90-01.99	6	<b>0 432 281 748</b>	
<b>BF</b>	, CKD [BUS]	11,0		DS 11.01 B 06	01.99-01.99	6	<b>0 432 281 748</b>	

**Serie 112**

<b>BK</b>	CLB [BUS]	11,0		DSC 11.01 B	05.82-11.90	6	<b>0 432 292 881</b>	<b>0 986 430 074</b>
			143	DN 11.06 B	05.82-11.99	6	<b>0 432 292 880</b>	
			224	DS 11.15 B	05.82-11.99	6	<b>0 432 292 881</b>	<b>0 986 430 074</b>





BR [BUS]	11,0	149	D 11	09.78-12.90	6	0 432 281 748		
		184	DS 11.01, 14	01.83-12.90	6	0 432 292 879		
		232	DS 11.15	07.81-12.91	6	0 432 292 881	0 986 430 074	
CR [BUS]	11,0	149	D 11	09.78-12.89	6	0 432 281 748		
		184	DS 11.01, 14	01.83-12.90	6	0 432 292 879		
		232	DS 11.15	07.81-12.92	6	0 432 292 881	0 986 430 074	
F [BUS]	11,0	139	DN 11.07	10.81-01.95	6	0 432 292 880		
		224	DS 11.15	10.81-01.95	6	0 432 292 881	0 986 430 074	
G,P,R 280	11,0	206	DS 11.14	11.82-05.88	6	0 432 292 879		
305, 333	11,0	225/245	DS 11.15; DSC 11.01	01.81-05.88	6	0 432 292 881	0 986 430 074	
313, 316, 345	11,0	230/232/254	DS 11.18; DS 11.72; DS 11.73	06.87-05.88	6	0 432 292 881	0 986 430 074	
345	11,0	254	DSC 11.12	06.87-05.88	6	0 432 192 881	0 986 430 034	
363	11,0	267	DSC 11.02	12.86-05.88	6	0 432 292 881	0 986 430 074	
K CLB [BUS]	11,0	143	DN 11.06 B	05.82-06.90	6	0 432 292 880		
		224	DS 11.15 B	04.82-06.90	6	0 432 292 881	0 986 430 074	
CLB, P [BUS]	11,0	224/254	DS 11.15; DSC 11.01; DSC 11.01 B	06.82-12.95	6	0 432 292 881	0 986 430 074	
203	11,0	149	DN 11.01	07.83-12.86	6	0 432 292 880		
N CLB [BUS]	11,0	158	DN 11.01 C 09; DN 11.04 C 01	01.90-12.00	6	0 432 292 880		
P	11,0	229/254	DSC 11.03; DSC 11.06	05.85-05.88	6	0 432 192 881	0 986 430 034	
R	11,0	229/254	DSC 11.03; DSC 11.06	05.85-05.88	6	0 432 192 881	0 986 430 034	
S [BUS]	11,0	139-151	DN 11.07	10.81-10.91	6	0 432 292 880		
		224	DS 11.15	10.81-10.91	6	0 432 292 881	0 986 430 074	
T , 345	11,0	229/254	DSC 11.03; DSC 11.06; DSC 11.12	05.85-05.88	6	0 432 192 881	0 986 430 034	
		215	DN 11.01	11.82-05.88	6	0 432 292 880		
		280, 290	206/213	DS 11.01; DS 11.14	11.82-05.88	6	0 432 292 879	
		305	225	DS 11.15	01.81-05.88	6	0 432 292 881	0 986 430 074
		313, 316	230/232	DS 11.72; DS 11.73	06.87-05.88	6	0 432 292 881	0 986 430 074
		316	232	DS 11.02	01.83-05.88	6	0 432 292 879	
		316, 333, 345	232/245/254	DS 11; DS 11.18; DSC 11.01	02.82-06.89	6	0 432 292 881	0 986 430 074
<b>Serie 113</b>								
BN ALB [BUS]	11,0	228	DS 11.34; DSC 11.08 C	05.90-08.98	6	0 432 131 871	0 986 430 120	
		CLB [BUS]	11,0	134	DN 11.06 C	05.90-08.98	6	0 432 292 880
		189	DS 11.71	05.90-08.98	6	0 432 131 825	0 986 430 213	
			DSC 11.04	05.90-08.98 CSA	6	0 432 131 859		
CN [BUS]	11,0	189	DSC 11.04	01.90-08.98 CSA	6	0 432 131 859		
, A [BUS]	11,0	189/228	DS 11.34; DS 11.74; DSC 11.08	01.90-08.98	6	0 432 131 871	0 986 430 120	
F HL/HR [BUS]	11,0	228	DS 11.34	06.90-08.98	6	0 432 131 871	0 986 430 120	
K CLA/CRA, CLB, TLA/TRA, TLB [BUS]	11,0		DSC 11.35	07.90-08.98	6	0 432 131 846	0 986 430 274	
			DSC 11.36	07.90-08.98	6	0 432 131 846	0 986 430 274	
		235	DSC 11.21 <Euro 1>					
			Mot.Nr. →5333533 SSS	07.90-08.98	6	0 432 131 846	0 986 430 274	
			Mot.Nr. 5333534 SSS→	07.90-08.98	6	0 432 131 825	0 986 430 213	
		266	DSC 11.23 <Euro 1>	07.90-08.98	6	0 432 131 846	0 986 430 274	
		280	DSC 11.22 <Euro 1>	07.90-08.98	6	0 432 131 825	0 986 430 213	
		CLB [BUS]	11,0	DS 11.78	07.90-08.98	6	0 432 131 825	0 986 430 213
			134	DN 11.06 C	05.82-06.90	6	0 432 292 880	
			230	DS 11.73 B	05.82-06.90	6	0 432 292 881	0 986 430 074
	239	DSC 11.16 B						
		Mot.Nr. →5307828	05.82-06.90	6	0 432 192 881	0 986 430 034		
CLB, TLA/TRA [BUS]	11,0	305	DSC 11.81	05.82-08.98	6	0 432 131 744		
CLB, TLA/TRA, TLB [BUS]	11,0	267	DSC 11.13 B	05.82-06.90	6	0 432 192 881	0 986 430 034	
				05.82-08.98	6	0 432 192 881	0 986 430 034	
			DSC 11.18	07.90-08.98	6	0 432 131 871	0 986 430 120	
	280	DSC 11.70 <Euro 2>	05.82-08.98	6	0 432 131 825	0 986 430 213		
CLB, TLB [BUS]	11,0	189/228/235	DS 11.74; DSC 11.08; DSC 11.17	07.90-08.98	6	0 432 131 871	0 986 430 120	
		228	DS 11.34	07.90-08.98	6	0 432 131 871	0 986 430 120	
		265	DS 11.75	07.90-08.98	6	0 432 131 825	0 986 430 213	





◀ SCANIA

<b>K</b>	TLB [BUS]	11,0	228	DSC 11.08 B	01.91-08.98	6	<b>0 432 131 871</b>	<b>0 986 430 120</b>	
			230	DS 11.73	07.90-08.98	6	<b>0 432 292 881</b>	<b>0 986 430 074</b>	
			239	DSC 11.16 B					
				Mot.Nr. →5307828	01.91-08.98	6	<b>0 432 192 881</b>	<b>0 986 430 034</b>	
		203	11,0	149	DN 11.08	01.90-12.94	6	<b>0 432 131 848</b>	
	203, 320	11,0	149/236	DS 11.34 B0 6; DSC 11.01	01.90-12.99	6	<b>0 432 131 871</b>	<b>0 986 430 120</b>	
	303	11,0	223	DS 11.34					
				Fg.Nr. →1327376	01.90-12.94	6	<b>0 432 131 825</b>	<b>0 986 430 213</b>	
				Fg.Nr. →3462121	01.90-12.94	6	<b>0 432 131 871</b>	<b>0 986 430 120</b>	
<b>L</b>	CLB [BUS]	11,0	180	DSC 11.27 <EDC>	01.92-08.98	6	<b>0 432 131 825</b>	<b>0 986 430 213</b>	
			189/228	DS 11.34; DS 11.74; DSC 11.08	01.90-08.98	6	<b>0 432 131 871</b>	<b>0 986 430 120</b>	
	CLB, CLL [BUS]	11,0		DS 11.78; DSC 11.71	12.94-08.98	6	<b>0 432 131 825</b>	<b>0 986 430 213</b>	
			191-193	DSC 11.24 <EDC>	11.93-08.98	6	<b>0 432 131 789</b>		
			235	DSC 11.21 <Euro 1>					
			Mot.Nr. →5333533 SSS	01.90-08.98	6	<b>0 432 131 846</b>	<b>0 986 430 274</b>		
			Mot.Nr. 5333534 SSS→	01.90-08.98	6	<b>0 432 131 825</b>	<b>0 986 430 213</b>		
<b>N</b>	ALB [BUS]	11,0	228	DS 11.34	09.91-06.92	6	<b>0 432 131 871</b>	<b>0 986 430 120</b>	
				DSC 11.08	09.91-08.98	6	<b>0 432 131 871</b>	<b>0 986 430 120</b>	
				230	DS 11.73	09.91-06.92	6	<b>0 432 292 881</b>	<b>0 986 430 074</b>
	ALB, CLB [BUS]	11,0	191	DSI 11 EO 1	03.92-08.98	6	<b>0 432 231 691</b>		
				235	DSC 11.21 <Euro 1>				
					Mot.Nr. →5333533 SSS	09.91-08.98	6	<b>0 432 131 846</b>	<b>0 986 430 274</b>
				Mot.Nr. 5333534 SSS→	09.91-08.98	6	<b>0 432 131 825</b>	<b>0 986 430 213</b>	
	ALB, CLB, CLL/CRL [BUS]	11,0	189	DS 11.74	04.91-06.92	6	<b>0 432 131 871</b>	<b>0 986 430 120</b>	
					04.91-08.98	6	<b>0 432 131 871</b>	<b>0 986 430 120</b>	
	ALB, CLB, DRB [BUS]	11,0	189	DS 11.71	09.91-06.92	6	<b>0 432 192 876</b>		
					09.91-08.98	6	<b>0 432 192 876</b>		
	CLB [BUS]	11,0		189	DS 11.77				
					Mot.Nr. →5333533 SSS	04.95-08.98	6	<b>0 432 131 846</b>	<b>0 986 430 274</b>
					Mot.Nr. 5333534 SSS→	04.95-08.98	6	<b>0 432 131 825</b>	<b>0 986 430 213</b>
					DSC 11.04	09.91-08.98	6	<b>0 432 131 859</b>	
CSA									
CLB, CLL/CRL [BUS]	11,0		180	DSC 11.71	04.95-08.98	6	<b>0 432 131 825</b>	<b>0 986 430 213</b>	
				DSC 11.27 <EDC>	04.91-08.98	6	<b>0 432 131 825</b>	<b>0 986 430 213</b>	
CLB, CLL/CRL, DRB [BUS]	11,0		191-193	DS 11.78	04.91-08.98	6	<b>0 432 131 825</b>	<b>0 986 430 213</b>	
				DSC 11.24 <EDC>	04.91-08.98	6	<b>0 432 131 789</b>		
CLB, DRB [BUS]	11,0	134	DN 11.06 C	04.91-08.98	6	<b>0 432 292 880</b>			
CLL/CRL [BUS]	11,0	191	DSI 11 E 01	09.91-08.98	6	<b>0 432 231 691</b>			
CR [BUS]	11,0	189	DSC 11.04 C	12.88-08.98	6	<b>0 432 131 859</b>			
DRB [BUS]	11,0	189	DS 11.74 C	04.91-08.98	6	<b>0 432 131 871</b>	<b>0 986 430 120</b>		
<b>P</b>		11,0	229/254/267	DSC 11.03; DSC 11.06; DSC 11.13	05.88-12.00	6	<b>0 432 192 881</b>	<b>0 986 430 034</b>	
			230	DS 11.73	06.88-12.00	6	<b>0 432 292 881</b>	<b>0 986 430 074</b>	
			267	DSC 11.18	01.90-12.91	6	<b>0 432 131 871</b>	<b>0 986 430 120</b>	
<b>P,R</b>	310	11,0	228	DS 11.75					
				Mot.Nr. →5333533 SSS	06.88-05.97	6	<b>0 432 131 846</b>	<b>0 986 430 274</b>	
				Mot.Nr. 5333534 SSS→	01.91-05.97	6	<b>0 432 131 825</b>	<b>0 986 430 213</b>	
	310, 320, 340, 343, 360	11,0	228/236/250/252/265	DS 11.34; DSC 11.08; DSC 11.10;	01.90-05.97	6	<b>0 432 131 871</b>	<b>0 986 430 120</b>	
				DSC 11.17; DSC 11.30					
	313	11,0	230	DS 11.73	05.88-02.95	6	<b>0 432 292 881</b>	<b>0 986 430 074</b>	
	320, 343, 360	11,0	235/252/265	DSC 11.12; DSC 11.13; DSC 11.16	05.88-02.95	6	<b>0 432 192 881</b>	<b>0 986 430 034</b>	
	320, 350, 360	11,0	236/258/265	DSC 11.35; DSC 11.36; DSC 11.39	06.88-05.97	6	<b>0 432 131 846</b>	<b>0 986 430 274</b>	
				<Euro 1>					
	320, 360	11,0	235	DSC 11.21 <Euro 1>					
				Mot.Nr. →5333533 SSS	11.91-05.97	6	<b>0 432 131 846</b>	<b>0 986 430 274</b>	
				Mot.Nr. 5333534 SSS→	11.91-05.97	6	<b>0 432 131 825</b>	<b>0 986 430 213</b>	
	360	11,0	265	DSC 11.18	11.91-05.97	6	<b>0 432 131 871</b>	<b>0 986 430 120</b>	
				DSC 11.23 <Euro 1>	11.91-05.97	6	<b>0 432 131 846</b>	<b>0 986 430 274</b>	
400	11,0	295	DTC 11.01 <Euro I>; DTC 11.02 <Euro 2>	03.92-05.97	6	<b>0 432 131 825</b>	<b>0 986 430 213</b>		
<b>R</b>		11,0	228/267	DS 11.34; DSC 11.18	01.90-05.97	6	<b>0 432 131 871</b>	<b>0 986 430 120</b>	
			229/254	DSC 11.03; DSC 11.06	05.88-05.97	6	<b>0 432 192 881</b>	<b>0 986 430 034</b>	
			230	DS 11.73	06.88-05.97	6	<b>0 432 292 881</b>	<b>0 986 430 074</b>	







R		11,0	267	DSC 11.13	06.88-05.97	6	<b>0 432 192 881</b>	<b>0 986 430 034</b>
			280	DSC 11.22 <Euro 1>	01.91-05.97	6	<b>0 432 131 825</b>	<b>0 986 430 213</b>
				DSC 11.70	06.88-05.97	6	<b>0 432 131 825</b>	<b>0 986 430 213</b>
	203	11,0	149	DN 11.08	10.91-12.98	6	<b>0 432 131 871</b>	<b>0 986 430 120</b>
T	, 313	11,0	230-230	DS 11.73	05.88-05.97	6	<b>0 432 292 881</b>	<b>0 986 430 074</b>
					05.88-05.00	6	<b>0 432 292 881</b>	<b>0 986 430 074</b>
	215	11,0	158	DN 11.01	05.88-05.00	6	<b>0 432 292 880</b>	
	310	11,0	228	DS 11.34	01.90-05.97	6	<b>0 432 131 871</b>	<b>0 986 430 120</b>
	320	11,0	235	DSC 11.16	05.88-05.00	6	<b>0 432 192 881</b>	<b>0 986 430 034</b>
				DSC 11.17	11.91-02.95	6	<b>0 432 131 871</b>	<b>0 986 430 120</b>
				DSC 11.21 <Euro 1>				
				Mot.Nr. →5333533 SSS	11.91-05.00	6	<b>0 432 131 846</b>	<b>0 986 430 274</b>
				Mot.Nr. 5333534 SSS→	11.91-05.00	6	<b>0 432 131 825</b>	<b>0 986 430 213</b>
	320, 360	11,0	236/265	DSC 11.35; DSC 11.36	06.88-05.00	6	<b>0 432 131 846</b>	<b>0 986 430 274</b>
	340	11,0	252	DSC 11.12	05.88-05.89	6	<b>0 432 192 881</b>	<b>0 986 430 034</b>
	360	11,0	265	DS 11.75				
				Mot.Nr. →5333533 SSS	06.88-02.95	6	<b>0 432 131 846</b>	<b>0 986 430 274</b>
				Mot.Nr. 5333534 SSS→	01.91-02.95	6	<b>0 432 131 825</b>	<b>0 986 430 213</b>
				DSC 11.18	01.90-05.00	6	<b>0 432 131 871</b>	<b>0 986 430 120</b>
			265/267	DSC 11.13	05.88-05.97	6	<b>0 432 192 881</b>	<b>0 986 430 034</b>
					05.88-05.00	6	<b>0 432 192 881</b>	<b>0 986 430 034</b>
	360 AU	11,0	265	DSC 11.18	06.88-05.97	6	<b>0 432 131 871</b>	<b>0 986 430 120</b>
	360, 360 AU	11,0	265	DSC 11.23 <Euro 1>	11.91-05.00	6	<b>0 432 131 846</b>	<b>0 986 430 274</b>
	384	11,0	280	DSC 11.22 <Euro 1>	01.91-05.00	6	<b>0 432 131 825</b>	<b>0 986 430 213</b>

**Serie 114**

K	EB, IB [BUS]	11,6	265	DC 11.07 <Euro 2>	08.97-12.03	6	<b>F 000 439 012</b>	
P,R	320, 360	11,0	235/265	DSC 11.74 <Euro 1>; DSC 11.75 <Euro 1>				
				Mot.Nr. →4119161 SNL	05.96-05.99	6	<b>0 432 131 825</b>	<b>0 986 430 213</b>
	340	11,0	250	DSC 11.79 <Euro 2>	05.96-05.99	6	<b>0 432 131 744</b>	
T	320, 360	11,0	235/265	DSC 11.74 <Euro 1>; DSC 11.75 <Euro 1>				
				Mot.Nr. →4119161 SNL	04.97-05.99	6	<b>0 432 131 825</b>	<b>0 986 430 213</b>
	340	11,0	250	DSC 11.79 <Euro 2>	04.97-05.99	6	<b>0 432 131 744</b>	

**Serie 124**

K	EB, IB [BUS]	12,0	265	DSC 12.02 <Euro 2>				
				Mot.Nr. →5707809 SSS	08.97-02.02	6	<b>0 432 131 758</b>	<b>0 986 430 382</b>
				Mot.Nr. 5707810 SSS→	08.97-02.02	6	<b>0 432 131 703</b>	<b>0 986 430 390</b>
P,R	360	12,0	265	DSC 12.02 <Euro 2>				
				Mot.Nr. →5707809 SSS	09.95-02.02	6	<b>0 432 131 758</b>	<b>0 986 430 382</b>
				Mot.Nr. 5707810 SSS→	09.95-02.02	6	<b>0 432 131 703</b>	<b>0 986 430 390</b>
	400	12,0	294	DSC 12.01 <Euro 2>				
Mot.Nr. →5707809 SSS				09.95-01.00	6	<b>0 432 131 758</b>	<b>0 986 430 382</b>	
Mot.Nr. 5707810 SSS→				09.95-01.00	6	<b>0 432 131 703</b>	<b>0 986 430 390</b>	
T	360	12,0	265	DSC 12.02 <Euro 2>				
				Mot.Nr. →5707809 SSS	09.95-02.02	6	<b>0 432 131 758</b>	<b>0 986 430 382</b>
				Mot.Nr. 5707810 SSS→	09.95-02.02	6	<b>0 432 131 703</b>	<b>0 986 430 390</b>
	400	12,0	294	DSC 12.01 <Euro 2>				
Mot.Nr. →5707809 SSS				03.95-01.00	6	<b>0 432 131 758</b>	<b>0 986 430 382</b>	
Mot.Nr. 5707810 SSS→				03.95-01.00	6	<b>0 432 131 703</b>	<b>0 986 430 390</b>	

**Serie 142**

R	388	14,2	285	DS 14.06	01.81-03.88	8	<b>0 432 231 812</b>		
	398	14,2	293	DS 14.07	05.85-03.88	8	<b>0 432 231 812</b>		
	405	14,2	297	DSC 14.06	06.86-03.88	8	<b>0 432 131 873</b>	<b>0 986 430 030</b>	
	410	14,2	301	DSC 14.02	06.85-03.88	CSA	6	<b>0 432 231 799</b>	<b>0 986 430 039</b>
	420	14,2	309	DSC 14.01	10.82-03.88	CSA	8	<b>0 432 231 799</b>	<b>0 986 430 039</b>
	430	14,2	318	DSC 14.05	05.80-03.88	8	<b>0 432 131 873</b>	<b>0 986 430 030</b>	
T	385, 388	14,2	283/285	DS 14.01; DS 14.06	01.81-03.88	8	<b>0 432 231 812</b>		
	398	14,2	293	DS 14.07	06.85-03.88	8	<b>0 432 231 812</b>		
	410	14,2	301	DSC 14.02	06.85-03.88	CSA	8	<b>0 432 231 799</b>	<b>0 986 430 039</b>
	410, 430	14,2	301/318	DSC 14.05; DSC 14.06	06.85-03.88	8	<b>0 432 131 873</b>	<b>0 986 430 030</b>	
	420	14,2	309-317	DSC 14.01	10.82-03.88	CSA	8	<b>0 432 231 799</b>	<b>0 986 430 039</b>





◀ SCANIA

Serie 143									
R	405	14,2	297	DSC 14.06	05.88-12.94		8	0 432 131 873	0 986 430 030
	420, 450, 500	14,2	309/333/368	DSC 14.08 <Euro I>; DSC 14.09 <Euro 1>; DSC 14.10 <Euro I>; DSC 14.16 <Euro 2>	01.91-12.96		8	0 432 131 824	0 986 430 212
	450	14,2	331	DSC 14.03	05.88-12.94 10.96-06.98		8	0 432 131 873	0 986 430 030
	470	14,2	346	DSC 14.04 <EDC>	03.88-05.91		8	0 432 131 873	0 986 430 030
T	405, 450	14,2	297/331	DSC 14.03; DSC 14.06	05.88-12.96		8	0 432 131 873	0 986 430 030
	420, 500	14,2	309/368	DSC 14.08 <Euro 1>; DSC 14.09 <Euro 1>	06.88-12.96		8	0 432 131 824	0 986 430 212
	450, 500	14,2	333/368	DSC 14.10 <Euro I>; DSC 14.16 <Euro 2>	06.92-12.96		8	0 432 131 824	0 986 430 212
	470	14,2	346	DSC 14.04 <EDC>	11.89-12.96		8	0 432 131 873	0 986 430 030
Serie 144									
R	460	14,2	338	DSC 14.15 <Euro 2>	09.96-08.01		8	0 432 131 751	0 986 430 387
				Mot.Nr. →5563229 SSS	09.96-08.01		8	0 432 131 712 <sup>1</sup>	
				Mot.Nr. 5563230 SSS→	09.96-08.01		8	0 432 131 712 <sup>1</sup>	
	530	14,2	389	DSC 14.13 <Euro 2>	01.96-08.01		8	0 432 131 773	0 986 430 385
				Mot.Nr. →5563229 SSS	01.96-08.01		8	0 432 131 713 <sup>1</sup>	
				Mot.Nr. 55632230 SSS→	01.96-08.01		8	0 432 131 713 <sup>1</sup>	
T	460	14,2	338	DSC 14.15 <Euro 2>	02.97-08.01		8	0 432 131 751	0 986 430 387
				Mot.Nr. →5563229 SSS	02.97-08.01		8	0 432 131 712 <sup>1</sup>	
				Mot.Nr. 5563230 SSS→	02.97-08.01		8	0 432 131 712 <sup>1</sup>	
	530	14,2	390	DSC 14.13 <Euro 2>	02.97-08.01		8	0 432 131 773	0 986 430 385
				Mot.Nr. →5563229 SSS	02.97-08.01		8	0 432 131 713 <sup>1</sup>	
				Mot.Nr. 55632230 SSS→	02.97-08.01		8	0 432 131 713 <sup>1</sup>	

**SETRA**

ComfortClass 400									
S415 GT		12,0	185-300	OM 457.941 hLA <Euro 3>					
				Komp.Nr. 522003/02	02.03→	TNK	6	0 432 191 263	
				Komp.Nr. 522003/09					
				Komp.Nr. 522003/08	02.03→	TNK	6	0 432 191 347	
	GT-HD	12,0	260-310	OM 457.944 hLA <Euro 3>					
				Komp.Nr. 522003/02	02.03→	TNK	6	0 432 191 263	
				Komp.Nr. 522003/09					
				Komp.Nr. 522003/08	02.03→	TNK	6	0 432 191 347	
S416 GT-HD		12,0	310	OM 457.944 hLA <Euro 3>					
				Komp.Nr. 522003/02	02.03→	TNK	6	0 432 191 263	
				Komp.Nr. 522003/09					
				Komp.Nr. 522003/08	02.03→	TNK	6	0 432 191 347	
S417 GT-HD		12,0	260-310	OM 457.944 hLA <Euro 3>					
				Komp.Nr. 522003/02	02.03→	TNK	6	0 432 191 263	
				Komp.Nr. 522003/09					
				Komp.Nr. 522003/08	02.03→	TNK	6	0 432 191 347	
MultiClass 300									
S313 UL		12,0	185	OM 457 HLA <Euro 3>	07.01-09.05		6	0 432 191 384	
S315 H, NF, UL		12,0	185/220	OM 457 HLA <Euro 3>	07.01-09.05		6	0 432 191 384	
S316 UL		12,0	185	OM 457 HLA <Euro 3>	07.01-09.05		6	0 432 191 384	
S317 HDH		14,6	280	OM 442 LA <Euro 2>					
				Mot.Nr. →860061	10.97-03.05		8	0 432 131 800	0 986 430 264
				Mot.Nr. 860062→	10.97-03.05		8	0 432 131 803 <sup>1</sup>	
				Mot.Nr. 860062→	10.97-03.05		8	0 432 131 728	0 986 430 327
				Mot.Nr. 860062→	10.97-03.05		8	0 432 131 729 <sup>1</sup>	
			320	OM 442 LA <Euro 2>					
				Mot.Nr. →860061	10.97-03.05		8	0 432 131 801	0 986 430 265
				Mot.Nr. 860062→	10.97-03.05		8	0 432 131 804 <sup>1</sup>	
				Mot.Nr. 860062→	10.97-03.05		8	0 432 131 726	0 986 430 326
				Mot.Nr. 860062→	10.97-03.05		8	0 432 131 730 <sup>1</sup>	
	UL	12,0	185	OM 457 HLA <Euro 3>	07.01-09.05		6	0 432 191 384	





<b>S 319 NF</b>	12,0	184	OM 457 hLA <Euro 3>	12.97-03.05	6	<b>0 432 131 780</b> <sup>1</sup>	
					6	<b>0 432 131 781</b>	<b>0 986 430 361</b>
NF, UL	12,0	185	OM 457 HLA <Euro 3>	07.01-09.05	6	<b>0 432 191 384</b>	
<b>SG 321 UL</b>	12,0	220	OM 457 HLA <Euro 3>	07.01-09.05	6	<b>0 432 191 384</b>	
<b>Setra</b>							
<b>S 215 HDH</b>	14,6	280	OM 442 LA				
			Mot.Nr. →860061	06.96-06.01	8	<b>0 432 131 800</b>	<b>0 986 430 264</b>
					8	<b>0 432 131 803</b> <sup>1</sup>	
			Mot.Nr. 860062→	06.96-06.01	8	<b>0 432 131 728</b>	<b>0 986 430 327</b>
					8	<b>0 432 131 729</b> <sup>1</sup>	
		320	OM 442 LA				
			Mot.Nr. →860061	06.96-06.01	8	<b>0 432 131 801</b>	<b>0 986 430 265</b>
					8	<b>0 432 131 804</b> <sup>1</sup>	
			Mot.Nr. 860062→	06.96-06.01	8	<b>0 432 131 726</b>	<b>0 986 430 326</b>
					8	<b>0 432 131 730</b> <sup>1</sup>	
<b>S 313 UL</b>	12,0	184/220	OM 447 hLA <Euro 2>	03.95-09.05	6	<b>0 432 131 780</b> <sup>1</sup>	
					6	<b>0 432 131 781</b>	<b>0 986 430 361</b>
<b>S 315 GT</b>	14,6	280	OM 442 LA <Euro 2>				
			Mot.Nr. →860061	03.95-03.05	6	<b>0 432 131 800</b>	<b>0 986 430 264</b>
					6	<b>0 432 131 803</b> <sup>1</sup>	
			Mot.Nr. 860062→	03.95-03.05	6	<b>0 432 131 728</b>	<b>0 986 430 327</b>
					6	<b>0 432 131 729</b> <sup>1</sup>	
GT-HD	11,0	320	OM 442 LA <Euro 2>				
			Mot.Nr. →860061	07.96-03.05	8	<b>0 432 131 801</b>	<b>0 986 430 265</b>
					8	<b>0 432 131 804</b> <sup>1</sup>	
			Mot.Nr. 860062→	07.96-03.05	8	<b>0 432 131 726</b>	<b>0 986 430 326</b>
					8	<b>0 432 131 730</b> <sup>1</sup>	
GT-HD, HD, HDH	14,6	280	OM 442 LA <Euro 2>				
			Mot.Nr. →860061	03.95-03.05	8	<b>0 432 131 800</b>	<b>0 986 430 264</b>
					8	<b>0 432 131 803</b> <sup>1</sup>	
			Mot.Nr. 860062→	03.95-03.05	8	<b>0 432 131 728</b>	<b>0 986 430 327</b>
					8	<b>0 432 131 729</b> <sup>1</sup>	
HD, HDH	14,6	320	OM 442 LA <Euro 2>				
			Mot.Nr. →860061	03.95-07.01	8	<b>0 432 131 801</b>	<b>0 986 430 265</b>
					8	<b>0 432 131 804</b> <sup>1</sup>	
			Mot.Nr. 860062→	03.95-07.01	8	<b>0 432 131 726</b>	<b>0 986 430 326</b>
					8	<b>0 432 131 730</b> <sup>1</sup>	
NF, UL	12,0	184/220	OM 447 hLA <Euro 2>	03.95-03.05	6	<b>0 432 131 780</b> <sup>1</sup>	
					6	<b>0 432 131 781</b>	<b>0 986 430 361</b>
<b>S 316 HDS</b>	14,6	280	OM 442 LA <Euro 2>				
			Mot.Nr. →860061	01.97-03.05	8	<b>0 432 131 800</b>	<b>0 986 430 264</b>
					8	<b>0 432 131 803</b> <sup>1</sup>	
			Mot.Nr. 860062→	01.97-03.05	8	<b>0 432 131 728</b>	<b>0 986 430 327</b>
					8	<b>0 432 131 729</b> <sup>1</sup>	
<b>S 319 GT-HD</b>	11,0	320	OM 442 LA <Euro 2>				
			Mot.Nr. →860061	07.98-03.05	8	<b>0 432 131 801</b>	<b>0 986 430 265</b>
					8	<b>0 432 131 804</b> <sup>1</sup>	
			Mot.Nr. 860062→	07.98-03.05	8	<b>0 432 131 726</b>	<b>0 986 430 326</b>
					8	<b>0 432 131 730</b> <sup>1</sup>	
UL	12,0	184/220	OM 447 hLA <Euro 2>	03.95-03.05	6	<b>0 432 131 780</b> <sup>1</sup>	
					6	<b>0 432 131 781</b>	<b>0 986 430 361</b>
<b>S 328 DT</b>	14,6	280	OM 442 LA <Euro 2>				
			Mot.Nr. →860061	03.95-03.05	8	<b>0 432 131 800</b>	<b>0 986 430 264</b>
					8	<b>0 432 131 803</b> <sup>1</sup>	
			Mot.Nr. 860062→	03.95-03.05	8	<b>0 432 131 728</b>	<b>0 986 430 327</b>
					8	<b>0 432 131 729</b> <sup>1</sup>	
		320	OM 442 LA <Euro 2>				
			Mot.Nr. →860061	03.95-02.03	8	<b>0 432 131 801</b>	<b>0 986 430 265</b>
					8	<b>0 432 131 804</b> <sup>1</sup>	
			Mot.Nr. 860062→	03.95-02.03	8	<b>0 432 131 726</b>	<b>0 986 430 326</b>
					8	<b>0 432 131 730</b> <sup>1</sup>	





◀ SETRA

<b>S 328 DT</b>	14,6	385	OM 442 LA <Euro 2>				
			Mot.Nr. →860061	03.95-03.05	8	<b>0 432 131 805</b> <sup>1</sup>	
			Mot.Nr. 860062→	03.95-03.05	8	<b>0 432 131 727</b>	<b>0 986 430 325</b>
					8	<b>0 432 131 731</b> <sup>1</sup>	
<b>SG 321 UL</b>	12,0	184/220	OM 447 hLA <Euro 2>	03.95-09.05	6	<b>0 432 131 780</b> <sup>1</sup>	
					6	<b>0 432 131 781</b>	<b>0 986 430 361</b>

**SSANGYONG**

<b>Istana</b>							
<b>2.9 D Van</b>	2,9	70	OM662	01.92-06.03	5	<b>0 432 217 157</b>	<b>0 986 430 197</b>

**STEYR (STEYR-DAIMLER-PUCH AG)**

<b>Pinzgauer</b>							
<b>2.4 D Turbo</b>	2,4	77	NY	10.86-12.96	6	<b>0 432 217 079</b>	<b>0 986 430 080</b>

**Serie 11-18 HU**

<b>SFL 11 HUA 280</b>	11,0	206	9 FUA	10.87→	6	<b>0 432 231 029</b>	
<b>SG 18 HUA 280</b>	11,0	206	9 FUA	07.87→	6	<b>0 432 231 029</b>	
<b>SL 11 HU 250, 11 HUA 280</b>	11,0	184/206	9 FUA	01.84→	6	<b>0 432 231 029</b>	
<b>SS 11 HU 200, 11 HUA 280</b>	11,0	147/206	9 FUA	06.84→	6	<b>0 432 231 029</b>	
<b>8 S</b>							
<b>14</b>	6,6	100	WD 612.04	05.89-06.89	6	<b>0 432 291 640</b>	
			WD 612.61	05.89→	6	<b>0 432 291 649</b>	
<b>18</b>	6,6	130	WD 612.63	05.89→	6	<b>0 432 291 617</b>	
<b>9 S</b>							
<b>14</b>	6,6	100	WD 612.04	05.86-06.86	6	<b>0 432 291 640</b>	
			WD 612.61	06.86→	6	<b>0 432 291 649</b>	
<b>18</b>	6,6	130	WD 612.63,73	04.86-01.88	6	<b>0 432 291 649</b>	
				02.88→	6	<b>0 432 291 617</b>	
<b>10 S</b>							
<b>14</b>	6,6	100	WD 612.04	05.86-06.86	6	<b>0 432 291 640</b>	
			WD 612.61	06.86→	6	<b>0 432 291 649</b>	
<b>18</b>	6,6	130	WD 612.63,73	04.86-01.88	6	<b>0 432 291 649</b>	
				02.88→	6	<b>0 432 291 617</b>	
<b>11 S</b>							
<b>14</b>	6,6	100	WD 612.61	07.89→	6	<b>0 432 291 649</b>	
<b>18</b>	6,6	130	WD 612.63	07.89→	6	<b>0 432 291 617</b>	
<b>12 M</b>							
<b>18</b>	6,6	130	WD 612.74	09.86-01.88	6	<b>0 432 291 649</b>	
				02.88→	6	<b>0 432 291 617</b>	
<b>12 S</b>							
<b>14</b>	6,6	100	WD 612.04	05.86-06.86	6	<b>0 432 291 640</b>	
			WD 612.61	06.86→	6	<b>0 432 291 649</b>	
<b>18</b>	6,6	130	WD 612.63,73	04.86-01.88	6	<b>0 432 291 649</b>	
				02.88→	6	<b>0 432 291 617</b>	
<b>21</b>	6,6	154	WD 612.65,75	04.86-01.88	6	<b>0 432 291 649</b>	
				02.88→	6	<b>0 432 291 617</b>	
<b>13 S</b>							
<b>14</b>	6,6	100	WD 612.61	09.88→	6	<b>0 432 291 649</b>	
<b>18</b>	6,6	130	WD 612.63	09.88→	6	<b>0 432 291 617</b>	
<b>21</b>	6,6	154	WD 612.65,75	07.89→	6	<b>0 432 291 617</b>	
<b>23</b>	6,6	171	WD 612.66	01.91→	6	<b>0 432 291 617</b>	
<b>14 S</b>							
<b>14</b>	6,6	100	WD 612.04	05.86-06.86	6	<b>0 432 291 640</b>	
			WD 612.61	06.86→	6	<b>0 432 291 649</b>	
			WD 612.92	02.88→	6	<b>0 432 291 617</b>	
<b>18</b>	6,6	130	WD 612.63,73	04.86-01.88	6	<b>0 432 291 649</b>	
				02.88→	6	<b>0 432 291 617</b>	
<b>21</b>	6,6	154	WD 612.65,75	04.86-01.88	6	<b>0 432 291 649</b>	
				02.88→	6	<b>0 432 291 617</b>	





<b>15 S</b>							
14	6,6	100	WD 612.92	02.88→	6	0 432 291 617	
18	6,6	130	WD 612.63	02.88→	6	0 432 291 617	
			WD 612.63,73	04.86-01.88	6	0 432 291 649	
				02.88→	6	0 432 291 617	
21	6,6	154	WD 612.65,75	04.86-01.88	6	0 432 291 649	
				02.88→	6	0 432 291 617	
23	6,6	165	WD 612.93	02.88→	6	0 432 291 617	
		170	WD 612.66	01.91→	6	0 432 291 617	
<b>16 S</b>							
18	6,6	130	WD 612.63	04.86-01.88	6	0 432 291 649	
				02.88→	6	0 432 291 617	
			WD 612.63,73	04.86-01.88	6	0 432 291 649	
				02.88→	6	0 432 291 617	
21	6,6	154	WD 612.65,75	04.86-01.88	6	0 432 291 649	
				02.88→	6	0 432 291 617	
		158	WD 612.65	04.86-01.88	6	0 432 291 649	
				02.88→	6	0 432 291 617	
23	6,6	171	WD 612.93				
			Mot.Nr. 09637→	02.88→	6	0 432 291 617	
<b>17 S</b>							
18	6,6	130	WD 612.63	09.88→	6	0 432 291 617	
21	6,6	154	WD 612.65	09.88→	6	0 432 291 617	
23	6,6	171	WD 612.66	01.91→	6	0 432 291 617	
<b>19 S</b>							
24	9,7	175	WD 615.64; WD 615.74	01.88→	6	0 432 191 773	
28	9,7	204	WD 615.63; WD 615.73	01.88→	6	0 432 191 773	
31	9,7	225-228	WD 615.68,98; WD 615.78,98	10.87→	6	0 432 191 817	
34	12,0	240/250	WD 815.64,79; WD 815.67,69	10.87-06.96 CSA	8	0 432 281 699	
37	12,0	270	WD 815.66,76	10.87-06.96	8	0 432 191 817	
<b>22 S</b>							
28	9,7	204	WD 615.63	01.88→	6	0 432 191 773	
31	9,7	225-228	WD 615.68; WD 615.78	10.87→	6	0 432 191 817	
34	12,0	240/250	WD 815.64; WD 815.67,69	10.87-06.96 CSA	8	0 432 281 699	
37	12,0	270	WD 815.66	10.87-06.96	8	0 432 191 817	
<b>26 S</b>							
28	9,7	204	WD 615.63; WD 615.73	01.88→	6	0 432 191 773	
31	9,7	225	WD 615.68; WD 615.78	10.87→	6	0 432 191 817	
34	12,0	240/250	WD 815.64; WD 815.67,69	10.87-06.96 CSA	8	0 432 281 699	
37	12,0	270	WD 815.66,76	10.87-06.96	8	0 432 191 817	
<b>32 S</b>							
28	9,7	204	WD 615.63; WD 615.73	01.88→	6	0 432 191 773	
31	9,7	225-228	WD 615.68; WD 615.78	10.87→	6	0 432 191 817	
34	12,0	240/250	WD 815.64,79; WD 815.67,69	10.87-06.96 CSA	8	0 432 281 699	
37	12,0	270	WD 815.66,76	10.87-06.96	8	0 432 191 817	
<b>33 S</b>							
31	9,7	225-228	WD 615.68	10.87→	6	0 432 191 817	
34	12,0	250	WD 815.67	10.87-06.96 CSA	8	0 432 281 699	
<b>591</b>							
.136	6,6	100	WD 612.01	02.82-02.86	6	0 432 281 703	
<b>691</b>							
.136	6,6	100	WD 612.01	02.82-02.86	6	0 432 281 703	
<b>791</b>							
.145	6,6	107	WD 612.00; WD 612.20	11.78-02.86 CSA	6	0 432 281 812	
.170	6,6	125	WD 612.60; WD 612.70	02.80-02.86	6	0 432 281 703	
.210	6,6	154	WD 612.90	09.82-02.86	6	0 432 281 703	
<b>1891</b>							
.330	12,0	240	WD 815.62,72	07.82-09.87 CSA	8	0 432 281 699	





**TALBOT**

<b>Express</b>						
1.9 D [J 5]	1,9	51	XUD9A	11.87-04.88 BO	4	<b>0 432 217 181</b>
				04.88-12.93 BO	4	<b>0 432 217 201</b>

**TATA (TELCO)**

<b>407</b>						
LPT Turbo	3,0	55	497SP TC BS2	02.02→	4	<b>F 002 C8Z 859</b>
<b>613</b>						
LPT	5,7	95	697 TCIC <Euro 2>	10.04→	6	<b>F 002 C8Z 860</b>
		96	697 TCIC <Euro 3>	01.08→	6	<b>0 432 193 458<sup>1</sup></b>
<b>709</b>						
LPT 3.8 D	3,8	66	497X128 Euro TC	06.94-02.00	4	<b>F 002 C8Z 203</b>
			497X128 TC BS2	12.01→	4	<b>F 002 C8Z 852</b>
			497X128 TC CMVR 2000	02.00→	4	<b>F 002 C8Z 205</b>

**TATRA**

<b>Serie 815</b>						
T 815 2 NT 4x4	12,8	243	BF8L 513 LC <Euro I>	01.92→	8	<b>0 432 291 553</b>
<b>Safir</b>						
	11,9	258	6D24	01.99-08.09	6	<b>9 430 613 898</b>
<b>Tourmalin</b>						
13	12,0	228	D2866 LUH24 <Euro 3>	01.05→	6	<b>0 432 191 419</b>

**URAL AUTOMOBIL PLANT**

<b>33t</b>						
6329	13,8	272	8210.42K <Euro 2>	01.03→	6	<b>0 432 291 516</b>
6529	13,8	272	8210.42K <Euro 2>	01.03→	6	<b>0 432 291 516</b>
<b>88t</b>						
632911	13,8	272	8210.42K <Euro 2>	01.03→	6	<b>0 432 291 516</b>









**VAUXHALL**

<b>Euromidi</b>						
2.0 DT	2,0	51	4 FC1T	09.88-08.96 DKF	4	<b>9 430 610 042</b>
2.2 D	2,2	45	4 FD1	09.88-08.96 DKF	4	<b>9 430 610 150</b>
2.4 DT	2,4	56	4 FG1T	09.88-08.96 DKF	4	<b>9 430 610 149</b>

**VOLVO**

<b>B</b>						
6 F, FA	5,5	132	TD 60 B	11.79-12.87	6	<b>0 432 191 870</b>
7 F	6,7	210	D7A285	01.99→	6	<b>0 432 191 634 0 986 430 368</b>
F, FA	6,7	157	TD 70 H	10.83-12.87	6	<b>0 432 191 854 0 986 430 002</b>
L	7,0	158/184/ 202/213/ 228	D7C	05.99→	EC9	6 <b>0 432 191 537</b>
						6 <b>0 432 193 536<sup>1</sup></b>
					E96	6 <b>0 432 191 466<sup>1</sup></b>
						6 <b>0 432 191 506 0 986 430 591</b>
					SFZ	6 <b>0 432 193 572<sup>1</sup></b>
						6 <b>0 432 193 676</b>
10 , M	9,6	180	THD 103 KF	01.92-01.96	6	<b>0 432 191 719 0 986 430 359</b>
				01.92-01.97	6	<b>0 432 191 719 0 986 430 359</b>



										
10 , M	9,6	210	THD 103 KB	01.92-01.96	6	0 432 191 719	0 986 430 359			
				01.92-01.97	6	0 432 191 719	0 986 430 359			
	B, BLE	10,0		250 THD 103 KD	01.92-01.96	6	0 432 191 710	0 986 430 366		
					01.92-01.97	6	0 432 191 710	0 986 430 366		
				THD101GC; THD101GD	01.92-01.96	6	0 432 191 815	0 986 430 164		
				THD102KB						
				Mot.Nr. 59769→	01.92-01.96	6	0 432 191 737	0 986 430 353		
				Mot.Nr. →59768	01.92-01.96	6	0 432 191 770	0 986 430 165		
				THD102KD						
				Mot.Nr. 59769→	01.92-01.96	6	0 432 191 737	0 986 430 353		
Mot.Nr. →59768	01.92-01.96	6	0 432 191 770	0 986 430 165						
L, M	9,6	180/210/265	THD102KF							
			Mot.Nr. 59769→	01.92-01.96	6	0 432 191 737	0 986 430 353			
			Mot.Nr. →59768	01.92-01.96	6	0 432 191 770	0 986 430 165			
			THD103KB; THD103KF	01.92-01.96	6	0 432 191 719	0 986 430 359			
			THD103KD	01.92-01.96	6	0 432 191 710	0 986 430 366			
			THD104KB; THD104KF	01.92-01.96	6	0 432 191 635				
			180/210/265 DH10A	01.92-01.96	6	0 432 191 612	0 986 430 369			
			L, M							
M	9,6	133/160	THD 100 EA	10.80-10.86	6	0 432 191 848	0 986 430 000			
			THD 100 EB	10.80-10.86	6	0 432 191 848	0 986 430 000			
			M, R	9,6	250/257/265	THD 101 GB; THD 101 GC; THD 101 GD;	06.86-01.96	6	0 432 191 815	0 986 430 164
THD 101 KB; THD 101 KC; THD 101 KE										
202/210/228/235										
179/212	THD 100 EE; THD 100 EK	10.80-10.86				6	0 432 191 848	0 986 430 000		
R	9,6	160/180	THD 100 EC	10.80-10.86	6	0 432 191 848	0 986 430 000			
12	9,6	250/257/265	THD 102 KA							
			Mot.Nr. →59768	05.88-01.96	6	0 432 191 770	0 986 430 165			
			Mot.Nr. 59769→63644	05.88-01.96	6	0 432 191 737	0 986 430 353			
			THD 102 KF							
			Mot.Nr. →59768	05.88-01.96	6	0 432 191 770	0 986 430 165			
			Mot.Nr. 59769→	05.88-01.96	6	0 432 191 737	0 986 430 353			
M, R	9,6	250/257/265	THD 100 ED	10.80-10.86	6	0 432 191 848	0 986 430 000			
R	9,6	160/180	THD 102 KB							
			Mot.Nr. →59768	05.88-01.96	6	0 432 191 770	0 986 430 165			
			Mot.Nr. 59769→	05.88-01.96	6	0 432 191 737	0 986 430 353			
			Mot.Nr. 59769→	05.88-01.96	6	0 432 191 770	0 986 430 165			
12	12,0	262/291/262/298	THD 102 KD							
			Mot.Nr. →59768	05.88-01.96	6	0 432 191 770	0 986 430 165			
			Mot.Nr. 59769→63644	05.88-01.96	6	0 432 191 737	0 986 430 353			
			Mot.Nr. 63645→	05.88-01.96	6	0 432 191 770	0 986 430 165			
BB	57	6,7	143/157	THD 100 EB	11.83-01.96	6	0 432 191 848	0 986 430 000		
				THD 100 EC	05.86-01.96	6	0 432 191 848	0 986 430 000		
C	10 M	9,6	203	TD 122 FH <Euro I>; TD 122 FL	09.91-10.95	6	0 432 191 788	0 986 430 167		
				TD 123 E <Euro I, EDC>; TD 123 ES <Euro I, EDC>	06.92-10.95	6	0 432 191 721	0 986 430 250		
CH	230	12,0	243	TD 70 H; TD 70 HA						
				Mot.Nr. 123551→	08.80-01.96	6	0 432 191 854	0 986 430 002		
C	10 M	9,6	203	THD 101 GD	10.84-08.87	6	0 432 191 848	0 986 430 000		
					09.87-12.87	6	0 432 191 815	0 986 430 164		
CH	230	12,0	243	TD 121 GD	06.84-01.87	6	0 432 191 852			





◀ VOLVO

F										
7	7,0	147-156/	TD 70 F; TD 70 G	07.80-05.88	6	0 432 191 854	0 986 430 002			
		162								
		180	TD 70 FS	CH 07.80-05.88	6	0 432 191 854	0 986 430 002			
				GB 03.84-05.88	6	0 432 191 827				
10	9,6	191/210/	TD 102 FAQ; TD 102 FBQ; TD 102 FDQ;	12.87-12.94	6	0 432 191 770	0 986 430 165			
		221/228/	TD 102 FEQ; TD 102 FH; TD 102 FL;							
		230/232/	TD 102 FM							
		234								
		192-202/	TD 101 F; TD 101 FA; TD 101 G;	10.83-05.88	6	0 432 191 848	0 986 430 000			
	215-220	TD 101 GA								
		210-235	TD 103 E, ES <EDC>	08.91-12.94	6	0 432 191 730	0 986 430 263			
		230-234	TD 102 F	10.87-12.94	6	0 432 191 771	0 986 430 166			
12	12,0	221	TD 122 FTO	08.87-12.94 AA	6	0 432 191 788	0 986 430 167			
				10.91-12.94 AA	6	0 432 191 808				
		224/246/	TD 123 EA <EDC>; TD 123 EB <EDC>;	10.90-12.94	6	0 432 191 737	0 986 430 353			
		270	TD 123 EC <EDC>							
		232	TD 121 FH	06.86-09.91	6	0 432 191 788	0 986 430 167			
		235-243/	TD 121 F; TD 121 FD; TD 121 G;	10.83-12.94	6	0 432 191 863	0 986 430 032			
		272-283	TD 121 GD							
		254	TD 122 FKQ	08.87-12.94 AA	6	0 432 191 788	0 986 430 167			
				10.91-12.94 AA	6	0 432 191 808				
		257	TD 122 F	11.87-12.94 AA	6	0 432 191 788	0 986 430 167			
				10.91-12.94 AA	6	0 432 191 808				
		262	TD 122 FH	01.90-12.94 AA	6	0 432 191 788	0 986 430 167			
				10.91-12.94 AA	6	0 432 191 808				
		262/298/	TD 123 E <EDC, Euro I>; TD 123 ED <EDC>;	01.92-12.94	6	0 432 191 721	0 986 430 250			
		301	TD 123 ES <EDC, Euro I>							
		280	TD 121 FK	09.87-05.88	6	0 432 191 863	0 986 430 032			
		287	TD 122 FAQ	08.87-12.94 AA	6	0 432 191 788	0 986 430 167			
				10.91-12.94 AA	6	0 432 191 808				
				TD 122 FBQ	08.87-12.94 AA	6	0 432 191 788	0 986 430 167		
				10.91-12.94 AA	6	0 432 191 808				
				TD 122 FCQ	08.87-12.94 AA	6	0 432 191 788	0 986 430 167		
				10.91-12.94 AA	6	0 432 191 808				
				TD 122 FK	05.88-12.92	6	0 432 191 863	0 986 430 032		
		TD 122 FR	05.88-12.94	6	0 432 191 863	0 986 430 032				
			AA	6	0 432 191 788	0 986 430 167				
		TD 122 FS <EDC>	11.87-12.94 AA	6	0 432 191 788	0 986 430 167				
			10.91-12.94 AA	6	0 432 191 808					
		291	TD 122 FL	10.89-12.94 AA	6	0 432 191 788	0 986 430 167			
				10.91-12.94 AA	6	0 432 191 808				
		300-310	TD 122 ED	10.91-12.94	6	0 432 291 715	0 986 430 354			
		309	TD 122	10.91-12.94 AA	6	0 432 191 808				
		396	TD 122 FA	08.87-12.94 AA	6	0 432 191 788	0 986 430 167			
				10.91-12.94 AA	6	0 432 191 808				
16	16,0	330-357	TD 162 F,FJ,FL,FS	10.87-12.94	6	0 432 291 635	0 986 430 169			
		357	TD 163 ES <EDC,Euro I>	08.91-12.94	6	0 432 291 562				
406	3,6	80-88	TD 40 A	04.78-02.86	6	0 432 297 032				
407	3,6	80-88	TD 40 A	04.78-02.86	6	0 432 297 032				
408	3,6	80-88	TD 40 A	04.78-02.86	6	0 432 297 032				
409	3,6	88	TD 40 A	12.78-02.86	6	0 432 297 032				
610	5,5	110	TD 60 C	11.80-02.86	6	0 432 191 855				
611	5,5	113	TD 60 C	11.80-02.86	6	0 432 191 855				
612	5,5	108	TD 60 C	04.83-02.86	6	0 432 191 855				
613	5,5	128/132	TD 60 B	11.80-02.86	6	0 432 191 870				
614	5,5	126-132	TD 60 B	11.80-02.86	6	0 432 191 870				
616 S	5,5	132	TD 60 B	02.81-02.86	6	0 432 191 870				
617 S	5,5	132	TD 60 B	12.78-02.86	6	0 432 191 870				
FH										
16 470, 520	16,0	346/382	D 16A470; D 16A520 <Euro 2>; D 16B470; D 16B520 <Euro 2>	08.93-12.02	6	0 432 291 534	0 986 430 301			







FL									
6	180, 220	5,5	132/162	D6B180; D6B220	05.00-05.06	6	0 432 191 405		
	250	5,5	184	D6B250	05.00-05.06	6	0 432 191 460	0 986 430 592	
7		6,7	169	D 7 B230 <Euro 2>					
				Mot.Nr. →77798	10.94-10.99	6	0 432 191 634	0 986 430 368	
				Mot.Nr. 77799→	10.94-10.99	6	0 432 191 634	0 986 430 368	
			191/210	D 7 A285 <Euro 2>; D 7 B260 <Euro 2>	12.93-10.99	6	0 432 191 634	0 986 430 368	
		7,0	160/184	TD 73 EA; TD 73 EB	10.90-10.99	6	0 432 191 736	0 986 430 363	
			169-173/ 178-184	TD 71 F, FQ; TD 71 FD; TD 71 FS, FSQ	09.85-10.94	6	0 432 191 825	0 986 430 163	
10		9,6	202/220	TD 101 F; TD 101 G	09.85-12.93	6	0 432 191 848	0 986 430 000	
			209/230/ 234	TD 102 FH; TD 102 FL; TD 102 FM	09.85-12.93	6	0 432 191 770	0 986 430 165	
			210/236	TD 103 E; TD 103 EA; TD 103 ES	11.92-02.96	6	0 432 191 730	0 986 430 263	
			220	TD 101 FA	12.86-12.93	6	0 432 191 848	0 986 430 000	
			221/222	TD 101 FC; TD 101 FD	12.86-12.93	6	0 432 191 815	0 986 430 164	
			228/235/ 258/265	D 10A 310; D 10A 320; D 10A 350; D 10A 360	02.95-12.01	6	0 432 191 612	0 986 430 369	
			230-234	TD 102 F; TD 102 FDQ	09.85-12.93	6	0 432 191 771	0 986 430 166	
408		3,6	82-91	TD 41 G	02.86-12.95	6	0 432 191 795		
608		5,5	108/112	TD 61 G; TD 61 GA	09.86-11.94	6	0 432 191 822	0 986 430 162	
			132/154	TD 63 E <Euro 1>; TD 63 ES <Euro 1>	11.91-12.96	6	0 432 191 724	0 986 430 311	
610		5,5	112-113	TD 61 G <3012>	09.85-11.94	6	0 432 191 822	0 986 430 162	
611		5,5	112-113/ 126/ 131-132/ 150-152	TD 61 F <3012>; TD 61 G <3012>; TD 61 GA; TD 61 GB; TD 61 GC; TD 61 GS <3012>	09.85-11.94	6	0 432 191 822	0 986 430 162	
			132/154	TD 63 E <Euro 1>; TD 63 ES <Euro 1>	11.91-12.96	6	0 432 191 724	0 986 430 311	
612		5,5	131-132	TD 61 GC; TD 61 GS <3012>	09.85-11.94	6	0 432 191 822	0 986 430 162	
			132/154	TD 63 E <Euro 1>; TD 63 ES <Euro 1>	11.91-12.96	6	0 432 191 724	0 986 430 311	
613		5,5	131-132	TD 61 GC; TD 61 GS <3012>	09.85-11.94	6	0 432 191 822	0 986 430 162	
614		5,5	131-132/ 150-152	TD 61 F <3012>; TD 61 GC; TD 61 GS <3012>	09.85-11.94	6	0 432 191 822	0 986 430 162	
			132/154	TD 63 E <Euro 1>; TD 63 ES <Euro 1>	11.91-12.96	6	0 432 191 724	0 986 430 311	
615		5,5	132/154	TD 63 E <Euro 1>; TD 63 ES <Euro 1>	11.91-12.96	6	0 432 191 724	0 986 430 311	
616		5,5	131-132/ 150-152	TD 61 F <3012>; TD 61 GS/GB <3012>	09.85-11.94	6	0 432 191 822	0 986 430 162	
617		5,5	131-132/ 150-152	TD 61 F <3012>; TD 61 GC; TD 61 GS/GB <3012>	09.85-11.94	6	0 432 191 822	0 986 430 162	
618		5,5	132/154	TD 63 E <Euro 1>; TD 63 ES <Euro 1>	11.91-12.96	6	0 432 191 724	0 986 430 311	
619		5,5	150-152	TD 61 F <3012>	09.85-11.94	6	0 432 191 822	0 986 430 162	
FM									
7	250	7,3	184	D 7C250	09.98-12.01	EC9	6	0 432 193 572 <sup>1</sup>	
						E96	6	0 432 193 676	
							6	0 432 191 466 <sup>1</sup>	
							6	0 432 191 506	0 986 430 591
	290	7,3	210	D 7C290	09.98-12.01	EC9	6	0 432 193 572 <sup>1</sup>	
						E96	6	0 432 193 676	
							6	0 432 191 466 <sup>1</sup>	
							6	0 432 191 506	0 986 430 591
	310	7,3	228	D 7C310	09.98-12.01	EC9	6	0 432 193 572 <sup>1</sup>	
						E96	6	0 432 193 676	
							6	0 432 191 466 <sup>1</sup>	
							6	0 432 191 506	0 986 430 591
10	320, 360	9,6	236/265	D 10B320; D 10B360	04.99-12.01		6	0 432 191 612	0 986 430 369
FS									
10		9,6	220	TD 101 FD	01.87-01.89		6	0 432 191 815	0 986 430 164
			234	TD 102 FDQ	09.88-12.95		6	0 432 191 770	0 986 430 165
718		6,7	169/191	D7B230 <Euro 2>; D7B260 <Euro 2>	09.94-03.96		6	0 432 191 634	0 986 430 368





◀ VOLVO

N								
7	6,7	157	TD 70 G	08.80-11.87	6	0 432 191 854	0 986 430 002	
10	250, 260, 300	9,6	185/192/220	TD 101 F; TD 101 G; TD 101 GB	08.83-04.89	6	0 432 191 848	0 986 430 000
	275, 300	10,0	202/221	TD 101 F; TD 101 G	08.83-12.88	6	0 432 191 848	0 986 430 000
12	, 290	12,0	213	TD 120 FA; TD 120 FB	05.83-05.86	6	0 432 191 852	
	280, 315, 330, 350, 370, 380	12,0	206/210/232/243/257/272-283	TD 121 F; TD 121 FA; TD 121 FB; TD 121 FC; TD 121 FD; TD 121 FE; TD 121 FF; TD 121 FG; TD 121 GD	09.83-01.98	6	0 432 191 863	0 986 430 032
	320	12,0	235-243	TD 121 G	09.86-01.96	6	0 432 191 863	0 986 430 032
	330	12,0	243	TD 121 G	S 01.84-12.88	6	0 432 191 863	0 986 430 032
NL								
10	275	9,6	202	TD 101 G	05.91-09.01	6	0 432 191 848	0 986 430 000
				TD 102 F	05.91-09.01	6	0 432 191 771	0 986 430 166
	285, 320	9,6	210/234	TD 102 FH; TD 102 FL	05.91-09.01	6	0 432 191 770	0 986 430 165
	310	9,6	228	TD 102 FT	12.92-12.95	6	0 432 281 815	
	320	9,6	236	TD 103 ES	05.91-09.01	6	0 432 191 730	0 986 430 263
12	320	12,0	235-243	TD 121 G	05.91-09.01	6	0 432 191 863	0 986 430 032
	350, 360, 390, 400	12,0	257-262/287-291	TD 122 F; TD 122 FH; TD 122 FL; TD 122 FS	05.91-09.01	6	0 432 191 788	0 986 430 167
	360, 400	12,0	262/298	TD 123 E; TD 123 ES	05.91-09.01	6	0 432 191 721	0 986 430 250











**VOLZHANIN**

Serie 6000							
6270	9,0	221	DC 9 03 <Euro 3>	01.10→	6	0 432 191 464 <sup>1</sup>	
					6	0 432 191 465	
Serie 32000							
32901	5,7	96	697 TC65 <Euro 3>	01.10→	6	F 002 C7Z 261	
					6	0 432 193 458 <sup>1</sup>	

**VW (VOLKSWAGEN)**

B								
16	.180 CO	6,0	135	6.10 TCA	03.93-12.93	6	9 430 082 745	
					01.94-09.95	6	9 430 082 752	
					10.95-06.97	6	9 430 082 769	
Bus								
1.6	D [24, 25]	1,6	37	CS	08.84-07.87	4	0 432 217 083	0 986 430 081
						4	0 432 217 084	0 986 430 081
	D Turbo, D Turbo Syncro [24, 25]	1,6	51	JX	08.84-07.92	4	0 432 217 079	0 986 430 080
1.7	D [24, 25]	1,7	42	KY	10.86-07.92	4	0 432 217 083	0 986 430 081
						4	0 432 217 084	0 986 430 081
California T4								
1.9	D [70, 7D]	1,9	45	1X	09.90-04.97	4	0 432 217 207	0 986 430 189
	D Turbo [70, 7D]	1,9	50	ABL	10.92-06.03	4	0 432 217 242	0 986 430 188
2.4	D, D Syncro [70, 7D]	2,4	55/57	AAB; AJA	09.90-06.03	5	0 432 217 207	0 986 430 189
2.5	TDI [70, 7D]	2,5	65	AYY	10.01-06.03	5	0 432 193 619 <sup>1</sup>	
						5	0 432 193 662	
			75	AUF	05.99-06.03	AG	5	0 432 193 619 <sup>1</sup>
						GS	5	0 432 193 621 <sup>1</sup>
				Fg.Nr. →70...2..075 000	05.99-10.01	5	0 432 193 823	
				Fg.Nr. 70...2..075 000→	11.01-06.03	5	0 432 193 662	
			AYC	04.01-06.03	AG	5	0 432 193 619 <sup>1</sup>	
					GS	5	0 432 193 621 <sup>1</sup>	
				Fg.Nr. →70...2..075 000	04.01-10.01	5	0 432 193 823	
				Fg.Nr. 70...2..075 000→	11.01-06.03	5	0 432 193 662	
			111	AHY	05.98-09.00	5	0 432 193 608 <sup>1</sup>	
						5	0 432 193 669	



									
2.5 TDI [70, 7D]	2,5	111	AXG		09.00-06.03		5	0 432 193 550 <sup>1</sup>	
							5	0 432 193 552	
TDI Syncro [70, 7D]	2,5	75	AXL		04.01-06.03		5	0 432 193 621 <sup>1</sup>	
							5	0 432 193 823	
TDI, TDI Syncro [70, 7D]	2,5	75	ACV		01.95-06.03	AG	5	0 432 193 619 <sup>1</sup>	
						GS	5	0 432 193 621 <sup>1</sup>	
				Fg.Nr. →70..2..075 000	01.95-10.01	AG	5	0 432 193 662	
						GS	5	0 432 193 823	
				Fg.Nr. 70..2..075 000→	11.01-06.03		5	0 432 193 662	
<b>Caravelle T4</b>									
1.9 D [70, 7D]	1,9	45	1X		10.90-04.97		4	0 432 217 207	0 986 430 189
D Turbo [70, 7D]	1,9	50	ABL		10.92-06.03		4	0 432 217 242	0 986 430 188
2.4 D, D Syncro [70, 7D]	2,4	55/57	AAB; AJA		09.90-06.03		5	0 432 217 207	0 986 430 189
2.5 TDI [70, 7D]	2,5	65	AYY		10.01-06.03		5	0 432 193 619 <sup>1</sup>	
							5	0 432 193 662	
		75	AUF		05.99-06.03	AG	5	0 432 193 619 <sup>1</sup>	
						GS	5	0 432 193 621 <sup>1</sup>	
				Fg.Nr. →70..2..075 000	05.99-10.01		5	0 432 193 823	
				Fg.Nr. 70..2..075 000→	11.01-06.03		5	0 432 193 662	
			AYC		04.01-06.03	AG	5	0 432 193 619 <sup>1</sup>	
						GS	5	0 432 193 621 <sup>1</sup>	
				Fg.Nr. →70..2..075 000	04.01-10.01		5	0 432 193 823	
				Fg.Nr. 70..2..075 000→	11.01-06.03		5	0 432 193 662	
		111	AHY		05.98-09.00		5	0 432 193 608 <sup>1</sup>	
							5	0 432 193 669	
			AXG		09.00-06.03		5	0 432 193 550 <sup>1</sup>	
							5	0 432 193 552	
TDI Syncro [70, 7D]	2,5	75	AXL		04.01-06.03		5	0 432 193 621 <sup>1</sup>	
							5	0 432 193 823	
TDI, TDI Syncro [70, 7D]	2,5	75	ACV		01.95-06.03	AG	5	0 432 193 619 <sup>1</sup>	
						GS	5	0 432 193 621 <sup>1</sup>	
				Fg.Nr. →70..2..075 000	01.95-10.01	AG	5	0 432 193 662	
						GS	5	0 432 193 823	
				Fg.Nr. 70..2..075 000→	11.01-06.03		5	0 432 193 662	
<b>Eurovan</b>									
2.4 D [70]	2,4	57	AAB		10.92-04.97		5	0 432 217 207	0 986 430 189
<b>L</b>									
80	4,0	103	4.10 TCA <Euro 2>		08.96-12.96	TW	4	9 430 082 752	
					08.96-10.97	TW	4	9 430 082 759	
<b>LT</b>									
28 2.4 D [28, 29, 21]	2,4	51	ACT						
				Fg.Nr. →21..P..022 900	08.92-04.93		6	0 432 217 240	0 986 430 187
				Fg.Nr. 21..P..022 901→	04.93-04.96		6	0 432 217 272	0 986 430 187
			1S		08.89-07.92		6	0 432 217 207	0 986 430 189
		55	DW		12.82-07.92		6	0 432 217 084	0 986 430 081
2.4 D Turbo [28, 29, 21]	2,4	68/75	DV; 1G		12.82-08.92		6	0 432 217 079	0 986 430 080
		70	ACL		09.92-04.96		6	0 432 217 232	
2.5 SDI [2D, 2H]	2,5	55	AGX						
				Fg.Nr. →2D..X..027 000	05.96-01.99		5	0 432 193 617 <sup>1</sup>	
							5	0 432 193 716	
				Fg.Nr. 2D..X..027 001→	02.99-04.01		5	0 432 193 621 <sup>1</sup>	
							5	0 432 193 823	
2.5 TDI [2D, 2H]	2,5	61	BBE		04.01-04.06		5	0 432 193 621 <sup>1</sup>	
							5	0 432 193 823	
		66/75	AHD; APA		05.96-04.01		5	0 432 193 621 <sup>1</sup>	
							5	0 432 193 823	
		70	BBF		04.01-04.06		5	0 432 193 621 <sup>1</sup>	
							5	0 432 193 823	
		80	ANJ		05.99-04.06		5	0 432 193 619 <sup>1</sup>	
							5	0 432 193 662	
			AVR		12.02-04.06		5	0 432 193 508 <sup>1</sup>	
							5	0 432 193 510	
2.8 D Turbo [2D, 2H]	2,8	92/96	AGK; ATA		07.97-01.02		4	0 432 193 731	





◀ VW

<b>31</b>	2.4 D [28, 29, 21]	2,4	51	ACT					
					Fg.Nr. →21..P..022 900	08.92-04.93	6	<b>0 432 217 240</b>	<b>0 986 430 187</b>
					Fg.Nr. 21..P..022 901→	04.93-04.96	6	<b>0 432 217 272</b>	<b>0 986 430 187</b>
				1S	08.89-07.92	6	<b>0 432 217 207</b>	<b>0 986 430 189</b>	
			55	DW	12.82-07.92	6	<b>0 432 217 084</b>	<b>0 986 430 081</b>	
	2.4 D Turbo [28, 29, 21]	2,4	68/75	DV; 1G	12.82-08.92	6	<b>0 432 217 079</b>	<b>0 986 430 080</b>	
			70	ACL	09.92-04.96	6	<b>0 432 217 232</b>		
<b>35</b>	2.4 D [28, 29, 21]	2,4	51	ACT					
					Fg.Nr. →21..P..022 900	08.92-04.93	6	<b>0 432 217 240</b>	<b>0 986 430 187</b>
					Fg.Nr. 21..P..022 901→	04.93-04.96	6	<b>0 432 217 272</b>	<b>0 986 430 187</b>
				1S	08.89-07.92	6	<b>0 432 217 207</b>	<b>0 986 430 189</b>	
			55	DW	12.82-07.92	6	<b>0 432 217 084</b>	<b>0 986 430 081</b>	
	2.4 D Turbo [28, 29, 21]	2,4	68/75	DV; 1G	12.82-08.92	6	<b>0 432 217 079</b>	<b>0 986 430 080</b>	
			70	ACL	09.92-04.96	6	<b>0 432 217 232</b>		
	2.5 SDI [2D, 2H]	2,5	55	AGX					
					Fg.Nr. →2D..X..027 000	05.96-01.99	5	<b>0 432 193 617<sup>1</sup></b>	
							5	<b>0 432 193 716</b>	
					Fg.Nr. 2D..X..027 001→	02.99-04.01	5	<b>0 432 193 621<sup>1</sup></b>	
							5	<b>0 432 193 823</b>	
	2.5 TDI [2D, 2H]	2,5	61	BBE		04.01-04.06	5	<b>0 432 193 621<sup>1</sup></b>	
							5	<b>0 432 193 823</b>	
			66/75	AHD; APA		05.96-04.01	5	<b>0 432 193 621<sup>1</sup></b>	
							5	<b>0 432 193 823</b>	
			70	BBF		04.01-04.06	5	<b>0 432 193 621<sup>1</sup></b>	
							5	<b>0 432 193 823</b>	
			80	ANJ		05.99-04.06	5	<b>0 432 193 619<sup>1</sup></b>	
							5	<b>0 432 193 662</b>	
				AVR		12.02-04.06	5	<b>0 432 193 508<sup>1</sup></b>	
							5	<b>0 432 193 510</b>	
	2.8 D Turbo [2D, 2H]	2,8	92/96	AGK; ATA		07.97-01.02	4	<b>0 432 193 731</b>	
<b>40</b>	2.4 D [28, 29, 21]	2,4	51	ACT					
					Fg.Nr. →21..P..022 900	08.92-04.93	6	<b>0 432 217 240</b>	<b>0 986 430 187</b>
					Fg.Nr. 21..P..022 901→	04.93-04.96	6	<b>0 432 217 272</b>	<b>0 986 430 187</b>
				1S	08.89-07.92	6	<b>0 432 217 207</b>	<b>0 986 430 189</b>	
			55	DW	12.82-07.92	6	<b>0 432 217 084</b>	<b>0 986 430 081</b>	
	2.4 D Turbo [28, 29, 21]	2,4	68/75	DV; 1G	12.82-08.92	6	<b>0 432 217 079</b>	<b>0 986 430 080</b>	
			70	ACL	09.92-04.96	6	<b>0 432 217 232</b>		
	2.4 D Turbo 4x4 [29, 21]	2,4	75	DV	09.85-08.92	6	<b>0 432 217 079</b>	<b>0 986 430 080</b>	
	2.4 D 4x4 [29, 21]	2,4	55	DW	09.85-07.92	6	<b>0 432 217 084</b>	<b>0 986 430 081</b>	
<b>45</b>	2.4 D [28, 29, 21]	2,4	51	ACT					
					Fg.Nr. →21..P..022 900	08.92-04.93	6	<b>0 432 217 240</b>	<b>0 986 430 187</b>
					Fg.Nr. 21..P..022 901→	04.93-04.96	6	<b>0 432 217 272</b>	<b>0 986 430 187</b>
				55	DW	12.82-07.92	6	<b>0 432 217 084</b>	<b>0 986 430 081</b>
	2.4 D Turbo [28, 29, 21]	2,4	70	ACL	09.92-04.96	6	<b>0 432 217 232</b>		
			75	DV	12.82-08.92	6	<b>0 432 217 079</b>	<b>0 986 430 080</b>	
	2.4 D Turbo 4x4 [29, 21]	2,4	75	DV	09.85-08.92	6	<b>0 432 217 079</b>	<b>0 986 430 080</b>	
	2.4 D 4x4 [29, 21]	2,4	55	DW	09.85-07.92	6	<b>0 432 217 084</b>	<b>0 986 430 081</b>	
<b>46</b>	2.5 SDI [2D, 2H]	2,5	55	AGX					
					Fg.Nr. →2D..X..027 000	05.96-01.99	5	<b>0 432 193 617<sup>1</sup></b>	
							5	<b>0 432 193 716</b>	
					Fg.Nr. 2D..X..027 001→	02.99-04.01	5	<b>0 432 193 621<sup>1</sup></b>	
							5	<b>0 432 193 823</b>	
	2.5 TDI [2D, 2H]	2,5	61	BBE		04.01-04.06	5	<b>0 432 193 621<sup>1</sup></b>	
							5	<b>0 432 193 823</b>	
			66/75	AHD; APA		05.96-04.01	5	<b>0 432 193 621<sup>1</sup></b>	
							5	<b>0 432 193 823</b>	
			70	BBF		04.01-04.06	5	<b>0 432 193 621<sup>1</sup></b>	
							5	<b>0 432 193 823</b>	
			80	ANJ		05.99-04.06	5	<b>0 432 193 619<sup>1</sup></b>	
							5	<b>0 432 193 662</b>	
				AVR		12.02-04.06	5	<b>0 432 193 508<sup>1</sup></b>	
							5	<b>0 432 193 510</b>	
	2.8 D Turbo [2D, 2H]	2,8	92/96	AGK; ATA		07.97-01.02	4	<b>0 432 193 731</b>	





50	2.4 D [28, 29, 21]	2,4	51	ACT	Fg.Nr. →21..P..022 900	08.92-04.93	6	0 432 217 240	0 986 430 187				
					Fg.Nr. 21..P..022 901→	04.93-04.96	6	0 432 217 272	0 986 430 187				
					55	DW	12.82-07.92	6	0 432 217 084	0 986 430 081			
	2.4 D Turbo [28, 29, 21]	2,4	70	ACL		09.92-04.96	6	0 432 217 232					
					75	DV	12.82-08.92	6	0 432 217 079	0 986 430 080			
55	2.4 D [28, 29, 21]	2,4	51	ACT	Fg.Nr. →21..P..022 900	08.92-04.93	6	0 432 217 240	0 986 430 187				
					Fg.Nr. 21..P..022 901→	04.93-04.96	6	0 432 217 272	0 986 430 187				
					55	DW	08.85-07.92	6	0 432 217 084	0 986 430 081			
	2.4 D Turbo [28, 29, 21]	2,4	70	ACL		09.92-04.96	6	0 432 217 232					
					75	DV	08.85-08.92	6	0 432 217 079	0 986 430 080			
<b>L80</b>													
	[2V]	4,3	103	AGF		01.95-12.99	4	9 430 082 759					
<b>Multivan T4</b>													
1.9	D [70, 7D]	1,9	45	1X		09.90-04.97	4	0 432 217 207	0 986 430 189				
	D Turbo [70, 7D]	1,9	50	ABL		10.92-06.03	4	0 432 217 242	0 986 430 188				
2.4	D, D Syncro [70, 7D]	2,4	55/57	AAB; AJA		09.90-06.03	5	0 432 217 207	0 986 430 189				
2.5	TDI [70, 7D]	2,5	65	AYY		10.01-06.03	5	0 432 193 619 <sup>1</sup>					
							5	0 432 193 662					
					75	AUF		05.99-06.03	AG	5	0 432 193 619 <sup>1</sup>		
									GS	5	0 432 193 621 <sup>1</sup>		
								Fg.Nr. →70..2..075 000	05.99-10.01	5	0 432 193 823		
								Fg.Nr. 70..2..075 000→	11.01-06.03	5	0 432 193 662		
							AYC		04.01-06.03	AG	5	0 432 193 619 <sup>1</sup>	
										GS	5	0 432 193 621 <sup>1</sup>	
								Fg.Nr. →70..2..075 000	04.01-10.01	5	0 432 193 823		
								Fg.Nr. 70..2..075 000→	11.01-06.03	5	0 432 193 662		
							111	AHY		05.98-09.00	5	0 432 193 608 <sup>1</sup>	
											5	0 432 193 669	
			AXG		09.00-06.03	5	0 432 193 550 <sup>1</sup>						
						5	0 432 193 552						
	TDI Syncro [70, 7D]	2,5	75	AXL		04.01-06.03	5	0 432 193 621 <sup>1</sup>					
							5	0 432 193 823					
	TDI, TDI Syncro [70, 7D]	2,5	75	ACV		01.95-06.03	AG	5	0 432 193 619 <sup>1</sup>				
							GS	5	0 432 193 621 <sup>1</sup>				
					Fg.Nr. →70..2..075 000	01.95-10.01	AG	5	0 432 193 662				
							GS	5	0 432 193 823				
					Fg.Nr. 70..2..075 000→	11.01-06.03	5	0 432 193 662					
<b>Transporter</b>													
1.6	D	1,6	40	BE <222>		10.81-10.89	4	0 432 217 084	0 986 430 081				
<b>Transporter T3</b>													
1.6	D [24, 25]	1,6	37	CS		01.81-07.87	4	0 432 217 083	0 986 430 081				
							4	0 432 217 084	0 986 430 081				
	D Turbo, D Turbo Syncro [24, 25]	1,6	51	JX		08.84-07.92	4	0 432 217 079	0 986 430 080				
1.7	D [24, 25]	1,7	42	KY		10.86-07.92	4	0 432 217 083	0 986 430 081				
							4	0 432 217 084	0 986 430 081				
<b>Transporter T4</b>													
1.9	D [70, 7D]	1,9	45	1X		09.90-04.97	4	0 432 217 207	0 986 430 189				
	D Turbo [70, 7D]	1,9	50	ABL		10.92-06.03	4	0 432 217 242	0 986 430 188				
2.4	D, D Syncro [70, 7D]	2,4	55/57	AAB; AJA		09.90-06.03	5	0 432 217 207	0 986 430 189				
2.5	TDI [70, 7D]	2,5	65	AYY		10.01-06.03	5	0 432 193 619 <sup>1</sup>					
							5	0 432 193 662					
					75	AUF		05.99-06.03	AG	5	0 432 193 619 <sup>1</sup>		
									GS	5	0 432 193 621 <sup>1</sup>		
								Fg.Nr. →70..2..075 000	05.99-10.01	5	0 432 193 823		
								Fg.Nr. 70..2..075 000→	11.01-06.03	5	0 432 193 662		
							AYC		04.01-06.03	AG	5	0 432 193 619 <sup>1</sup>	
										GS	5	0 432 193 621 <sup>1</sup>	
								Fg.Nr. →70..2..075 000	04.01-10.01	5	0 432 193 823		
								Fg.Nr. 70..2..075 000→	11.01-06.03	5	0 432 193 662		
							111	AHY		05.98-09.00	5	0 432 193 608 <sup>1</sup>	
											5	0 432 193 669	





◀ VW

<b>2.5</b> TDI [70, 7D]	2,5	111	AXG		09.00-06.03	5	<b>0 432 193 550</b> <sup>1</sup>
						5	<b>0 432 193 552</b>
TDI Syncro [70, 7D]	2,5	75	AXL		04.01-06.03	5	<b>0 432 193 621</b> <sup>1</sup>
						5	<b>0 432 193 823</b>
TDI, TDI Syncro [70, 7D]	2,5	75	ACV		01.95-06.03	AG	5 <b>0 432 193 619</b> <sup>1</sup>
						GS	5 <b>0 432 193 621</b> <sup>1</sup>
				Fg.Nr. →70..2..075 000	01.95-10.01	AG	5 <b>0 432 193 662</b>
						GS	5 <b>0 432 193 823</b>
				Fg.Nr. 70..2..075 000→	11.01-06.03		5 <b>0 432 193 662</b>
<b>6t</b>							
<b>6</b> .90	4,0	67	D 229-4		01.83-10.86	4	<b>9 430 082 289</b>
<b>7t</b>							
<b>7</b> .90 S	4,0	67	D 229-4		01.87-03.94	4	<b>9 430 082 289</b>
<b>11t</b>							
<b>11</b> .130	5,9	96	D 229-6		03.81-12.86	6	<b>9 430 082 276</b>
.140	5,9	102	D 229-6		09.87-10.90	6	<b>9 430 082 289</b>
<b>12t</b>							
<b>12</b> .140 H	5,9	99	D 229-6		03.94-02.00	6	<b>9 430 082 289</b>
<b>13t</b>							
<b>13</b> .130	5,9	96	D 229-6		03.81-12.86	6	<b>9 430 082 276</b>
<b>14t</b>							
<b>14</b> .140	5,8	101	D 229-6		01.87-12.89	6	<b>9 430 082 289</b>
.150	6,5	105	6.10		11.95-02.00	6	<b>9 430 082 767</b>
.170	8,3	121	6 CTAA		02.88-02.98	6	<b>0 432 191 812</b>
.170 BT	5,8	116	6 BTAA		04.97-02.00	6	<b>0 432 133 838</b>
.200	6,5	144	6.10		07.91-07.94	6	<b>9 430 082 745</b>
.210	8,3	157	6 CT		02.88-02.98	6	<b>0 432 191 799</b>
.220	8,3	157	6 CT		10.91-10.95	6	<b>9 430 082 753</b>
					11.95-02.00	6	<b>9 430 082 762</b>
<b>16t</b>							
<b>16</b> .170	8,3	125	6 CT		09.91-04.93	6	<b>0 432 191 804</b>
.180 CO	6,4	144	6.10 T		03.93-12.93	6	<b>9 430 082 745</b>
.210	8,3	160	6 CT		02.88-12.94	6	<b>9 430 082 753</b>
					01.95-02.00	6	<b>9 430 082 762</b>
.220	8,3	160	6 CT		01.91-10.95	6	<b>9 430 082 753</b>
					11.95-02.00	6	<b>9 430 082 762</b>
<b>22t</b>							
<b>22</b> .140	5,9	102	D 229-6		09.87-12.89	6	<b>9 430 082 289</b>
<b>24t</b>							
<b>24</b> .220	8,3	158	6 CT		01.91-10.95	6	<b>9 430 082 762</b>
					11.95-03.06	6	<b>9 430 082 753</b>
.250	8,3	184	6 CTAA		05.92-01.02	6	<b>9 430 082 753</b>
<b>35t</b>							
<b>35</b> .300	8,3	214	6 CTAA		04.91-02.00	6	<b>9 430 082 753</b>

**WHITE**

**WCL**

<b>42T</b> Conventional	12,0	232	TD 121 FC		04.85→	6	<b>0 432 191 863</b>	<b>0 986 430 032</b>
<b>46T</b> Conventional	12,0	232	TD 121 FC		04.85→	6	<b>0 432 191 863</b>	<b>0 986 430 032</b>





l/ccm



kW/(PS)



Typ



Zyl.



## ATLAS COPCO

## Serie PR-PRH

PR 425	8,5	99	F 6 L 413	02.72-12.86	6	0 432 291 807	0 986 430 124
700	14,0	165	F 10 L 413	05.72-12.86	10	0 432 291 807	0 986 430 124
PRH 425	12,7	121	F 8 L 714	05.71-12.86	8	0 432 227 003	

## Serie ST-ST5

ST 35	2,8	28	F 3 L 912	01.73-12.86	3	0 432 291 753	0 986 430 067
48	3,8	37	F 4 L 912	02.73-12.86	4	0 432 291 753	0 986 430 067
71	5,6	55	F 6 L 912	02.73-12.86	6	0 432 291 753	0 986 430 067
95	5,6	78	BF 6 L 912	10.77-12.86	6	0 432 291 752	
STS 35	2,8	28	F 3 L 912	02.73-12.86	3	0 432 291 753	0 986 430 067
48	3,8	37	F 4 L 912	02.73-12.86	4	0 432 291 753	0 986 430 067
71	5,6	55	F 6 L 912	02.73-12.86	6	0 432 291 753	0 986 430 067
95	5,6	78	BF 6 L 912	10.77-12.86	6	0 432 291 752	

## US

85	1,9	18	F 2 L 912	02.72-12.86	2	0 432 291 753	0 986 430 067
----	-----	----	-----------	-------------	---	---------------	---------------

## BENFRA

## Serie 7-12

9.32	5,9	96	8361 SI 10.00	01.90-01.05	6	0 432 281 704	
------	-----	----	---------------	-------------	---	---------------	--

## BOMAG

## BW

6	2,8	38	F 3 L 912	01.73-01.88	3	0 432 291 753	0 986 430 067
10 A	3,8	41	F 4 L 912	01.73-01.88	4	0 432 291 753	0 986 430 067
15 A	5,7	78	F 6 L 912	01.73-01.88	6	0 432 291 753	0 986 430 067
75 HS	0,6	7,5	Hatz-E 785	04.80-04.95	1	0 432 297 027	
90 S, SH, SL	0,7	8,83	Hatz-E 89 FG	05.77-01.88	1	0 432 296 010	
200	3,8	44	F 4 L 912	01.73-06.86	4	0 432 291 753	0 986 430 067

## CASE IH (CASE INTERNATIONAL)

## Serie E

833 , A	3,9	49	D-239	01.86-12.90	4	0 432 291 733	
---------	-----	----	-------	-------------	---	---------------	--

## Serie V

433	2,5	29	D-155	01.86-06.90	3	0 432 291 719	
533	2,5	33	D-155	01.86-06.90	3	0 432 291 719	

## Serie 300

321	3,9	55	D-239	01.86-06.86	4	0 432 291 733	
-----	-----	----	-------	-------------	---	---------------	--

## Serie 400

431	3,9	55	D-239	01.86-06.86	4	0 432 291 733	
	5,1	63	D-310	01.86-06.86	6	0 432 291 719	
433	2,5	26	D-155	01.86-06.90	3	0 432 291 719	

## Serie 500

531	2,5	33	D-310	01.86-06.86	3	0 432 291 719	
	5,9	92	D-358	01.86-06.86	6	0 432 291 774	
533 , A	2,5	33	D-155	01.86-12.90	3	0 432 291 719	

## Serie 600

644 , A	3,4	44	D-206	01.86-06.86	4	0 432 291 719	
---------	-----	----	-------	-------------	---	---------------	--

## Serie 800

833 , A	3,9	49	D-239	09.81-12.90	4	0 432 291 733	
844 , A	4,3	55	D-246	01.86-12.90	4	0 432 291 733	
S, SA	4,4	59	D-268	01.86-12.90	4	0 432 291 733	

## Serie 7000

7130	8,3	149	6CT	01.88-01.03	6	0 432 191 812	
7140	8,3	169	6CTA	01.88-01.03	6	0 432 191 796	





**DEMAG**

H-Serie								
31	8,5	115	F 6 L 413 V		04.74-12.87	6	0 432 291 807	0 986 430 124
36	8,5	115	F 6 L 413 V		06.76-12.87	6	0 432 291 807	0 986 430 124
41	11,3	155	F 8 L 413		04.74-12.87	8	0 432 291 807	0 986 430 124
51	11,3	155	F 8 L 413		04.74-12.87	8	0 432 291 807	0 986 430 124

**DEUTZ-FAHR**

D								
2807	1,9	21	F 2 L 912		06.86-06.01	2	0 432 291 753	0 986 430 067
3607	1,9	25	F 2 L 912		06.86-06.01	2	0 432 291 753	0 986 430 067
6807	3,8	49	F 4 L 912		06.86-06.01	4	0 432 291 753	0 986 430 067
7007	3,8	51	F 4 L 912		06.86-06.01	4	0 432 291 753	0 986 430 067
DX								
3	.10 A, .10 F/V, .30 A, .30 F/V	2,8	34/40	F 3 L 912	06.86-06.01	3	0 432 291 753	0 986 430 067
	.50 A, .50 F/V	3,1	40/44	F 3 L 913	06.86-06.01	3	0 432 291 753	0 986 430 067
	.60, .70 A, .70 F/V	3,8	48-51	F 4 L 912	06.86-06.01	4	0 432 291 753	0 986 430 067
	.80, .90 A, .90 F/V	4,1	55	F 4 L 913	06.86-06.01	4	0 432 291 753	0 986 430 067
4	.10	3,8	51	F 4 L 912	06.86-06.01	4	0 432 291 753	0 986 430 067
	.30 A, .50 A, .51, .70 A	4,1	55-66	BF4L 913; BF4L 913 T; F 4 L 913	06.86-01.05	4	0 432 291 753	0 986 430 067
6	.05/.10 A	5,7	72-74	F 6 L 912	06.86-06.01	6	0 432 291 753	0 986 430 067
	.30 A	6,1	85	F 6 L 913	06.86-06.01	6	0 432 291 753	0 986 430 067
	.50 A	6,1	101	BF6L 913	06.86-06.01	6	0 432 291 669	
	.60	6,0	110	BF6L 913	10.88-10.03	6	0 432 291 669	
7	.10 A	6,1	117	BF6L 913	06.86-06.01	6	0 432 291 669	
Intrac								
6	.30 turbo, .60 turbo	6,0	93/110	BF6L 913; BF6L 913 T	01.88-01.04	6	0 432 291 669	
2004		3,8	51	F 4 L 912	05.78-12.88	4	0 432 291 753	0 986 430 067
M								
3610		6,0	141	BF6L 913 C	03.87-03.02	6	0 432 291 752	
3630		6,0	141	BF6L 913 C	03.87-03.02	6	0 432 291 752	

**EICHER**

Serie 635-680								
635 K, KA	1,9	25,7	EDL 2-2		01.86-01.01	2	0 432 291 695	
642 K, KA	1,9	31	EDL 2-4		01.86-01.01	2	0 432 291 695	
645 K, KA	2,9	31	EDL 3-6		01.86-01.01	3	0 432 291 695	
648 V, VA	2,9	35	EDL 3-7.2		01.87-01.02	3	0 432 291 695	
656 P, PA, V, VA	2,9	41	EDL 3-8.1		01.86-11.87	3	0 432 291 695	
666 P, PA, V, VA	2,9	49	EDL 3-9.1		01.86-01.02	3	0 432 291 695	
680 P, PA	3,9	59	EDL 4-5.1		01.87-01.02	4	0 432 291 695	
Serie 3000								
3026	5,9	79	EDL 6-1		03.82-03.97	6	0 432 291 695	
3028	5,9	82	EDL 6-5		09.83-09.98	6	0 432 291 695	
3030	5,9	107	EDL 6-6		09.83-09.98	6	0 432 291 695	
Serie 3200								
3257, S	3,0	35	EDL 3-7		03.82-12.87	3	0 432 291 695	
3258 A, AS	3,0	35	EDL 3-7		03.82-12.87	3	0 432 291 695	
Serie 3300								
3357	3,0	41	EDL 3-8		03.82-12.87	3	0 432 291 695	
3358	3,0	41	EDL 3-8		03.82-12.87	3	0 432 291 695	







Serie 3400						
3457	3,0	49	EDL 3-9		03.82-12.87	3 0 432 291 695
3458	3,0	49	EDL 3-9		03.82-12.87	3 0 432 291 695
Serie 3500						
3559	3,9	53	EDL 4-4		01.84-01.99	4 0 432 291 695
3560	3,9	53	EDL 4-4		01.84-01.99	4 0 432 291 695

## FENDT

Farmer 300-Serie						
306 LS/FW 168	4,2	50	D 226-4		02.80-02.95	4 0 432 291 731
308 LS/FW 178	4,2	57	D 226-4		02.80-02.95	4 0 432 291 731

## FIAT

50-Serie						
55 .90	2,7	38	8035.06.200		10.84-08.88	3 0 432 291 654
60-Serie						
60 .46, .90, DT	2,9	42	8035.05.200; 8035.05.206, 306		10.84-08.88	3 0 432 291 655
65 .66, .90	3,6	48	8045.06.220, 321; 8045.06.225		06.87-08.88	4 0 432 291 654
70-Serie						
70 .90	3,6	51	8045.06.200		10.84-08.88	4 0 432 291 654
80-Serie						
80 .90, DT	3,9	59	8045.05.205		10.84-08.88	4 0 432 291 655
90-Serie						
90 .90	4,9	70	8055.05.200		10.84-08.88	5 0 432 291 655
100-Serie						
100 .90	5,4	74	8065.06.200		10.84-08.88	6 0 432 291 654
110 .90	5,9	81	8065.05.220		11.86-08.88	6 0 432 291 655
115.90	5,9	85	8065.05.000		10.84-08.88	6 0 432 291 655
130 .90	5,9	94	8065.25.010		10.84-08.88	6 0 432 291 655
140 .90	5,9	107	8065.25.000		10.84-08.88	6 0 432 291 655
160 .90	8,1	118	OM-8365.25.503; OM-8365.25.513, 515		01.84-08.88	6 0 432 281 704
180 .90	8,1	129	OM-8365.25.502; OM-8365.25.512, 514		01.84-08.88	6 0 432 281 704

## FIAT-ALLIS

F						
4 M	2,9	42	8035.05.265		04.85-12.92	3 0 432 291 655
FA						
120	5,5	92	8065.25.096		09.84-05.92	6 0 432 291 655
150	8,1	122	8365.25.542		03.84-03.99	6 0 432 281 704
200	5,9	87	8215.1A 11006		01.84-12.89 CSA	6 0 432 281 732
FD						
7	5,9	73	8065.05.295		03.86-10.92	6 0 432 291 655
14 E	8,1	130	8365.25.541		12.88-12.92	6 0 432 281 704
FE						
16	5,5	63	8061 1000 ALL 018		08.85-12.87	6 0 432 291 655
20	8,1	99	8365.05.530		10.81-12.88	6 0 432 281 710
24	8,1	104	8365.05.531		10.83-12.88	6 0 432 281 710
28	8,1	121	8365.25.530		05.82-12.88	6 0 432 281 704
FG						
65 A	3,7	50	8041.04.300		03.84-12.86	4 0 432 281 718
					01.87-01.88	4 0 432 291 655
FR						
12 B	5,9	106	8065.25.092		01.86-03.90	6 0 432 291 655
130	5,9	107	8065.25.094		04.90-04.05	6 0 432 291 655



**FORD NEW HOLLAND**

TF						
42	7,8	151	Ford-678 HTA	12.86-12.01	6	9 430 082 711
TR						
86	7,8	135	Ford-678 HT	04.87-12.88	6	9 430 082 708
		177	Ford-678 HTA	01.89-01.04	6	9 430 082 711
TX						
30	6,6	103	Ford-666 HT	01.86-01.01	6	9 430 082 714
32	6,6	114	Ford-666 HT	01.86-01.01	6	9 430 082 714
34	7,8	135	Ford-678 HT	04.87-04.02	6	9 430 082 708
		151	Ford-678 HTA	12.86-06.01	6	9 430 082 711
36	7,8	176	Ford-678 HTA	12.86-12.01	6	9 430 082 711

**HAMM**

GRW						
10	5,7	64	F 6 L 912	05.77-05.92	6	0 432 291 753 0 986 430 067
15	5,7	64	F 6 L 912	05.77-06.86	6	0 432 291 753 0 986 430 067

**HANOMAG GMBH**

C						
44 C	7,2	85	D 943 B	02.80-07.92	4	0 432 192 884
55 C	9,5	108	D 962 B	02.80-03.96	6	0 432 192 883
66 C	10,8	157	D 963 A 1 Turbo	02.80-03.96	6	0 432 192 884
D						
600 D	9,5	108	D 962 K	02.80-03.96	6	0 432 192 883
700 D	10,8	150	D 963 A 1 Turbo	04.80-03.96	6	0 432 192 884
L						
600 D	9,5	108	D 962 K	02.80-03.96	6	0 432 192 883
Serie 5-70						
44 C	7,2	85/92	D 943 A 1 Turbo; D 943 B	02.80-03.96	4	0 432 192 884
55 C	9,5	108	D 962 B	02.80-03.96	6	0 432 192 883
	10,8	118	D 963 B	01.81-03.96	6	0 432 192 884
66 C	10,8	157	D 963 A 1 Turbo	02.80-03.96	6	0 432 192 884
77 C	10,8	193	D 963 A 2 Turbo	02.80-03.96	6	0 432 192 884

**HOLDER**

A						
40	1,6	24	HD 6001-2	07.79-12.88	2	0 432 291 758
50	2,4	37	HD 6001-3	07.79-12.88	3	0 432 291 758

**IVECO**

DI						
20 C	2,9	40	8035.05.359	02.86-12.90	3	0 432 291 655
25 C	2,9	40	8035.05.359	02.86-12.90	3	0 432 291 655
30 C	2,9	40	8035.05.359	02.86-12.90	3	0 432 291 655
25						
H 2,4	2,9	40	8035.05.377	11.85-04.89	3	0 432 291 655
M 2,4	2,9	40	8035.05.377	11.85-04.89	3	0 432 291 655
30						
H 2,4	2,9	40	8035.05.377	11.85-04.89	3	0 432 291 655
M 2,4	2,9	40	8035.05.377	11.85-04.89	3	0 432 291 655



l/ccm



kW/(PS)



Typ



Zyl.



## JOHN DEERE

## Serie MD 1000

1085 , Hydro/4	7,6	125/143	6.466 AZ-01; 6.466 TZ-01	02.82-03.97	6	0 432 231 860
----------------	-----	---------	--------------------------	-------------	---	---------------

## Serie 4000

4050	7,6	94	6466 TRW-06	06.87-12.89	6	0 432 231 851
------	-----	----	-------------	-------------	---	---------------

4240 Sync.-Shift	7,6	94	6466 DL-01	10.77-12.87	6	0 432 231 851
------------------	-----	----	------------	-------------	---	---------------

4250	7,6	106	6466 TRW-20	06.87-12.88	6	0 432 231 851
------	-----	-----	-------------	-------------	---	---------------

4650	7,6	141	6466 A	03.85-10.88	6	0 432 131 867
------	-----	-----	--------	-------------	---	---------------

4850	7,6	158	6466 A <EDC>	05.88-10.88	6	0 432 131 867
------	-----	-----	--------------	-------------	---	---------------

	175	6076 HRW-01	03.89-03.04	6	0 432 131 865
--	-----	-------------	-------------	---	---------------

## Serie 5000

5830	10,0	212	6619 AE-03	10.89-10.04	6	9 430 233 003
------	------	-----	------------	-------------	---	---------------

## KÄSSBOHRER

## FM-Serie

23.150 K	6,1	112	BF 6 L 913	01.88-01.03	6	0 432 291 752
----------	-----	-----	------------	-------------	---	---------------

## LAMBORGHINI (S+L+H)

## C-Serie

362	1,8	27	982 L	06.83-04.86	2	0 432 281 705
-----	-----	----	-------	-------------	---	---------------

554 Compact, Ergomatic	2,8	39	100.3 P	06.87-12.00	3	0 432 281 705
------------------------	-----	----	---------	-------------	---	---------------

583	2,7	40	983 P	04.83-06.87	3	0 432 281 705
-----	-----	----	-------	-------------	---	---------------

664 Compact HD, Ergomatic	3,1	46	103.5 P; 105.3 P	06.87-12.00	3	0 432 281 705
---------------------------	-----	----	------------------	-------------	---	---------------

674 Ergomatic	3,7	48	916.4 W	01.84-05.86	4	0 432 291 685
---------------	-----	----	---------	-------------	---	---------------

774	3,7	55	916.4 W	01.84-05.86	4	0 432 291 685
-----	-----	----	---------	-------------	---	---------------

.80	4,0	59	1000.4 W	06.86-12.00	4	0 432 291 685
-----	-----	----	----------	-------------	---	---------------

## R

235 S	1,8	25	982 L	06.83-09.90	2	0 432 281 705
-------	-----	----	-------	-------------	---	---------------

483	2,7	35	983 L	06.83-01.86	3	0 432 281 705
-----	-----	----	-------	-------------	---	---------------

513 V, DT	2,7	35	983 L	03.83-12.95	3	0 432 281 705
-----------	-----	----	-------	-------------	---	---------------

583	2,8	38	100.3 P	01.84-02.86	3	0 432 281 705
-----	-----	----	---------	-------------	---	---------------

613 , DT	3,1	43	105.3 P	01.82-02.88	3	0 432 281 705
----------	-----	----	---------	-------------	---	---------------

683 DT-RM	3,1	44	105.3 P	06.82-12.86	3	0 432 281 705
-----------	-----	----	---------	-------------	---	---------------

714 DT, 2 RM	3,8	50	100.4 P	03.84-02.88	4	0 432 281 705
--------------	-----	----	---------	-------------	---	---------------

724 , F	4,2	61	105.4 P	02.82-05.87	4	0 432 281 705
---------	-----	----	---------	-------------	---	---------------

## 100-Serie

105 Formula	0,0	75	1000.4 WTI	03.89-12.99	4	0 432 291 685
-------------	-----	----	------------	-------------	---	---------------

## 300-Serie

345 , F	2,7	33	983 L	03.88-12.95	3	0 432 281 705
---------	-----	----	-------	-------------	---	---------------

## 400-Serie

483 L, N	2,7	35	983 L	04.83-04.86	3	0 432 281 705
----------	-----	----	-------	-------------	---	---------------

## 500-Serie

550 DT, R	2,7	22	983 L	01.86-12.95	3	0 432 281 705
-----------	-----	----	-------	-------------	---	---------------

573 -60 N	3,0	44	1000.3 W	02.88-11.90	3	0 432 291 685
-----------	-----	----	----------	-------------	---	---------------

574 -60 N	3,0	44	1000.3 W	02.88-11.90	3	0 432 291 685
-----------	-----	----	----------	-------------	---	---------------

583 DT Basso	2,8	38	100.3 P	05.85-02.86	3	0 432 281 705
--------------	-----	----	---------	-------------	---	---------------

## 600-Serie

660	3,1	44	105.3 P	01.87-12.99	3	0 432 281 705
-----	-----	----	---------	-------------	---	---------------

F	3,0	44	1000.3 A	06.87-12.99	3	0 432 291 685
---	-----	----	----------	-------------	---	---------------

674 DT, -5, -5 Bosso	3,7	48	916.4 W	10.84-05.86	4	0 432 291 685
----------------------	-----	----	---------	-------------	---	---------------

-70, -70 N, -70 N Bosso	4,0	54	1000.4 W	06.86-12.99	4	0 432 291 685
-------------------------	-----	----	----------	-------------	---	---------------

683 L, N	3,1	45	105.3 P	04.83-06.87	3	0 432 281 705
----------	-----	----	---------	-------------	---	---------------

## 700-Serie

774 -5	3,7	55	916.4 W	06.85-05.86	4	0 432 291 685
--------	-----	----	---------	-------------	---	---------------

-80, -80 DT, -80 N	4,0	54	1000.4 W	06.86-12.99	4	0 432 291 685
--------------------	-----	----	----------	-------------	---	---------------

775	4,0	54	1000.4 W	06.87-12.99	4	0 432 291 685
-----	-----	----	----------	-------------	---	---------------





◀ LAMBORGHINI

800-Serie						
874 .90	4,0	65	1000.4 WT	06.86-12.99	4	0 432 291 685
900-Serie						
956 DT, 2 RM	5,5	70	916.6 W 1	01.84-12.99	6	0 432 291 737
1000-Serie						
1106 DT, 2 RM	5,5	81	916.6 W 2; 916.6 W2	01.84-12.99	6	0 432 291 685
1306 Turbo DT	5,5	92	916.6 WT	01.84-12.99	6	0 432 291 685
1506 Turbo	6,8	107	1106 HT	01.84-12.99	6	0 432 291 737
1706 Turbo	6,8	121	1106 AT	01.84-12.99	6	0 432 291 737

LIEBHERR

PR						
721	5,7	63	OM 352	03.74-06.90	6	0 432 231 887 0 986 430 056
R						
911	3,8	44	F 4 L 912	04.72-06.90	4	0 432 291 753 0 986 430 067
921 , B	3,8	51	F 4 L 912	04.72-06.90	4	0 432 291 753 0 986 430 067
961	8,5	115	F 6 L 413 V	02.73-06.90	6	0 432 291 807 0 986 430 124
971	11,3	154	F 8 L 413 V	02.73-06.90	8	0 432 291 807 0 986 430 124
981	6,1	118	BF 6 L 913	07.78-06.90	6	0 432 291 752

LINDE

H						
20	3,1	35	F 3 L 913 G	11.84-12.86	3	0 432 291 652
				01.87-11.99	3	0 432 191 712
25	3,1	35	F 3 L 913 G	11.84-12.86	3	0 432 291 652
				01.87-11.99	3	0 432 191 712
30	3,1	35	F 3 L 913 G	11.84-12.86	3	0 432 291 652
				01.87-11.99	3	0 432 191 712
35	3,8	49	F 4 L 912	06.81-06.97	4	0 432 291 753 0 986 430 067
40	3,8	49	F 4 L 912	06.81-06.97	4	0 432 291 753 0 986 430 067
70	5,7	74	F 6 L 912	06.81→	6	0 432 291 753 0 986 430 067

MERCEDES-BENZ

Trac							
700 , G	3,8	48	OM 314.956	01.76-03.87	4	0 432 231 887 0 986 430 056	
				, G, K	03.87-07.88	4	0 432 231 824 0 986 430 046
					08.88-12.92	4	0 432 231 736 0 986 430 178
800	3,8	55	OM 314.957	03.81-03.87	4	0 432 231 824 0 986 430 046	
				, G, K	03.87-07.88	4	0 432 231 824 0 986 430 046
					08.88-12.92	4	0 432 231 736 0 986 430 178
900	3,8	63	OM 314.970 Turbo	09.81-03.87	4	0 432 231 824 0 986 430 046	
				Turbo	4,0	66	OM 364.951 A
1000	5,7	70	OM 353.985	11.82-03.87	6	0 432 231 887 0 986 430 056	
				, G, K	03.87-07.88	6	0 432 231 824 0 986 430 046
					08.88-12.92	6	0 432 231 736 0 986 430 178
1100	5,7	81	OM 353.949	10.76-03.87	6	0 432 231 887 0 986 430 056	
				, G, K	03.87-07.88	6	0 432 231 824 0 986 430 046
					08.88-12.92	6	0 432 231 736 0 986 430 178
1300	5,7	92	OM 353.957 Turbo	11.82-03.87	6	0 432 231 824 0 986 430 046	
				Turbo	6,0	92	OM 366.977 A
1400 Turbo	6,0	100	OM 366.958 A	03.87-12.92	6	0 432 231 824 0 986 430 046	
1500	5,7	110	OM 353.976 Turbo	07.80-03.87	6	0 432 231 823 0 986 430 045	
1600 Turbo	6,0	115	OM 366.954 A	03.87-12.92	6	0 432 231 824 0 986 430 046	





l/ccm



kW/(PS)



Typ



Zyl.

**O & K (ORENSTEIN & KOPPEL)****MH-Serie**

4	3,8	46	F 4 L 912	09.76-06.90	4	0 432 291 753	0 986 430 067
6	4,7	58	F 5 L 912	09.76-06.90	5	0 432 291 753	0 986 430 067
	5,7	70	F 6 L 912	09.76-06.90	6	0 432 291 753	0 986 430 067

**RH-Serie**

4	3,8	46	F 4 L 912	09.76-06.90	4	0 432 291 753	0 986 430 067
6	4,7	58	F 5 L 912	09.76-06.90	5	0 432 291 753	0 986 430 067
	5,7	70	F 6 L 912	09.76-06.90	6	0 432 291 753	0 986 430 067
9	5,7	74	F 6 L 912	01.72-06.90	6	0 432 291 753	0 986 430 067
18 HD, LC	11,3	154	F 8 L 413	04.76-06.90	8	0 432 291 807	0 986 430 124

**POCLAIN****Serie RC**

491	8,5	115	F 6 L 413	01.73-01.88	6	0 432 291 807	0 986 430 124
556	8,5	115	F 6 L 413	01.73-01.88	6	0 432 291 807	0 986 430 124

**Serie 60**

60 CL, P	3,8	46	F 4 L 912	03.76-03.91	4	0 432 291 753	0 986 430 067
----------	-----	----	-----------	-------------	---	---------------	---------------

**Serie 70**

75 CL, P	4,7	62	F 5 L 912	06.75-09.90	5	0 432 291 753	0 986 430 067
----------	-----	----	-----------	-------------	---	---------------	---------------

**Serie 90**

90 CK, CL, P	5,7	70/78	F 6 L 912	03.75-01.01	6	0 432 291 753	0 986 430 067
--------------	-----	-------	-----------	-------------	---	---------------	---------------

**SAME (S+L+H)****Antares**

110	6,0	81	1000.6 A	12.89-12.04	6	0 432 291 685	
130	6,0	96	1000.6 AT	12.89-12.04	6	0 432 291 685	

**Centaurio**

70 Export, Spezial	3,8	50	100.4 P	05.83-10.87	4	0 432 281 705	
--------------------	-----	----	---------	-------------	---	---------------	--

**Centurion**

75 Export	4,2	55	105.4 P	05.83-10.87	4	0 432 281 705	
-----------	-----	----	---------	-------------	---	---------------	--

**Condor**

C	2,7	37	983 L	05.83-05.86	3	0 432 281 705	
55	2,8	38	100.3 P	05.83-10.87	3	0 432 281 705	

**Delfino**

35	1,8	25	982 L	05.83-01.86	2	0 432 281 705	
----	-----	----	-------	-------------	---	---------------	--

**Drago**

120	6,2	85	1056 P	05.83-05.86	6	0 432 281 705	
-----	-----	----	--------	-------------	---	---------------	--

**Explorer**

55	2,8	40	916.3 A	04.83-05.86	3	0 432 291 685	
60 Export, Special	3,0	44	100.3 A	06.86-06.01	3	0 432 291 685	
65 , C	3,7	48	916.4 A	03.83-09.86	4	0 432 291 685	
70 C, Export, Special	4,0	51	1000.4 A	07.86-10.01	4	0 432 291 685	
75 , C	3,7	55	916.4 A	01.84-09.86	4	0 432 291 685	
80 C, Export, Special	4,0	59	1000.4 A	07.86-10.01	4	0 432 291 685	
85	3,7	63	916.4 TA	02.85-05.86	4	0 432 291 685	
90 Export, Special Turbo	4,0	65	1000.4 AT	06.86-06.01	4	0 432 291 685	

**Falcon**

	2,7	37	983 L	09.85-10.87	3	0 432 281 705	
--	-----	----	-------	-------------	---	---------------	--

**Fox**

35	1,8	26	982 L	05.83-04.86	2	0 432 281 705	
45	2,7	33	983 L	05.83-04.86	3	0 432 281 705	
55	2,7	39	983 L	05.83-04.86	3	0 432 281 705	

**Frutteto**

60	3,0	44	1000.3 A	04.87-04.02	3	0 432 291 685	
75	4,0	55	1000.4 A	04.87-04.02	4	0 432 291 685	





◀ SAME

Galaxy							
170	6,2	121	105.6 PTI	06.83-06.98	6	0 432 291 721	
Laser							
90	4,2	65	105.4 PT	03.84-03.89	4	0 432 281 705	
100	5,2	72	105.5 P	03.84-03.99	5	0 432 281 705	
110	5,7	81	100.6 P	05.83-03.98	6	0 432 281 705	
130	6,2	92	105.6 P	04.83-04.98	6	0 432 281 705	
150	6,2	107	105.6 PS	03.83-03.98	6	0 432 291 721	
Mercury							
85 Export	4,2	61	105.4 P	05.83-10.87	4	0 432 281 705	
Ranger							
45	2,7	33	983 L	05.83-02.97	3	0 432 281 705	
Solar							
50	2,7	37	983 L	06.86-06.01	3	0 432 281 705	
55 C	2,8	40	100.3 P	06.87-06.02	3	0 432 281 705	
Titan							
160	6,0	117	1000.6 ATI	05.91→	6	0 432 291 584	
190	6,0	139	1000.6 WTIR	01.92→	6	0 432 291 584	
Vigneron							
35	1,8	25	982 L	05.83-04.90	2	0 432 281 705	
50	2,7	35	983 L	05.83-02.97	3	0 432 281 705	
60	3,1	43	105.3 P	05.83-02.88	3	0 432 281 705	

**SCHAEF**

HM							
25	1,9	24	F 2 L 912	03.74-12.86	2	0 432 291 753	0 986 430 067
HML							
30	2,8	38	F 3 L 912	03.73-12.86	3	0 432 291 753	0 986 430 067
HR							
26	1,9	24	F 2 L 912	03.74-12.86	2	0 432 291 753	0 986 430 067
SKL							
300	1,9	24	F 2 L 912	03.74-12.86	2	0 432 291 753	0 986 430 067
500	2,8	35	F 3 L 912	03.73-12.86	3	0 432 291 753	0 986 430 067
700	2,8	38	F 3 L 912	03.73-12.86	3	0 432 291 753	0 986 430 067

**STEYR (STEYR-DAIMLER-PUCH AG)**

Serie 8000							
8055	2,6	35	WD 311.46	09.86-09.01	3	0 432 292 873	
,, a	2,6	35	WD 311.44; WD 311.45	02.82-09.86	3	0 432 292 874	
a	2,6	35	WD 311.47	09.86-02.87	3	0 432 292 874	
				03.87-09.01	3	0 432 292 873	
8060 ,, a	2,6	35	WD 311.40; WD 311.41	01.80-02.87	3	0 432 292 874	
8065 , a	2,6	41	WD 311.85	09.86-09.01	3	0 432 291 623	
8070 , a	3,5	47	WD 411.43, 44	10.84-10.99	4	0 432 291 622	
8075 , a	3,5	47	WD 411.45, 46	01.84-01.99	4	0 432 291 622	
8080 , a	3,5	53	WD 411.89, 90	06.84-06.99	4	0 432 291 623	
8090 , a	3,5	59	WD 411.87, 88	01.84-01.99	4	0 432 291 623	
8130 , a	5,2	81	WD 611.87, 88	07.84-07.99	6	0 432 291 623	
8150 , a	6,6	99	WD 612.87	12.82-12.97 CSA	6	0 432 281 812	
8170 , a	6,6	100	WD 612.89	05.81-12.88 CSA	6	0 432 281 812	

**VALMET**

Serie 500							
505 , -4	3,3	48	TD 33 DS 5(311 DS 5)	08.82-08.97	3	0 432 292 878	
Serie 600							
605 , -4	3,3	53	TD 33 DS 6(311 DS 6)	08.82-08.97	3	0 432 292 878	





<b>Serie 700</b>						
705 , -4	4,4	61	TD 44 DS 7(411 DS 7)	08.82-08.97	4	<b>0 432 292 878</b>
<b>Serie 800</b>						
805 , -4	4,4	70	TD 44 DS 8(411 DS 8)	08.82-08.97	4	<b>0 432 292 878</b>

**VOLVO BM**

<b>A</b>						
20	6,7	137	TD 71 G	08.86-08.01	6	<b>0 432 191 824</b>
28	9,6		TD 102	04.87-04.03	6	<b>0 432 191 788 0 986 430 167</b>
30	9,6	200	TD 102 KF	01.91→	6	<b>0 432 191 788 0 986 430 167</b>
<b>L</b>						
50	4,5		TD 45 B	11.91→	4	<b>0 432 191 841</b>
		69	TD 45 E	11.91-12.91	4	<b>0 432 191 723</b>
70	4,5	85	TD 45 B	11.91→	4	<b>0 432 191 800</b>
90	5,5	115	TD 61 GB	11.91→	6	<b>0 432 191 801 0 986 430 494</b>
120	6,7	148	TD 71 G-285	01.87-01.02	6	<b>0 432 191 802</b>
<b>LM</b>						
622	0,0		D 45 B	03.85-03.00	0	<b>0 432 191 841</b>
642	0,0		D 45 B	03.85-03.00	0	<b>0 432 191 841</b>
4200 B	0,0		D 45 B	03.85-03.00	4	<b>0 432 191 841</b>
EM	0,0		TD 45 EM	09.85-07.86	4	<b>0 432 191 813</b>
4300	0,0		TD 45	03.85-03.00	4	<b>0 432 191 842</b>
			TD 45 B	03.85-03.00	4	<b>0 432 191 842</b>
			TD 45 B EM; TJD 45 B	03.85-03.00	4	<b>0 432 191 813</b>
B	0,0		TD 45 B	09.85-06.86	4	<b>0 432 191 800</b>
4500 B	0,0	147	TD 71 G	01.86-01.01	6	<b>0 432 191 802</b>
<b>Serie 800</b>						
861	5,5	122	TD 60 B	09.79-07.86	6	<b>0 432 191 870</b>
<b>Serie 4000</b>						
4400	5,5	94	TD 60 B	01.79-06.86	6	<b>0 432 191 864</b>
4500	7,0	121	TD 70 H	12.79-06.86	6	<b>0 432 191 850</b>
<b>Serie 6000</b>						
6300	4,5	84	TD 45 E	10.92→	4	<b>0 432 191 722</b>





**CDC (CONSOLIDATED DIESEL CO.)**

<b>BT</b> 4 BT-3.9	3,9		4 BT-3.9	08.90→	4	<b>0 432 131 840</b>
		64	4 BT-3.9	07.90→	4	<b>0 432 131 838</b>
6 BT-5.9	5,9		6 BT-5.9	08.90→	6	<b>0 432 131 840</b>
		86	6 BT-5.9	07.90→	6	<b>0 432 131 838</b>
<b>BTA</b> 4 BTA-3.9	3,9	81	4 BTA-3.9	F 09.91→	4	<b>0 432 131 835</b>
6 BTA-5.9	5,9	143	6 BTA-5.9	F 08.90→	6	<b>0 432 131 837</b>
				F 10.89→	6	<b>0 432 131 876</b>
<b>CT</b> 6 CT-830	8,3	156-157	6 CT-830	03.87→	6	<b>0 432 191 812</b>

**DAF**

<b>NS</b> 133 L	6,2	133	NS 133 L <EURO I>	02.92-02.92	0	<b>0 432 191 701</b>
				03.92→	0	<b>0 432 191 702</b>
133 M	6,2	133	NS 133 M <EURO II>	09.92→	6	<b>0 432 191 647</b>
156	6,2	156	NS 156	03.91→	6	<b>0 432 191 820</b>
156 G	6,2	156	NS 156 G	08.90→	6	<b>0 432 191 776</b>
156 L	6,2	156	NS 156 L <EURO I>	03.92→	6	<b>0 432 191 702</b>
<b>WS</b> 222 G, 268	11,6	222/268	WS 222 G; WS 268	05.91-04.01	6	<b>0 432 291 588</b>
222 L, 295 L, 315 L	11,6	222/295/ 315	WS 222 L <EURO I>; WS 295 L <EURO I>; WS 315 L <EURO I>	12.91-04.01	6	<b>0 432 291 543</b>
222 LX	11,6	222	WS 222 LX	03.92-04.01	6	<b>0 432 291 543</b>
225	11,6	225	WS 225	03.90-04.01 CSA	6	<b>0 432 291 602</b>
242	11,6	242	WS 242	11.91-04.01	6	<b>0 432 291 587</b>
242 L	11,6	242	WS 242 L <EURO I>	03.92-04.01	6	<b>0 432 291 542</b>
259, 282 L	11,6	259/282	WS 259; WS 282 L <EURO I>	03.90-04.01	6	<b>0 432 291 603</b>
268 G	11,6	268	WS 268 G	03.90-04.01	6	<b>0 432 291 587</b>
268 L	11,6	268	WS 268 L <EURO I>	12.91-04.01	6	<b>0 432 291 542</b>
270	11,6	270	WS 270	03.90-04.01	6	<b>0 432 291 627</b>
295	11,6	295	WS 295	08.91-04.01	6	<b>0 432 291 588</b>
295 G	11,6	295	WS 295 G	08.91-04.01	6	<b>0 432 291 561</b>
315 G	11,6	315	WS 315 G	03.91-04.01	6	<b>0 432 291 561</b>
315 M	11,6	315	WS 315 M <EURO II>	03.93-04.01	6	<b>0 432 291 525</b>

**HATZ**

<b>Z</b> 788	1,2	17	Z 788	05.73→	2	<b>0 432 291 838</b>
789, 790	1,3	20/22	Z 789; Z 790	03.71→	2	<b>0 432 291 838</b>
<b>1D</b> 60	0,5	7,8	1 D 60	04.89→	1	<b>0 432 291 572</b>
80	0,7	10,5	1 D 80	04.89→	1	<b>0 432 291 590</b>
<b>2G</b> 30	0,9	15	2 G 30	01.87-02.89	2	<b>0 432 291 626</b>
				03.89→	2	<b>0 432 291 593</b>
40	0,9	15	2 G 40	03.89→	2	<b>0 432 291 593</b>
<b>2M</b> 40	1,7	14,2	2 M 40	04.85-01.96	2	<b>0 432 291 692</b>
				02.96→	2	<b>0 432 193 722</b>
<b>3M</b> 40	2,6	21,8	3 M 40	04.85-01.96	3	<b>0 432 291 692</b>
				02.96→	3	<b>0 432 193 722</b>

**IVECO**

<b>8000</b>						
<b>8041</b> .05.300 [Aifo]	3,9	59	8041.05.300	01.85-12.89	4	<b>0 432 291 655</b>
<b>8061</b> .05.000, .05.300, .25.000, .25.010 [Aifo]	5,9	62-69/88/ 96/ 107-129	8061.05.000; 8061.05.300 <I 25>; 8061.25.000 <SI 25, SI 25.00>; 8061.25.010 <I 15>; 8061.25.010 <SI 05, SI 05.00>	01.85-12.00	6	<b>0 432 291 655</b>





<b>8100</b>						
<b>8131</b> .61.210 [Sofim]	1,8	38	8131.61.210	01.83-12.89	3	<b>0 432 297 034 0 986 430 144</b>
<b>8140</b> .21.235 [Sofim]	2,4	68	8140.21.235 <8141 SI 21>	06.87-12.89	4	<b>0 432 191 829</b>
<b>8141</b> .61.203, .67.203 [Sofim]	2,4	53/55	8141.61.203 <8141 I 000>; 8141.67.203 <8141 I 67>	10.84-12.89	4	<b>0 432 297 034 0 986 430 144</b>

<b>8300</b>						
<b>8360</b> .05.200 [Aifo]	8,1	118	8360.05.200 <C 00>	06.83-12.90	6	<b>0 432 281 710</b>
<b>8361</b> .05.500, .05.501 [Aifo]	8,1	118	8361.05.500 <I 000>; 8361.05.501 <I 001>	06.83-12.95	6	<b>0 432 281 710</b>
.25.510, .25.511 [Aifo]	8,1	154/184	8361.25.510 <SRI 10>; 8361.25.510 <SRI 15.25>; 8361.25.511 <SI 11>	05.84-12.99	6	<b>0 432 281 704</b>

**KHD**

<b>BF 4 L 1011</b>	2,7	53	BF 4 L 1011	01.92→	AGG,EM	4	<b>0 432 191 705</b>
					FZ	4	<b>0 432 191 696</b>
					TW	4	<b>0 432 191 706</b>
<b>BF 10 L 513</b>	16,0	278/294	BF 10 L 513	01.89→		10	<b>0 432 291 699</b>
<b>F 2 L 1011</b>	1,4	21	F 2 L 1011	01.92→	AGG,EM	2	<b>0 432 191 705</b>
					FZ	2	<b>0 432 191 697</b>
					TW	2	<b>0 432 191 706</b>
<b>F 4 L 912 F</b>	3,8	51	F 4 L 912 F	10.89→		4	<b>0 432 191 752</b>
<b>F 6 L 912</b>	5,7	74	F 6 L 912	07.92→		6	<b>0 432 191 787</b>
F	5,7	76	F 6 L 912 F	10.89→		6	<b>0 432 191 752</b>
<b>F 6 L 913</b>	6,1	89	F 6 L 913	02.91→		6	<b>0 432 191 787</b>

**LAMBORGHINI (S+L+H)**

<b>916</b> /3 W	2,8	45	916/3 W	01.84-01.87	3	<b>0 432 291 685</b>
/4 W	3,7	60	916/4 W	01.84-01.87	4	<b>0 432 291 685</b>
/6 W, /6 WT	5,5	81/90	916/6 W; 916/6 WT	01.87-03.88	6	<b>0 432 291 685</b>
<b>1000</b> .3 W	3,0	44	1000.3 W	01.87-12.99	3	<b>0 432 291 685</b>
.4 W, .4 WT	4,0	62/76	1000.4 W; 1000.4 WT	01.87-12.99	4	<b>0 432 291 685</b>

**LOMBARDINI**

<b>L 20</b> (8 LD 665.2, L)	1,3	13	L 20 <8 LD 665.2, L>	06.80-05.87	2	<b>9 430 032 170</b>
				06.87→	2	<b>0 432 291 624</b>
27 (5 LD 825.2L)	1,7	15	L 27 (5 LD 825.2L)	03.72-11.86	2	<b>0 432 281 791</b>
40 (5 LD 825.3L)	2,5	26,8	L 40 (5 LD 825.3L)	03.72-11.86	3	<b>0 432 281 791</b>
54 (5 LD 825.4L)	3,3	40	L 54 (5 LD 825.4L)	03.72-11.86	4	<b>0 432 281 791</b>
<b>LDA 832</b>	1,7	22,1	LDA 832	03.72-11.86	2	<b>0 432 281 791</b>
833 (5 LD 825.3)	2,5	38	LDA 833 (5 LD 825.3)	03.72-11.86	3	<b>0 432 281 791</b>
834 (5 LD 825.4)	3,3	44,1	LDA 834 (5 LD 825.4)	03.72-11.86	4	<b>0 432 281 791</b>
<b>LDW 1503</b>	1,6	25,5	LDW 1503 <CHD>	10.90→	3	<b>0 432 217 077</b>
<b>4 LD 640, 640/L</b>	0,6	6,6/7,9	4 LD 640 <LDA 96>; 4 LD 640/L <L 10>	06.87→	1	<b>0 432 281 689</b>
705	0,7	9,9	4 LD 705 <LDA 100>	06.87→	1	<b>0 432 281 689</b>
820, 820/L	0,8	9/11,8	4 LD 820 <LDA 820>; 4 LD 820/L <L 14>	06.87→	1	<b>0 432 281 689</b>
<b>6 LD 260 C</b>	0,3	3,3	6 LD 260/C	01.82-05.86	1	<b>9 430 032 192</b>
				06.86-07.92	1	<b>0 432 291 643</b>
<b>7 LD 665</b>	0,7	11	7 LD 665	01.84-05.87	1	<b>9 430 032 170</b>
				06.87→	1	<b>0 432 291 624</b>
665 F	0,7	9,9	7 LD 665 F <725>	01.82-05.87	1	<b>9 430 032 170</b>
				06.87→	1	<b>0 432 291 624</b>
665 I	0,7	9,9	7 LD 665 I <Ex 720>	01.82-05.87	1	<b>9 430 032 170</b>
				06.87→	1	<b>0 432 291 624</b>
740	0,7	12	7 LD 740	04.81-05.87	1	<b>9 430 032 170</b>
				06.87→	1	<b>0 432 291 624</b>
740 F	0,7	12	7 LD 740 F	05.86→	1	<b>0 432 291 624</b>





◀ LOMBARDINI

<b>8 LD 740.2</b>	0,7	21	8 LD 740.2	05.83-05.87	2	<b>9 430 032 170</b>
				06.87→	2	<b>0 432 291 624</b>
<b>9 LD 561.2</b>	1,1	19	9 LD 561.2	01.84-05.87	2	<b>9 430 032 170</b>
				06.87→	2	<b>0 432 291 624</b>
561.2 L	1,1	13	9 LD 561.2 L	01.84-05.87	2	<b>9 430 032 170</b>
				06.87→	2	<b>0 432 291 624</b>
561.2/2 W	1,1	13	9 LD 561.2/2 W	01.85-05.87	2	<b>9 430 032 170</b>
				06.87-11.87	2	<b>0 432 291 624</b>
				12.87→	2	<b>0 432 217 077</b>
625.2	1,3	21	9 LD 625.2	06.87→	2	<b>0 432 291 624</b>
<b>10 LD 400.2/B1</b>	0,8	12-13	10 LD 400.2/B1	01.84→	2	<b>0 432 291 642</b>
<b>11 LD 535.3</b>	1,6	25	11 LD 535.3	04.84-12.86	3	<b>9 430 032 170</b>
				01.87→	3	<b>0 432 291 624</b>
625.3	1,9	28	11 LD 625.3	04.84-12.86	3	<b>9 430 032 170</b>
				01.87→	3	<b>0 432 291 624</b>
<b>12 LD 435.2, 435.2/B1</b>	0,9	11/14	12 LD 435.2; 12 LD 435.2/B1	06.87→	2	<b>0 432 291 642</b>
<b>832</b>	1,7	25	832 <5 LD 825.2>	03.72→	2	<b>0 432 281 791</b>
<b>833</b>	2,7	33	833 <5 LD 825.3>	03.72→	3	<b>0 432 281 791</b>
<b>904</b>	1,2	15	904 <8 LD 600.2>	01.76-05.87	2	<b>9 430 032 170</b>
				06.87→	2	<b>0 432 291 624</b>
<b>914</b>	1,3	19	914 <8 LD 665.2>	01.76-05.87	2	<b>9 430 032 170</b>
				06.87→	2	<b>0 432 291 624</b>

**MAN**

<b>D 0226 MCE 51, MTE 51</b>	5,7		D 0226 MCE 51 <Schlüter>; D 0226 MTE 51 <Schlüter>	06.84-12.00	6	<b>0 432 231 774</b>
ME 74	5,7	74	D 0226 ME 74 <Schlüter>	02.83-12.00	6	<b>0 432 231 820</b>

**MERCEDES-BENZ**

<b>OM 314</b>	3,8	23-63	OM 314	04.71-12.88	4	<b>0 432 231 887</b>	<b>0 986 430 056</b>
<b>OM 352 A</b>	5,7	115	OM 352 A	06.82-11.87	6	<b>0 432 231 870</b>	
<b>OM 366 LA</b>	6,0	155	OM 366 LA <PPM-France>	09.90→	6	<b>0 432 231 724</b>	<b>0 986 430 221</b>
<b>OM 402</b>	12,8	188	OM 402 <Demag, Liebherr>	06.82-12.89 KZO	8	<b>0 432 231 792</b>	
<b>OM 403</b>	16,0	235	OM 403 <Demag, Liebherr>	06.85-12.89 KZO	10	<b>0 432 231 792</b>	
<b>OM 404</b>	21,0	316	OM 404 <Demag, Liebherr>	06.82-12.89 KZO	12	<b>0 432 231 792</b>	
<b>OM 441</b>	11,0	160	OM 441	10.89-01.91	6	<b>0 432 231 760</b>	<b>0 986 430 168</b>
				02.91→	6	<b>0 432 231 709</b>	
<b>OM 442</b>	15,0	206	OM 442	07.88-01.91	8	<b>0 432 231 760</b>	<b>0 986 430 168</b>
				02.91→	8	<b>0 432 231 709</b>	
<b>OM 447 h</b>	12,0	132	OM 447 h <Dänische, Privatbahn>	07.89-09.93	6	<b>0 432 231 743</b>	
				10.93→	6	<b>0 432 231 681</b>	
<b>OM 449 hLA</b>	10,0	185	OM 449 hLA	05.96-12.05	5	<b>9 430 082 768</b>	
<b>OM 603 A</b>	3,0	105	OM 603 A <Hägglunds>	09.89→	6	<b>0 432 217 266</b>	<b>0 986 430 247</b>

**MTU**

<b>6 V 396 TC- 4</b>	23,8	300	6 V 396 TC-4	10.88→	6	<b>0 432 231 734</b>	
<b>8 V 396 TC- 4</b>	31,7	400	8 V 396 TC- 4	10.88→	0	<b>0 432 231 734</b>	
<b>12 V 396 TC 4</b>	47,5	600	12 V 396 TC 4	08.88→	12	<b>0 432 231 046</b>	
					TW	12	<b>0 432 231 734</b>





l/ccm



kW/(PS)



Typ



Zyl.



## MWM-DIESEL

<b>D 226 -2</b>	2,1	16-30	D 226-2	10.72→	2	<b>0 432 291 029</b>
-3	3,1	24-46	D 226-3	10.72→	3	<b>0 432 291 029</b>
<b>D 234 V6</b>	10,8	165	D 234 V6	03.83→	6	<b>0 432 291 701</b>
<b>D 327 -2</b>	1,9	27	D 327-2 <12 V>	10.72→	2	<b>0 432 291 029</b>
-3	2,8	22-37	D 327-3 <12 V>	10.72→	3	<b>0 432 291 029</b>
-4	3,8	30-54	D 327-4 <12 V>	10.72→	4	<b>0 432 291 029</b>
-6	5,7	45-82	D 327-6 <12 V>	10.72→	6	<b>0 432 291 029</b>

## PERKINS

<b>T6 .354</b>	5,8	114	T 6.354	12.76-02.89	6	<b>0 432 291 762</b>
----------------	-----	-----	---------	-------------	---	----------------------

## RUGGERINI

<b>CRD 100/2 P</b>	1,5	26	CRD 100/2 P	11.75-12.86	2	<b>0 432 281 717</b>
951	0,7	11	CRD 951	11.75-12.86	1	<b>0 432 281 717</b>
				01.87-01.88	1	<b>0 432 291 657</b>
951/2	1,4	22	CRD 951/2	11.75-12.86	2	<b>0 432 281 717</b>
				01.87-01.88	2	<b>0 432 291 657</b>
<b>RF 80</b>	0,4	6	RF 80	09.81-12.86	1	<b>0 432 281 112</b>
				01.87→	1	<b>0 432 193 887</b>
81	0,3	6,5	RF 81	09.81-12.86	1	<b>0 432 281 112</b>
				01.87→	1	<b>0 432 193 887</b>
88	0,4	4	RF 88	01.87→	1	<b>0 432 193 887</b>
89	0,4	6	RF 89	03.83-12.86	1	<b>0 432 281 112</b>
				01.87-12.90	1	<b>0 432 193 887</b>
90	0,5	7,4	RF 90	11.85-12.86	1	<b>0 432 281 112</b>
				01.87→	1	<b>0 432 193 887</b>
91	0,5	8,1	RF 91	11.85-12.86	1	<b>0 432 281 112</b>
				01.87→	1	<b>0 432 193 887</b>
100	0,5	7,5	RF 100	09.81-12.86	1	<b>0 432 281 112</b>
				01.87-12.87	1	<b>0 432 193 887</b>
109	0,5	7,5	RF 109	03.83-01.86	1	<b>0 432 281 112</b>
120	0,5	7,5	RF 120	09.81-12.86	1	<b>0 432 281 112</b>
				01.87→	1	<b>0 432 193 887</b>
121	0,5	9,3	RF 121	09.85-12.86	1	<b>0 432 281 112</b>
				01.87→	1	<b>0 432 193 887</b>
129	0,5	9,3	RF 129	11.83-12.86	1	<b>0 432 281 112</b>
				01.87-12.90	1	<b>0 432 193 887</b>
130	0,6	9,5	RF 130	09.81-12.86	1	<b>0 432 281 112</b>
				01.87→	1	<b>0 432 193 887</b>
139	0,6	9,5	RF 139	03.83-01.86	1	<b>0 432 281 112</b>
<b>RP 170</b>	0,8	13	RP 170	04.83-12.86	1	<b>0 432 281 717</b>
				01.87→	1	<b>0 432 291 657</b>
178	0,7	15	RP 178	09.83→	1	<b>0 432 291 657</b>
368	1,7	20	RP 368	01.84→	2	<b>0 432 291 657</b>
380	1,7	28	RP 380	06.84-12.86	2	<b>0 432 281 717</b>
				01.87→	2	<b>0 432 291 657</b>





**SCANIA**

D 8	7,8	114	D 8	01.77-07.86	6	<b>0 432 292 886</b>
11	11,0	149	D 11	10.74-06.89	6	<b>0 432 281 748</b>
DC 12.41 A01	11,7		DC 12.41 A01	01.99→	6	<b>0 432 131 686</b>
DN 8.01 A	7,8	123	DN 8.01 A	01.83-06.89	6	<b>0 432 292 886</b>
9	8,5	128	DN 9			
			Mot.Nr. →5094162	04.86-06.89	6	<b>0 432 131 850 0 986 430 031</b>
			Mot.Nr. 5094163→	07.89-12.98	6	<b>0 432 131 850 0 986 430 031</b>
11	11,0	158	DN 11	03.85-06.91	6	<b>0 432 292 880</b>
DS 8, 8.01, 8.05	7,8	154/173	DS 8; DS 8.01; DS 8.05	12.79-12.94	6	<b>0 432 292 887</b>
9.01	8,5	136	DS 9.01 <Kockum>			
			Mot.Nr. →5094162	05.86-06.89	6	<b>0 432 131 850 0 986 430 031</b>
			Mot.Nr. 5094163→	07.89-12.98	6	<b>0 432 131 850 0 986 430 031</b>
		187	DS 9.01			
			Mot.Nr. →5094162	01.85-06.89	6	<b>0 432 131 850 0 986 430 031</b>
			Mot.Nr. 5094163→	07.89-12.98	6	<b>0 432 131 850 0 986 430 031</b>
11	11,0		DS 11	03.89-12.98	6	<b>0 432 131 871 0 986 430 120</b>
			DS 11 <Allvarv>	08.90-12.98	6	<b>0 432 131 871 0 986 430 120</b>
		202	DS 11	01.83-10.94	6	<b>0 432 292 879</b>
11.05, 11.15	11,0	224/232	DS 11.05; DS 11.15	04.81-12.98	6	<b>0 432 292 881 0 986 430 074</b>
11.54 A, 11.57 A	11,0	235	DS 11.54 A, 11.57 A	01.89-12.98	6	<b>0 432 131 871 0 986 430 120</b>
14	14,2	257	DS 14	04.80-02.93	8	<b>0 432 231 813</b>
14.42 A 24 S	14,2	294	DS 14.42 A 24 S	06.84-12.98 CSA	8	<b>0 432 231 799 0 986 430 039</b>
14.47 A..Q	14,2	334	DS 14.47 A..Q	03.89-05.89 CSA	8	<b>0 432 231 799 0 986 430 039</b>
				06.89-12.98	8	<b>0 432 131 873 0 986 430 030</b>
14.47 A..S	14,2	318-334	DS 14.47 A..S	12.88-05.89 CSA	8	<b>0 432 231 799 0 986 430 039</b>
				06.89-12.98	8	<b>0 432 131 873 0 986 430 030</b>
14.49 A..T	14,2	318-334	DS 14.49 A..T	01.89-12.98	8	<b>0 432 131 873 0 986 430 030</b>
DSC 11	11,0		DSC 11	06.89-12.03	6	<b>0 432 131 871 0 986 430 120</b>

**STEYR (STEYR-DAIMLER-PUCH AG)**

WD 408.45	3,1	46	WD 408.45	TR 05.89→	4	<b>0 432 291 623</b>
815.69	12,0	250	WD 815.69	06.90→	6	<b>0 432 191 773</b>

**VALMET**

<b>612</b>						
DSJ	7,4	165	612 DSJ <TD 170>	06.88-05.90	6	<b>0 432 292 876</b>
				TW	6	<b>0 432 292 875</b>
				06.90→	6	<b>0 432 292 866</b>
				TW	6	<b>0 432 292 867</b>

**VOLVO**

TD 102 FS	10,0	206	TD 102 FS	09.87-09.97	6	<b>0 432 191 771 0 986 430 166</b>
-----------	------	-----	-----------	-------------	---	------------------------------------

**VOLVO BM**

D 45 B	0,0		D 45 B <LM 622>	03.85→	4	<b>0 432 191 841</b>
TD 45	0,0		TD 45	11.88→	4	<b>0 432 191 758</b>
			TD 45 <P 703>	04.85→	4	<b>0 432 191 842</b>
45 B	4,5	82,5	TD 45 B	04.85→	4	<b>0 432 191 842</b>
		84	TD 45 B <Bagger6300>	11.91→	4	<b>0 432 191 758</b>
45 E	4,5	84	TD 45 E <Bag EL 70>	04.93→	4	<b>0 432 191 722</b>
		84-92	TD 45 E <Bagger6300, L70>	11.91→	4	<b>0 432 191 722</b>
45 EM	0,0	85	TD 45 EM <LM 4300 U>	01.86→	4	<b>0 432 191 813</b>





<b>TD</b> 60 B	0,0		TD 60 B <LM 4400>	01.86-09.86	0	<b>0 432 191 864</b>	
60 LLK	0,0	125	TD 60 LLK	01.86-09.86	0	<b>0 432 191 868</b>	<b>0 986 430 492</b>
61	0,0		TD 61 <LM 4400 B>	01.86→	6	<b>0 432 191 801</b>	<b>0 986 430 494</b>
	5,5	107-122	TD 61 <H7,H10 Bag>	10.92→	6	<b>0 432 191 807</b>	
61 GD	5,5	92	TD 61 GD <Lader L 70>	02.93→	6	<b>0 432 191 671</b>	
61 KBE	5,5	119	TD 61 KBE <L 90, 190>	09.91→	6	<b>0 432 191 717</b>	
61/2	0,0		TD 61/2 <LM 4400>	01.86→	0	<b>0 432 191 801</b>	<b>0 986 430 494</b>
63 KBE, 63 KDE	5,5	88-94/ 115-118	TD 63 KBE <L 90, L 90 C, Lader>; TD 63 KDE <L 70, L 70 C, Lader>	10.93→	6	<b>0 432 191 658</b>	<b>0 986 430 498</b>
<b>TJD</b> 121 G	0,0	243	TJD 121 G <P 505>	06.87→	6	<b>0 432 191 863</b>	<b>0 986 430 032</b>

## VOLVO PENTA

<b>TAMD</b> 102	9,6	324	TAMD 102	06.90→	6	<b>0 432 191 788</b>	<b>0 986 430 167</b>
102 A	10,0	309	TAMD 102 A	02.92→	0	<b>0 432 191 708</b>	
122 A, 122 AG	12,0	320-355	TAMD 122 A <HD>; TAMD 122 AG <Schiff>	03.88→	6	<b>0 432 191 788</b>	<b>0 986 430 167</b>
162 AG	16,0	350-370	TAMD 162 AG <Schiff>	07.91→	6	<b>0 432 291 635</b>	<b>0 986 430 169</b>
<b>TD</b> 31	0,0		TD 31	05.86→	0	<b>0 432 191 795</b>	
42 A	3,6	170	TD 42 A	10.90→	6	<b>0 432 193 861</b>	
60 B	5,5	112	TD 60 B <Akermann>	06.82-06.86	6	<b>0 432 191 870</b>	
		130	TD 60 B	03.82-06.86	6	<b>0 432 191 855</b>	
		173	TD 60 B	10.78-06.86	6	<b>0 432 191 865</b>	
60 BG	5,5	82	TD 60 BG	09.83-06.86	0	<b>0 432 191 870</b>	
60 D	5,5	118	TD 60 D	01.82-06.86	6	<b>0 432 191 855</b>	
60 DG	5,5	86	TD 60 DG	09.83-06.86	6	<b>0 432 191 870</b>	
61 A	5,5	147	TD 61 A	06.86→	6	<b>0 432 191 806</b>	
					TW	6	<b>0 432 191 807</b>
61 ACE	5,5	112	TD 61 ACE <Akermann>	06.86→	6	<b>0 432 191 822</b>	<b>0 986 430 162</b>
		120	TD 61 ACE <Akermann>	01.91→	6	<b>0 432 191 807</b>	
61 AG	5,5		TD 61 AG	06.86→	6	<b>0 432 191 806</b>	
					TW	6	<b>0 432 191 807</b>
		93	TD 61 AG	03.91→	6	<b>0 432 191 806</b>	
61 APP	5,8	147	TD 61 APP	06.86→	6	<b>0 432 191 822</b>	<b>0 986 430 162</b>
61 AW	5,5	125	TD 61 AW	06.86→	6	<b>0 432 191 806</b>	
		132	TD 61 AW	06.86→	6	<b>0 432 191 806</b>	
					TW	6	<b>0 432 191 807</b>
70, 70 GG	6,7	175	TD 70; TD 70 GG	03.83→	6	<b>0 432 191 854</b>	<b>0 986 430 002</b>
71 A, 71 APP	6,7	165	TD 71 A; TD 71 APP	10.85→	6	<b>0 432 191 805</b>	
71 ACE	6,7	155	TD 71 ACE <Akermann>	10.85→	6	<b>0 432 191 806</b>	
71 AW	6,7	150	TD 71 AW	10.85→	6	<b>0 432 191 807</b>	
100 G	9,6	203	TD 100 G	06.83→	6	<b>0 432 191 848</b>	<b>0 986 430 000</b>
				03.87→	6	<b>0 432 191 815</b>	<b>0 986 430 164</b>
100 GG	9,6	154/179	TD 100 GG	06.83-09.91	6	<b>0 432 191 848</b>	<b>0 986 430 000</b>
				06.83→	6	<b>0 432 191 848</b>	<b>0 986 430 000</b>
120 BHC, BRC	12,0	192	TD 120 BHC, BRC	01.84→	6	<b>0 432 191 813</b>	
121 G, 121 GG, 1210 G	12,0	199/230/ 256	TD 121 G; TD 121 GG; TD 1210 G	01.84→	6	<b>0 432 191 863</b>	<b>0 986 430 032</b>
122 KHE	12,0	209	TD 122 KHE <L 180 E>	02.92→	6	<b>0 432 191 773</b>	<b>0 986 430 353</b>
610 M	5,5	147	TD 610 M	10.91→	6	<b>0 432 191 806</b>	
710 G	6,7	141	TD 710 G	10.91→	6	<b>0 432 191 805</b>	
1010 G	10,0	188	TD 1010 G	11.91→	6	<b>0 432 191 815</b>	<b>0 986 430 164</b>
<b>TID</b> 61 AG	5,5		TID 61 AG	01.86→	6	<b>0 432 191 806</b>	
70 GG	6,7		TID 70 GG	01.86-09.91	6	<b>0 432 191 854</b>	<b>0 986 430 002</b>
71 A	6,7	188	TID 71 A	01.86→	6	<b>0 432 191 806</b>	
100 K	10,0	225	TID 100 K	06.84-11.90	6	<b>0 432 191 848</b>	<b>0 986 430 000</b>
121 K, 121 KG	12,0	250/253	TID 121 K; TID 121 KG	01.86→	6	<b>0 432 191 863</b>	<b>0 986 430 032</b>
121 LG, 121 LP	12,0	295/302	TID 121 LG; TID 121 LP	01.86→	6	<b>0 432 191 808</b>	
<b>TWD</b> 1010 G	10,0	212	TWD 1010 G	02.92→	6	<b>0 432 191 834</b>	
1210 G	12,0	294-313	TWD 1210 G	09.91→	6	<b>0 432 191 808</b>	
1620 G	16,0	400	TWD 1620 G	11.91→	6	<b>0 432 291 635</b>	<b>0 986 430 169</b>

**VW (VOLKSWAGEN)**

<b>028.B</b>	1,9	35	028.B <M 344/M840>	07.90-07.05	4	<b>0 432 217 210</b>	
.Z JG5	1,9	55	028.Z JG5	05.93→	4	<b>0 432 217 232</b>	
<b>068.1</b> 50Hz, 60Hz	1,6	33	068.1 50Hz <CK>; 068.1 60Hz <CK>	04.82-04.97	4	<b>0 432 217 083</b>	<b>0 986 430 081</b>
<b>068.4</b> , 50 Hz, 60 Hz	1,6	51	068.4; 068.4 50Hz; 068.4 60Hz	07.81-07.96	4	<b>0 432 217 083</b>	<b>0 986 430 081</b>
<b>068.5</b> , 50 Hz, 60 Hz	1,6	36	068.5; 068.5 50Hz; 068.5 60Hz	07.81-07.96	4	<b>0 432 217 083</b>	<b>0 986 430 081</b>
<b>075.1</b>	2,4	55	075.1	04.83-04.98	6	<b>0 432 217 083</b>	<b>0 986 430 081</b>
					6	<b>0 432 217 084</b>	<b>0 986 430 081</b>
50 Hz	2,4	55	075.1 50Hz	04.83-04.98	6	<b>0 432 217 083</b>	<b>0 986 430 081</b>
					6	<b>0 432 217 084</b>	<b>0 986 430 081</b>
60 Hz	2,4	55	075.1 60Hz	04.83-04.98	6	<b>0 432 217 083</b>	<b>0 986 430 081</b>
					6	<b>0 432 217 084</b>	<b>0 986 430 081</b>
<b>075.2</b> , 50 Hz	2,4	75	075.2; 075.2 50Hz	04.83-04.98	6	<b>0 432 217 079</b>	<b>0 986 430 080</b>
<b>076.1</b> , 50 Hz, 60 Hz	2,4	54	076.1; 076.1 50Hz; 076.1 60Hz	07.82-07.97	6	<b>0 432 217 077</b>	





l/ccm



kW/(PS)



Typ



Zyl.



## ALFA ROMEO

**Brera**

2.0 JTDM [939]	2,0	125	939B3000 <M120>	05.09→	DBJ	4	0 445 110 299	
2.4 JTDM 20V [939]	2,4	147	939A3000 <M95>	04.06→	DBJ	5	0 445 110 213	0 986 435 162
		154	939A9000 <M105>	05.07→	DBJ	5	0 445 110 308	

**Giulietta**

1.6 JTDM [191]	1,6	77	940A3000	05.10→	DBJ	4	0 445 110 300	
2.0 JTDM [191]	2,0	103/125	940A4000; 940A5000	05.10→	DBJ	4	0 445 110 299	

**GT**

1.9 JTD 16V [937]	1,9	103	937A5000 <M15>	10.03→	DBB	4	0 445 110 111	0 986 435 081
		110/125	937A5000 <M92>; 937A6000 <M94>	01.04→	DBB	4	0 445 110 243	0 986 435 104

**Mito**

1.3 JTD [145]	1,3	66	199A3000 <M72>	10.08→	DBB	4	0 445 110 183	0 986 435 102
		70	199B1000 <M95>	10.08→	DBJ	4	0 445 110 351	
1.6 JTD [145]	1,6	84/88	955A3000 <M88>; 955A4000 <M87>	08.08→	DBJ	4	0 445 110 300	

**Spider**

2.0 JTDM [939]	2,0	125	939B3000 <M120>	05.09-12.10	DBJ	4	0 445 110 299	
2.4 JTDM 20V [939]	2,4	147	939A3000 <M95>	03.07-12.10	DBJ	5	0 445 110 213	0 986 435 162
		154	939A3000 <M105>	03.08-12.10	DBJ	5	0 445 110 308	

**145**

1.9 JTD [930 MY97]	1,9	76	AR 32302 <M20>	05.98-02.99	DBB	4	0 445 110 002	0 986 435 001
JTD [930 MY99]	1,9	76	AR 32302 <M20>	02.99-12.00	DBB	4	0 445 110 002	0 986 435 001

**146**

1.9 JTD [930 MY97]	1,9	76	AR 32302 <M13>	05.98-02.99	DBB	4	0 445 110 002	0 986 435 001
JTD [930 MY99]	1,9	76	AR 32302 <W4 M20>	02.99-12.00	DBB	4	0 445 110 002	0 986 435 001

**147**

1.9 JTD [937]	1,9	74	182B9000 <M14>	06.03-10.06	DBB	4	0 445 110 119	0 986 435 083
		81-85	937A2000 <M15>	11.00-03.05	DBB	4	0 445 110 119	0 986 435 083
JTDM [937]	1,9	85	939A7000 <M87>	01.06-12.10	DBB	4	0 445 110 276	0 986 435 148
		88	937A3000 <M88>	04.05-12.10	DBB	4	0 445 110 276	0 986 435 148
JTDM 16V [937]	1,9	93	937A4000 <M16>	06.03-09.06	DBB,EU3	4	0 445 110 111	0 986 435 081
		100/110	192B1000 <M18>; 937A5000 <M19>	02.04-12.05	DBB,EU3	4	0 445 110 111	0 986 435 081
			192B1000 <M91>; 937A5000 <M92>	06.05-12.10	DBB	4	0 445 110 243	0 986 435 104
		103	192A5000 <M17>	10.02-09.03	DBB	4	0 445 110 111	0 986 435 081
		125	937A6000 <M94>	10.07-12.10	DBJ	4	0 445 110 341	

**156 Berlina**

1.9 JTD [932]	1,9	74	182B9.000 <M24>	06.03-12.04	DBB	4	0 445 110 119	0 986 435 083
		76	AR32302 <M1>	10.97-09.00	DBB	4	0 445 110 002	0 986 435 001
		81-85	AR37101 / 937A2.000 <M3/M5>					
			Mot.Nr. 2760402→	09.00-12.01	DBB	4	0 445 110 119	0 986 435 083
		85	937A2.000 <M25>	01.02-10.05	DBB	4	0 445 110 119	0 986 435 083
JTD 16V [932]	1,9	93/100	192B1000 <M29>; 937A4.000 <M26>	06.03-10.05	DBB	4	0 445 110 111	0 986 435 081
		103	192A5.000 <M27>	10.02-10.05	DBB	4	0 445 110 111	0 986 435 081
2.4 JTD [932]	2,4	100	AR32501 <M2>	10.97-09.00	DBB	5	0 445 110 002	0 986 435 001
			839A6.000 <M4>					
			Mot.Nr. 2760402→	09.00-12.01	DBB	5	0 445 110 119	0 986 435 083
		110	841C000 <M30>	01.02-10.05	DBB	5	0 445 110 119	0 986 435 083
JTD, JTD 20V [932]	2,4	120/129	841G.000 <M31>; 841M000 <M33>	06.03-10.05	DBB	5	0 445 110 111	0 986 435 081

**156 Cross Wagon Q4**

1.9 JTD 4x4 [932]	1,9	110	937A5000 <M28 / M92>	10.04-12.05	DBB,EU3	4	0 445 110 111	0 986 435 081
				06.05-12.05	DBB,EU4	4	0 445 110 243	0 986 435 104

**156 Sport Wagon**

1.9 JTD [932]	1,9	74	182B9.000 <M24>	06.03-12.04	DBB	4	0 445 110 119	0 986 435 083
		76	AR32302 CF2 <M1>	06.00-09.00	DBB	4	0 445 110 002	0 986 435 001
		80-85	AR37101 / 937A2.000 <M3/M5 CF3>					
			Mot.Nr. →2760401	09.00-12.01	DBB	4	0 445 110 068	0 986 435 083
			Mot.Nr. 2760401→	10.01-12.01	DBB	4	0 445 110 119	0 986 435 083
		85	937A2.000 <M25>	01.02-12.05	DBB	4	0 445 110 119	0 986 435 083
JTD 16V [932]	1,9	93	937A4.000 <M26/M90>	06.03-10.05	DBB	4	0 445 110 111	0 986 435 081
		93/110	937A4000 <M90>; 937A5000 <M82 E4>	10.03-12.05	DBB	4	0 445 110 243	0 986 435 104
		100	192B1000 <M29>	10.04-10.05	DBB	4	0 445 110 111	0 986 435 081
		103	192A5.000 <M27>	10.02-12.05	DBB	4	0 445 110 111	0 986 435 081



A



◀ ALFA ROMEO

2.4 JTD [932]	2,4	100	AR32501 CF2 <M2> 839A6.000 CF3 <M4>	06.00-09.00	DBB	5	0 445 110 002	0 986 435 001
			Mot.Nr. →2760401	09.00-12.01	DBB	5	0 445 110 068	0 986 435 083
			Mot.Nr. 2760401→	10.01-12.01	DBB	5	0 445 110 119	0 986 435 083
		110	841C000 <M30>	01.02-10.05	DBB	5	0 445 110 119	0 986 435 083
JTD, JTD 20V [932]	2,4	120/129	841G000 <M31>; 841M000 <M33>	06.03-12.05	DBB	5	0 445 110 111	0 986 435 081
<b>156 Sport Wagon Q4</b>								
1.9 JTD 16V 4x4 [932]	1,9	110	937A5000 <M28 / M92>	10.04-12.05	DBB,EU3	4	0 445 110 111	0 986 435 081
				06.05-12.05	DBB,EU4	4	0 445 110 243	0 986 435 104
<b>159</b>								
2.0 JTDM 16V [939..]	2,0	100		06.10→	DBJ	4	0 445 110 299	
<b>159 Berlina</b>								
1.9 JTDM 8V [939]	1,9	85	937A7000 <M87 E4>	01.06-12.08	DBB	4	0 445 110 244	0 986 435 161
		88	939A1000 <M88 E4>	06.05-12.08	DBB	4	0 445 110 244	0 986 435 161
JTDM 16V [939]	1,9	100	937A8000 <M91>	01.06-12.08	DBB	4	0 445 110 243	0 986 435 104
		110	939A2000 <M92 E4>	06.05-12.08	DBB	4	0 445 110 243	0 986 435 104
2.0 JTDM 16V [939]	2,0	125	939B3000 <M120>	05.09-12.10	DBJ	4	0 445 110 299	
2.4 JTD 20V [939]	2,4	154	939A9000 <M105>	02.07-12.08	DBJ	5	0 445 110 308	
JTDM 20V [939]	2,4	147	939A3000 <M95 E4>	06.05-12.08	DBJ	5	0 445 110 213	0 986 435 162
<b>159 Berlina Q4</b>								
2.4 JTD 20V [939]	2,4	154	939A9000 <M110>	09.06-12.08	DBJ	5	0 445 110 308	
<b>159 Sport Wagon</b>								
1.9 JTDM 8V [939]	1,9	85/88	937A7000 <M87 E4>; 939A1000 <M88 E4>	03.06-12.08	DBB	4	0 445 110 244	0 986 435 161
JTDM 16V [939]	1,9	100/110	937A8000 <M91>; 939A2000 <M92 E4>	03.06-12.08	DBB	4	0 445 110 243	0 986 435 104
2.0 JTDM 16V [939..]	2,0	100		06.10→	DBJ	4	0 445 110 299	
JTDM 16V [939]	2,0	125	939B3000 <M120>	05.09-12.10	DBJ	4	0 445 110 299	
2.4 JTD 20V [939]	2,4	154	939A9000 <M105>	02.07-12.08	DBJ	5	0 445 110 308	
JTDM 20V [939]	2,4	147	939A3000 <M95 E4>	03.06-12.08	DBJ	5	0 445 110 213	0 986 435 162
<b>159 Sport Wagon Q4</b>								
2.4 JTD 20V [939]	2,4	154	939A9000 <M110>	09.06-12.08	DBJ	5	0 445 110 308	
<b>166</b>								
2.4 JTD [936]	2,4	100	AR 34202 <M20>	10.98-09.00	DBB	5	0 445 110 002	0 986 435 001
		100-110	839A6000 / 841C000 <M21/M22>					
			Mot.Nr. →2760400	09.00-09.01	DBB	5	0 445 110 068	0 986 435 083
			Mot.Nr. 2760401→	10.01-10.07	DBB	5	0 445 110 119	0 986 435 083
JTD 20V [936]	2,4	120/128/129	841G000 / 841H000 <M25/M26>; 841M000 <M27>; 841N000 <M28>	06.03-10.07	DBB	5	0 445 110 111	0 986 435 081
JTDM 20V [936]	2,4	132-136	936B000 <M99>	10.05-10.07	DBJ	5	0 445 110 213	0 986 435 162

**AUDI**

**A1**

2.0 TDI [8X1]	2,0	100/105	CFHB <D92>; CFHD <D92>	09.11→	DBJ	4	0 445 110 368	0 986 435 166
---------------	-----	---------	------------------------	--------	-----	---	---------------	---------------

**A1 Sportback**

2.0 TDI [8XA]	2,0	100/105	CFHB <D92>; CFHD <D92>	09.11→	DBJ	4	0 445 110 368	0 986 435 166
---------------	-----	---------	------------------------	--------	-----	---	---------------	---------------

**A3**

2.0 TDI, TDI quattro [8P1]	2,0	100/103/125	CBAA; CBAB; CBAB <D91>; CBBB <D93>	07.08-05.10	DBJ	4	0 445 116 029	0 986 435 360
----------------------------	-----	-------------	------------------------------------	-------------	-----	---	---------------	---------------

			CFFA <D94>; CFFB <D91>; CFGB <D93>; CLJA <D91>	11.09→	DBJ	4	0 445 110 368	0 986 435 166
--	--	--	--	--------	-----	---	---------------	---------------

**A3 Cabriolet**

2.0 TDI [8P7]	2,0	100/103	CBAA <D94>; CBAB <D91>	04.08-05.10	DBJ	4	0 445 116 029	0 986 435 360
---------------	-----	---------	------------------------	-------------	-----	---	---------------	---------------

			CFFA; CFFB	11.09→	DBJ	4	0 445 110 368	0 986 435 166
--	--	--	------------	--------	-----	---	---------------	---------------

**A3 Sportback**

2.0 TDI, TDI quattro [8PA]	2,0	100/103/125	CBAA <D94>; CBAB <D91>; CBBB <D93>	07.08-05.10	DBJ	4	0 445 116 029	0 986 435 360
----------------------------	-----	-------------	------------------------------------	-------------	-----	---	---------------	---------------

			CFFA <D94>; CFFB <D91>; CFGB <D93>; CLJA <D91>	11.09→	DBJ	4	0 445 110 368	0 986 435 166
--	--	--	--	--------	-----	---	---------------	---------------





<b>A4</b>									
2.0 TDI [8K2; B8]	2,0	100	CJCB <D94>	11.10→	DBJ	4	0 445 110 368	0 986 435 166	
TDI, TDI quattro [8K2; B8]	2,0	88/100/ 105/120/ 125	CAGA <D92>; CAGB <D94>; CAGC <D90>; CAHA <D93>; CAHB <D95>; CMEA <D92>	11.07→	DBJ	4	0 445 116 029	0 986 435 360	
2.7 TDI [8EC; B7]	2,7	120/132	BPP; BSG	11.05-06.08	DBJ	6	0 445 115 080	0 986 435 353	0 986 435 388
TDI [8K2; B8]	2,7	120/140	CAMA <D4V>; CAMB <D4V>; CGKA <D4V>; CGKB	11.07→	DBJ	6	0 445 116 022	0 986 435 357	
3.0 TDI quattro [8EC; B7]	3,0	150/171	ASB; BKN	01.05-06.08	DBJ	6	0 445 115 078	0 986 435 358	
TDI quattro [8K2; B8]	3,0	155/176 176	CCWA <D50>; CCWB <D1V> CAPA	06.08→	DBJ	6	0 445 116 022	0 986 435 357	
			Fg.Nr. →8K..8A040 000 →8K..8N015 000	11.07-03.08	DBJ	6	0 445 115 085	0 986 435 364	0 986 435 374
			Fg.Nr. 8E..8A040 001→ 8K..8N015 001→	04.08-05.08	DBJ	6	0 445 116 022	0 986 435 357	
			CCLA	11.09→	DBJ	6	0 445 117 002	0 986 435 380	
<b>A4 Avant</b>									
2.0 TDI [8K5; B8]	2,0	100	CJCB <D94>	11.10→	DBJ	4	0 445 110 368	0 986 435 166	
TDI, TDI quattro [8K5; B8]	2,0	88/100/ 105/120/ 125	CAGA <D92>; CAGB <D94>; CAGC <D90>; CAHA <D93>; CAHB <D95>; CMEA <D92>	04.08→	DBJ	4	0 445 116 029	0 986 435 360	
2.7 TDI [8ED; B7]	2,7	120/132	BPP; BSG	11.05-06.08	DBJ	6	0 445 115 080	0 986 435 353	0 986 435 388
TDI [8K5; B8]	2,7	120/140	CAMA <D4V>; CAMB <D4V>; CGKA; CGKB	04.08→	DBJ	6	0 445 116 022	0 986 435 357	
3.0 TDI quattro [8ED; B7]	3,0	150/171	ASB; BKN	01.05-06.08	DBJ	6	0 445 115 078	0 986 435 358	
TDI quattro [8K5; B8]	3,0	155/176 176	CAPA <D50>; CCWA <D50>; CCWB <D1V> CCLA	04.08→	DBJ	6	0 445 116 022	0 986 435 357	
				11.09→	DBJ	6	0 445 117 002	0 986 435 380	
<b>A4 Avant Allroad</b>									
2.0 TDI [8KH]	2,0	100/105/ 120/125	CAGA <D92>; CAGB <D94>; CAHA <D93>; CAHB <D95>	04.09→	DBJ	4	0 445 116 029	0 986 435 360	
3.0 TDI [8KH]	3,0	176	CCWA <D50>	04.09→	DBJ	6	0 445 116 022	0 986 435 357	
<b>A4 Cabriolet</b>									
2.7 TDI [8HE; B7]	2,7	132	BPP	11.05-03.09	DBJ	6	0 445 115 080	0 986 435 353	0 986 435 388
3.0 TDI quattro [8HE; B7]	3,0	150/171	ASB; BKN	01.06-03.09	DBJ	6	0 445 115 078	0 986 435 358	
<b>A5 Cabriolet</b>									
2.0 TDI [8F7]	2,0	120/125	CAHA <D93>; CAHB <D95>	05.09→	DBJ	4	0 445 116 029	0 986 435 360	
TDI, TDI quattro [8F7]	2,0	105/120/ 130	CGLC <DE2>; CGLD <D95>; CJCA <D92>	10.11→	DBJ	4	0 445 110 368	0 986 435 166	
2.7 TDI [8F7]	2,7	120/140	CGKA <D4V>; CGKB <D1W>	03.09→	DBJ	6	0 445 116 022	0 986 435 357	
3.0 TDI [8F7]	3,0	150	CLAB <D1Q>	09.11→	DBJ	6	0 445 117 021		
TDI quattro [8F7]	3,0	176 180	CCWA <D50> CDUC <D43>	03.09→	DBJ	6	0 445 116 022	0 986 435 357	
				10.11→	DBJ	6	0 445 116 039		
<b>A5 Coupé</b>									
2.0 TDI, TDI quattro [8T3]	2,0	120/125 120/130	CAHA <D93>; CAHB <D95> CGLC <DE2>; CGLD <D95>	01.08→	DBJ	4	0 445 116 029	0 986 435 360	
				08.11→	DBJ	4	0 445 110 368	0 986 435 166	
2.7 TDI [8T3]	2,7	120/140	CAMA <D4V>; CAMB <D1W>; CGKA <D4V>; CGKB <D1W>	07.07→	DBJ	6	0 445 116 022	0 986 435 357	
3.0 TDI [8T3]	3,0	150	CLAB <D1Q>	10.11→	DBJ	6	0 445 117 021		
TDI quattro [8T3]	3,0	155	CCWB <D1V>	03.08-05.10	DBJ	6	0 445 116 022	0 986 435 357	
			PR-Nr. 7MB	03.08-05.10	DBJ	6	0 445 115 085	0 986 435 364	0 986 435 374
		176	CAPA <D50>						
			PR-Nr. 7MB	06.07-05.08	DBJ	6	0 445 115 085	0 986 435 364	0 986 435 374
			PR-Nr. 7MG	06.07-05.08	DBJ	6	0 445 116 022	0 986 435 357	
			CCWA <D50>	03.08→	DBJ	6	0 445 116 022	0 986 435 357	
			PR-Nr. 7MB	03.08→	DBJ	6	0 445 115 085	0 986 435 364	0 986 435 374
		180	CDUC <D43>	08.11→	DBJ	6	0 445 116 039		





◀ AUDI

A5 Sportback									
2.0	TDI [8TA]	2,0	100/105/120/130	CGLC <DE2>; CGLD <D95>; CJCA <D92>; CJCB <D94>; CMFA <D92>	08.11→	DBJ	4	0 445 110 368	0 986 435 166
	TDI, TDI quattro [8TA]	2,0	100/105/120/125	CAGA <D92>; CAGB <D94>; CAHA <D93>; CAHB <D95>; CMEA <D92>	09.09→	DBJ	4	0 445 116 029	0 986 435 360
2.7	TDI [8TA]	2,7	120/140	CGKA <D4V>; CGKB <D1W>	09.09→	DBJ	6	0 445 116 022	0 986 435 357
3.0	TDI [8TA]	3,0	150	CLAB <D1Q>	10.11→	DBJ	6	0 445 117 021	
	TDI quattro [8TA]	3,0	155/176/180	CCWA <D50>; CCWB <D1V>; CDUC <D43>	05.09→ 08.11→	DBJ DBJ	6 6	0 445 116 022 0 445 116 039	0 986 435 357
A6									
2.0	TDI [4G2; C7]	2,0	100/120/130	CGLC <DE2>; CGLD <D95>; CGLE <D94>; CMGB <DE2>	02.11→	DBJ	4	0 445 110 368	0 986 435 166
	TDI, TDI e [4F2; C6]	2,0	100/120/125	CAGB <D94>; CAHA <D93>; CAHB <D95>	10.08→	DBJ	4	0 445 116 029	0 986 435 360
2.7	TDI, TDI quattro [4F2; C6]	2,7	120/132	BPP; BSG	11.04-10.08	DBJ	6	0 445 115 080	0 986 435 353 0 986 435 388
			120/140	CANA <D4V>; CANB; CANC <D4V>; CAND <D1W>	10.08→	DBJ	6	0 445 116 022	0 986 435 357
3.0	TDI quattro [4F2; C6]	3,0	155/165/171	ASB; BMK; BNG	04.04-10.08	DBJ	6	0 445 115 078	0 986 435 358
	TDI quattro [4G2; C7]	3,0	155/176/180/230	CDYA <D50>; CDYB <D1V>; CDYC <D50>; CDUC <D43>; CGQB <DD3>	10.08→ 11.10→ 12.11→	DBJ DBJ DBJ	6 6 6	0 445 116 022 0 445 116 039 0 445 117 028	0 986 435 357
	TDI, TDI quattro [4G2; C7]	3,0	150	CLAA <D1Q>; CLAB <D1Q>	11.10→	DBJ	6	0 445 117 021	
A6 Avant									
2.0	TDI [4G5; C7]	2,0	100/120/130	CGLC <DE2>; CGLD <D95>; CGLE <D94>; CMGB <DE2>	05.11→	DBJ	4	0 445 110 368	0 986 435 166
	TDI, TDI e [4F5; C6]	2,0	100/120/125	CAGB <D94>; CAHA <D93>; CAHB <D95>	10.08→	DBJ	4	0 445 116 029	0 986 435 360
2.7	TDI, TDI quattro [4F5; C6]	2,7	120/132	BPP; BSG	03.05-10.08	DBJ	6	0 445 115 080	0 986 435 353 0 986 435 388
			120/140	CANA <D4V>; CANB; CANC <D4V>; CAND <D1W>	10.08→	DBJ	6	0 445 116 022	0 986 435 357
3.0	TDI [4G5; C7]	3,0	150/180	CLAA <D1Q>; CLAB <D1Q>; CDUC <D43>	05.11→ 05.11→	DBJ DBJ	6 6	0 445 117 021 0 445 116 039	
	TDI quattro [4F5; C6]	3,0	155/165/171	ASB; BMK; BNG	03.05-10.08	DBJ	6	0 445 115 078	0 986 435 358
			155/176	CDYA <D50>; CDYB <D1V>; CDYC <D50>	10.08→	DBJ	6	0 445 116 022	0 986 435 357
A6 Avant Allroad									
2.7	TDI [4FH; C6]	2,7	120/132	BPP <D1N>; BSG <D1W>	05.06-10.08	DBJ	6	0 445 115 080	0 986 435 353 0 986 435 388
			120/140	CANC <D4V>; CAND <D1W>	10.08→	DBJ	6	0 445 116 022	0 986 435 357
3.0	TDI [4FH; C6]	3,0	155/171/155/176	ASB <D1D>; BNG <D1V>; CDYA <D50>; CDYB <D1V>; CDYC <D50>	05.06-10.08 10.08→	DBJ DBJ	6 6	0 445 115 078 0 445 116 022	0 986 435 358 0 986 435 357
A7 Sportback									
3.0	TDI quattro [4GA]	3,0	180/230	CDUC <TF1>; CGQB <DD3>	07.10→ 11.11→	DBJ DBJ	6 6	0 445 116 039 0 445 117 028	
	TDI, TDI quattro [4GA]	3,0	150	CLAA <D1Q>; CLAB <D1Q>	11.10→	DBJ	6	0 445 117 021	
A8									
3.0	TDI quattro [4E; D3]	3,0	155/171	ASB; BNG	11.03-07.10	DBJ	6	0 445 115 078	0 986 435 358
	TDI quattro [4H; D4]	3,0	150/155/184	CLAB <D1Q>; CDTA; CDTB <D1V>	09.11→ 07.10→	DBJ DBJ	6 6	0 445 117 021 0 445 116 039	
3.3	TDI quattro [4D2; D2]	3,3	165	AKF	12.99-08.02	DBJ	8	0 445 110 113	
4.0	TDI quattro [4E; D3]	4,0	202	ASE	05.03-07.05	DBJ	8	0 445 110 158	0 986 435 169
4.2	TDI quattro [4E; D3]	4,2	235/240	BMC; BVN	01.05-07.10	DBJ	8	0 445 115 085	0 986 435 364 0 986 435 374
Q3									
2.0	TDI, TDI quattro [8UB]	2,0	100/103/120/130	CFFA <D94>; CFFB <D91>; CFGC <DE2>; CFGD <D95>; CLLB <DE2>	06.11→	DBJ	4	0 445 110 368	0 986 435 166
Q5									
2.0	TDI quattro [8RB]	2,0	100/105/120/125	CAGA <D92>; CAGB <D94>; CAHA <D93>; CAHB <D95>	11.08-09.10	DBJ	4	0 445 116 029	0 986 435 360





<b>2.0</b> TDI, TDI quattro [8RB]	2,0	100/105/ 120/125	CGLA <D95>; CGLB <D93>; CJCA <D92>; CJCB <D94>	05.10→	DBJ	4	<b>0 445 110 368</b>	<b>0 986 435 166</b>
<b>3.0</b> TDI quattro [8RB]	3,0	155/176	CCWA <D50>; CCWB <D1V>	11.08→	DBJ	6	<b>0 445 116 022</b>	<b>0 986 435 357</b>
<b>Q7</b>								
<b>3.0</b> TDI [4LB]	3,0	150/176/ 180	CJGA <D50>; CJGC <D1Q>; CJGD <D43>; CJMA <D1Q>; CLZB <D43>; CRCA <D43>	05.10→	DBJ	6	<b>0 445 117 021</b>	
		155/171	BUG <D1D>; BUN <D1V>	03.06-05.08	DBJ	6	<b>0 445 115 078</b>	<b>0 986 435 358</b>
		155/176	CASA <D50>; CASB <D1V>	09.07-05.10	DBJ	6	<b>0 445 116 022</b>	<b>0 986 435 357</b>
		165/176	CATA <D1T>; CCMA <D50>	11.08→	DBJ	6	<b>0 445 117 002</b>	<b>0 986 435 380</b>
<b>4.2</b> TDI [4LB]	4,2	240	BTR <D1S>	03.07-06.09	DBJ	8	<b>0 445 115 085</b>	<b>0 986 435 364</b>
		250	CCFA <D57>	06.09-05.10	DBJ	8	<b>0 445 117 020</b>	<b>0 986 435 374</b>
<b>6.0</b> TDI [4LB]	6,0	368	CCGA <D56>	09.08→	DBJ	12	<b>0 445 117 011</b>	<b>0 986 435 384</b>
<b>TT Coupé</b>								
<b>2.0</b> TDI quattro [8J3]	2,0	125	CBBB CFGB	06.08-06.10 05.10→	DBJ DBJ	4 4	<b>0 445 116 029</b> <b>0 445 110 368</b>	<b>0 986 435 360</b> <b>0 986 435 166</b>
<b>TT Roadster</b>								
<b>2.0</b> TDI quattro [8J9]	2,0	125	CBBB CFGB	06.08-06.10 05.10→	DBJ DBJ	4 4	<b>0 445 116 029</b> <b>0 445 110 368</b>	<b>0 986 435 360</b> <b>0 986 435 166</b>

BMW

**Serie X**

<b>X1</b> 18 d sDrive, 18 d xDrive [E 84]	2,0	100-105	N47 D20C	11.09→	DBJ	4	<b>0 445 110 289</b>	
20 d ed sDrive [E 84]	2,0	120	N47 D20C	09.11→	DBJ	4	<b>0 445 110 382</b>	
20 d sDrive, 20 d xDrive [E 84]	2,0	120-130	N47 D20C	10.09→	DBJ	4	<b>0 445 116 024</b>	
23 d xDrive [E 84]	2,0	150	N47 D20D	10.09→	DBJ	4	<b>0 445 117 017</b>	
<b>X3</b> 2.0 d [E 83]	2,0	110	20 4D 4 <M 47N>	10.04-09.07	DBJ	4	<b>0 445 110 216</b>	<b>0 986 435 091</b>
2.0 d, 20 d xDrive [E 83]	2,0	120-130	N47 D20...; N47 D20A	09.07-08.10	DBJ	4	<b>0 445 116 001</b>	<b>0 986 435 363</b>
3.0 d [E 83]	3,0	150	30 6D 2 <M 57N>	01.04-09.05	DBJ	6	<b>0 445 110 216</b>	<b>0 986 435 091</b>
		160	30 6D 3 <M 57N2>	09.05-09.07	DBJ	6	<b>0 445 115 070</b>	<b>0 986 435 354</b>
				10.07-08.10	DBJ	6	<b>0 445 115 077</b>	<b>0 986 435 359</b>
3.0 sd [E 83]	3,0	210	30 6D 5	09.06-05.07	DBJ	6	<b>0 445 115 050</b>	<b>0 986 435 359</b>
				06.07-08.08	DBJ	6	<b>0 445 115 077</b>	<b>0 986 435 359</b>
18 d xDrive [E 83]	2,0	105	N47 D20C	05.09-08.10	DBJ	4	<b>0 445 116 024</b>	
20 d xDrive [F 25]	2,0	135	N47 D20C	10.10→	DBJ	4	<b>0 445 110 382</b>	
30 d xDrive [E 83]	3,0	155-160	30 6D 3 <M 57N2>	09.08-08.10	DBJ	6	<b>0 445 115 077</b>	<b>0 986 435 359</b>
30 d xDrive [F 25]	3,0	190	N57 D30A	04.11→	DBJ	6	<b>0 445 110 382</b>	
35 d xDrive [E 83]	3,0	210	30 6D 5	09.08-08.10	DBJ	6	<b>0 445 115 077</b>	<b>0 986 435 359</b>
<b>X5</b> 3.0 d [E 53]	3,0	135	30 6D 1 <M 57 D 30>	03.01-09.03	DBJ	6	<b>0 445 110 266</b>	<b>0 986 435 022</b>
		155-160	30 6D 2 <M 57N>	10.03-10.06	DBJ,EU3	6	<b>0 445 110 131</b>	<b>0 986 435 084</b>
					DBJ,EU4	6	<b>0 445 110 216</b>	<b>0 986 435 091</b>
3.0 d [E 70]	3,0	155-173	30 6D 3 <M 57N2>	03.07-09.07	DBJ	6	<b>0 445 115 070</b>	<b>0 986 435 354</b>
				10.07-09.08	DBJ	6	<b>0 445 115 077</b>	<b>0 986 435 359</b>
3.0 sd, 35 d xDrive [E 70]	3,0	210	30 6D 5	10.07-09.08	DBJ	6	<b>0 445 115 077</b>	<b>0 986 435 359</b>
				10.07-03.10	DBJ	6	<b>0 445 115 077</b>	<b>0 986 435 359</b>
30 d xDrive [E 70]	3,0	173	30 6D 3 <M 57N2>	10.08-03.10	DBJ	6	<b>0 445 115 077</b>	<b>0 986 435 359</b>
		180	N57 D30A	04.10→	DBJ	6	<b>0 445 116 024</b>	
40 d xDrive [E 70]	3,0	225	N57 D30B	04.10→	DBJ	6	<b>0 445 117 017</b>	
<b>X6</b> 30 d xDrive [E 71]	3,0	180	N57 D30A	04.10→	DBJ	6	<b>0 445 116 024</b>	
30 d xDrive, 35 d xDrive [E 71]	3,0	173/210	30 6D 3 <M 57N2>; 30 6D 5	05.08-03.10	DBJ	6	<b>0 445 115 077</b>	<b>0 986 435 359</b>
40 d xDrive [E 71]	3,0	225	N57 D30B	04.10→	DBJ	6	<b>0 445 117 017</b>	

**Serie 1**

<b>116</b> d [E 81]	2,0	85	N47 D20...	03.09→	DBJ	4	<b>0 445 110 289</b>	
d [E 87]	2,0	85	N47 D20...	03.09-06.11	DBJ	4	<b>0 445 110 289</b>	
d [F 20]	2,0	85	N47 D20C	09.11→	DBJ	4	<b>0 445 110 289</b>	
<b>118</b> d [E 81]	2,0	100-105	N47 D20...	05.07→	DBJ	4	<b>0 445 110 289</b>	
d [E 87]	2,0	90	20 4D 4 <M 47N>	09.04-03.07	DBJ	4	<b>0 445 110 209</b>	<b>0 986 435 144</b>
		100-105	N47 D20...	03.07-06.11	DBJ	4	<b>0 445 110 289</b>	
d [F 20]	2,0	105	N47 D20C	09.11→	DBJ	4	<b>0 445 110 289</b>	





◀ BMW

120 d [E 81]	2,0	120-130	N47 D20...	05.07-08.08	DBJ	4	0 445 116 001	0 986 435 363
				09.08→	DBJ,EU3	4	0 445 116 001	0 986 435 363
d [E 87]	2,0	120 120-130	20 4D 4 <M 47N> N47 D20...	09.04-03.07	DBJ	4	0 445 110 216	0 986 435 091
				03.07-08.08	DBJ	4	0 445 116 001	0 986 435 363
				09.08-06.11	DBJ,EU3	4	0 445 116 001	0 986 435 363
d [F 20]	2,0	135	N47 D20C	09.11→	DBJ	4	0 445 110 382	
123 d [E 81]	2,0	150	N47 D20B	09.07→	DBJ	4	0 445 117 017	
d [E 87]	2,0	150	N47 D20...	09.07-06.11	DBJ	4	0 445 117 017	
<b>Serie 1 Cabrio</b>								
118 d [E 88]	2,0	100-105	N47 D20...	09.08→	DBJ	4	0 445 110 289	
120 d [E 88]	2,0	120-130	N47 D20...	03.08-08.08	DBJ	4	0 445 116 001	0 986 435 363
				09.08→	DBJ,EU3	4	0 445 116 001	0 986 435 363
123 d [E 88]	2,0	150	N47 D20B	09.08→	DBJ,EU4	4	0 445 116 024	
				09.08→	DBJ	4	0 445 117 017	
<b>Serie 1 Coupé</b>								
118 d [E 82]	2,0	100-105	N47 D20C	09.09→	DBJ	4	0 445 110 289	
120 d [E 82]	2,0	120-130	N47 D20...	10.07-08.08	DBJ	4	0 445 116 001	0 986 435 363
				09.08→	DBJ,EU3	4	0 445 116 001	0 986 435 363
123 d [E 82]	2,0	150	N47 D20B	09.08→	DBJ,EU4	4	0 445 116 024	
				10.07→	DBJ	4	0 445 117 017	
<b>Serie 3</b>								
316 d [E 90]	2,0	85	N47 D20C	09.09→	DBJ	4	0 445 110 289	
d [F 30]	2,0	85	N47 D20C	03.12→	DBJ	4	0 445 110 289	
318 d [E 46]	2,0	85	20 4D 4 <M 47N>	03.03-03.05	DBJ	4	0 445 110 149	0 986 435 157
				09.05-09.07	DBJ	4	0 445 110 209	0 986 435 144
d [E 90]	2,0	90 100-105	20 4D 4 <M 47N> N47 D20...	09.07→	DBJ	4	0 445 110 289	
				03.12→	DBJ	4	0 445 110 289	
320 d [E 46]	2,0	110	20 4D 4 <M 47N>	09.01-03.05	DBJ,EU3	4	0 445 110 131	0 986 435 084
					DBJ,EU4	4	0 445 110 216	0 986 435 091
d [E 90]	2,0	110/120 130	20 4D 4 <M 47N> N47 D20...	03.05-09.07	DBJ	4	0 445 110 216	0 986 435 091
				09.07-08.08	DBJ	4	0 445 116 001	0 986 435 363
				09.08-03.10	DBJ,EU3	4	0 445 116 001	0 986 435 363
d, d ed [F 30]	2,0	120/135	N47 D20C	02.12→	DBJ	4	0 445 110 382	
				03.10→	DBJ	4	0 445 110 382	
d, d ed, d xDrive [E 90]	2,0	120-135	N47 D20C <N47N>	09.08-02.10	DBJ	4	0 445 116 024	
d xDrive [E 90]	2,0	130	N47 D20C	09.08-02.10	DBJ	4	0 445 116 024	
325 d [E 90]	3,0	145 150	30 6D 3 <M 57N2> N57 D30A	09.06-02.10	DBJ	6	0 445 110 209	0 986 435 144
				03.10→	DBJ	6	0 445 116 024	
330 d [E 46]	3,0	150	30 6D 2 <M 57N>	03.03-03.05	DBJ,EU3	6	0 445 110 131	0 986 435 084
					DBJ,EU4	6	0 445 110 216	0 986 435 091
d, d xDrive [E 90]	3,0	180	N57 D30A	09.08→	DBJ	6	0 445 116 024	
d, xd [E 46]	3,0	135	30 6D 1 <M 57 D 30>	10.99-04.03	DBJ	6	0 445 110 266	0 986 435 022
d, xd [E 90]	3,0	170	30 6D 3 <M 57N2>	09.05-09.07	DBJ	6	0 445 115 070	0 986 435 354
				10.07-08.08	DBJ	6	0 445 115 077	0 986 435 359
xd [E 46]	3,0	150	30 6D 2 <M 57N>	03.03-03.05	DBJ	6	0 445 110 131	0 986 435 084
335 d [E 90]	3,0	210	30 6D 5 <M 57..>	09.06-05.07	DBJ	6	0 445 115 050	0 986 435 359
				06.07→	DBJ	6	0 445 115 077	0 986 435 359
<b>Serie 3 Cabrio</b>								
320 d [E 46]	2,0	110	20 4D 4 <M 47N>	01.05-08.06	DBJ,EU3	4	0 445 110 131	0 986 435 084
					DBJ,EU4	4	0 445 110 216	0 986 435 091
d [E 93]	2,0	120-135 130	N47 D20C <N47N> N47 D20...	03.10→	DBJ	4	0 445 110 382	
				03.08-08.08	DBJ	4	0 445 116 001	0 986 435 363
				09.08-02.10	DBJ,EU3	4	0 445 116 001	0 986 435 363
325 d [E 93]	3,0	145 150	30 6D 3 <M 57N2> N57 D30A	09.07-02.10	DBJ	6	0 445 110 209	0 986 435 144
				03.10→	DBJ	6	0 445 116 024	
330 d [E 46]	3,0	150	30 6D 2 <M 57N>	04.05-08.06	DBJ,EU3	6	0 445 110 131	0 986 435 084
					DBJ,EU4	6	0 445 110 216	0 986 435 091
d [E 93]	3,0	170	30 6D 3 <M 57N2>	03.07-09.07	DBJ	6	0 445 115 070	0 986 435 354
				10.07-02.09	DBJ	6	0 445 115 077	0 986 435 359
				03.09→	DBJ	6	0 445 116 024	





Serie 3 Compact									
318 td [E 46]	2,0	85	20 4D 4 <M 47N>	03.03-12.04	DBJ	4	0 445 110 149	0 986 435 157	
320 td [E 46]	2,0	110	20 4D 4 <M 47N>	09.01-12.04	DBJ,EU3	4	0 445 110 131	0 986 435 084	
					DBJ,EU4	4	0 445 110 216	0 986 435 091	
Serie 3 Coupé									
320 d [E 46]	2,0	110	20 4D 4 <M 47N>	09.03-05.06	DBJ,EU3	4	0 445 110 131	0 986 435 084	
					DBJ,EU4	4	0 445 110 216	0 986 435 091	
d [E 92]	2,0	130	N47 D20...	03.07-08.08	DBJ	4	0 445 116 001	0 986 435 363	
				09.08-02.10	DBJ,EU3	4	0 445 116 001	0 986 435 363	
					DBJ,EU4	4	0 445 116 024		
d, d xDrive [E 92]	2,0	120-135	N47 D20C <N47N>	03.10→	DBJ	4	0 445 110 382		
d xDrive [E 92]	2,0	130	N47 D20C	09.08-02.10	DBJ	4	0 445 116 024		
325 d [E 92]	3,0	145	30 6D 3 <M 57N2>	03.07-02.10	DBJ	6	0 445 110 209	0 986 435 144	
		150	N57 D30A	03.10→	DBJ	6	0 445 116 024		
330 d [E 46]	3,0	150	30 6D 2 <M 57N>	03.03-05.06	DBJ,EU3	6	0 445 110 131	0 986 435 084	
					DBJ,EU4	6	0 445 110 216	0 986 435 091	
d, d xDrive [E 92]	3,0	180	N57 D30A	09.08→	DBJ	6	0 445 116 024		
d, xd [E 92]	3,0	170	30 6D 3 <M 57N2>	09.06-09.07	DBJ	6	0 445 115 070	0 986 435 354	
				10.07-08.08	DBJ	6	0 445 115 077	0 986 435 359	
335 d [E 92]	3,0	210	30 6D 5	09.06-05.07	DBJ	6	0 445 115 050	0 986 435 359	
				06.07→	DBJ	6	0 445 115 077	0 986 435 359	
Serie 3 Touring									
316 d [E 91]	2,0	85	N47 D20C <N47N>	03.10→	DBJ	4	0 445 110 289		
318 d [E 46]	2,0	85	20 4D 4 <M 47N>	03.03-09.05	DBJ	4	0 445 110 149	0 986 435 157	
d [E 91]	2,0	90	20 4D 4 <M 47N>	03.06-09.07	DBJ	4	0 445 110 209	0 986 435 144	
		100-105	N47 D20...	09.07→	DBJ	4	0 445 110 289		
320 d [E 46]	2,0	110	20 4D 4 <M 47N>	09.01-09.05	DBJ,EU3	4	0 445 110 131	0 986 435 084	
					DBJ,EU4	4	0 445 110 216	0 986 435 091	
d [E 91]	2,0	110/120	20 4D 4 <M 47N>	09.05-09.07	DBJ	4	0 445 110 216	0 986 435 091	
		130	N47 D20...	09.07-08.08	DBJ	4	0 445 116 001	0 986 435 363	
				09.08-02.10	DBJ,EU3	4	0 445 116 001	0 986 435 363	
					DBJ,EU4	4	0 445 116 024		
d, d ed, d xDrive [E 91]	2,0	120-135	N47 D20C <N47N>	03.10→	DBJ	4	0 445 110 382		
d xDrive [E 91]	2,0	130	N47 D20C	09.08-02.10	DBJ	4	0 445 116 024		
325 d [E 91]	3,0	145	30 6D 3 <M 57N2>	09.06-02.10	DBJ	6	0 445 110 209	0 986 435 144	
		150	N57 D30A	03.10→	DBJ	6	0 445 116 024		
330 d [E 46]	3,0	150	30 6D 2 <M 57N>	03.03-09.05	DBJ,EU3	6	0 445 110 131	0 986 435 084	
					DBJ,EU4	6	0 445 110 216	0 986 435 091	
d, d xDrive [E 91]	3,0	180	N57 D30A	09.08→	DBJ	6	0 445 116 024		
d, xd [E 46]	3,0	135	30 6D 1 <M 57 D 30>	10.99-03.03	DBJ	6	0 445 110 266	0 986 435 022	
d, xd [E 91]	3,0	170	30 6D 3 <M 57N2>	09.05-09.07	DBJ	6	0 445 115 070	0 986 435 354	
				10.07-08.08	DBJ	6	0 445 115 077	0 986 435 359	
xd [E 46]	3,0	150	30 6D 2 <M 57N>	03.03-09.05	DBJ	6	0 445 110 131	0 986 435 084	
335 d [E 91]	3,0	210	30 6D 5	09.06-05.07	DBJ	6	0 445 115 050	0 986 435 359	
				06.07→	DBJ	6	0 445 115 077	0 986 435 359	
Serie 5									
520 d [E 60]	2,0	110/120	20 4D 4 <M 47N>	09.05-02.08	DBJ	4	0 445 110 216	0 986 435 091	
		130	N47 D20...	09.07-08.08	DBJ	4	0 445 116 001	0 986 435 363	
				09.08-02.10	DBJ,EU3	4	0 445 116 001	0 986 435 363	
					DBJ,EU4	4	0 445 116 024		
d [F 10]	2,0	135	N47 D20C <N47N>	05.10→	DBJ	4	0 445 110 382		
525 d [E 39]	2,5	120	25 6D 1	04.00-07.03	DBJ	6	0 445 110 048	0 986 435 094	
d [E 60]	2,5	120/130	25 6D 2	05.04-03.07	DBJ	6	0 445 110 212	0 986 435 151	
d [F 10]	3,0	150	N57 D30A	03.10→	DBJ	6	0 445 116 024		
d, d xDrive, xd [E 60]	3,0	145	30 6D 3 <M 57N2>	03.07-02.10	DBJ	6	0 445 110 209	0 986 435 144	
530 d [E 39]	3,0	135-142	30 6D 1 <M 57 D 30>	08.98-09.99	DBJ,GS	6	0 445 110 029	0 986 435 010	
				08.98-03.00	AG,DBJ	6	0 445 110 029	0 986 435 010	
				10.99-07.03	DBJ,GS	6	0 445 110 266	0 986 435 022	
				04.00-07.03	AG,DBJ	6	0 445 110 266	0 986 435 022	
d [E 60]	3,0	160	30 6D 2 <M 57N>	07.03-09.05	DBJ,EU3	6	0 445 110 131	0 986 435 084	
					DBJ,EU4	6	0 445 110 216	0 986 435 091	
d [F 10]	3,0	180	N57 D30A	03.10→	DBJ	6	0 445 116 024		
d, d xDrive, xd [E 60]	3,0	173	30 6D 3 <M 57N2>	03.07-02.10	DBJ	6	0 445 115 050	0 986 435 359	





◀ BMW

530 d, xd [E 60]	3,0	170	30 6D 3 <M 57N2>	09.05-03.07	DBJ	6	0 445 115 070	0 986 435 354
d xDrive [F 10]	3,0	190	N57 D30A	03.11→	DBJ	6	0 445 110 382	
535 d [E 60]	3,0	200	30 6D 4	09.04-03.07	DBJ	6	0 445 110 219	0 986 435 092
		210	30 6D 5	03.07-02.10	DBJ	6	0 445 115 050	0 986 435 359
d [F 10]	3,0	220	N57 D30B <N57S>	09.10→	DBJ	6	0 445 117 017	
<b>Serie 5 GT</b>								
530 d, d xDrive [F 07]	3,0	155/180	N57 D30A	10.09→	DBJ	6	0 445 116 024	
535 d, d xDrive [F 07]	3,0	220	N57 D30B	03.10→	DBJ	6	0 445 117 017	
<b>Serie 5 Touring</b>								
520 d [E 61]	2,0	110/120	20 4D 4 <M 47N>	09.05-02.08	DBJ	4	0 445 110 216	0 986 435 091
		130	N47 D20...	09.07-08.08	DBJ	4	0 445 116 001	0 986 435 363
				09.08-08.10	DBJ,EU3	4	0 445 116 001	0 986 435 363
					DBJ,EU4	4	0 445 116 024	
d [F 11]	2,0	135	N47 D20C <N47N>	09.10→	DBJ	4	0 445 110 382	
525 d [E 39]	2,5	120	25 6D 1	04.00-05.04	DBJ	6	0 445 110 048	0 986 435 094
d [E 61]	2,5	120/130	25 6D 2	05.04-03.07	DBJ	6	0 445 110 212	0 986 435 151
d [F 11]	3,0	150	N57 D30A	09.10→	DBJ	6	0 445 116 024	
d, d xDrive, xd [E 61]	3,0	145	30 6D 3 <M 57N2>	03.07-08.10	DBJ	6	0 445 110 209	0 986 435 144
530 d [E 39]	3,0	135-142	30 6D 1 <M 57 D 30>	08.98-09.99	DBJ,GS	6	0 445 110 029	0 986 435 010
				08.98-03.00	AG,DBJ	6	0 445 110 029	0 986 435 010
				10.99-05.04	DBJ,GS	6	0 445 110 266	0 986 435 022
				04.00-05.04	AG,DBJ	6	0 445 110 266	0 986 435 022
d [E 61]	3,0	160	30 6D 2 <M 57N>	05.04-09.05	DBJ,EU3	6	0 445 110 131	0 986 435 084
					DBJ,EU4	6	0 445 110 216	0 986 435 091
d [F 11]	3,0	180	N57 D30A	09.10→	DBJ	6	0 445 116 024	
d, d xDrive, xd [E 61]	3,0	173	30 6D 3 <M 57N2>	03.07-08.10	DBJ	6	0 445 115 050	0 986 435 359
d, xd [E 61]	3,0	170	30 6D 3 <M 57N2>	09.05-03.07	DBJ	6	0 445 115 070	0 986 435 354
d xDrive [F 11]	3,0	190	N57 D30A	03.11→	DBJ	6	0 445 110 382	
535 d [E 61]	3,0	200	30 6D 4	09.04-03.07	DBJ	6	0 445 110 219	0 986 435 092
		210	30 6D 5	03.07-08.10	DBJ	6	0 445 115 050	0 986 435 359
d [F 11]	3,0	220	N57 D30B <N57S>	09.10→	DBJ	6	0 445 117 017	
<b>Serie 6</b>								
635 d [E 63]	3,0	210	30 6D 5	09.07-07.10	DBJ	6	0 445 115 050	0 986 435 359
<b>Serie 6 Cabrio</b>								
635 d [E 64]	3,0	210	30 6D 5	09.07-07.10	DBJ	6	0 445 115 050	0 986 435 359
<b>Serie 7</b>								
730 d [E 38]	3,0	135-142	30 6D 1 <M 57 D 30>	08.98-03.00	DBJ	6	0 445 110 029	0 986 435 010
				04.00-12.01	DBJ	6	0 445 110 266	0 986 435 022
d [E 65]	3,0	160	30 6D 2 <M 57N>	10.02-03.05	DBJ	6	0 445 110 131	0 986 435 084
		170	30 6D 3 <M 57N2>	04.05-10.08	DBJ	6	0 445 115 070	0 986 435 354
d [F 01]	3,0	180	N57 D30A	11.08→	DBJ	6	0 445 116 024	
Ld [E 66]	3,0	170	30 6D 3 <M 57N2>	09.05-10.08	DBJ	6	0 445 115 070	0 986 435 354
Ld [F 02]	3,0	180	N57 D30A	03.09→	DBJ	6	0 445 116 024	
740 d [E 38]	3,9	180	39 8D 1 <M 67>	10.98-12.01	DBJ	8	0 445 110 028	0 986 435 009
d [E 65]	3,9	190	39 8D 1	10.02-03.05	DBJ	8	0 445 110 122	
d, d xDrive [F 01]	3,0	225	N57 D30B	09.09→	DBJ	6	0 445 117 017	
745 d [E 65]	4,4	220/242	44 8D 1	03.05-10.08	DBJ	8	0 445 115 009	



**CHEVROLET**

**Aveo**

1.3 D [KL1T, T300]	1,2	55		09.11→	DBJ,EU5	4	0 445 110 326	
		70		09.11→	DBJ	4	0 445 110 326	

**Aveo Hatchback**

1.3 D [KL1T, T300]	1,2	55		09.11→	DBJ,EU5	4	0 445 110 326	
		70		09.11→	DBJ	4	0 445 110 326	

**Blazer**

2.8 D Electronic	2,8	103	4.07 TCE <Sprint Euro 3>	08.05-05.09	DBB	4	0 445 110 231	
------------------	-----	-----	--------------------------	-------------	-----	---	---------------	--

**Captiva**

2.0 CDRI, CDRI 4x4 [KL1C,C100]	2,0	93/110	Z20S	10.06-02.11	DBJ	4	0 445 110 269	0 986 435 153
--------------------------------	-----	--------	------	-------------	-----	---	---------------	---------------

**Cruze**

2.0 CDI [KL1J,J300]	2,0	110	Z20S1	05.09→	DBJ	4	0 445 110 269	0 986 435 153
---------------------	-----	-----	-------	--------	-----	---	---------------	---------------



<b>Epica</b>									
2.0	CDi [KL1L,V250]	2,0	110	Z20S	09.06→	DBJ	4	0 445 110 269	0 986 435 153
<b>Express 2500</b>									
6.6		6,6	187	LLY	09.05-08.06	DBJ	8	0 445 120 042	0 986 435 521
					09.06-08.07	DBJ	8	0 445 120 082	
<b>Express 3500</b>									
6.6		6,6	187	LLY	09.05-08.06	DBJ	8	0 445 120 042	0 986 435 521
					09.06-08.07	DBJ	8	0 445 120 082	
<b>Lacetti</b>									
2.0	D [KL1N, J200]	2,0	89	Z20S	09.06→	DBJ	4	0 445 110 269	0 986 435 153
<b>Nubira</b>									
2.0	D [KL1N, J200]	2,0	89	Z20S	09.06→	DBJ	4	0 445 110 269	0 986 435 153
<b>Nubira Wagon</b>									
2.0	D [KL1N, J200]	2,0	89	Z20S	09.06→	DBJ	4	0 445 110 269	0 986 435 153
<b>Silverado 3500</b>									
6.6		6,6	224-231	LB7	09.00-08.04	DBJ	8	0 445 120 008	
				LLY	09.04-08.05	DBJ	8	0 445 120 027	0 986 435 504
					09.05-08.06	DBJ	8	0 445 120 042	0 986 435 521
4x4		6,6	269	LBZ	09.05-08.06	DBJ	8	0 445 120 042	0 986 435 521
					09.06-08.07	DBJ	8	0 445 120 082	

**CHRYSLER**

<b>Voyager</b>									
2.5	CRD, CRD 4x4 [RG]	2,5	105	ENC; ENJ	09.00-08.07	DBJ	4	0 445 110 059	0 986 435 149
2.8	CRD, CRD 4x4 [RG]	2,8	110	ENR	08.04-12.07	DBJ	4	0 445 110 059	0 986 435 149

**CITROEN**

<b>Berlingo</b>									
1.6	Hdi [B9]	1,6	55/66	9HT <DV6B/DV6BUTED4>; 9HX <DV6ATED4/DV6AUTED4>	05.08→	DBJ	4	0 445 110 311	0 986 435 146
			55/66/68	9HF <DV6DTED>; 9HJ <DV6DTED M>; 9HK <DV6ETED M>; 9HN <DV6ETED4>; 9HP <DV6DTED>	07.10→	DBJ	4	0 445 110 340	
			66	9HS <DV6TED4BU/FAP>; 9HV <DV6TED4/FAP>	10.08→	DBJ	4	0 445 110 297	0 986 435 150
			80	9HZ <DV6TED4>	05.08→	DBJ	4	0 445 110 297	0 986 435 150
	Hdi [M59]	1,6	55/66	9HW <DV6B>; 9HX <DV6ATED4>	09.05-04.08	DBJ	4	0 445 110 239	0 986 435 122
2.0	Hdi [M49]	2,0	66	RHY <DW10TD>					
				Org.Nr. →8728	12.99-10.00	DBB,I2G	4	0 445 110 044	0 986 435 003
						DBJ,I1B	4	0 445 110 008	0 986 435 003
				Org.Nr. 8729→	11.00-11.02	DBJ,I1B, I2G	4	0 445 110 062	0 986 435 077
	HDI	2,0	66	DW10TD	10.00→	DBB	4	0 445 110 044	0 986 435 003
<b>C-Crosser</b>									
2.2	Hdi 4x4 [I4]	2,2	115	4HK <DW12ME5>; 4HN <DW12METED4/FAP>	09.07→	DBB	4	0 445 115 025	0 986 435 351
<b>C2</b>									
1.4	Hdi [A6]	1,4	50	8H... <DV4TD>	09.03-12.09	BO,DBB, N14	4	0 445 110 135	0 986 435 085
						BO,DBJ, FL5	4	0 445 110 252	0 986 435 143
1.6	Hdi [A6]	1,6	80	9HZ <DV6TED4>	07.07-05.09	DBJ	4	0 445 110 297	0 986 435 150
<b>C3</b>									
1.4	Hdi	1,4	52	8HW <DV4TD>	07.03→	BO,DBB, N14	4	0 445 110 135	0 986 435 085
	Hdi [A31]	1,4	50	8HZ <DV4TD>	09.05-09.09	BO,DBB, N14	4	0 445 110 135	0 986 435 085
						BO,DBJ, FL5	4	0 445 110 252	0 986 435 143















◀ CITROEN

1.4 HDi [A51]	1,4	50	8H... <DV4C>	06.10→	DBJ	4	0 445 110 339				
			8HZ <DV4TD>	09.09→	DBJ	4	0 445 110 252	0 986 435 143			
1.6 HDi [A31]	1,6	66	9HX <DV6ATED4>								
			Org.Nr. →11143	09.05-05.07	DBJ	4	0 445 110 239	0 986 435 122			
			Org.Nr. 11144→	06.07-12.09	DBJ	4	0 445 110 311	0 986 435 146			
			80	9HZ <DV6TED4>							
			Org.Nr. →11143	09.05-05.07	DBJ	4	0 445 110 259	0 986 435 126			
			Org.Nr. 11144→	06.07-05.09	DBJ	4	0 445 110 297	0 986 435 150			
HDi [A51]	1,6	66	9HX <DV6ATED4>	09.09→	DBJ	4	0 445 110 311	0 986 435 146			
			68	9HP <DV6DTED>	01.10→	DBJ	4	0 445 110 340			
<b>C3 Picasso</b>											
1.6 HDi [A58]	1,6	66	9HX <DV6ATED4>	02.09→	DBJ	4	0 445 110 311	0 986 435 146			
			68	9HP <DV6DTED>	03.10→	DBJ	4	0 445 110 340			
			80	9HZ <DV6TED4>	02.09→	DBJ	4	0 445 110 297	0 986 435 150		
<b>C3-Pluriel</b>											
1.4 HDi [A42]	1,4	50	8H... <DV4TD>	10.03-01.10	BO,DBJ	4	0 445 110 252	0 986 435 143			
<b>C4</b>											
1.6 HDi [B5]	1,6	66	9HV <DV6TED4/FAP>	05.07-07.09	DBJ	4	0 445 110 297	0 986 435 150			
			9HX <DV6ATED4>	11.04-07.05	DBJ	4	0 445 110 239	0 986 435 122			
			80	9H... <DV6TED4>							
			Org.Nr. →10373	11.04-04.05	DBJ	4	0 445 110 188	0 986 435 090			
			Org.Nr. 10374→11059	05.05-02.07	DBJ	4	0 445 110 259	0 986 435 126			
			Org.Nr. 11060→	03.07→	DBJ	4	0 445 110 297	0 986 435 150			
HDi [B71]	1,6	68	9HJ <DV6DTED M>; 9HP <DV6DTED>	09.10→	DBJ	4	0 445 110 340				
<b>C4 Coupé</b>											
1.6 HDi [B5]	1,6	66	9HV <DV6TED4/FAP>	05.07-07.09	DBJ	4	0 445 110 297	0 986 435 150			
			9HX <DV6ATED4>	11.04-07.05	DBJ	4	0 445 110 239	0 986 435 122			
			80	9H... <DV6TED4>							
			Org.Nr. →10373	11.04-04.05	DBJ	4	0 445 110 188	0 986 435 090			
			Org.Nr. 10374→11059	05.05-02.07	DBJ	4	0 445 110 259	0 986 435 126			
			Org.Nr. 11060→	03.07→	DBJ	4	0 445 110 297	0 986 435 150			
<b>C4 Grand Picasso</b>											
1.6 HDi [B58]	1,6	80	9H... <DV6TED4>	10.06→	DBJ,MPR	4	0 445 110 259	0 986 435 126			
			Org.Nr. →11438	10.06-03.08	DBJ,MPR	4	0 445 110 259	0 986 435 126			
			Org.Nr. 11439→	04.08→	DBJ,MPR	4	0 445 110 297	0 986 435 150			
<b>C4 Picasso</b>											
1.6 HDi [B58]	1,6	80	9H... <DV6TED4>	02.07→	DBJ,MPR	4	0 445 110 259	0 986 435 126			
			Org.Nr. →11438	02.07-03.08	DBJ,MPR	4	0 445 110 259	0 986 435 126			
			Org.Nr. 11439→	04.08→	DBJ,MPR	4	0 445 110 297	0 986 435 150			
<b>C5</b>											
1.6 HDi [X3]	1,6	80	9H... <DV6TED4>	10.04-03.08	DBJ,MPR	4	0 445 110 259	0 986 435 126			
			Org.Nr. →10373	10.04-04.05	DBJ,MPR	4	0 445 110 188	0 986 435 090			
			Org.Nr. 10374→	05.05-03.08	DBJ,MPR	4	0 445 110 259	0 986 435 126			
HDi [X7]	1,6	80	9HZ <DV6TED4>	04.08-07.10	DBJ	4	0 445 110 297	0 986 435 150			
2.0 HDi [X4]	2,0	66	RHY <DW10TD>	03.01-09.04	BO,DBB	4	0 445 110 076	0 986 435 077			
			79	RHS <DW10ATED/FAP>	03.01-09.04	DBB	4	0 445 110 076	0 986 435 077		
			80	RHZ <DW10ATED>	04.01-09.04	DBB	4	0 445 110 076	0 986 435 077		
			Org.Nr. →8903	03.01-03.01	DBJ,GS, I1B,I2G	4	0 445 110 062	0 986 435 077			
2.2 HDi [X3]	2,2	98	4HX <DW12TED4>	10.04-09.05	DBB	4	0 445 110 036	0 986 435 013 0 986 435 014 0 986 435 015			
			125	4H... <DW12BTED4>	03.06-03.08	DBB	4	0 445 115 025	0 986 435 351		
			HDi [X4]	2,2	98	4HX <DW12TED4>	03.01-09.04	DBB,I1B	4	0 445 110 036	0 986 435 013 0 986 435 014 0 986 435 015
								I3K	4	0 986 436 015	
			HDi [X7]	2,2	125	4H... <DW12BTED4>	04.08-09.09	DBB	4	0 445 115 025	0 986 435 351
		150	4HL <DW12C>	07.10→	DBJ	4	0 445 115 087				
<b>C5 Break</b>											
1.6 HDi [X3]	1,6	80	9H... <DV6TED4>	10.04-03.08	DBJ,MPR	4	0 445 110 259	0 986 435 126			
			Org.Nr. →10373	10.04-04.05	DBJ,MPR	4	0 445 110 188	0 986 435 090			
			Org.Nr. 10374→	05.05-03.08	DBJ,MPR	4	0 445 110 259	0 986 435 126			



										
		l/ccm	kW/(PS)	Typ				Zyl.		
2.0 HDi [X4]	2,0	66	RHY <DW10TD>	06.01-09.04	BO,DBB	4	0 445 110 076	0 986 435 077		
			79/80	RHS <DW10ATED/FAP>; RHZ <DW10ATED>	06.01-09.04	DBB	4	0 445 110 076	0 986 435 077	
2.2 HDi [X3]	2,2	98	4HX <DW12TED4>	10.04-09.05	DBB	4	0 445 110 036	0 986 435 013 0 986 435 014 0 986 435 015		
			125	4H... <DW12BTED4>	04.06-03.08	DBB	4	0 445 115 025	0 986 435 351	
HDi [X4]	2,2	98	4HX <DW12TED4>	06.01-09.04	DBB,11B	4	0 445 110 036	0 986 435 013 0 986 435 014 0 986 435 015		
<b>C5 Tourer</b>										
1.6 HDi [X7]	1,6	80	9HZ <DV6TED4>	04.08-07.10	DBJ	4	0 445 110 297	0 986 435 150		
2.2 HDi [X7]	2,2	125	4H... <DW12BTED4>	04.08-09.09	DBB	4	0 445 115 025	0 986 435 351		
		150	4HL <DW12C>	07.10→	<del>DBJ</del>	4	0 445 115 087			
<b>C6</b>										
2.2 HDi [X6]	2,2	125	4H... <DW12BTED4>	06.06-07.10	DBB	4	0 445 115 025	0 986 435 351		
<b>C8</b>										
2.0 HDi [V3]	2,0	81	RH... <DW10ATED4/FAP>; RHW <DW10ATED4>	06.02-12.06	DBB	4	0 445 110 057	0 986 435 093		
2.2 HDi [V3]	2,2	94	4HW <DW12TED4/FAP>	06.02-07.06	DBB	4	0 445 110 036	0 986 435 013 0 986 435 014 0 986 435 015		
			125	4H... <DW12BTED4>	09.07-05.10	DBB	4	0 445 115 025	0 986 435 351	
<b>DS3</b>										
1.4 HDi 8V [A55]	1,4	50	8H... <DV4C>	03.10→	DBJ	4	0 445 110 339			
1.6 HDi [A55]	1,6	68	9HP <DV6DTE>	01.10→	DBJ	4	0 445 110 340			
<b>DS4</b>										
1.6 HDi 16V [B75]	1,6	68	9HP <DV6DTE>	03.11→	DBJ	4	0 445 110 340			
<b>Evasion</b>										
2.0 HDi [U60]	2,0	80	RHZ <DW10ATED/L3>	01.99-07.02	DBB,12G	4	0 445 110 044	0 986 435 003		
			81	RHW <DW10ATED4/L4>	06.00-07.02	DBB,11B	4	0 445 110 008	0 986 435 003	
<b>Jumpy</b>										
1.6 HDi [G9]	1,6	66	9HM <DV6UC>	12.10→	DBJ	4	0 445 110 340			
			9HU <DV6UTED4>	02.07→	DBJ	4	0 445 110 239	0 986 435 122		
2.0 HDi [U64]	2,0	70	RHX <DW10BTED>	10.99-11.00	DBB	4	0 445 110 044	0 986 435 003		
			Org.Nr. →8763	12.00-01.07	DBB	4	0 445 110 076	0 986 435 077		
			Org.Nr. 8764→	10.99-01.07	DBB,12G	4	0 445 110 044	0 986 435 003		
			80	RHZ <DW10ATED>	06.00-01.07	DBB,11B	4	0 445 110 008	0 986 435 003	
		81	RHW <DW10ATED4>	06.00-01.07	DBB	4	0 445 110 057	0 986 435 093		
<b>Nemo</b>										
1.4 HDi [A9]	1,4	50	8HS <DV4TED>	02.08→	DBJ	4	0 445 110 252	0 986 435 143		
<b>Xantia</b>										
2.0 HDi [X2]	2,0	66	RHY <DW10TD>	03.99-12.01	DBB,12G	4	0 445 110 044	0 986 435 003		
			81	RHZ <DW10ATED>	10.98-12.01	DBB,11B	4	0 445 110 008	0 986 435 003	
<b>Xantia Break</b>										
2.0 HDi [X2]	2,0	66	RHY <DW10TD>	03.99-12.01	DBB,12G	4	0 445 110 044	0 986 435 003		
			81	RHZ <DW10ATED>	10.98-12.01	DBB,11B	4	0 445 110 008	0 986 435 003	
<b>Xsara</b>										
1.4 HDi [N7]	1,4	50	8HZ <DV4TD>	01.03-12.05	DBB	4	0 445 110 135	0 986 435 085		
2.0 HDi [N6]	2,0	66	RHY <DW10TD>	02.99-05.00	DBB	4	0 445 110 044	0 986 435 003		
			Org.Nr. →8574	06.00-08.00	DBB	4	0 445 110 076	0 986 435 077		
			Org.Nr. 8575→	09.00-12.05	BO,DBB	4	0 445 110 076	0 986 435 077		
HDi [N7]	2,0	66	RHY <DW10TD>	09.00-12.05	BO,DBB	4	0 445 110 076	0 986 435 077		
		80	RHZ <DW10ATED>	09.00-12.05	DBB	4	0 445 110 076	0 986 435 077		
<b>Xsara Break</b>										
1.4 HDi [N7]	1,4	50	8HZ <DV4TD>	01.03-12.05	DBB	4	0 445 110 135	0 986 435 085		





◀ CITROEN

<b>2.0 HDi [N6]</b>	2,0	66	RHY <DW10TD>						
			Org.Nr. →8574	02.99-05.00	DBB	4	<b>0 445 110 044</b>	<b>0 986 435 003</b>	
			Org.Nr. 8575→	06.00-08.00	DBB	4	<b>0 445 110 076</b>	<b>0 986 435 077</b>	
HDi [N7]	2,0	66	RHY <DW10TD>	09.00-03.10	BO,DBB	4	<b>0 445 110 076</b>	<b>0 986 435 077</b>	
		80	RHZ <DW10ATED>	09.00-03.10	DBB	4	<b>0 445 110 076</b>	<b>0 986 435 077</b>	
<b>Xsara Coupé</b>									
<b>2.0 HDi [N6]</b>	2,0	66	RHY <DW10TD>						
			Org.Nr. →8574	02.99-05.00	DBB	4	<b>0 445 110 044</b>	<b>0 986 435 003</b>	
			Org.Nr. 8575→	06.00-08.00	DBB	4	<b>0 445 110 076</b>	<b>0 986 435 077</b>	
HDi [N7]	2,0	66	RHY <DW10TD>	09.00-12.05	BO,DBB	4	<b>0 445 110 076</b>	<b>0 986 435 077</b>	
		80	RHZ <DW10ATED>	09.00-12.05	DBB	4	<b>0 445 110 076</b>	<b>0 986 435 077</b>	
<b>Xsara Picasso</b>									
<b>1.6 HDi [N68]</b>	1,6	66	9HX <DV6ATED4>	09.05-04.10	DBJ	4	<b>0 445 110 239</b>	<b>0 986 435 122</b>	
		80	9H... <DV6TED4>						
			Org.Nr. →10338	05.04-03.05	DBJ	4	<b>0 445 110 188</b>	<b>0 986 435 090</b>	
			Org.Nr. 10339→	04.05-04.10	DBJ	4	<b>0 445 110 259</b>	<b>0 986 435 126</b>	
<b>2.0 HDi [N68]</b>	2,0	66	RHY <DW10TD>	01.00-04.10	DBB,I2G	4	<b>0 445 110 044</b>	<b>0 986 435 003</b>	
					DBB,KKX, KKY,KKZ	4	<b>0 445 110 076</b>	<b>0 986 435 077</b>	
					DBB,I1B	4	<b>0 445 110 008</b>	<b>0 986 435 003</b>	

**DODGE**

<b>Ram 2500 Pickup</b>									
<b>5.9</b>	5,9	160-175	ETC						
				09.02-08.04	DBJ	6	<b>0 445 120 113</b>	<b>0 986 435 503</b>	
				09.03-08.04	DBJ	6	<b>0 986 435 505</b>	<b>0 986 435 505</b>	
, 4x4	5,9	242	ETH						
				09.02-08.04	DBJ	6	<b>0 445 120 113</b>	<b>0 986 435 503</b>	
				09.03-08.06	DBJ	6	<b>0 986 435 505</b>	<b>0 986 435 505</b>	
<b>Ram 3500 Pickup</b>									
<b>5.9</b>	5,9	242	ETH						
				09.03-08.04	DBJ	6	<b>0 445 120 113</b>	<b>0 986 435 503</b>	
				09.03-08.06	DBJ	6	<b>0 986 435 505</b>	<b>0 986 435 505</b>	
, 4x4	5,9	160-175	ETC						
				09.02-08.04	DBJ	6	<b>0 445 120 113</b>	<b>0 986 435 503</b>	
				09.03-08.04	DBJ	6	<b>0 986 435 505</b>	<b>0 986 435 505</b>	
4x4	5,9	242	ETH						
				09.03-12.03	DBJ	6	<b>0 445 120 113</b>	<b>0 986 435 503</b>	
				01.04-08.06	DBJ	6	<b>0 986 435 505</b>	<b>0 986 435 505</b>	

**FIAT**

<b>Albea</b>									
<b>1.3 JTD 16V [172..]</b>	1,3	52	188 A 9.000 <M40>	07.03→	DBB	4	<b>0 445 110 083</b>	<b>0 986 435 078</b>	
<b>Brava</b>									
<b>1.9 JTD [182..]</b>	1,9	76	182 B 4.000 <M25>	11.98-09.01	DBB	4	<b>0 445 110 002</b>	<b>0 986 435 001</b>	
			182 B 9.000 <M26>	08.00-09.01	DBB	4	<b>0 445 110 068</b>	<b>0 986 435 083</b>	
<b>Bravo</b>									
<b>1.6 JTD [198]</b>	1,6	66/77/88	198 A 2.000; 198 A 3.000; 198 A 6.000	03.10→	DBJ	4	<b>0 445 110 300</b>		
JTD 8V, JTD 16V [198]	1,6	77/88	198 A 2.000 <M78>; 198 A 3.000 <M76>	10.07-12.09	DBJ	4	<b>0 445 110 300</b>		
<b>1.9 JTD [182..]</b>	1,9	76	182 B 4.000 <M25>	11.98-09.01	DBB	4	<b>0 445 110 002</b>	<b>0 986 435 001</b>	
			182 B 9.000 <M26>	08.00-09.01	DBB	4	<b>0 445 110 068</b>	<b>0 986 435 083</b>	
JTD 8V [198]	1,9	66/85/88	192 A 8.000 <M88>; 192 B 4.000 <M87>; 192 B 5.000 <M83>	03.07-12.09	DBB	4	<b>0 445 110 276</b>	<b>0 986 435 148</b>	
JTD 16V [198]	1,9	110	937 A 5.000 <M92>	04.07-12.09	DBB	4	<b>0 445 110 243</b>	<b>0 986 435 104</b>	
<b>2.0 JTD [198]</b>	2,0	121	198 A 5.000	03.10→	DBJ	4	<b>0 445 110 299</b>		
JTD 16V [198]	2,0	120	198 A 5.000 <M120>	10.08-12.09	DBJ	4	<b>0 445 110 299</b>		
<b>Croma</b>									
<b>1.9 JTD 8V [194..]</b>	1,9	85	939 A 1.000 <M87>	06.05-09.06	DBB	4	<b>0 445 110 244</b>	<b>0 986 435 161</b>	
				10.06-12.10	DBB	4	<b>0 445 110 276</b>	<b>0 986 435 148</b>	
		88	939 A 1.000 <M88>	06.05-09.06	DBB	4	<b>0 445 110 244</b>	<b>0 986 435 161</b>	
				10.06-12.10	DBB	4	<b>0 445 110 276</b>	<b>0 986 435 148</b>	
JTD 16V [194..]	1,9	100	939 A 1.000 <M91>	12.06-12.10	DBB	4	<b>0 445 110 243</b>	<b>0 986 435 104</b>	
		110	939 A 2.000 <M92>	06.05-12.10	DBB	4	<b>0 445 110 243</b>	<b>0 986 435 104</b>	
<b>2.4 JTD [194..]</b>	2,4	147	939 A 3.000 <M95>	06.05-08.07	DBJ	5	<b>0 445 110 213</b>	<b>0 986 435 162</b>	



<b>Doblo</b>									
1.3 JTD [119..]	1,3	55/62	199 A 2.000 <M73>; 223 A 9.000 <M71>	10.05-12.10	DBB	4	0 445 110 183	0 986 435 102	
JTD [152..]	1,3	66	199 A 2.000 <M72>	10.09→	DBB	4	0 445 110 183	0 986 435 102	
JTD 16V [119..]	1,3	51	188 A 9.000 <M20>	02.04-09.05	DBB	4	0 445 110 083	0 986 435 078	
1.6 JTD [152..]	1,6	66/77	182 B 6.000 <M76>	10.09→	DBJ	4	0 445 110 300		
1.9 JTD [119..]	1,9	74	182 B 9.000 <M15>						
			Mot.Nr. →2805542	10.01-10.01	DBB	4	0 445 110 068	0 986 435 083	
			Mot.Nr. 2805543→	11.01-01.04	DBB	4	0 445 110 119	0 986 435 083	
		74/77	223 B 1.000 <M84>; 223 B 2.000 <M86>	10.05-12.10	DBB	4	0 445 110 187	0 986 435 099	
		77	223 A 7.000 <M16/M30>	11.02-09.05	DBB	4	0 445 110 119	0 986 435 083	
		88	186 A 9.000 <M88>	10.05-12.10	DBB	4	0 445 110 276	0 986 435 148	
2.0 JTD [152..]	2,0	100	<M120>	10.09→	DBJ	4	0 445 110 299		
<b>Doblo Cargo</b>									
1.3 JTD [223..]	1,3	55/62	199 A 2.000 <M73>; 223 A 9.000 <M71>	10.05-12.10	DBB	4	0 445 110 183	0 986 435 102	
JTD [263..]	1,3	66	<M72>	10.09→	DBB	4	0 445 110 183	0 986 435 102	
JTD 16V [223..]	1,3	51	188 A 9.000 <M20>	02.04-09.05	DBB	4	0 445 110 083	0 986 435 078	
1.6 JTD [263..]	1,6	66/77	182 B 6.000 <M76>	10.09→	DBJ	4	0 445 110 300		
1.9 JTD [223..]	1,9	74/77	182 B 9.000 <M15>; 223 A 7.000 <M16/M30>	10.01-09.05	DBB	4	0 445 110 119	0 986 435 083	
			223 B 2.000 <M86>; 223 B 1000 <M84>	10.05-12.10	DBB	4	0 445 110 187	0 986 435 099	
		88	186 A 9.000 <M88>	10.05-12.10	DBB	4	0 445 110 276	0 986 435 148	
2.0 JTD [263..]	2,0	100	<M120>	10.09→	DBJ	4	0 445 110 299		
<b>Fiorino</b>									
1.3 MJTD [225..]	1,3	55	199 A 2.000 <M73>	12.07→	DBB	4	0 445 110 183	0 986 435 102	
<b>Idea</b>									
1.3 JTD 16V [135..]	1,3	52	188 A 9.000 <M30>	01.04→	DBB	4	0 445 110 083	0 986 435 078	
		66	199 A 3.000 <M72>	11.04→	DBB	4	0 445 110 183	0 986 435 102	
1.6 JTD 16V [135..]	1,6	88	350 A 2.000 <M78>	04.08→	DBJ	4	0 445 110 300		
1.9 JTD 8V [135..]	1,9	74	188 B 2.000 <M40>	01.04→	DBB,EU3	4	0 445 110 112	0 986 435 101	
					DBB,EU3	4	0 445 110 187	0 986 435 099	
<b>Linea</b>									
1.3 JTD [110..]	1,3	66	199 A 3.000 <M72>	03.07→	DBB	4	0 445 110 183	0 986 435 102	
1.6 JTD [110..]	1,6	77	198 A 3.000 <M76>	10.08→	DBJ	4	0 445 110 300		
<b>Marea</b>									
1.9 JTD [185..]	1,9	77	182 B 4.000 <M1>	03.99-09.02	DBB	4	0 445 110 002	0 986 435 001	
		81	186 A 6.000 <M4>						
			Mot.Nr. →2805542	08.00-10.01	DBB	4	0 445 110 068	0 986 435 083	
			Mot.Nr. 2805543→	11.01-09.02	DBB	4	0 445 110 119	0 986 435 083	
JTD S.W. [185..]	1,9	74	182 B 9.000 <M5>						
			Mot.Nr. →2805542	10.01-10.01	DBB	4	0 445 110 068	0 986 435 083	
			Mot.Nr. 2805543→	11.01-09.02	DBB	4	0 445 110 119	0 986 435 083	
2.4 JTD [185..]	2,4	100	185 A 6.000 <M3>	03.99-09.02	DBB	5	0 445 110 002	0 986 435 001	
<b>Marengo</b>									
1.9 JTD [285..]	1,9	77	182 B 4.000 <M1>	03.99-09.02	DBB	4	0 445 110 002	0 986 435 001	
		81	186 A 6.000 <M4>						
			Mot.Nr. →2805542	08.00-10.01	DBB	4	0 445 110 068	0 986 435 083	
			Mot.Nr. 2805543→	11.01-09.02	DBB	4	0 445 110 119	0 986 435 083	
<b>Multipla</b>									
1.9 JTD [186..]	1,9	77	182 B 4.000 <M5>	01.99-12.00	DBB	4	0 445 110 002	0 986 435 001	
		81	186 A 6.000 <M6>						
			Mot.Nr. →2805542	08.00-10.01	DBB	4	0 445 110 068	0 986 435 083	
			Mot.Nr. 2805543→	11.01-03.02	DBB	4	0 445 110 119	0 986 435 083	
		85	186 A 8.000 <M7/EU3>	04.02-12.10	DBB	4	0 445 110 119	0 986 435 083	
		85/88	186 A 8.000 <M87/EU4>; 186 A 9.000 <M88/EU4>	10.03-12.10	DBB	4	0 445 110 276	0 986 435 148	
<b>Palio</b>									
1.3 JTD 16V [171..]	1,3	52	188 A 9.000 <M40>	07.03→	DBB	4	0 445 110 083	0 986 435 078	
<b>Palio Weekend</b>									
1.9 JTD [173..]	1,9	57/80	188 A 2.000 <M30>	10.01→	DBB	4	0 445 110 019	0 986 435 006	
<b>Panda</b>									
1.3 , 4x4 [169..]	1,3	52	188 A 8.000	01.09→	DBB	4	0 445 110 083	0 986 435 078	
JTD [169..]	1,3	55	169 A 1.000 <M73>	05.06-12.09	DBB	4	0 445 110 183	0 986 435 102	
JTD, JTD 4x4 [169..]	1,3	52	188 A 8.000 <M10>	01.04-12.09	DBB	4	0 445 110 083	0 986 435 078	





◀ FIAT

Punto									
1.3 MJTD 16V [188]	1,3	52	188 A 9.000 <M20>	07.03-12.10	DBB	4	0 445 110 083	0 986 435 078	
1.9 JTD, JTD 8V [188]	1,9	59/62,5/63	188 A 2.000 <M5>; 188 A 7.000 <M6>; 188 A 7.000 <M25>	07.99-12.10	DBB	4	0 445 110 019	0 986 435 006	
JTD 8V [188]	1,9	74	188 B 2.000 <M30>	07.03-12.10	DBB	4	0 445 110 112	0 986 435 101	
Punto Evo									
1.3 JTD [199]	1,3	55	199 A 2.000 <M73>	10.09→	DBB,EU4	4	0 445 110 183	0 986 435 102	
					DBJ,EU5,SSJ	4	0 445 110 351		
		66	199 A 3.000 <M72>	10.09→	DBB,EU4	4	0 445 110 183	0 986 435 102	
		70	199 B 1.000	10.09→	DBJ,EU5,SSJ	4	0 445 110 351		
1.6 JTD [199]	1,6	88	955 A 3.000 <M78>	10.09→	DBJ	4	0 445 110 300		
Punto Grande									
1.3 MJTD [199]	1,3	55/66	199 A 2.000 <M73>; 199 A 3.000 <M72>	10.05→	DBB	4	0 445 110 183	0 986 435 102	
1.6 JTD [199]	1,6	88	955 A 3.000 <M78>	08.08→	DBJ	4	0 445 110 300		
1.9 JTD [199]	1,9	85/88/96	199 A 5.000 <M89>; 939 A 1.000 <M88>; 939 A 7.000 <M87>	10.05→	DBB	4	0 445 110 276	0 986 435 148	
Punto VAN									
1.3 MJTD 16V [288]	1,3	52	188 A 9.000 <M20>	07.03→	DBB	4	0 445 110 083	0 986 435 078	
1.9 JTD, JTD 8V [288]	1,9	63/85	188 A 7.000 <M6>; 188 A 7.000 <M25>	05.99→	DBB	4	0 445 110 019	0 986 435 006	
Qubo									
1.3 MJTD [300..]	1,3	55	199 A 2.000 <M73>	09.08→	DBB	4	0 445 110 183	0 986 435 102	
Scudo									
1.6 D Multijet [272..]	1,6	66	9HU <M1>	01.07→	DBJ	4	0 445 110 239	0 986 435 122	
2.0 8V JTD [222..]	2,0	70	RHX <M7/M14>	10.99-11.00	DBB,I2G	4	0 445 110 044	0 986 435 003	
			Ricam.Nr →8764		DBJ,I1B	4	0 445 110 008	0 986 435 003	
			Ricam.Nr 8765 →9065	12.00-09.01	DBJ,I1B	4	0 445 110 062	0 986 435 077	
			Ricam.Nr 9066→	10.01-05.04	DBB,KKY	4	0 445 110 076	0 986 435 077	
		70/81	RHX <M14>; RHZ <M13>	06.04-01.07	DBB,KKY	4	0 445 110 076	0 986 435 077	
Sedici									
1.9 JTD, JTD 4x4 [189]	1,9	88	D19AA <M88>	05.06→	DBB	4	0 445 110 276	0 986 435 148	
2.0 JTD, JTD 4x4 [189]	2,0	99	D20AA <M120>	08.09→	DBJ	4	0 445 110 299		
Stilo									
1.9 JTD	1,9	85		06.02-12.07	DBB	4	0 445 110 119	0 986 435 083	
JTD 8V [192..]	1,9	59	192 A 3.000 <M40>	01.04-12.07	DBB	4	0 445 110 119	0 986 435 083	
			Mot.Nr. 2805543→	11.01-12.03	DBB	4	0 445 110 119	0 986 435 083	
		66/85/88	192 A 8.000 <M88>; 192 B 5.000 <M83>; 937 A 7.000 <M87>	07.05-12.07	DBB	4	0 445 110 276	0 986 435 148	
		74	192 A 9.000 <M45>	01.04-12.07	DBB	4	0 445 110 119	0 986 435 083	
		85	192 A 1.000 <M50>	01.04-12.07	DBB	4	0 445 110 119	0 986 435 083	
			Mot.Nr. 2805543→	11.01-12.03	DBB	4	0 445 110 119	0 986 435 083	
JTD 16V [192..]	1,9	93/100/103	192 A 5.000 <M60>; 192 B 1.000 <M62>; 937 A 4.000 <M61>	01.04-12.07	DBB	4	0 445 110 111	0 986 435 081	
		110	937 A 5.000 <M92>	07.05-12.07	DBB	4	0 445 110 243	0 986 435 104	
Stilo Multi Wagon									
1.9 JTD 8V [192..]	1,9	59/85	192 A 1.000 <M50>; 192 A 3.000 <M40>	10.02-12.07	DBB	4	0 445 110 119	0 986 435 083	
		66/85/88	192 A 8.000 <M88>; 192 B 5.000 <M83>; 937 A 7.000 <M87>	07.05-12.07	DBB	4	0 445 110 276	0 986 435 148	
		74	192 A 9.000 <M45>	09.04-12.07	DBB	4	0 445 110 119	0 986 435 083	
JTD 16V [192..]	1,9	93/100/103	192 A 5.000 <M60>; 192 B 1.000 <M62>; 937 A 4.000 <M61>	01.04-12.07	DBB	4	0 445 110 111	0 986 435 081	
		110	937 A 5.000 <M92>	07.05-12.07	DBB	4	0 445 110 243	0 986 435 104	
Strada									
1.3 JTD [278]	1,3	63	223 A 9.000 <M71>	07.05→	DBB	4	0 445 110 183	0 986 435 102	
1.9 JTD [278]	1,9	59	188 A 2.000 <M50>	04.03-06.05	DBB	4	0 445 110 019	0 986 435 006	
Ulysse									
2.0 JTD 8V [121..]	2,0	80	RHZ <M9>	07.99-09.02	DBB,KZG	4	0 445 110 044	0 986 435 003	
					DBJ,KZB	4	0 445 110 008	0 986 435 003	
2.2 16V JTD [179..]	2,2	94	4HW <M10>	10.02-09.07	DBB	4	0 445 110 036	0 986 435 013	
								0 986 435 014	
								0 986 435 015	





<b>500</b>										
1.3 MJTD [150]	1,3	55	169 A 1.000 <M73>	07.07→	DBB	4	0 445 110 183	0 986 435 102		
<b>500 Cabrio</b>										
1.3 MJTD [150]	1,3	55	169 A 1.000	07.09→	DBB	4	0 445 110 183	0 986 435 102		
		70	199 B 1.000	01.10→	<del>DBB</del>	4	0 445 110 351			

**FORD**

<b>C-MAX</b>										
1.6 TDCi [07]	1,6	66	<Duratorq>	03.07-07.10	DBJ	4	0 445 110 239	0 986 435 122		
		80	<Duratorq-TDCi>	03.07-07.10	DBJ	4	0 445 110 259	0 986 435 126		

<b>Fiesta V</b>										
1.6 TDCi [02]	1,6	66	HHJ... <Duratorq TDCi>	11.04-09.08	DBJ	4	0 445 110 239	0 986 435 122		

<b>Fiesta VI</b>										
1.6 TDCi [08]	1,6	55/66	HHJ... <Euro4>; HHJF <Euro4>	07.08→	DBJ	4	0 445 110 239	0 986 435 122		
		55/70	TZJ... <Euro5>; UBJA <Euro5>	03.10→	DBJ	4	0 445 110 340			

<b>Focus C-MAX</b>										
1.6 TDCi [04]	1,6	66	HHD... <Duratorq>	11.04-10.05	DBJ	4	0 445 110 239	0 986 435 122		
		80	G8D... <Duratorq-TDCi>	06.03-10.03	DBJ	4	0 445 110 136	0 986 435 090		
				11.03-10.05	DBJ	4	0 445 110 188	0 986 435 090		
				11.05-03.07	DBJ,EU4	4	0 445 110 259	0 986 435 126		
					DBJ,EU4	4	0 445 110 188	0 986 435 090		

<b>Focus II</b>										
1.6 TDCi [04]	1,6	66	HHD... <Duratorq>	07.04-10.05	DBJ	4	0 445 110 239	0 986 435 122		
		80	G8D... <Duratorq>	07.04-10.05	DBJ	4	0 445 110 188	0 986 435 090		
				11.05-01.08	DBJ,EU4	4	0 445 110 259	0 986 435 126		
					DBJ,EU4	4	0 445 110 188	0 986 435 090		
TDCi [08]	1,6	66	GPD... <Euro4/Euro5>	12.07→	DBJ,EU5	4	0 445 110 352			
					DBJ,EU5	4	0 445 110 239	0 986 435 122		
			HHD... <Euro3/Euro4>	12.07→	DBJ,EU5	4	0 445 110 352			
					DBJ,EU5	4	0 445 110 239	0 986 435 122		
		80	G8D... <Euro3/Euro4/Euro5>	12.07→	DBJ,EU4	4	0 445 110 259	0 986 435 126		
					DBJ,EU5	4	0 445 110 352			

<b>Focus II Turnier</b>										
1.6 TDCi [04]	1,6	66	HHD... <Duratorq>	07.04-10.05	DBJ	4	0 445 110 239	0 986 435 122		
		80	G8D... <Duratorq>	07.04-10.05	DBJ	4	0 445 110 188	0 986 435 090		
				11.05-01.08	DBJ,EU4	4	0 445 110 259	0 986 435 126		
					DBJ,EU4	4	0 445 110 188	0 986 435 090		
TDCi [08]	1,6	66	GPD... <Euro4/Euro5>	12.07→	DBJ,EU5	4	0 445 110 352			
					DBJ,EU5	4	0 445 110 239	0 986 435 122		
			HHD... <Euro3/Euro4>	12.07→	DBJ,EU5	4	0 445 110 352			
					DBJ,EU5	4	0 445 110 239	0 986 435 122		
		80	G8D... <Euro3/Euro4/Euro5>	12.07→	DBJ,EU4	4	0 445 110 259	0 986 435 126		
					DBJ,EU5	4	0 445 110 352			

<b>Fusion</b>										
1.6 TDCi [02]	1,6	66	HHJ... <Euro3/Euro4>	11.04→	DBJ,EE2	4	0 445 110 188	0 986 435 090		
					DBJ,EU4	4	0 445 110 239	0 986 435 122		

<b>Galaxy</b>										
2.2 TDCi [06]	2,2	129	Q4BA <Euro4>	03.08-10.10	DBB	4	0 445 115 025	0 986 435 351		

<b>Ka</b>										
1.3 TDCi [08]	1,3	55	169 A... <Euro4/Euro5>	09.08-10.10	DBB	4	0 445 110 183	0 986 435 102		
				11.10→	<del>DBB</del>	4	0 445 110 351			

<b>Mondeo IV</b>										
2.2 TDCi [07]	2,2	129	Q4BA <Euro4>	03.08-11.10	DBB	4	0 445 115 025	0 986 435 351		

<b>Mondeo IV Turnier</b>										
2.2 TDCi [07]	2,2	129	Q4BA <Euro4>	03.08-11.10	DBB	4	0 445 115 025	0 986 435 351		

<b>S-MAX</b>										
2.2 TDCi [06]	2,2	129	Q4BA <Euro4>	03.08-10.10	DBB	4	0 445 115 025	0 986 435 351		





**GMC (GENERAL MOTORS CORP.)**

Sierra 2500 HD									
6.6	6,6	231	LLY	09.04-08.05	DBJ	8	0 445 120 027	0 986 435 504	
				09.05-08.06	DBJ	8	0 445 120 042	0 986 435 521	
		272	LMM	09.06-08.07	DBJ	8	0 445 120 082		
	4x4	231	LBZ	09.05-08.06	DBJ	8	0 445 120 042	0 986 435 521	
Sierra 3500									
6.6 TD	6,6	231	LLY	09.04-08.05	DBJ	8	0 445 120 027	0 986 435 504	
				09.05-08.06	DBJ	8	0 445 120 042	0 986 435 521	
			4x4	231	LBZ	09.05-08.06	DBJ	8	0 445 120 042
				09.06-08.07	DBJ	8	0 445 120 082		
Sierra 3500 HD									
6.6	6,6	272	LMM	09.06-08.07	DBJ	8	0 445 120 082		

**HONDA**

Accord										
2.2	CTDi [CL/CN/CM]	2,2	103	N22A1						
					Fg.Nr. →3009347	01.04-06.08	DBJ	4	0 445 110 236	0 986 435 145
					Fg.Nr. 3009348→	01.04-06.08	DBJ	4	0 445 110 296	
	i-DTEC, i-DTEC Type S [CU/CW]	2,2	110/132	N22B1; N22B2	07.08→	DBJ	4	0 445 116 006		
Accord Tourer										
2.2	CTDi [CL/CN/CM]	2,2	103	N22A1						
					Fg.Nr. →3103966	01.06-08.08	DBJ	4	0 445 110 236	0 986 435 145
					Fg.Nr. 3103967→	01.06-08.08	DBJ	4	0 445 110 296	
	i-DTEC, i-DTEC Type S [CU/CW]	2,2	110/132	N22B1; N22B2	09.08→	DBJ	4	0 445 116 006		
Civic Hatchback										
2.2	CTDi [FK/FN]	2,2	103	N22A2						
						09.05-08.06	DBJ	4	0 445 110 236	0 986 435 145
						09.06-08.08	DBJ	4	0 445 110 288	
					09.08→	DBJ	4	0 445 110 296		
CR-V										
2.2	CTDi 4x4 [RD]	2,2	103	N22A2						
						02.05-09.06	DBJ	4	0 445 110 236	0 986 435 145
					CTDi 4x4 [RE]		01.07-12.09	DBJ	4	0 445 110 288
	i-DTEC 4x4 [RE]	2,2	110	N22B3	01.10→	DBJ	4	0 445 116 006		
FR-V										
2.2	CTDi [BE]	2,2	103	N22A1						
					Fg.Nr. →1513057	07.05-06.09	DBJ	4	0 445 110 236	0 986 435 145
					Fg.Nr. 1513058→	07.05-06.09	DBJ	4	0 445 110 296	

**HYUNDAI**

Accent									
1.5	CDRi [MC]	1,5	81	D4FA <1.5L-U>	04.06→	DBJ	4	0 445 110 255	0 986 435 152
					CRDi [LC]	1,5	57-60	D3-EA	01.02-06.06
Accent Hatchback									
1.5	CDRi [MC]	1,5	81	D4FA <1.5L-U>	04.06→	DBJ	4	0 445 110 255	0 986 435 152
					CRDi [LC]	1,5	57-60	D3-EA	01.02-06.06
Elantra									
1.6	CRDi [HD]	1,6	85	D4FB <1C 1,6L-U>	08.06→	DBJ	4	0 445 110 255	0 986 435 152
2.0	CRDi [XD]	2,0	83	D4EA <2.0L TCI>	06.01-08.06	DBJ,KKA	4	0 445 110 101	0 986 435 147
Elantra Hatchback									
2.0	CRDi [XD]	2,0	83	D4EA <2.0L TCI>	06.01-08.06	DBJ,KKA	4	0 445 110 101	0 986 435 147
Getz									
1.5	CRDi [TB]	1,5	65/81	D4FA <TDI>; D4FA-L <TDI>	09.05-06.09	DBJ	4	0 445 110 255	0 986 435 152
Grandeur									
2.2	CRDi [TG]	2,2	110-114	D4EB	07.06→	DBJ	4	0 445 110 253	0 986 435 155
ix20									
1.6	CRDi [JC]	1,6	85/94	D4FB <1.6U2>	05.11→	DBJ	4	0 445 110 319	





<b>ix35</b>									
1.7 CRDi [LM]	1,7	85	D4FD <1.7L-U>	09.10→	DBJ	4	0 445 110 410		
<b>ix55</b>									
3.0 V6 CRDi 4x4 [EN]	3,0	176	D6EA <3L-S>	04.09→	DBJ	6	0 445 115 045		
<b>i10</b>									
1.1 CRDi [PA]	1,1	55	D3FA <1.1L-U>	03.08-12.10	DBJ	3	0 445 110 255	0 986 435 152	
<b>i20</b>									
1.4 CRDi [PB/PBT]	1,4	55/66	D4FC <1.4L-U/1.4L U2>	10.08→	DBJ,EU4	4	0 445 110 319		
1.6 CRDi [PB/PBT]	1,6	85/94	D4FB <1.6L-U2>	01.09→	DBJ	4	0 445 110 319		
<b>i30</b>									
1.6 CRDi [FD/FDH]	1,6	66/85	D4FB <1.6L-U/1.6L-U2>	09.07→	DBJ,TW	4	0 445 110 255	0 986 435 152	
		94	D4FB <1.6L-U2>	11.08→	DBJ	4	0 445 110 319		
2.0 CRDi [FD/FDH]	2,0	100-103	D4EA <2.0L-D>	09.07→	DBJ	4	0 445 110 257	0 986 435 156	
<b>i30 CW</b>									
1.6 CRDi [FD/FDH]	1,6	66/85	D4FB <1.6L-U/1.6L-U2>	02.08→	DBJ,TW	4	0 445 110 255	0 986 435 152	
		94	D4FB <1.6L-U2>	11.08→	DBJ	4	0 445 110 319		
2.0 CRDi [FD/FDH]	2,0	100-103	D4EA <2.0L-D>	03.08→	DBJ	4	0 445 110 257	0 986 435 156	
<b>i40</b>									
1.7 CRDi [VF]	1,7	85/100	D4FD <1.7L-U>	04.11→	DBJ	4	0 445 110 410		
<b>i40 CW</b>									
1.7 CRDi [VF]	1,7	85/100	D4FD <1.7L-U>	04.11→	DBJ	4	0 445 110 410		
<b>Matrix</b>									
1.5 CRDi [FC]	1,5	60	D3-EA <TCI>	07.01-01.06	DBJ	3	0 445 110 101	0 986 435 147	
		75	D4FA <TDI>	02.05-08.06	DBJ,I1B	4	0 445 110 222	0 986 435 160	
		81	D4FA-G <TDI>	09.06-10.06	DBJ,EE2, I1B	4	0 445 110 222	0 986 435 160	
					DBJ,N25	4	0 445 110 255	0 986 435 152	
				11.06-04.10	DBJ	4	0 445 110 255	0 986 435 152	
<b>Santa Fe</b>									
2.0 CRDi	2,0	83	<DOHC>	06.00-08.03	DBJ	4	0 445 110 101	0 986 435 147	
CRDi, CRDi 4x4 [SM]	2,0	83	D4EA	01.01-12.05	DBJ	4	0 445 110 101	0 986 435 147	
CRDi-VGT	2,0	83	D4EA	08.03→	DBJ	4	0 445 110 290		
2.2 CRDi, CRDi 4x4 [CM]	2,2	110-114	D4EB <2.2L-D>	03.06-11.09	DBJ	4	0 445 110 253	0 986 435 155	
<b>Santa Fe New</b>									
2.2 VGT CRDi	2,2	153	HTI	11.05→	DBJ	4	0 445 110 253	0 986 435 155	
<b>Solaris</b>									
1.6 CRDi [RB]	1,6	94	D4BF	01.11→	DBJ	4	0 445 110 319		
<b>Sonata</b>									
2.0 CRDi [NF]	2,0	100-103/ 110	D4EA <2L-D TCI SOHC>	01.06-12.10	DBJ	4	0 445 110 257	0 986 435 156	
<b>Trajt</b>									
2.0 CRDi [FO]	2,0	83	D4EA	01.01-06.07	DBJ	4	0 445 110 101	0 986 435 147	
<b>Trajt XG</b>									
2.0 CRDi	2,0	83	D	10.99→	DBJ	4	0 445 110 101	0 986 435 147	
<b>Tucson</b>									
2.0 CRDi, CRDi 4x4 [JM]	2,0	103	D4EA...	09.05-10.08	DBJ,N25	4	0 445 110 257	0 986 435 156	
		110	D4EA	01.09-03.10	DBJ,N25	4	0 445 110 257	0 986 435 156	
VGT CRDi	2,0	115		12.05→	DBJ	4	0 445 110 257	0 986 435 156	
<b>IVECO</b>									
<b>Massif</b>									
3.0	3,0	107/130	F1CE0481F*...; F1CE0481H*...	06.08→	DBJ	4	0 445 110 248	0 986 435 163	





**JEEP**

<b>Cherokee</b>									
2.5 CRD 4x4 [KJ]	2,5	105	ENJ, ENO		03.01-12.04	DBJ	4	0 445 110 059	0 986 435 149
2.8 CRD [KJ]	2,8	112-120	ENR		03.03-12.04	DBJ	4	0 445 110 059	0 986 435 149
					01.05-12.07	DBJ	4	0 445 110 218	
<b>Grand Cherokee</b>									
2.7 CRD [WG]	2,7	120	ENF		10.01-12.04	DBB	5	0 445 110 189	0 986 435 055
<b>Liberty</b>									
2.8 CRD 4x4 [KJ]	2,8	112-120	ENR		08.05-08.06	DBJ	4	0 445 110 217	

**KIA**

<b>Carens</b>									
1.6 CRDi [FG]	1,6	85/94	D4FB <U2>		09.10→	DBJ	4	0 445 110 319	
2.0 CRDi, CRDi VGT [FC]	2,0	83/103	D4EA		04.02-12.06	DBJ	4	0 445 110 101	0 986 435 147
CRDi, CRDi VGT [FG]	2,0	85/100/103	D4EA; D4EA-L; D4EA-W		09.06→	DBJ	4	0 445 110 257	0 986 435 156
<b>Carens II</b>									
2.0 CRDi	2,0	85			02.02-04.06	DBJ	4	0 445 110 101	0 986 435 147
<b>Carens New</b>									
2.0 VGT CRDi	2,0	146			04.06→	DBJ	4	0 445 110 257	0 986 435 156
<b>Carnival</b>									
2.2 CRDi [MB]	2,2	110/143	D4HB <2.2L-R>		10.09→	DBJ	4	0 445 116 017	
<b>Cee'd</b>									
1.6 CRDi [ED/FF2]	1,6	66/85/94	D4FB; D4FB-L		02.09→	DBJ	4	0 445 110 319	
2.0 CRDi [ED/FF2]	2,0	103	D4EA-F		09.07→	DBJ	4	0 445 110 257	0 986 435 156
<b>Cee'd Sporty Wagon</b>									
1.6 CRDi [ED/FF2]	1,6	66/85/94	D4FB; D4FB-L		02.09→	DBJ	4	0 445 110 319	
2.0 CRDi [ED/FF2]	2,0	103	D4EA-F		09.07→	DBJ	4	0 445 110 257	0 986 435 156
<b>Cerato</b>									
1.5 VGT CRDi	1,5	75			06.05→	DBJ	4	0 445 110 222	0 986 435 160
<b>Magentis</b>									
2.0 CRDi [GE]	2,0	103/110	D4EA		02.06→	DBJ	4	0 445 110 257	0 986 435 156
<b>Mohave</b>									
3.0 CRDi	3,0	184	<3.0 S>		01.09→	DBJ	6	0 445 115 045	
<b>Optima</b>									
1.7 CRDi [TF]	1,7	100-103	D4FD		09.11→	DBJ	4	0 445 110 410	
<b>Pride New</b>									
1.5 VGT CRDi	1,5	112			05.05→	DBJ	4	0 445 110 255	0 986 435 152
<b>Pro Cee'd</b>									
1.6 CRDi [ED]	1,6	66/85/94	D4FB; D4FB-FL		02.09→	DBJ	4	0 445 110 319	
2.0 CRDi [ED]	2,0	103	D4EA		03.08→	DBJ	4	0 445 110 257	0 986 435 156
<b>Sorento</b>									
2.2 CRDi, CRDi 4x4 [XM]	2,2	145	D4HB		09.09→	DBJ	4	0 445 116 017	
2.5 CRDi	2,5	107	<A2,51Gen>		05.00-11.03	DBJ	4	0 445 110 091	0 986 435 154
					12.03→	DBJ	4	0 445 110 279	
CRDi [JC]	2,5	103	D4CB		07.02-12.03	DBJ,OKN	4	0 445 110 091	0 986 435 154
					01.04-08.09	DBJ,I1B	4	0 445 110 279	
		125	D4CB		03.06-08.09	DBJ	4	0 445 110 274	
<b>Soul</b>									
1.6 CRDi [AM]	1,6	85/94	D4FB <Euro 4>		01.09→	DBJ	4	0 445 110 319	
<b>Sportage</b>									
1.7 CRDi [SL]	1,7	85	D4FD		09.10→	DBJ	4	0 445 110 410	
2.0 CRDi, CRDi 4x4 [JE]	2,0	83	D4EA		09.04-07.08	DBJ	4	0 445 110 290	
		100-103	D4EA...; D4EA-V		01.06-07.08	DBJ	4	0 445 110 257	0 986 435 156
		110	D4EA		08.08-05.10	DBJ,EU4	4	0 445 110 257	0 986 435 156
CRDi 4x4 [SL]	2,0	135	D4HA		01.11→	DBJ	4	0 445 116 017	
<b>Sportage New</b>									
2.0 CRDi	2,0	100	<D2,0 Gen 1>		08.04-12.05	DBJ,WGT	4	0 445 110 290	
					01.06→	DBJ,VGT	4	0 445 110 257	0 986 435 156
<b>Venga</b>									
1.6 CRDi	1,6	85/94	D4FB <1600 U2>		12.09→	DBJ	4	0 445 110 319	







**LANCIA**

<b>Delta</b>									
1.6 JTD [844]	1,6	88	198 A 2.000 <M78>		07.08→	DBJ	4	<b>0 445 110 300</b>	
1.9 JTD [844]	1,9	140	844 A 1.000 <M94>		08.08→	DBJ	4	<b>0 445 110 299</b>	
2.0 MJTD [844]	2,0	121	198 A 5.000 <M120>		08.08→	DBJ	4	<b>0 445 110 299</b>	
<b>Kappa Berlina</b>									
2.4 JTD [838]	2,4	100	838A8.000 <M3>		03.98-12.00	DBB	5	<b>0 445 110 002</b>	<b>0 986 435 001</b>
<b>Kappa Station Wagon</b>									
2.4 JTD [838]	2,4	100	838A8.000 <M3>		03.98-12.00	DBB	5	<b>0 445 110 002</b>	<b>0 986 435 001</b>
<b>Lybra Berlina</b>									
1.9 JTD [839]	1,9	77	AR32302 <M1 CF2>		10.99-09.00	DBB	4	<b>0 445 110 002</b>	<b>0 986 435 001</b>
		80/85	AR37101 <M2 CF3>; 937A2.000 <M3 CF3>		09.00-11.06	DBB	4	<b>0 445 110 119</b>	<b>0 986 435 083</b>
2.4 JTD [839]	2,4	98	839A5.000/AR32501 <M6/M5 CF2>		10.99-09.00	DBB	5	<b>0 445 110 002</b>	<b>0 986 435 001</b>
		103	839A6.000 <M7 CF3>		09.00-08.01	DBB	5	<b>0 445 110 068</b>	<b>0 986 435 083</b>
					09.01-05.02	DBB	5	<b>0 445 110 119</b>	<b>0 986 435 083</b>
		110	841C000 <M8 CF3>		06.02-09.05	DBB	5	<b>0 445 110 119</b>	<b>0 986 435 083</b>
<b>Lybra Station Wagon</b>									
1.9 JTD [839]	1,9	77	AR32302 <M1 CF2>		10.99-09.00	DBB	4	<b>0 445 110 002</b>	<b>0 986 435 001</b>
		80	AR37101 <M2 CF3>		09.00-06.01	DBB	4	<b>0 445 110 068</b>	<b>0 986 435 083</b>
		85	937A2.000 <M3 CF3>		06.01-11.06	DBB	4	<b>0 445 110 119</b>	<b>0 986 435 083</b>
2.4 JTD [839]	2,4	98	839A5.000/AR32501 <M6/M5 CF2>		10.99-09.00	DBB	5	<b>0 445 110 002</b>	<b>0 986 435 001</b>
		103	839A6.000 <M7 CF3>		09.00-08.01	DBB	5	<b>0 445 110 068</b>	<b>0 986 435 083</b>
					09.01-05.02	DBB	5	<b>0 445 110 119</b>	<b>0 986 435 083</b>
		110	841C000 <M8 CF3>		06.02-09.05	DBB	5	<b>0 445 110 119</b>	<b>0 986 435 083</b>
<b>Musa</b>									
1.3 MJTD [184]	1,3	51	188A9000 <M30>		10.04→	DBB	4	<b>0 445 110 083</b>	<b>0 986 435 078</b>
MJTD 16V [184]	1,3	66	199A3000 <M72>		01.06→	DBB	4	<b>0 445 110 183</b>	<b>0 986 435 102</b>
		70	199B1000		02.10→	DBJ	4	<b>0 445 110 351</b>	
1.6 JTD [184]	1,6	85/88	350A2000 <M78>; 350A3000 <M77>		10.07→	DBJ	4	<b>0 445 110 300</b>	
1.9 JTD [184]	1,9	74	188B2000 <M40>		10.04→	DBB	4	<b>0 445 110 187</b>	<b>0 986 435 099</b>
<b>Phedra</b>									
2.2 JTD 16V [180]	2,2	95	4HW <M10>		09.02-09.07	DBB	4	<b>0 445 110 036</b>	<b>0 986 435 013</b>
									<b>0 986 435 014</b>
									<b>0 986 435 015</b>
		125	4HT <M11>; 4H01 <M12/M13>		10.07-12.10	DBB	4	<b>0 445 115 025</b>	<b>0 986 435 351</b>
<b>Thesis</b>									
2.4 JTD 10V [841]	2,4	110	841C.000 <M20>		04.02-02.05	DBB	5	<b>0 445 110 119</b>	<b>0 986 435 083</b>
JTD 20V [841]	2,4	120/129	841G.000 <M24>; 841H.000 <M25>; 841M.000 <M22>; 841N.000 <M23>		06.03-02.06	DBB	5	<b>0 445 110 111</b>	<b>0 986 435 081</b>
		136	841P.000 <M99 CF4>		03.06-12.09	DBJ	5	<b>0 445 110 213</b>	<b>0 986 435 162</b>
<b>Ypsilon</b>									
1.3 JTD 16V [843]	1,3	51	188A9000 <M15>		06.03-09.06	DBB	4	<b>0 445 110 083</b>	<b>0 986 435 078</b>
Multijet 16V [843]	1,3	55	199A2000 <M75>		10.09→	DBJ	4	<b>0 445 110 351</b>	
		55/66	199A2000 <M73>; 199A3000 <M72>		10.06→	DBB	4	<b>0 445 110 183</b>	<b>0 986 435 102</b>
		77	199A3000 <M105>		10.06→	DBJ	4	<b>0 445 110 322</b>	
Multijet 16V [846]	1,3	70	199B1000		06.11→	DBJ	4	<b>0 445 110 351</b>	
<b>ZETA</b>									
2.0 JTD [122]	2,0	80	RHZ <M4>		06.99-06.02	DBJ	4	<b>0 445 110 008</b>	<b>0 986 435 003</b>

**LAND ROVER GROUP**

<b>Freelander</b>									
2.0 TD4 [LN]	2,0	80-82	204D3/TD4						
			Fg.Nr. →3A239591		09.01-03.07	DBJ	4	<b>0 445 110 049</b>	<b>0 986 435 095</b>
			Fg.Nr. 3A239592→		09.01-03.07	AG,DBJ	4	<b>0 445 110 130</b>	<b>0 986 435 096</b>
						DBJ,GS	4	<b>0 445 110 049</b>	<b>0 986 435 095</b>
<b>Freelander II</b>									
2.2 Td4	2,2	110-118	224DT						
			Fg.Nr. BH000001→		10.06→	DBJ	4	<b>0 445 116 043</b>	
			Fg.Nr. →AH999999		10.06→	DBJ	4	<b>0 445 115 042</b>	<b>0 986 435 362</b>





◀ LAND ROVER GROUP

<b>Range Rover Evoque</b>									
2.2 SD4	2,2	140			09.11→	DBJ	4	<b>0 445 116 043</b>	
<b>Range Rover III</b>									
3.0 Td6	2,9	130	M57 D30		03.02-09.06	DBJ	6	<b>0 445 110 266</b>	<b>0 986 435 022</b>

**MAZDA**

<b>BT-50</b>									
2.5 D Turbo, D Turbo 4x4 [UN]	2,5	105	WLC <DuraTORQ TDCi>; WL3 <DuraTORQ TDCi>		03.06→	<del>DBJ</del>	4	<b>0 445 110 250</b>	
3.0 D Turbo, D Turbo 4x4 [UN]	3,0	115	WEC <DuraTORQ TDCi>		03.06→	<del>DBJ</del>	4	<b>0 445 110 249</b>	
<b>2</b>									
1.6 CD [DE]	1,6	66	Y6 Fg.Nr. →DEA4**400000 →DEA3**300000		11.08-07.10	DBJ	4	<b>0 445 110 239</b>	<b>0 986 435 122</b>
<b>3</b>									
1.6 MZ-CD [BK]	1,6	80	Y6		12.03-03.06	DBJ	4	<b>0 445 110 188</b>	<b>0 986 435 090</b>
					04.06-12.08	DBJ	4	<b>0 445 110 259</b>	<b>0 986 435 126</b>
MZR-CD [BL]	1,6	80-81	Y6		12.08→	DBJ	4	<b>0 445 110 188</b>	<b>0 986 435 090</b>
<b>3 Hatchback</b>									
1.6 MZ-CD [BK]	1,6	66	Y6 Fg.Nr. 605426→		10.05-12.08	DBJ,EU3	4	<b>0 445 110 188</b>	<b>0 986 435 090</b>
					04.06-12.08	DBJ	4	<b>0 445 110 239</b>	<b>0 986 435 122</b>
		80	Y6		12.03-03.06	DBJ	4	<b>0 445 110 188</b>	<b>0 986 435 090</b>
					04.06-12.08	DBJ	4	<b>0 445 110 259</b>	<b>0 986 435 126</b>
MZR-CD [BL]	1,6	80-81	Y6		12.08→	DBJ	4	<b>0 445 110 188</b>	<b>0 986 435 090</b>

**MERCEDES-BENZ**

<b>Serie A</b>									
160 CDI [168]	1,7	44	OM 668.941 <DE 17 A>						
			Mot.Nr. →30 210110		09.98-02.01	<del>DBJ</del>	4	<b>0 445 110 014</b>	<b>0 986 435 005</b>
			Mot.Nr. 30 210111→30 368241		09.98-02.01	DBB	4	<b>0 445 110 115</b>	<b>0 986 435 049</b>
			Mot.Nr. 30 368242→		09.98-02.01	DBB	4	<b>0 445 110 195</b>	<b>0 986 435 057</b>
		55	OM 668.940 <DE 17 LA>						
			Mot.Nr. →30 210110		03.01-08.04	<del>DBJ</del>	4	<b>0 445 110 014</b>	<b>0 986 435 005</b>
			Mot.Nr. 30 210111→30 368241		03.01-08.04	DBB	4	<b>0 445 110 115</b>	<b>0 986 435 049</b>
			Mot.Nr. 30 368242→		03.01-08.04	DBB	4	<b>0 445 110 195</b>	<b>0 986 435 057</b>
CDI [169]	2,0	60	OM 640.942 <DE 20 LA>		09.04→	DBB,WAS	4	<b>0 445 110 166</b>	<b>0 986 435 117</b>
			Komp.Nr. 801					<b>0 986 435 118</b>	
						DBB,WAS	4	<b>0 445 110 323</b>	
			Komp.Nr. 801		09.04→	DBB	4	<b>0 445 110 377</b>	
170 CDI [168]	1,7	66	OM 668.940 <DE 17 LA>						
			Mot.Nr. →30 210110		07.98-02.01	<del>DBJ</del>	4	<b>0 445 110 014</b>	<b>0 986 435 005</b>
			Mot.Nr. 30 210111→30 368241		07.98-02.01	DBB	4	<b>0 445 110 115</b>	<b>0 986 435 049</b>
			Mot.Nr. 30 368242→		07.98-02.01	DBB	4	<b>0 445 110 195</b>	<b>0 986 435 057</b>
		70	OM 668.942 <DE 17 LA>						
			Mot.Nr. →30 210110		03.01-08.04	<del>DBJ</del>	4	<b>0 445 110 014</b>	<b>0 986 435 005</b>
			Mot.Nr. 30 210111→30 368241		03.01-08.04	DBB	4	<b>0 445 110 115</b>	<b>0 986 435 049</b>
			Mot.Nr. 30 368242→		03.01-08.04	DBB	4	<b>0 445 110 195</b>	<b>0 986 435 057</b>
180 CDI [169]	2,0	80	OM 640.940 <DE 20 LA>		09.04→	DBB,WAS	4	<b>0 445 110 166</b>	<b>0 986 435 117</b>
			Komp.Nr. 801					<b>0 986 435 118</b>	
						DBB,WAS	4	<b>0 445 110 323</b>	
			Komp.Nr. 801		09.04→	DBB	4	<b>0 445 110 377</b>	
200 CDI [169]	2,0	103	OM 640.941 <DE 20 LA>		09.04→	DBB,WAS	4	<b>0 445 110 166</b>	<b>0 986 435 117</b>
			Komp.Nr. 801					<b>0 986 435 118</b>	
						DBB,WAS	4	<b>0 445 110 323</b>	
			Komp.Nr. 801		09.04→	DBB	4	<b>0 445 110 377</b>	





Serie B										
180 CDI [245]	2,0	80	OM 640.940 <DE 20 LA>	04.05→	DBB,WAS	4	0 445 110 166	0 986 435 117		
			Komp.Nr. 801							0 986 435 118
					DBB,WAS		4	0 445 110 323		
200 CDI [245]	2,0	103	OM 640.941 <DE 20 LA>	04.05→	DBB,WAS	4	0 445 110 166	0 986 435 117		
			Komp.Nr. 801							0 986 435 118
					DBB,WAS		4	0 445 110 323		
			Komp.Nr. 801	04.05→	DBB	4	0 445 110 377			
Serie C										
30 AMG CDI [203]	3,0	170	OM 612.990 <DE 30 LA AMG>	01.03-08.04	DBB	5	0 445 110 151			
200 CDI [202]	2,2	75	OM 611.960 <DE LA>	03.98-04.00	DBB	4	0 445 110 011	0 986 435 004		
CDI [203]	2,2	75/90	OM 646.962 <DE 22 LA>	03.03-07.07	DBB	4	0 445 110 176	0 986 435 111		
			85	OM 611.962 <DE LA>						
				Mot.Nr. →30 314413 →40 059864	10.00-02.03	DBB	4	0 445 110 024	0 986 435 020	
				Mot.Nr. 30 314414→30 445712	10.00-02.03	DBB	4	0 445 110 199	0 986 435 061	
				40 059865→40 068033						
			Mot.Nr. 30 445713→ 40 068034→	10.00-02.03	AG,DBB	4	0 445 110 205	0 986 435 067		
220 CDI [202]	2,2	92	OM 611.960 <DE LA>	12.97-04.00	DBB	4	0 445 110 011	0 986 435 004		
CDI [203]	2,2	100-105	OM 611.962 <DE LA>							
				Mot.Nr. →30 314413 →40 059864	05.00-02.03	DBB	4	0 445 110 024	0 986 435 020	
				Mot.Nr. 30 314414→30 445712	05.00-02.03	DBB	4	0 445 110 199	0 986 435 061	
				40 059865→40 068033						
				Mot.Nr. 30 445713→ 40 068034→	05.00-02.03	AG,DBB	4	0 445 110 205	0 986 435 067	
					DBB,GS	4	0 445 110 099	0 986 435 041		
		110	OM 646.963 <DE 22 LA>	03.03-02.07	DBB	4	0 445 110 176	0 986 435 111		
270 CDI [203]	2,7	125	OM 612.962 <DE LA>							
				Mot.Nr. →..067962	12.00-08.04	DBB	5	0 445 110 024	0 986 435 020	
				Mot.Nr. 30 133152→	12.00-08.04	AG,DBB	5	0 445 110 120	0 986 435 051	
						DBB,GS	5	0 445 110 199	0 986 435 061	
			Mot.Nr. ..067963→..133151	12.00-08.04	DBB	5	0 445 110 199	0 986 435 061		
320 CDI [203]	3,0	165	OM 642.910 <D 30>	09.04-05.07	DBB	6	0 445 115 063	0 986 435 355		
CDI [204]	3,0	165	OM 642.960 <D 30>	06.07-04.09	DBB	6	0 445 115 063	0 986 435 355		
CDI 4MATIC [204]	3,0	165	OM 642.961 <D 30>							
				Mot.Nr. →..40820980	07.07-11.08	DBB	6	0 445 115 063	0 986 435 355	
				Mot.Nr. ..40820981→	12.08-04.09	DBB	6	0 445 115 075		
350 CDI [204]	3,0	170	OM 642.830 <D 30 LHD>	10.09-01.11	DBB	6	0 445 116 025			
			195	OM 642.834	02.11→	DBB	6	0 445 116 025		
				OM 642.961 <D 30>	05.09-09.09	DBB	6	0 445 115 075		
CDI 4MATIC [204]	3,0	170	OM 642.832 <D 30 LHD>	10.09→	DBB,SCJ	6	0 445 116 025			
						DBB,SCJ	6	0 445 115 059		
Serie C (Sportcoupe)										
30 AMG CDI [203]	3,0	170	OM 612.990 <DE 30 LA AMG>	09.02-08.04	DBB	5	0 445 110 151			
200 CDI [203]	2,2	90	OM 646.962 <DE 22 LA>	03.03-02.08	DBB,MPPR	4	0 445 110 237	0 986 435 139		
					DBB,MPPR	4	0 445 110 176	0 986 435 111		
220 CDI [203]	2,2	105	OM 611.962 <DE LA>							
				Mot.Nr. →30 314413 →40 059864	01.01-02.03	DBB	4	0 445 110 024	0 986 435 020	
				Mot.Nr. 30 314414→30 445712	01.01-02.03	DBB	4	0 445 110 199	0 986 435 061	
				40 059865→40 068033						
				Mot.Nr. 30 445713→ 40 068034→	01.01-02.03	AG,DBB	4	0 445 110 205	0 986 435 067	
					DBB,GS	4	0 445 110 099	0 986 435 041		
		110	OM 646.963 <DE 22 LA>	03.03-02.08	DBB,MPPR	4	0 445 110 237	0 986 435 139		
					DBB,MPPR	4	0 445 110 176	0 986 435 111		
Serie C (T-Modell)										
30 AMG CDI [203]	3,0	170	OM 612.990 <DE 30 LA AMG>	01.03-08.04	DBB	5	0 445 110 151			
200 CDI [202]	2,2	75	OM 611.960 <DE LA>	03.98-02.01	DBB	4	0 445 110 011	0 986 435 004		
CDI [203]	2,2	75/90	OM 646.962 <DE 22 LA>	03.03-08.07	DBB	4	0 445 110 176	0 986 435 111		
			85	OM 611.962 <DE LA>						
				Mot.Nr. →30 314413 →40 059864	10.01-02.03	DBB	4	0 445 110 024	0 986 435 020	
				Mot.Nr. 30 314414→30 445712	10.01-02.03	DBB	4	0 445 110 199	0 986 435 061	
				40 059865→40 068033						
			Mot.Nr. 30 445713→ 40 068034→	10.01-02.03	AG,DBB	4	0 445 110 205	0 986 435 067		
					DBB,GS	4	0 445 110 099	0 986 435 041		





◀ MERCEDES-BENZ

<b>220 CDI [202]</b>	2,2	92	OM 611.960 <DE LA>	12.97-02.01	DBB	4	<b>0 445 110 011</b>	<b>0 986 435 004</b>	
CDI [203]	2,2	105	OM 611.962 <DE LA>						
			Mot.Nr. →30 314413 →40 059864	01.01-02.03	DBB	4	<b>0 445 110 024</b>	<b>0 986 435 020</b>	
			Mot.Nr. 30 314414→30 445712	01.01-02.03	DBB	4	<b>0 445 110 199</b>	<b>0 986 435 061</b>	
			40 059865→40 068033						
			Mot.Nr. 30 445713→ 40 068034→	01.01-02.03	AG,DBB	4	<b>0 445 110 205</b>	<b>0 986 435 067</b>	
					DBB,GS	4	<b>0 445 110 099</b>	<b>0 986 435 041</b>	
		110	OM 646.963 <DE 22 LA>	03.03-08.07	DBB	4	<b>0 445 110 176</b>	<b>0 986 435 111</b>	
<b>270 CDI [203]</b>	2,7	125	OM 612.962 <DE LA>						
			Mot.Nr. →..067962	01.01-08.04	DBB	5	<b>0 445 110 024</b>	<b>0 986 435 020</b>	
			Mot.Nr. 30 133152→	01.01-08.04	AG,DBB	5	<b>0 445 110 120</b>	<b>0 986 435 051</b>	
					DBB,GS	5	<b>0 445 110 199</b>	<b>0 986 435 061</b>	
			Mot.Nr. ..067963→..133151	01.01-08.04	DBB	5	<b>0 445 110 199</b>	<b>0 986 435 061</b>	
<b>320 CDI [203]</b>	3,0	165	OM 642.910 <D 30>	09.04-08.07	DBB	6	<b>0 445 115 063</b>	<b>0 986 435 355</b>	
CDI [204]	3,0	165	OM 642.960 <D 30>	09.07-04.09	DBB	6	<b>0 445 115 063</b>	<b>0 986 435 355</b>	
CDI 4MATIC [204]	3,0	165	OM 642.961 <D 30>						
			Mot.Nr. →..40820980	09.07-11.08	DBB	6	<b>0 445 115 063</b>	<b>0 986 435 355</b>	
			Mot.Nr. ..40820981→	12.08-04.09	<del>DBB</del>	6	<b>0 445 115 075</b>		
<b>350 CDI [204]</b>	3,0	170	OM 642.830 <D 30 LHD REPO>	10.09-01.11	DBB	6	<b>0 445 116 025</b>		
		195	OM 642.834	02.11→	DBB	6	<b>0 445 116 025</b>		
CDI 4MATIC [204]	3,0	170	OM 642.832 <D 30 LHD REPO>	10.09→	DBB, <del>SCJ</del>	6	<b>0 445 116 025</b>		
					DBB,SCJ	6	<b>0 445 115 059</b>		
<b>Serie CLC</b>									
<b>200 CDI [203]</b>	2,2	90	OM 646.962 <DE 22 LA>	03.08-05.10	DBB, <del>MPR</del>	4	<b>0 445 110 237</b>	<b>0 986 435 139</b>	
					DBB,MPR	4	<b>0 445 110 176</b>	<b>0 986 435 111</b>	
<b>220 CDI [203]</b>	2,2	110	OM 646.963 <DE 22 LA>	03.08-05.10	DBB, <del>MPR</del>	4	<b>0 445 110 237</b>	<b>0 986 435 139</b>	
					DBB,MPR	4	<b>0 445 110 176</b>	<b>0 986 435 111</b>	
<b>Serie CLK (Cabrio)</b>									
<b>320 CDI [209]</b>	3,0	165	OM 642.910 <D 30>						
			Mot.Nr. →40820980	04.05-11.08	DBB	6	<b>0 445 115 063</b>	<b>0 986 435 355</b>	
			Mot.Nr. ..40820981→	12.08-12.09	<del>DBB</del>	6	<b>0 445 115 075</b>		
<b>Serie CLK (Coupé)</b>									
<b>220 CDI [209]</b>	2,1	110	OM 646.966 <DE 22 LA>	04.05-04.09	DBB,EU3	4	<b>0 445 110 176</b>	<b>0 986 435 111</b>	
					DBB,EU4	4	<b>0 445 110 237</b>	<b>0 986 435 139</b>	
<b>270 CDI [209]</b>	2,7	125	OM 612.962;967 <DE LA>						
			Mot.Nr. →30 067962	09.02-03.05	DBB	5	<b>0 445 110 024</b>	<b>0 986 435 020</b>	
			Mot.Nr. 30 133152→	09.02-03.05	AG,DBB	5	<b>0 445 110 120</b>	<b>0 986 435 051</b>	
					DBB,GS	5	<b>0 445 110 199</b>	<b>0 986 435 061</b>	
			Mot.Nr. ..067963→..133151	09.02-03.05	DBB	5	<b>0 445 110 199</b>	<b>0 986 435 061</b>	
<b>320 CDI [209]</b>	3,0	165	OM 642.910 <D 30>						
			Mot.Nr. →40820980	04.05-11.08	DBB	6	<b>0 445 115 063</b>	<b>0 986 435 355</b>	
			Mot.Nr. ..40820981→	12.08-04.09	<del>DBB</del>	6	<b>0 445 115 075</b>		
<b>Serie CLS</b>									
<b>320 CDI [219]</b>	3,0	165	OM 642.920 <D 30>						
			Mot.Nr. →..40820980	05.05-11.08	DBB	6	<b>0 445 115 063</b>	<b>0 986 435 355</b>	
			Mot.Nr. ..40820981→	12.08-04.09	<del>DBB</del>	6	<b>0 445 115 075</b>		
<b>350 CDI [219]</b>	3,0	165	OM 642.920 <D 30>	05.09-09.09	<del>DBB</del>	6	<b>0 445 115 075</b>		
CDI, CDI 4MATIC [218]	3,0	195	OM 642.853 <D 30 LHD>; OM 642.854 <D 30 LHD REPO GEST>	10.10→	DBB	6	<b>0 445 116 025</b>		
<b>Serie E</b>									
<b>200 CDI [210]</b>	2,1	85	OM 611.961 <DE LA>	07.99-08.99	DBB	4	<b>0 445 110 011</b>	<b>0 986 435 004</b>	
			Mot.Nr. →30 314413 →40 059864	09.99-03.02	DBB	4	<b>0 445 110 024</b>	<b>0 986 435 020</b>	
			Mot.Nr. 30 314414→30 445712	09.99-03.02	DBB	4	<b>0 445 110 199</b>	<b>0 986 435 061</b>	
			40 059865→40 068033						
			Mot.Nr. 30 445713→ 40 068034→	09.99-03.02	AG,DBB	4	<b>0 445 110 205</b>	<b>0 986 435 067</b>	
					DBB,GS	4	<b>0 445 110 099</b>	<b>0 986 435 041</b>	
	2,2	75	OM 611.961 <DE LA>	07.98-08.99	DBB	4	<b>0 445 110 011</b>	<b>0 986 435 004</b>	
				09.99-03.02	DBB	4	<b>0 445 110 024</b>	<b>0 986 435 020</b>	
CDI [211]	2,1	75/90	OM 646.951 <DE 22 LA>						
			Mot.Nr. →30 045955	07.02-09.08	DBB	4	<b>0 445 110 054</b>	<b>0 986 435 133</b>	
			Mot.Nr. 30 045956→30 112421	07.02-09.08	DBB	4	<b>0 445 110 155</b>	<b>0 986 435 135</b>	
			Mot.Nr. 30 112422→	07.02-09.08	DBB	4	<b>0 445 110 176</b>	<b>0 986 435 111</b>	





<b>220</b> CDI [210]	2,1	100-105	OM 611.961 <DE LA>	07.99-08.99	DBB	4	<b>0 445 110 011</b>	<b>0 986 435 004</b>	
			Mot.Nr. →30 314413 →40 059864	09.99-03.02	DBB	4	<b>0 445 110 024</b>	<b>0 986 435 020</b>	
			Mot.Nr. 30 314414→30 445712	09.99-03.02	DBB	4	<b>0 445 110 199</b>	<b>0 986 435 061</b>	
			40 059865→40 068033						
			Mot.Nr. 30 445713→ 40 068034→	09.99-03.02	AG,DBB	4	<b>0 445 110 205</b>	<b>0 986 435 067</b>	
					DBB,GS	4	<b>0 445 110 099</b>	<b>0 986 435 041</b>	
	2,2	92	OM 611.961 <DE LA>	07.98-05.99	DBB	4	<b>0 445 110 011</b>	<b>0 986 435 004</b>	
CDI [211]	2,1	100/110	OM 646.961 <DE 22 LA>						
			Mot.Nr. →30 045955	03.02-01.09	DBB	4	<b>0 445 110 054</b>	<b>0 986 435 133</b>	
			Mot.Nr. 30 045956→30 112421	03.02-01.09	DBB	4	<b>0 445 110 155</b>	<b>0 986 435 135</b>	
			Mot.Nr. 30 112422→	03.02-01.09	DBB	4	<b>0 445 110 176</b>	<b>0 986 435 111</b>	
<b>270</b> CDI [210]	2,7	125	OM 612.961 <DE LA>						
			Mot.Nr. →..067962	06.99-03.02	DBB	5	<b>0 445 110 024</b>	<b>0 986 435 020</b>	
			Mot.Nr. ..067963→..133151	06.99-03.02	DBB	5	<b>0 445 110 199</b>	<b>0 986 435 061</b>	
			Mot.Nr. ..133152→	06.99-03.02	AG,DBB	5	<b>0 445 110 205</b>	<b>0 986 435 067</b>	
			Mot.Nr. ..133152→..188098	06.99-03.02	DBB,GS	5	<b>0 445 110 199</b>	<b>0 986 435 061</b>	
			Mot.Nr. ..188099→	06.99-03.02	DBB,GS	5	<b>0 445 110 099</b>	<b>0 986 435 041</b>	
CDI [211]	2,7	130	OM 647.961 <DE 27 LA>						
			Mot.Nr. →30041540	03.02-03.05	DBB	5	<b>0 445 110 054</b>	<b>0 986 435 133</b>	
			Mot.Nr. 30041541→30107211	03.02-03.05	DBB	5	<b>0 445 110 155</b>	<b>0 986 435 135</b>	
			Mot.Nr. 30107212→	03.02-03.05	DBB	5	<b>0 445 110 176</b>	<b>0 986 435 111</b>	
<b>280</b> CDI [211]	3,2	130	OM 648.961 <DE 32 LA>	04.04-03.05	DBB	6	<b>0 445 110 176</b>	<b>0 986 435 111</b>	
CDI, CDI 4MATIC [211]	3,0	140	OM 642.920 <D 30>; OM 642.921 <D 30>	04.05-03.09	DBB	6	<b>0 445 115 063</b>	<b>0 986 435 355</b>	
<b>300</b> CDI [212]	3,0	150	OM 642.850 <D 30 LHD REPO>	12.09-12.10	DBB	6	<b>0 445 116 025</b>		
		170	OM 642.850 <D 30 LHD REPO>	01.11→	DBB,SCJ	6	<b>0 445 116 025</b>		
						DBB,SCJ	6	<b>0 445 115 059</b>	
			OM 642.852 <D 30 LHD REPO.GEST.>	08.11→	DBB	6	<b>0 445 116 025</b>		
<b>320</b> CDI [210]	3,2	145	OM 613.961 <DE LA>	06.99-03.02	DBB	6	<b>0 445 110 095</b>	<b>0 986 435 037</b>	
CDI [211]	3,2	150	OM 648.961 <DE 32 LA>						
			Mot.Nr. →30042543	11.02-08.03	DBB	6	<b>0 445 110 155</b>	<b>0 986 435 135</b>	
			Mot.Nr. 30042544→	09.03-08.06	DBB	6	<b>0 445 110 176</b>	<b>0 986 435 111</b>	
CDI, CDI 4MATIC [211]	3,0	165	OM 642.920 <D 30>; OM 642.921 <D 30>	04.05-03.09	DBB	6	<b>0 445 115 063</b>	<b>0 986 435 355</b>	
<b>350</b> BlueTec [212]	3,0	155	OM 642.850 <D 30>	04.09→	DBB	6	<b>0 445 115 059</b>		
CDI, CDI 4MATIC [212]	3,0	170	OM 642.850 <D 30 LL>; OM 642.856 <D 30>	08.08-11.10	DBB	6	<b>0 445 116 025</b>		
		195	OM 642.852 <D 30 LL>; OM 642.858 <D 30 LHD REP GEST>	12.10→	DBB	6	<b>0 445 116 025</b>		
<b>400</b> CDI [211]	4,0	191	OM 628.961 <DE 40 LA>						
			Mot.Nr. →40033944	02.03-04.05	DBB	8	<b>0 445 110 103</b>	<b>0 986 435 043</b>	
			Mot.Nr. 40033945→	02.03-04.05	DBB	8	<b>0 445 110 207</b>	<b>0 986 435 069</b>	
<b>420</b> CDI [211]	4,0	231	OM 629.910 <DE 40 LL>	09.05-01.09	DBB	8	<b>0 445 115 014</b>		
<b>Serie E (Cabrio)</b>									
<b>350</b> CDI [207]	3,0	170	OM 642.836 <D 30 LHD REPO>	01.10-01.11	DBB	6	<b>0 445 116 025</b>		
		195	OM 642.838 <D 30 LHD REPO.GEST.>	04.11→	DBB	6	<b>0 445 116 025</b>		
<b>Serie E (Coupé)</b>									
<b>350</b> CDI [207]	3,0	170/195	OM 642.836 <D 30>; OM 642.838 <D 30 LHD REPO.GEST.>	02.09→	DBB	6	<b>0 445 116 025</b>		
<b>Serie E (T-Modell)</b>									
<b>220</b> CDI [210]	2,1	100-105	OM 611.961 <DE LA>	07.99-08.99	DBB	4	<b>0 445 110 011</b>	<b>0 986 435 004</b>	
			Mot.Nr. →30 314413 →40 059864	09.99-01.03	DBB	4	<b>0 445 110 024</b>	<b>0 986 435 020</b>	
			Mot.Nr. 30 314414→30 445712	09.99-01.03	DBB	4	<b>0 445 110 199</b>	<b>0 986 435 061</b>	
			40 059865→40 068033						
			Mot.Nr. 30 445713→ 40 068034→	09.99-01.03	AG,DBB	4	<b>0 445 110 205</b>	<b>0 986 435 067</b>	
					DBB,GS	4	<b>0 445 110 099</b>	<b>0 986 435 041</b>	
	2,2	92	OM 611.961 <DE LA>	07.98-05.99	DBB	4	<b>0 445 110 011</b>	<b>0 986 435 004</b>	
CDI [211]	2,1	100/110	OM 646.961 <DE 22 LA>						
			Mot.Nr. →30 045955	02.03-08.09	DBB	4	<b>0 445 110 054</b>	<b>0 986 435 133</b>	
			Mot.Nr. 30 045956→30 112421	02.03-08.09	DBB	4	<b>0 445 110 155</b>	<b>0 986 435 135</b>	
			Mot.Nr. 30 112422→	02.03-08.09	DBB	4	<b>0 445 110 176</b>	<b>0 986 435 111</b>	





◀ MERCEDES-BENZ

<b>270</b> CDI [210]	2,7	125	OM 612.961 <DE LA>						
			Mot.Nr. →..067962	06.99-01.03	DBB	5	<b>0 445 110 024</b>	<b>0 986 435 020</b>	
			Mot.Nr. ...067963→..133151	06.99-01.03	DBB	5	<b>0 445 110 199</b>	<b>0 986 435 061</b>	
			Mot.Nr. ...133152→	06.99-01.03	AG,DBB	5	<b>0 445 110 205</b>	<b>0 986 435 067</b>	
			Mot.Nr. ...133152→..188098	06.99-01.03	DBB,GS	5	<b>0 445 110 199</b>	<b>0 986 435 061</b>	
			Mot.Nr. ...188099→	06.99-01.03	DBB,GS	5	<b>0 445 110 099</b>	<b>0 986 435 041</b>	
CDI [211]	2,7	130	OM 647.961 <DE 27 LA>						
			Mot.Nr. →30041540	02.03-03.05	DBB	5	<b>0 445 110 054</b>	<b>0 986 435 133</b>	
			Mot.Nr. 30041541→30107211	02.03-03.05	DBB	5	<b>0 445 110 155</b>	<b>0 986 435 135</b>	
			Mot.Nr. 30107212→	02.03-03.05	DBB	5	<b>0 445 110 176</b>	<b>0 986 435 111</b>	
<b>280</b> CDI [211]	3,2	130	OM 648.961 <DE 32 LA>	04.04-03.05	DBB	6	<b>0 445 110 176</b>	<b>0 986 435 111</b>	
CDI, CDI 4MATIC [211]	3,0	140	OM 642.920 <D 30>; OM 642.921 <D 30>	04.05-08.09	DBB	6	<b>0 445 115 063</b>	<b>0 986 435 355</b>	
<b>300</b> CDI [212]	3,0	150	OM 642.850 <D 30 LHD REPO>	12.09-12.10	DBB	6	<b>0 445 116 025</b>		
		170	OM 642.850 <D 30 LHD REPO>	01.11→	DBB,SCJ	6	<b>0 445 116 025</b>		
					DBB,SCJ	6	<b>0 445 115 059</b>		
			OM 642.852 <D 30 LHD REPO.GEST.>	08.11→	DBB	6	<b>0 445 116 025</b>		
<b>320</b> CDI [210]	3,2	145	OM 613.961 <DE LA>	07.99-01.03	DBB	6	<b>0 445 110 095</b>	<b>0 986 435 037</b>	
CDI [211]	3,2	150	OM 648.961 <DE 32 LA>						
			Mot.Nr. →30042543	02.03-08.03	DBB	6	<b>0 445 110 155</b>	<b>0 986 435 135</b>	
			Mot.Nr. 30042544→	09.03-03.05	DBB	6	<b>0 445 110 176</b>	<b>0 986 435 111</b>	
CDI, CDI 4MATIC [211]	3,0	165	OM 642.920 <D 30>; OM 642.921 <D 30>	04.05-08.09	DBB	6	<b>0 445 115 063</b>	<b>0 986 435 355</b>	
<b>350</b> BlueTec [212]	3,0	155	OM 642.850 <D 30 LHD REPO>	08.09→	DBB	6	<b>0 445 115 059</b>		
CDI [212]	3,0	170	OM 642.850 <D 30 LHD REPO>	08.09-11.10	DBB	6	<b>0 445 116 025</b>		
CDI, CDI 4MATIC [212]	3,0	195	OM 642.852 <D 30 LHD REPO GEST>; OM 642.858 <D 30 LHD REPO>	12.10→	DBB	6	<b>0 445 116 025</b>		
CDI 4MATIC [212]	3,0	170	OM 642.856 <D 30 LHD REPO>	08.09-11.10	DBB	6	<b>0 445 116 025</b>		
<b>Serie G</b>									
<b>270</b> CDI [463]	2,7	115	OM 612.965 <DE LA>						
			Mot.Nr. →30 278709 →60 002079	10.01-08.06	DBB	5	<b>0 445 110 097</b>	<b>0 986 435 039</b>	
			Mot.Nr. 30 278710→ 60 002080→	10.01-08.06	DBB	5	<b>0 445 110 203</b>	<b>0 986 435 065</b>	
<b>320</b> CDI [463]	3,0	165	OM 642.970						
			Mot.Nr. →..40820980	09.06-11.08	DBB	6	<b>0 445 115 063</b>	<b>0 986 435 355</b>	
			Mot.Nr. ...40820981→	12.08→	DBB	6	<b>0 445 115 075</b>		
<b>350</b> BlueTEC [463]	3,0	155	OM 642...						
			Mot.Typ 642.886	07.11→	DBB	6	<b>0 445 115 059</b>		
			Mot.Typ 642.970	07.11→	DBB	6	<b>0 445 115 063</b>	<b>0 986 435 355</b>	
			OM 642.886	07.11→	DBB	6	<b>0 445 115 059</b>		
<b>400</b> CDI [463]	4,0	184	OM 628.962 <DE40LARL>						
			Mot.Nr. →40002970	12.00-08.06	DBB	8	<b>0 445 110 073</b>	<b>0 986 435 031</b>	
			Mot.Nr. 40002971→40016047	12.00-08.06	DBB	8	<b>0 445 110 093</b>	<b>0 986 435 035</b>	
			Mot.Nr. 40016048→40033944	12.00-08.06	DBB	8	<b>0 445 110 103</b>	<b>0 986 435 043</b>	
			Mot.Nr. 40033945→	12.00-08.06	DBB	8	<b>0 445 110 207</b>	<b>0 986 435 069</b>	
<b>Serie GL</b>									
<b>320</b> CDI 4MATIC [164]	3,0	165	OM 642.820 <D 30 LHD REPO>	09.08→	DBB,SCJ	6	<b>0 445 116 025</b>		
					DBB,SCJ	6	<b>0 445 115 059</b>		
			OM 642.940 <D 30>						
			Mot.Nr. →..40820980	02.06-11.08	DBB	6	<b>0 445 115 063</b>	<b>0 986 435 355</b>	
			Mot.Nr. ...40820981→	12.08-04.09	DBB	6	<b>0 445 115 075</b>		
<b>350</b> BlueTec 4MATIC [164]	3,0	155	OM 642.820 <D 30 LHD REPO>	04.09→	DBB	6	<b>0 445 115 059</b>		
CDI 4MATIC [164]	3,0	165	OM 642.940 <D 30>	05.09-08.10	DBB	6	<b>0 445 115 075</b>		
		195	OM 642.822 <D 30 LHD REPO>	09.10→	DBB,SCJ	6	<b>0 445 116 025</b>		
					DBB,SCJ	6	<b>0 445 115 059</b>		
<b>420</b> CDI 4MATIC [164]	4,0	225	OM 629.912 <DE 30 LA>	02.06-04.09	DBB	8	<b>0 445 115 065</b>		
<b>450</b> CDI 4MATIC [164]	4,0	225	OM 629.912 <DE 30 LA>	05.09→	DBB	8	<b>0 445 115 065</b>		
<b>Serie GLK</b>									
<b>320</b> CDI 4MATIC [204]	3,0	165	OM 642.961 <D 30>						
			Mot.Nr. →..40820980	09.08-11.08	DBB	6	<b>0 445 115 063</b>	<b>0 986 435 355</b>	
			Mot.Nr. ...40820981→	12.08→	DBB	6	<b>0 445 115 075</b>		
<b>350</b> CDI 4MATIC [204]	3,0	165-170	OM 642.832 <D 30 LHD REPO>	04.09→	DBB	6	<b>0 445 116 025</b>		
<b>Serie ML</b>									
<b>270</b> CDI [163]	2,7	120	OM 612.963 <DE LA>	11.99-06.05	DBB	5	<b>0 445 110 201</b>	<b>0 986 435 063</b>	





<b>280</b> CDI 4MATIC [164]	3,0	140	OM 642.940 <D 30>							
			Mot.Nr. →..40820980	07.05-11.08	DBB	6	<b>0 445 115 063</b>	<b>0 986 435 355</b>		
			Mot.Nr. ..40820981→	12.08-04.09	<del>DBJ</del>	6	<b>0 445 115 075</b>			
<b>300</b> CDI 4MATIC [164]	3,0	140	OM 642.940 <D 30>	05.09-12.10	DBJ	6	<b>0 445 115 075</b>			
		150	OM 642.820 <D 30 LHD REPO>	05.09→	DBB,SCJ	6	<b>0 445 116 025</b>			
					DBB,SCJ	6	<b>0 445 115 059</b>			
<b>320</b> CDI 4MATIC [164]	3,0	165	OM 642.940 <D 30>	03.05-04.09	DBB	6	<b>0 445 115 063</b>	<b>0 986 435 355</b>		
<b>350</b> BlueTec 4MATIC [164]	3,0	155	OM 642.820 <D 30 LHD REPO>	05.09→	DBB	6	<b>0 445 115 059</b>			
BlueTec 4MATIC [166]	3,0	190	OM 642.826 <D 30 LHD REPO GEST>	06.11→	DBB	6	<b>0 445 116 025</b>			
CDI 4MATIC [164]	3,0	165	OM 642.940 <D 30>	05.09→	DBB	6	<b>0 445 115 063</b>	<b>0 986 435 355</b>		
		170	OM 642.820 <D 30>	02.10→	DBB,SCJ	6	<b>0 445 116 025</b>			
					DBB,SCJ	6	<b>0 445 115 059</b>			
<b>400</b> CDI [163]	4,0	184	OM 628.963 <DE 40 LA LL>							
			Mot.Nr. →40016047	09.01-06.05	DBB	8	<b>0 445 110 093</b>	<b>0 986 435 035</b>		
			Mot.Nr. 40016048→40033944	09.01-06.05	DBB	8	<b>0 445 110 103</b>	<b>0 986 435 043</b>		
			Mot.Nr. 40033945→	09.01-06.05	DBB	8	<b>0 445 110 207</b>	<b>0 986 435 069</b>		
<b>420</b> CDI 4MATIC [164]	4,0	225	OM 629.912 <DE 40 LA>	02.06-04.09	DBB	8	<b>0 445 115 065</b>			
<b>450</b> CDI 4MATIC [164]	4,0	225	OM 629.912 <DE 40 LA>	05.09→	DBB	8	<b>0 445 115 065</b>			
<b>Serie R</b>										
<b>280</b> CDI, CDI 4MATIC [251]	3,0	140	OM 642.950 <D 30>							
			Mot.Nr. →..40820980	04.06-11.08	DBB	6	<b>0 445 115 063</b>	<b>0 986 435 355</b>		
			Mot.Nr. ..40820981→	12.08-04.09	<del>DBJ</del>	6	<b>0 445 115 075</b>			
<b>300</b> CDI [251]	3,0	140	OM 642.87... <D 30>	05.10→	DBB	6	<b>0 445 116 025</b>			
CDI, CDI 4MATIC [251]	3,0	140	OM 642.950 <D 30>	05.09-05.10	<del>DBJ</del>	6	<b>0 445 115 075</b>			
<b>320</b> CDI 4MATIC [251]	3,0	165	OM 642.950 <D 30>	09.05-04.09	DBB	6	<b>0 445 115 063</b>	<b>0 986 435 355</b>		
			Mot.Nr. →..40820980	06.07-11.08	DBB	6	<b>0 445 115 063</b>	<b>0 986 435 355</b>		
			Mot.Nr. ..40820981→	12.08-05.09	<del>DBJ</del>	6	<b>0 445 115 075</b>			
<b>350</b> BlueTec 4MATIC [251]	3,0	155	OM 642.870 <D 30 LHD REPO>	05.09→	DBB	6	<b>0 445 115 059</b>			
CDI 4MATIC [251]	3,0	195	OM 642.872 <D 30>	05.10→	DBB	6	<b>0 445 116 025</b>			
<b>Serie S</b>										
<b>320</b> CDI [220]	3,2	145	OM 613.960 <DE 32 LA>	06.99-08.02	DBB	6	<b>0 445 110 095</b>	<b>0 986 435 037</b>		
		150	OM 648.960 <DE 32 LA>	09.02-02.04	DBB	6	<b>0 445 110 155</b>	<b>0 986 435 135</b>		
				03.04-08.05	DBB	6	<b>0 445 110 176</b>	<b>0 986 435 111</b>		
CDI, CDI 4MATIC [221]	3,0	173	OM 642.930 <D 30>							
			Mot.Nr. →40820980	12.05-11.08	DBB	6	<b>0 445 115 063</b>	<b>0 986 435 355</b>		
			Mot.Nr. ..40820981→	12.08-04.09	<del>DBJ</del>	6	<b>0 445 115 075</b>			
<b>350</b> BlueTEC, BlueTEC 4MATIC [221]	3,0	190	OM 642.862 <D 30 LHD>; OM 642.868 <D 30 LHD>	07.10→	DBB	6	<b>0 445 116 025</b>			
CDI, CDI 4MATIC [221]	3,0	173	OM 642.930 <D 30>; OM 642.932 <D 30>	05.09-06.10	<del>DBJ</del>	6	<b>0 445 115 075</b>			
<b>400</b> CDI [220]	4,0	184/191	OM 628.960 <DE 40 LA>							
			Mot.Nr. →40002970	06.99-08.05	DBB	8	<b>0 445 110 073</b>	<b>0 986 435 031</b>		
			Mot.Nr. 40002971→40019316	06.99-08.05	DBB	8	<b>0 445 110 093</b>	<b>0 986 435 035</b>		
			Mot.Nr. 40019317→40033944	06.99-08.05	DBB	8	<b>0 445 110 103</b>	<b>0 986 435 043</b>		
			Mot.Nr. 40033945→	06.99-08.05	DBB	8	<b>0 445 110 207</b>	<b>0 986 435 069</b>		
<b>420</b> CDI [221]	4,0	235	OM 629.911 <DE 40 LA>	12.06-04.09	DBB	8	<b>0 445 115 065</b>			
<b>450</b> CDI [221]	4,0	235	OM 629.911 <DE 40 LA>	05.09-06.10	DBB	8	<b>0 445 115 065</b>			
<b>Serie V</b>										
<b>200</b> CDI [638 TON]	2,2	75	OM 611.980							
			Mot.Nr. →..220722	06.99-09.03	DBB,EU3	4	<b>0 445 110 105</b>	<b>0 986 435 045</b>		
					DBB,EU3	4	<b>0 445 110 011</b>	<b>0 986 435 004</b>		
			Mot.Nr. ..220723→	06.99-09.03	DBB,EU3	4	<b>0 445 110 181</b>	<b>0 986 435 053</b>		
					DBB,EU3	4	<b>0 445 110 201</b>	<b>0 986 435 063</b>		
<b>220</b> CDI [638 TON]	2,2	90	OM 611.980							
			Mot.Nr. →..220722	06.99-09.03	DBB,EU3	4	<b>0 445 110 105</b>	<b>0 986 435 045</b>		
					DBB,EU3	4	<b>0 445 110 011</b>	<b>0 986 435 004</b>		
			Mot.Nr. ..220723→	06.99-09.03	DBB,EU3	4	<b>0 445 110 181</b>	<b>0 986 435 053</b>		
					DBB,EU3	4	<b>0 445 110 201</b>	<b>0 986 435 063</b>		
<b>Vaneo</b>										
<b>1.7</b> CDI [414]	1,7	55/67	OM 668.914 <DE 17 LA>							
			Mot.Nr. →30368491	02.02-08.05	DBB	4	<b>0 445 110 089</b>	<b>0 986 435 033</b>		
			Mot.Nr. 30368942→	02.02-08.05	DBB	4	<b>0 445 110 197</b>	<b>0 986 435 059</b>		





◀ MERCEDES-BENZ

Viano									
2.0 CDI [639 TON]	2,1	80	OM 646.982 <OM 646 DE22LA (MOC2)>	09.03-10.06	DBB,EU4	4	0 445 110 191	0 986 435 113	
								0 986 435 114	
								Mot.Nr. →50202886	09.03-10.06
			Mot.Nr. 50202887→	09.03-10.06	DBB,EU3	4	0 445 110 263	0 986 435 115	
2.2 CDI [639 TON]	2,1	110	OM 646.982 <OM 646 DE22LA>	11.06-08.10	DBB	4	0 445 115 068	0 986 435 356	
								0 986 435 114	
								Mot.Nr. →50202886	09.03-08.10
			Mot.Nr. 50202887→	09.03-08.10	DBB,EU3	4	0 445 110 263	0 986 435 115	
3.0 CDI [639 TON]	3,0	150	OM 642.990 <OM 642 DE 30LA>	04.06-11.08	DBB	6	0 445 115 063	0 986 435 355	
								0 986 435 114	
								Mot.Nr. →40820980	12.08-08.10
			Mot.Nr. ...40820981→	07.10→	DBJ	6	0 445 115 075		
		165	OM 642.990 <OM 642 DE 30LA>	07.10→	DBJ	6	0 445 115 075		

**MG**

ZT									
135 2.0 CDTi	2,0	96	20 4D 2 <M47R>	10.02-05.05	DBJ	4	0 445 110 030	0 986 435 011	
190 2.0 CDT	2,0	85	20 4D 2 <M47R>	10.01-05.05	DBJ	4	0 445 110 030	0 986 435 011	
ZT-Tourer									
135 2.0 CDTi	2,0	96	20 4D 2 <M47R>	10.02-05.05	DBJ	4	0 445 110 030	0 986 435 011	
190 2.0 CDT	2,0	85	20 4D 2 <M47R>	10.01-05.05	DBJ	4	0 445 110 030	0 986 435 011	

**MINI (BMW)**

Mini									
Cooper D [R 56]	1,6	82	N47 C16A	09.10→	DBJ	4	0 445 110 401		
D, SD [R 56]	2,0	82/105	N47 C20A	03.11→	DBJ	4	0 445 110 289		
One D [R 56]	1,6	66	N47 C16A	09.10→	DBJ	4	0 445 110 401		
Mini Cabrio									
Cooper D [R 57]	1,6	82	N47 C16A	09.10→	DBJ	4	0 445 110 401		
D, SD [R 57]	2,0	82/105	N47 C20A	03.11→	DBJ	4	0 445 110 289		
Mini Clubman									
Cooper D [R 55]	1,6	82	N47 C16A	09.10→	DBJ	4	0 445 110 401		
D, SD [R 55]	2,0	82/105	N47 C20A	03.11→	DBJ	4	0 445 110 289		
One D [R 55]	1,6	66	N47 C16A	09.10→	DBJ	4	0 445 110 401		
Mini Countryman									
Cooper D, D ALL4 [R 60]	1,6	82	N47 C16A	09.10→	DBJ	4	0 445 110 401		
D, D ALL4, SD, SD ALL4 [R 60]	2,0	82/105	N47 C20A	03.11→	DBJ	4	0 445 110 289		
One D [R 60]	1,6	66	N47 C16A	09.10→	DBJ	4	0 445 110 401		
Mini Coupé									
Cooper SD [R 58]	2,0	105	N47 C20A	09.11→	DBJ	4	0 445 110 289		

**NISSAN**

Qashqai									
2.0 dCi, dCi 4x4 [J10]	2,0	110	M9R	04.07→	DBJ,EU5	4	0 445 115 022		
Qashqai+2									
2.0 dCi, dCi 4x4 [JJ10]	2,0	110	M9R	08.08→	DBJ,EU5	4	0 445 115 022		
X-Trail									
2.0 dCi [T31]	2,0	110	M9R	04.07-06.10	DBJ	4	0 445 115 022		
dCi 4x4 [T31]	2,0	110	M9R	04.07-06.10	DBJ	4	0 445 115 022		
				RUS 07.10→	DBJ	4	0 445 115 022		







OPEL

Agila									
1.3 CDTI [A]	1,3	51	Z 13 DT <Turbo>	08.03-02.08	DBB	4	0 445 110 083	0 986 435 078	
CDTI [B]	1,2	55	Z 13 DTJ	07.08→	DBB	4	0 445 110 183	0 986 435 102	
Antara									
2.0 CDTI, CDTI 4x4	2,0	93/110	Z 20 DM <Ecotec>; Z 20 DMH; Z 20 DMH <Ecotec>	05.06→	DBJ	4	0 445 110 269	0 986 435 153	
Astra									
1.3 CDTI [H]	1,3	66	Z 13 DTH <Ecotec>	08.05-03.10	DBB	4	0 445 110 183	0 986 435 102	
1.7 CDTI [G]	1,7	59	Z 17 DTL <Turbo>	03.03-01.04	<del>DBJ</del>	4	0 445 110 118	0 986 435 082	
CDTI [H]	1,7	59	Z 17 DTL <Turbo Ecotec>	03.04-09.05	<del>DBJ</del>	4	0 445 110 174	0 986 435 105	
		74	Z 17 DTH <Turbo Ecotec>	03.04-03.07	<del>DBJ</del>	4	0 445 110 175	0 986 435 089	
1.9 CDTI [H]	1,9	74	Z 19 DTL <Turbo Ecotec>	10.05-09.09	DBB,TW	4	0 445 110 165	0 986 435 103	
						4	0 445 110 276	0 986 435 148	
		88	Z 19 DT <Turbo Ecotec>						
			Fg.Nr. →72045139→75030986 →78025126	09.04-03.10	DBB	4	0 445 110 165	0 986 435 103	
			Fg.Nr. 72045140→75030987→ 78025127→78007392→	09.04-03.10	DBB	4	0 445 110 276	0 986 435 148	
			Z 19 DTJ <Turbo Ecotec>						
			Fg.Nr. →72045139→75030986 →78025126	04.04-03.10	DBB	4	0 445 110 159	0 986 435 088	
			Fg.Nr. 72045140→75030987→ 78025127→	04.04-03.10	DBB	4	0 445 110 243	0 986 435 104	
		110	Z 19 DTH <Turbo Ecotec>						
			Fg.Nr. →72045139→75030986 →78025126	04.04-03.10	DBB	4	0 445 110 159	0 986 435 088	
			Fg.Nr. 72045140→75030987→ 78025127→	04.04-03.10	DBB	4	0 445 110 243	0 986 435 104	
2.0 CDTI [J]	2,0	118/121	A 20 DTH <Ecotec>	09.09→	DBB	4	0 445 110 327		
Astra Cabrio									
1.7 CDTI [G]	1,7	59	Z 17 DTL <Turbo>	03.03-08.05	<del>DBJ</del>	4	0 445 110 118	0 986 435 082	
Astra Caravan									
1.3 CDTI [H]	1,3	66	Z 13 DTH <Ecotec>	08.05-03.10	DBB	4	0 445 110 183	0 986 435 102	
1.7 CDTI [G]	1,7	59	Z 17 DTL <Turbo>	03.03-06.04	<del>DBJ</del>	4	0 445 110 118	0 986 435 082	
CDTI [H]	1,7	59	Z 17 DTL <Turbo Ecotec>	08.04-09.05	<del>DBJ</del>	4	0 445 110 174	0 986 435 105	
		74	Z 17 DTH <Turbo Ecotec>	08.04-03.07	<del>DBJ</del>	4	0 445 110 175	0 986 435 089	
1.9 CDTI [H]	1,9	74	Z 19 DTL <Turbo Ecotec>	09.05-07.10	DBB,TW	4	0 445 110 165	0 986 435 103	
						4	0 445 110 276	0 986 435 148	
		88	Z 19 DT <Turbo Ecotec>						
			Fg.Nr. →72045139→75030986 →78025126	09.05-03.10	DBB	4	0 445 110 165	0 986 435 103	
			Fg.Nr. 72045140→75030987→ 78025127→78007392→	09.05-03.10	DBB	4	0 445 110 276	0 986 435 148	
			Z 19 DTJ <Turbo Ecotec>						
			Fg.Nr. →72045139→75030986 →78025126	09.04-03.10	DBB	4	0 445 110 159	0 986 435 088	
			Fg.Nr. 72045140→75030987→ 78025127→	09.04-03.10	DBB	4	0 445 110 243	0 986 435 104	
		110	Z 19 DTH <Turbo Ecotec>						
			Fg.Nr. →72045139→75030986 →78025126	09.04-03.10	DBB	4	0 445 110 159	0 986 435 088	
			Fg.Nr. 72045140→75030987→ 78025127→	09.04-03.10	DBB	4	0 445 110 243	0 986 435 104	
Astra Coupé									
1.7 CDTI [G]	1,7	59	Z 17 DTL <Turbo>	03.03-02.05	<del>DBJ</del>	4	0 445 110 118	0 986 435 082	
Astra GTC									
1.3 CDTI [H]	1,3	66	Z 13 DTH <Ecotec>	06.05-02.09	DBB	4	0 445 110 183	0 986 435 102	
1.7 CDTI [H]	1,7	59	Z 17 DTL <Turbo Ecotec>	03.05-03.07	<del>DBJ</del>	4	0 445 110 174	0 986 435 105	
		74	Z 17 DTH <Turbo Ecotec>	09.05-03.07	<del>DBJ</del>	4	0 445 110 175	0 986 435 089	





◀ OPEL

<b>1.9 [H]</b>	1,9	74	Z 19 DTL <Turbo Ecotec>	07.05-07.10	DBB,TW	4	<b>0 445 110 165</b>	<b>0 986 435 103</b>
						4	<b>0 445 110 276</b>	<b>0 986 435 148</b>
		88	Z 19 DT <Turbo Ecotec>	07.05-07.10	DBB,TW	4	<b>0 445 110 165</b>	<b>0 986 435 103</b>
						4	<b>0 445 110 276</b>	<b>0 986 435 148</b>
<b>CDTI [H]</b>	1,9	88	Z 19 DTJ <Turbo Ecotec>					
			Fg.Nr. →72045139 →75030986 →78025126	03.05-03.08	DBB	4	<b>0 445 110 159</b>	<b>0 986 435 088</b>
			Fg.Nr. 72045140 → 75030987 → 78025127 →	03.05-03.08	DBB	4	<b>0 445 110 243</b>	<b>0 986 435 104</b>
		110	Z 19 DTH <Turbo Ecotec>					
			Fg.Nr. →72045139 →75030986 →78025126	03.05-09.09	DBB	4	<b>0 445 110 159</b>	<b>0 986 435 088</b>
			Fg.Nr. 72045140 → 75030987 → 78025127 →	03.05-09.09	DBB	4	<b>0 445 110 243</b>	<b>0 986 435 104</b>
<b>2.0 [J]</b>	2,0	121	A 20 DTH <ecoFlex>	09.11 →	DBB	4	<b>0 445 110 327</b>	
<b>Astra Sports Tourer</b>								
<b>2.0 CDTI [J]</b>	2,0	118/121	A 20 DTH <Ecotec>	09.10 →	DBB	4	<b>0 445 110 327</b>	
<b>Astra TwinTop</b>								
<b>1.9 CDTI [H]</b>	1,9	110	Z 19 DTH <Ecotec>	09.05 →	DBB,TW	4	<b>0 445 110 159</b>	<b>0 986 435 088</b>
						4	<b>0 445 110 243</b>	<b>0 986 435 104</b>
<b>Combo</b>								
<b>1.3 CDTI [Tour]</b>	1,3	51/55	Y 13 DT <Ecotec>; Z 13 DT <Ecotec>; Z 13 DTJ <Ecotec>	09.04 →	DBB	4	<b>0 445 110 083</b>	<b>0 986 435 078</b>
<b>Corsa</b>								
<b>1.3 CDTI [C]</b>	1,3	51	Y 13 DT <Ecotec>; Z 13 DT <Ecotec>	09.03-09.06	DBB	4	<b>0 445 110 083</b>	<b>0 986 435 078</b>
		55	Z 13 DTJ <Ecotec>	09.05-09.06	DBB	4	<b>0 445 110 183</b>	<b>0 986 435 102</b>
<b>CDTI [D]</b>	1,2	55/66	A 13 DTH <Ecotec>; Z 13 DTH <Ecotec>; Z 13 DTJ <Ecotec>	07.06 →	DBB	4	<b>0 445 110 183</b>	<b>0 986 435 102</b>
<b>Insignia</b>								
<b>2.0 CDTI [68]</b>	2,0	96	A 20 D... <ecoFlex>					
			Mot. Typ DT	09.08 →	<del>DBJ</del>	4	<b>0 445 110 423</b>	
			Mot. Typ DTJ	09.08 →	DBB	4	<b>0 445 110 327</b>	
<b>CDTI [69]</b>	2,0	96	A 20 D... <ecoFlex>					
			Mot. Typ DT	09.08 →	<del>DBJ</del>	4	<b>0 445 110 423</b>	
			Mot. Typ DTJ	09.08 →	DBB	4	<b>0 445 110 327</b>	
<b>CDTI, CDTI 4x4 [68]</b>	2,0	81/118	A 20 DT... <Ecotec>; A 20 DTH <ecoFlex>; A 20 DTH <Ecotec>	09.08 →	DBB	4	<b>0 445 110 327</b>	
<b>CDTI, CDTI 4x4 [69]</b>	2,0	81/118	A 20 DT... <Ecotec>; A 20 DTH <ecoFlex>; A 20 DTH <Ecotec>	09.08 →	DBB	4	<b>0 445 110 327</b>	
<b>Insignia Sports Tourer</b>								
<b>2.0 CDTI [35]</b>	2,0	96	A 20 D... <ecoFlex>					
			Mot. Typ DT	02.09 →	<del>DBJ</del>	4	<b>0 445 110 423</b>	
			Mot. Typ DTJ	02.09 →	DBB	4	<b>0 445 110 327</b>	
<b>CDTI, CDTI 4x4 [35]</b>	2,0	81/118	A 20 DT... <Ecotec>; A 20 DTH <ecoFlex>; A 20 DTH <Ecotec>	02.09 →	DBB	4	<b>0 445 110 327</b>	
<b>Meriva</b>								
<b>1.3 CDTI [A]</b>	1,3	55	Y 13 DT <Ecotec>; Z 13 DT <Ecotec>	04.05-03.10	DBB	4	<b>0 445 110 083</b>	<b>0 986 435 078</b>
			Z 13 DTJ <Ecotec>	09.03-03.10	DBB	4	<b>0 445 110 183</b>	<b>0 986 435 102</b>
<b>Signum</b>								
<b>1.9 CDTI</b>	1,9	74	Z 19 DTL <Ecotec>					
			Fg.Nr. →71021891	08.05-09.08	DBB	4	<b>0 445 110 165</b>	<b>0 986 435 103</b>
			Fg.Nr. 71021892 →	08.05-09.08	DBB	4	<b>0 445 110 276</b>	<b>0 986 435 148</b>
		88	Z 19 DT <Ecotec>					
			Fg.Nr. →71021891	04.04-09.08	DBB	4	<b>0 445 110 165</b>	<b>0 986 435 103</b>
			Fg.Nr. 71021892 →	04.04-09.08	DBB	4	<b>0 445 110 276</b>	<b>0 986 435 148</b>
		110	Z 19 DTH <Ecotec>					
			Fg.Nr. →71021891	04.04-09.08	DBB	4	<b>0 445 110 159</b>	<b>0 986 435 088</b>
			Fg.Nr. 71021892 →	04.04-09.08	DBB	4	<b>0 445 110 243</b>	<b>0 986 435 104</b>
<b>Tigra TwinTop</b>								
<b>1.3 CDTI [B]</b>	1,3	51	Z 13 DT <Turbo Ecotec>	06.04-03.09	DBB	4	<b>0 445 110 083</b>	<b>0 986 435 078</b>



Vectra									
1.9 CDTi, CDTi GTS [C]	1,9	74	Z 19 DTL <Ecotec>						
			Fg.Nr. →71021891 →48999999	09.05-10.08	DBB	4	0 445 110 165	0 986 435 103	
				Fg.Nr. 71021892→	09.05-10.08	DBB	4	0 445 110 276	0 986 435 148
	88	Z 19 DT <Ecotec>							
		Fg.Nr. →71021891 →48999999	04.04-10.08	DBB	4	0 445 110 165	0 986 435 103		
				Fg.Nr. 71021892→	04.04-10.08	DBB	4	0 445 110 276	0 986 435 148
110	Z 19 DTH <Ecotec>								
	Fg.Nr. →71021891 →48999999	04.04-03.08	DBB	4	0 445 110 159	0 986 435 088			
			Fg.Nr. 71021892→	04.04-03.08	DBB	4	0 445 110 243	0 986 435 104	

Vectra Caravan									
1.9 CDTi [C]	1,9	74	Z 19 DTL <Ecotec>						
			Fg.Nr. →71021891 →48999999	09.05-10.08	DBB	4	0 445 110 165	0 986 435 103	
				Fg.Nr. 71021892→	09.05-10.08	DBB	4	0 445 110 276	0 986 435 148
	88	Z 19 DT <Ecotec>							
		Fg.Nr. →71021891 →48999999	04.04-10.08	DBB	4	0 445 110 165	0 986 435 103		
				Fg.Nr. 71021892→	04.04-10.08	DBB	4	0 445 110 276	0 986 435 148
110	Z 19 DTH <Ecotec>								
	Fg.Nr. →71021891 →48999999	04.04-03.08	DBB	4	0 445 110 159	0 986 435 088			
			Fg.Nr. 71021892→	04.04-03.08	DBB	4	0 445 110 243	0 986 435 104	

Zafira									
1.9 CDTi [B]	1,9	74	Z 19 DTL <Ecotec>						
			Fg.Nr. →62999999 →6G999999	07.05-03.08	DBB	4	0 445 110 165	0 986 435 103	
				Fg.Nr. 72000001→7G000001→	07.05-03.08	DBB	4	0 445 110 276	0 986 435 148
	88	Z 19 DT <Ecotec>							
		Fg.Nr. →62999999 →6G999999	07.05→	DBB	4	0 445 110 165	0 986 435 103		
				Fg.Nr. 72000001→7G000001→	07.05→	DBB	4	0 445 110 276	0 986 435 148
110	Z 19 DTH <Ecotec>								
	Fg.Nr. →62999999 →6G999999	07.05→	DBB	4	0 445 110 159	0 986 435 088			
			Fg.Nr. 72000001→7G000001→	07.05→	DBB	4	0 445 110 243	0 986 435 104	

PEUGEOT

Bipper									
1.4 HDi [A9]	1,4	50	8HS <DV4TED>		02.08→	DBJ	4	0 445 110 252	0 986 435 143
Expert									
1.6 HDi [G9]	1,6	66	9HM <DV6U C>		12.10→	DBJ	4	0 445 110 340	
			9HU <DV6UTED4>		02.07→	DBJ	4	0 445 110 239	0 986 435 122
2.0 HDi [U64]	2,0	70	RHX <DW10BTED>						
			Org.Nr. →8763	10.99-11.00	DBB,I2G	4	0 445 110 044	0 986 435 003	
					<del>DBB,I1B</del>	4	0 445 110 008	0 986 435 003	
			Org.Nr. 8764→	12.00-01.07	DBB	4	0 445 110 076	0 986 435 077	
		80	RHZ <DW10ATED>		10.99-01.07	DBB,I2G	4	0 445 110 044	0 986 435 003
						<del>DBB,I1B</del>	4	0 445 110 008	0 986 435 003
		81	RHW <DW10ATED4/L4>		06.00-01.07	DBB	4	0 445 110 057	0 986 435 093
Partner									
1.6 HDi [B9]	1,6	55/66	9HT <DV6B/DV6BUTED4>; 9HX <DV6ATED4/DV6AUTED4>		05.08→	DBJ	4	0 445 110 311	0 986 435 146
			55/66/68 9HF <DV6DTED>; 9HJ <DV6DTED M>; 9HK <DV6ETED M>; 9HN <DV6ETED4>; 9HP <DV6DTED>		07.10→	DBJ	4	0 445 110 340	
		66	9HS <DV6TED4BU/FAP>; 9HV <DV6TED4/FAP>		10.08→	DBJ	4	0 445 110 297	0 986 435 150
		80	9HZ <DV6TED4 FAP>		05.08→	DBJ	4	0 445 110 297	0 986 435 150
Hdi [M5]	1,6	55/66	9HW <DV6BTED4>; 9HX <DV6ATED4>		09.05-04.08	DBJ	4	0 445 110 239	0 986 435 122
2.0 HDi [M4]	2,0	66	RHY <DW10TD>						
			Org.Nr. →8728	12.99-10.00	BO,DBB, I2G	4	0 445 110 044	0 986 435 003	
					BO, <del>DBB</del> , I1B	4	0 445 110 008	0 986 435 003	
			Org.Nr. 8729→	11.00-08.02	BO,DBB	4	0 445 110 076	0 986 435 077	
HDI	2,0	66	DW10TD		10.00→	DBB	4	0 445 110 044	0 986 435 003





◀ PEUGEOT

206										
1.4 HDi [T1]	1,4	50	8H... <DV4TD>							
			Mot.Nr. →232614	09.01-02.09	DBJ	4	0 445 110 075	0 986 435 076		
			Mot.Nr. 232615→	09.01-12.05	DBB	4	0 445 110 135	0 986 435 085		
			Org.Nr. 10618							
			Org.Nr. 10619→	01.06-02.09	DBJ	4	0 445 110 252	0 986 435 143		
1.6 HDi [T1]	1,6	80	9H... <DV6TED4>	05.04-03.07	DBJ,MPR	4	0 445 110 297	0 986 435 150		
			Org.Nr. →10338	05.04-03.05	DBJ,MPR	4	0 445 110 188	0 986 435 090		
			Org.Nr. 10339→	04.05-03.07	DBJ,MPR	4	0 445 110 259	0 986 435 126		
2.0 HDi [T1]	2,0	66	RHY <DW10TD>							
			Org.Nr. →8700	04.99-09.00	DBB,I2G	4	0 445 110 044	0 986 435 003		
					DBB,I1B	4	0 445 110 008	0 986 435 003		
			Org.Nr. 8701→	10.00-10.05	DBB	4	0 445 110 076	0 986 435 077		
206+										
1.4 HDi [T3E]	1,4	50	8HR <DV4C>	06.10→	DBJ	4	0 445 110 339			
			8HZ <DV4TD>	03.09→	DBJ	4	0 445 110 252	0 986 435 143		
206 CC										
1.6 HDi [T1]	1,6	80	9H... <DV6TED4>	06.05-03.07	DBJ,MPR	4	0 445 110 297	0 986 435 150		
					DBJ,MPR	4	0 445 110 259	0 986 435 126		
206 Sedan										
1.4 HDi 16V [T1]	1,4	50	8H... <DV4TD>	09.08-12.10	DBB,EE2	4	0 445 110 135	0 986 435 085		
					DBJ,FL5	4	0 445 110 252	0 986 435 143		
206 SW										
1.4 HDi [T1]	1,4	50	8HX <DV4TD>							
			Mot.Nr. →232614	03.02-12.06	DBJ	4	0 445 110 075	0 986 435 076		
			Mot.Nr. 232615→	03.02-12.06	DBB	4	0 445 110 135	0 986 435 085		
1.6 HDi [T1]	1,6	80	9H... <DV6TED4>	05.04-12.06	DBJ,MPR	4	0 445 110 297	0 986 435 150		
			Org.Nr. →10338	05.04-03.05	DBJ,MPR	4	0 445 110 188	0 986 435 090		
			Org.Nr. 10339→	04.05-12.06	DBJ,MPR	4	0 445 110 259	0 986 435 126		
2.0 HDi [T1]	2,0	66	RHY <DW10TD>	03.02-10.05	DBB	4	0 445 110 076	0 986 435 077		
207										
1.4 HDi [A7]	1,4	50	8HR <DV4C>	05.10→	DBJ	4	0 445 110 339			
			8HZ <DV4TD>	05.06-04.10	DBJ	4	0 445 110 252	0 986 435 143		
1.6 HDi [A7]	1,6	66	9HV <DV6TED4/FAP>	06.07-04.11	DBJ	4	0 445 110 297	0 986 435 150		
			9HX <DV6ATED4>							
			Org.Nr. →11073	05.06-03.07	DBJ	4	0 445 110 239	0 986 435 122		
			Org.Nr. 11074→	04.07-04.11	DBJ	4	0 445 110 311	0 986 435 146		
		68	9HP <DV6DTED>	04.10→	DBJ	4	0 445 110 340			
		80	9H... <DV6TED4>	05.06-04.10	DBJ,MPR	4	0 445 110 297	0 986 435 150		
			Org.Nr. →11073	05.06-03.07	DBJ,MPR	4	0 445 110 259	0 986 435 126		
			Org.Nr. 11074→	04.07-04.10	DBJ,MPR	4	0 445 110 297	0 986 435 150		
207 CC										
1.6 HDi [A7]	1,6	80	9HZ <DV6TED4>							
			Org.Nr. →11073	03.07-03.07	DBJ	4	0 445 110 259	0 986 435 126		
			Org.Nr. 11074→	04.07-02.11	DBJ	4	0 445 110 297	0 986 435 150		
207 SW										
1.6 HDi [A7]	1,6	66	9HX <DV6ATED4>	06.07-04.11	DBJ	4	0 445 110 311	0 986 435 146		
		66/80	9H... <DV6TED4>; 9HV <DV6TED4/FAP>	06.07-04.11	DBJ	4	0 445 110 297	0 986 435 150		
		68	9HP <DV6DTED>	04.10→	DBJ	4	0 445 110 340			
306										
2.0 HDi [N5]	2,0	66	RHY <DW10TD>							
			Org.Nr. →8756	06.99-05.00	DBB,I2G	4	0 445 110 044	0 986 435 003		
					DBB,I1B	4	0 445 110 008	0 986 435 003		
			Org.Nr. 8757→	06.00-10.03	DBB	4	0 445 110 076	0 986 435 077		
HDI	2,0	66	<DW10TD>	12.00→	DBB	4	0 445 110 044	0 986 435 003		
306 Break										
2.0 HDi [N5]	2,0	66	RHY <DW10TD>							
			Org.Nr. →8756	06.99-05.00	DBB,I2G	4	0 445 110 044	0 986 435 003		
					DBB,I1B	4	0 445 110 008	0 986 435 003		
			Org.Nr. 8757→	06.00-03.02	DBB	4	0 445 110 076	0 986 435 077		





307										
1.4 HDi [T5]	1,4	50	8HZ <DV4TD>	Mot.Nr. →236724	10.01-05.05	DBJ	4	0 445 110 075	0 986 435 076	
				Mot.Nr. 236725→	10.01-05.05	DBB	4	0 445 110 135	0 986 435 085	
1.6 HDi [T5]	1,6	80	9H... <DV6TED4>	Org.Nr. →10373	02.04-04.05	DBJ	4	0 445 110 188	0 986 435 090	
				Org.Nr. 10374→	05.05-05.05	DBJ	4	0 445 110 259	0 986 435 126	
HDi [T6]	1,6	66	9HV <DV6TED4/FAP>	Org.Nr. →11192	06.05-07.07	DBJ	4	0 445 110 239	0 986 435 122	
				Org.Nr. 11193→	08.07-08.07	DBJ	4	0 445 110 311	0 986 435 146	
			80	9H... <DV6TED4>	Org.Nr. →10919	06.05-10.06	DBJ	4	0 445 110 259	0 986 435 126
					Org.Nr. 10920→	11.06-08.07	DBJ	4	0 445 110 297	0 986 435 150
2.0 HDi [T5]	2,0	66	RHY <DW10TD>	Org.Nr. →9064	08.00-09.01	BO,DBJ	4	0 445 110 062	0 986 435 077	
				Org.Nr. 9065→	10.01-05.05	BO,DBB	4	0 445 110 076	0 986 435 077	
			79	RHS <DW10ATED/FAP>	03.02-05.05	DBB	4	0 445 110 076	0 986 435 077	

307 Break/SW										
1.4 HDi [T5]	1,4	50	8HZ <DV4TD>	Mot.Nr. →236724	03.02-05.05	DBJ	4	0 445 110 075	0 986 435 076	
				Mot.Nr. 236725→	03.02-05.05	DBB	4	0 445 110 135	0 986 435 085	
1.6 HDi [T5]	1,6	80	9H... <DV6TED4>	Org.Nr. →10373	02.04-04.05	DBJ	4	0 445 110 188	0 986 435 090	
				Org.Nr. 10374→	05.05-05.05	DBJ	4	0 445 110 259	0 986 435 126	
HDi [T6]	1,6	66	9HV <DV6TED4/FAP>	Org.Nr. →11192	06.05-07.07	DBJ	4	0 445 110 239	0 986 435 122	
				Org.Nr. 11193→	08.07-05.08	DBJ	4	0 445 110 311	0 986 435 146	
			80	9H... <DV6TED4>	Org.Nr. →10919	06.05-10.06	DBJ	4	0 445 110 259	0 986 435 126
					Org.Nr. 10920→	11.06-05.08	DBJ	4	0 445 110 297	0 986 435 150
2.0 HDi [T5]	2,0	66	RHY <DW10TD>	03.02-05.05	BO,DBB	4	0 445 110 076	0 986 435 077		
		79	RHS <DW10ATED/FAP>	03.02-05.05	DBB	4	0 445 110 076	0 986 435 077		

308									
1.6 HDi [T7]	1,6	66	9HX <DV6ATED4>	09.07→	DBJ	4	0 445 110 311	0 986 435 146	
			66/80	9HV <DV6TED4/FAP>; 9HZ <DV6TED4/FAP>	09.07→	DBJ	4	0 445 110 297	0 986 435 150
			68	9HJ <DV6DTED M>; 9HP <DV6DTED>	04.10→	DBJ	4	0 445 110 340	

308 SW									
1.6 HDi [T7]	1,6	66	9HV <DV6TED4/FAP>	05.08→	DBJ	4	0 445 110 297	0 986 435 150	
			9HX <DV6ATED4>	05.08→	DBJ	4	0 445 110 311	0 986 435 146	
		68	9HJ <DV6DTED M>; 9HP <DV6DTED>	06.10→	DBJ	4	0 445 110 340		
				80	9H... <DV6TED4>	05.08→	DBJ,EU3	4	0 445 110 259
					DBJ,EU4	4	0 445 110 297	0 986 435 150	

406									
2.0 HDi [D8]	2,0	80	RHZ <DW10ATED>	10.98-03.99	DBJ	4	0 445 110 008	0 986 435 003	
HDi [D9]	2,0	66	RHY <DW10TD>	04.99-06.04	BO,DBB,	4	0 445 110 044	0 986 435 003	
					I2G				
					BO,DBB,	4	0 445 110 076	0 986 435 077	
				KKX,KKY					
				BO,DBJ,	4	0 445 110 008	0 986 435 003		
				I1B					
	79/80	RHS <DW10ATED/FAP>; RHZ <DW10ATED>	04.99-06.04	DBB,I2G	4	0 445 110 044	0 986 435 003		
				DBB,KKX,	4	0 445 110 076	0 986 435 077		
				KKY,KKZ					
				DBJ,I1B	4	0 445 110 008	0 986 435 003		
2.2 HDi [D9]	2,2	98	4HX <DW12TED4>	03.00-06.04	DBB	4	0 445 110 036	0 986 435 013	
								0 986 435 014	
								0 986 435 015	





◀ PEUGEOT

406 Break									
2.0 HDi [D8]	2,0	80	RHZ <DW10ATED>	10.98-03.99	<del>DBJ</del>	4	0 445 110 008	0 986 435 003	
HDi [D9]	2,0	66	RHY <DW10TD>	04.99-06.04	BO, DBB, I2G	4	0 445 110 044	0 986 435 003	
					BO, DBB, KXX, KKY	4	0 445 110 076	0 986 435 077	
					BO, <del>DBJ</del> , I1B	4	0 445 110 008	0 986 435 003	
		79/80	RHS <DW10ATED/FAP>; RHZ <DW10ATED>	04.99-06.04	DBB, I2G	4	0 445 110 044	0 986 435 003	
					DBB, KXX, KKY, KKZ	4	0 445 110 076	0 986 435 077	
					<del>DBJ</del> , I1B	4	0 445 110 008	0 986 435 003	
2.2 HDi [D9]	2,2	98	4HX <DW12TED4>	03.00-06.04	DBB	4	0 445 110 036	0 986 435 013	0 986 435 014 0 986 435 015
406 Coupé									
2.2 HDi [D9]	2,2	98	4HX <DW12TED4>	03.00-02.05	DBB	4	0 445 110 036	0 986 435 013	0 986 435 014 0 986 435 015
407									
1.6 HDi [D2]	1,6	80	9H... <DV6TED4>						
			Org.Nr. →10373	05.04-04.05	DBJ	4	0 445 110 188	0 986 435 090	
			Org.Nr. 10374→11073	05.05-03.07	DBJ	4	0 445 110 259	0 986 435 126	
			Org.Nr. 11074→	04.07→	DBJ	4	0 445 110 297	0 986 435 150	
2.2 HDi [D2]	2,2	125	4H... <DW12BTED4>	05.06→	DBB	4	0 445 115 025	0 986 435 351	
407 SW									
1.6 HDi [D2]	1,6	80	9H... <DV6TED4>						
			Org.Nr. →10373	05.04-04.05	DBJ	4	0 445 110 188	0 986 435 090	
			Org.Nr. 10374→11073	05.05-03.07	DBJ	4	0 445 110 259	0 986 435 126	
			Org.Nr. 11074→	04.07→	DBJ	4	0 445 110 297	0 986 435 150	
2.2 HDi [D2]	2,2	125	4H... <DW12BTED4>	09.06→	DBB	4	0 445 115 025	0 986 435 351	
607									
2.0 HDi [Z8]	2,0	79/80	RHS <DW10ATED/FAP>; RHZ <DW10ATED>	03.00-11.04	DBB	4	0 445 110 076	0 986 435 077	
HDi [Z9]	2,0	79	RHS <DW10ATED>	12.04-12.07	DBB	4	0 445 110 076	0 986 435 077	
2.2 HDi [Z8]	2,2	98	4HX <DW12TED4>	03.00-11.04	DBB	4	0 445 110 036	0 986 435 013	0 986 435 014 0 986 435 015
HDi [Z9]	2,2	98	4HX <DW12TED4>	12.04-12.07	DBB	4	0 445 110 036	0 986 435 013	0 986 435 014 0 986 435 015
		125	4H ... <DW12BTED4>	05.06→	DBB	4	0 445 115 025	0 986 435 351	
806									
2.0 HDi [U60]	2,0	80	RHZ <DW10ATED>	08.99-08.02	DBB, I2G	4	0 445 110 044	0 986 435 003	
					<del>DBJ</del> , I1B	4	0 445 110 008	0 986 435 003	
		81	RHW <DW10ATED4/L4>	06.00-08.02	DBB	4	0 445 110 057	0 986 435 093	
807									
2.0 HDi [V2]	2,0	81	RH... <DW10ATED4/FAP>; RHW <DW10ATED4>	06.02-12.06	DBB	4	0 445 110 057	0 986 435 093	
2.2 HDi [V2]	2,2	94	4HW <DW12TED4/FAP>	06.02-07.06	DBB	4	0 445 110 036	0 986 435 013	0 986 435 014 0 986 435 015
		125	4H ... <DW12BTED4>	09.07-05.10	DBB	4	0 445 115 025	0 986 435 351	
1007									
1.6 HDi [A8]	1,6	80	9HZ <DV6TED4>	03.07→	DBJ	4	0 445 110 297	0 986 435 150	
3008									
1.6 HDi [T8]	1,6	80	9HZ <DV6TED4/FAP>	05.09→	DBJ	4	0 445 110 297	0 986 435 150	
4007									
2.2 HDi 4x4 [I3]	2,2	115	4HK <DW12ME5>; 4HN <DW12METED4 /FAP>	09.07→	DBB	4	0 445 115 025	0 986 435 351	
5008									
1.6 HDi [T8]	1,6	80	9H... <DV6TED4/FAP>	09.09→	DBJ	4	0 445 110 297	0 986 435 150	





RENAULT

Avantime									
2.2 DCI [XEO]	2,2	110	G9T 712	12.01-11.02	DBJ	4	0 445 110 063	0 986 435 075	
				12.02-12.03	DBJ	4	0 445 110 084		
Espace III									
2.2 dCi [JEO]	2,2	85-95	G9T...	07.00-10.02	DBJ	4	0 445 110 038	0 986 435 016	
Espace IV									
1.9 dCi [JKO]	1,9	88	F9Q 680; F9Q 826 F9Q 820	11.02-12.06	DBB	4	0 445 110 110	0 986 435 080	
				11.02-03.03	DBJ	4	0 445 110 146	0 986 435 007	
				04.03-12.06	DBB	4	0 445 110 110	0 986 435 080	
2.0 dCi [JK]	2,0	96/110/ 127	M9R 740; M9R 760	05.05→	DBB	4	0 445 115 007	0 986 435 350	
dCi [JKO]	2,0	127	M9R 761	05.05→	DBB	4	0 445 115 007	0 986 435 350	
2.2 dCi [JK]	2,2	102	G9T 645	07.05→	DBJ	4	0 445 110 261		
dCi [JKO]	2,2	110	G9T 742; G9T 743	11.02-12.06	DBJ	4	0 445 110 084		
Kangoo I									
1.9 DCI, DCI 4x4 [FC./KC.]	1,9	59	F9Q 790	05.00-12.07	DBJ	4	0 445 110 109	0 986 435 100	
Koleos									
2.0 dCi, dCi 4x4 [HY]	2,0	110/127	M9R 830; M9R 832; M9R 833	09.08→	DBB	4	0 445 115 007	0 986 435 350	
Laguna I									
1.9 DCI [B56]	1,9	80	F9Q 718	09.99-02.01	BO, DBJ	4	0 445 110 146	0 986 435 007	
Laguna I Grandtour									
1.9 DCI [K56]	1,9	80	F9Q 718	09.99-02.01	BO, DBJ	4	0 445 110 146	0 986 435 007	
Laguna II									
1.9 DCI [BG.]	1,9	68	F9Q 664	01.05-12.06	DBJ	4	0 445 110 178		
			F9Q 751	03.01-09.07	DBJ	4	0 445 110 146	0 986 435 007	
			F9Q 752	03.01-04.03	DBJ	4	0 445 110 146	0 986 435 007	
			F9Q 754	05.03-09.07	DBB	4	0 445 110 110	0 986 435 080	
		81	F9Q 754	03.01-08.02	DBJ	4	0 445 110 146	0 986 435 007	
			F9Q 670	09.04-09.07	DBB	4	0 445 110 110	0 986 435 080	
			F9Q 674	01.05-09.07	DBB	4	0 445 110 110	0 986 435 080	
		88	F9Q 650	05.02-09.07	DBJ	4	0 445 110 127		
			F9Q 750	03.01-04.03	DBJ	4	0 445 110 146	0 986 435 007	
		96	F9Q 758; F9Q 759	05.03-09.07	DBB	4	0 445 110 110	0 986 435 080	
01.05-09.07	DBJ	4	0 445 110 230	0 986 435 124					
2.0 DCI [BG.]	2,0	110/127	M9R 740; M9R 760	09.04-09.07	DBB	4	0 445 115 007	0 986 435 350	
2.2 DCI [BG.]	2,2	102	G9T 605	07.05-09.07	DBJ	4	0 445 110 261		
			G9T 700; G9T 702; G9T 703; G9T 706; G9T 707	03.01-09.07	DBJ	4	0 445 110 084		
Laguna II Grandtour									
1.9 DCI [KG.]	1,9	68	F9Q 664	01.05-12.06	DBJ	4	0 445 110 178		
			F9Q 752	03.01-04.03	DBJ	4	0 445 110 146	0 986 435 007	
			F9Q 754	05.03-12.05	DBB	4	0 445 110 110	0 986 435 080	
			F9Q 754	03.01-08.02	DBJ	4	0 445 110 146	0 986 435 007	
		81	F9Q 754	09.02-12.05	DBB	4	0 445 110 110	0 986 435 080	
			F9Q 670; F9Q 674	01.05-09.07	DBB	4	0 445 110 110	0 986 435 080	
			F9Q 650	05.02-09.07	DBJ	4	0 445 110 127		
		88	F9Q 750	03.01-04.03	DBJ	4	0 445 110 146	0 986 435 007	
			F9Q 750	05.03-12.05	DBB	4	0 445 110 110	0 986 435 080	
		96	F9Q 758; F9Q 759	04.04-09.07	DBJ	4	0 445 110 230	0 986 435 124	
2.0 DCI [KG.]	2,0	110/127	M9R 740; M9R 760	09.04-09.07	DBB	4	0 445 115 007	0 986 435 350	
2.2 DCI [KG.]	2,2	102	G9T 605	07.05-09.07	DBJ	4	0 445 110 261		
			G9T 700; G9T 702; G9T 703; G9T 706; G9T 707	03.01-09.07	DBJ	4	0 445 110 084		
Laguna III									
2.0 DCI [BT]	2,0	96/110/ 127/131	M9R 742; M9R 800; M9R 802; M9R 805; M9R 816	10.07→	DBB	4	0 445 115 007	0 986 435 350	
Laguna III Coupé									
2.0 DCI [DT]	2,0	110/127/ 131	M9R 742; M9R 800; M9R 802; M9R 805; M9R 816	02.08→	DBB	4	0 445 115 007	0 986 435 350	





◀ RENAULT

Laguna III Grandtour									
2.0 DCI [KT]	2,0	96/110/127/131	M9R 742; M9R 800; M9R 802; M9R 805; M9R 816	10.07→	DBB	4	0 445 115 007	0 986 435 350	
Megane I									
1.9 DCI [X64]	1,9	72-75	F9Q 732	03.99-08.02	DBJ	4	0 445 110 146	0 986 435 007	
				09.02-10.02	DBB	4	0 445 110 110	0 986 435 080	
		75	F9Q 733	05.00-10.02	BO, DBJ	4	0 445 110 146	0 986 435 007	
			F9Q 738	03.99-10.02	BO, DBJ	4	0 445 110 146	0 986 435 007	
				01.01-08.02	DBJ	4	0 445 110 146	0 986 435 007	
				09.02-10.02	DBB	4	0 445 110 110	0 986 435 080	
Megane I Classic									
1.9 DCI [X64]	1,9	72-75	F9Q 732	04.99-08.02	DBJ	4	0 445 110 146	0 986 435 007	
				09.02-09.03	DBB	4	0 445 110 110	0 986 435 080	
			F9Q 733	04.99-09.03	BO, DBJ	4	0 445 110 146	0 986 435 007	
		75	F9Q 738	05.00-09.03	DBJ	4	0 445 110 109	0 986 435 100	
Megane I Coupé									
1.9 DCI [X64]	1,9	72-75	F9Q 732	03.99-08.02	DBJ	4	0 445 110 146	0 986 435 007	
				09.02-10.02	DBB	4	0 445 110 110	0 986 435 080	
		75	F9Q 733	05.00-10.02	BO, DBJ	4	0 445 110 146	0 986 435 007	
Megane I Grandtour									
1.9 DCI [X64]	1,9	72-75	F9Q 732	03.99-08.02	DBJ	4	0 445 110 146	0 986 435 007	
				09.02-09.03	DBB	4	0 445 110 110	0 986 435 080	
			F9Q 733; F9Q 738	03.99-09.03	BO, DBJ	4	0 445 110 146	0 986 435 007	
Megane II									
1.9 DCI [LM]	1,9	68	F9Q 808	10.03-10.09	DBJ	4	0 445 110 178		
		88	F9Q 800	10.03-10.09	DBB	4	0 445 110 110	0 986 435 080	
		96	F9Q 803; F9Q 804	09.04-10.09	DBJ	4	0 445 110 230	0 986 435 124	
2.0 DCI [LM]	2,0	110	M9R 700	09.04-10.09	DBB	4	0 445 115 007	0 986 435 350	
Megane II Cabrio									
1.9 DCI [EM]	1,9	88	F9Q 800	10.03-03.10	DBB	4	0 445 110 110	0 986 435 080	
		96	F9Q 803; F9Q 804; F9Q 814	05.04-03.10	DBJ	4	0 445 110 230	0 986 435 124	
2.0 DCI [EM]	2,0	110	M9R 700; M9R 722	09.04-03.10	DBB	4	0 445 115 007	0 986 435 350	
Megane II Grandtour									
1.9 DCI [KM.]	1,9	68	F9Q 808	10.03-05.09	DBJ	4	0 445 110 178		
		88	F9Q 800	10.03-05.09	DBB	4	0 445 110 110	0 986 435 080	
		96	F9Q 803; F9Q 804	09.04-05.09	DBJ	4	0 445 110 230	0 986 435 124	
2.0 DCI [KM.]	2,0	110	M9R 700; M9R 722	09.04-05.09	DBB	4	0 445 115 007	0 986 435 350	
Megane II Hatchback									
1.9 DCI [BM./CM./GM./SM.]	1,9	68	F9Q 808	11.02-10.08	DBJ	4	0 445 110 178		
		88	F9Q 800	11.02-10.08	DBB	4	0 445 110 110	0 986 435 080	
		96	F9Q 803; F9Q 804	09.04-10.08	DBJ	4	0 445 110 230	0 986 435 124	
2.0 DCI [BM./CM./GM./SM.]	2,0	110	M9R 700; M9R 722	09.04-10.08	DBB	4	0 445 115 007	0 986 435 350	
Megane III CC									
1.9 dCi [EZ]	1,9	96	F9Q 870	10.10→	DBJ	4	0 445 110 328		
Megane III Coupé									
1.9 dCi [DZ]	1,9	96	F9Q 870; F9Q 872	01.09→	DBJ	4	0 445 110 328		
Megane III Grandtour									
1.9 dCi [KZ]	1,9	96	F9Q 870; F9Q 872	06.09→	DBJ	4	0 445 110 328		
Megane III Hatchback									
1.9 dCi [BZ]	1,9	96	F9Q 870; F9Q 872	11.08→	DBJ	4	0 445 110 328		
Scenic I									
1.9 DCI [JA.]	1,9	75	F9Q 738	09.00-04.03	DBJ	4	0 445 110 109	0 986 435 100	
				03.99-08.02	DBJ	4	0 445 110 146	0 986 435 007	
				09.02-04.03	DBB	4	0 445 110 110	0 986 435 080	
			F9Q 733	10.99-04.03	DBB	4	0 445 110 110	0 986 435 080	
			F9Q 740	06.00-04.03	DBJ	4	0 445 110 146	0 986 435 007	
			F9Q 746; F9Q 748	02.01-04.03	DBJ	4	0 445 110 146	0 986 435 007	
			F9Q 796	06.97-04.03	DBJ	4	0 445 110 160	0 986 435 098	
Scenic II									
1.9 DCI [JM]	1,9	81/96	F9Q 803; F9Q 804	05.03-04.09	DBJ	4	0 445 110 230	0 986 435 124	
		88	F9Q 812	05.03-04.09	DBB	4	0 445 110 110	0 986 435 080	
2.0 DCI [JM]	2,0	110	M9R 700; M9R 721	09.04-04.09	DBB	4	0 445 115 007	0 986 435 350	







<b>Scenic III</b>										
1.9 dCi [J95]	1,9	96	F9Q 870; F9Q 872		05.09→	DBJ	4	0 445 110 328		
<b>Vel Satis</b>										
2.0 DCI [BJ]	2,0	110/127	M9R 760		08.05-12.09	DBB	4	0 445 115 007	0 986 435 350	
2.2 DCI [BJ]	2,2	102	G9T 607		07.05-12.09	DBJ	4	0 445 110 261		
		110	G9T 702; G9T 703		04.02-12.09	DBJ	4	0 445 110 084		

**ROVER**

<b>75</b>										
2.0 CDT, CDTi	2,0	85/96	20 4D 2 <M 47 D 20>		01.99-05.05	DBJ	4	0 445 110 030	0 986 435 011	
<b>75 Tourer</b>										
2.0 CDT, CDTi	2,0	85/96	20 4D 2 <M 47 D 20>		01.01-05.05	DBJ	4	0 445 110 030	0 986 435 011	

**SAAB (SAAB AUTOMOBILE AB)**

<b>9-3</b>												
1.9 TiD [9440]	1,9	88	Z19DT									
			Fg.Nr. →71019398→76004481	09.04→	DBB	4	0 445 110 165	0 986 435 103				
			Fg.Nr. 71100001→76100001→	09.04→		4	0 433 171 822					
			110	Z19DTH								
			Fg.Nr. →71019398→76004481	09.04→	DBB	4	0 445 110 159	0 986 435 088				
			Fg.Nr. 71100001→76100001→	09.04→	DBB	4	0 445 110 243	0 986 435 104				
<b>9-3 Cabriolet</b>												
1.9 TiD [9440]	1,9	110	Z19DTH									
			Fg.Nr. →71019398→76004481	01.06→	DBB	4	0 445 110 159	0 986 435 088				
			Fg.Nr. 71100001→76100001→	01.06→	DBB	4	0 445 110 243	0 986 435 104				
<b>9-3 Kombi</b>												
1.9 TiD [9440]	1,9	88	Z19DT									
			Fg.Nr. →71019398→76004481	03.05→	DBB	4	0 445 110 165	0 986 435 103				
			Fg.Nr. 71100001→76100001→	03.05→		4	0 433 171 822					
			110	Z19DTH								
						Fg.Nr. →71019398→76004481	03.05→	DBB	4	0 445 110 159	0 986 435 088	
						Fg.Nr. 71100001→76100001→	03.05→	DBB	4	0 445 110 243	0 986 435 104	
<b>9-5</b>												
1.9 TiD [9600]	1,9	110	Z19DTH		09.05-02.10	DBB	4	0 445 110 243	0 986 435 104			
2.0 TiD4 [650]	2,0	118	A 20 DTH		03.10→	DBB	4	0 445 110 327				
<b>9-5 Kombi</b>												
1.9 TiD [9600]	1,9	110/129	Z19DTH		01.06-02.10	DBB	4	0 445 110 243	0 986 435 104			

**SEAT**

<b>Alhambra</b>										
2.0 TDI, TDI 4WD [710]	2,0	85/100/103/125	CFFA; CFFB; CFFB <D91>; CFFE <DE4>; CFGB		05.10→	DBJ	4	0 445 110 368	0 986 435 166	
<b>Altea</b>										
2.0 TDI [5P1]	2,0	103	CFHC <D91>		09.10→	DBJ	4	0 445 110 368	0 986 435 166	
		125	CEGA <D93>		03.09-05.10	DBJ	4	0 445 116 029	0 986 435 360	
<b>Altea Freetrack</b>										
2.0 TDI 4WD [5P5/5P8]	2,0	103/125	CFHC <D91>; CFJA <D93>		09.10→	DBJ	4	0 445 110 368	0 986 435 166	
		125	CEGA <D93>		03.09-10.10	DBJ	4	0 445 116 029	0 986 435 360	
<b>Altea XL</b>										
2.0 TDI [5P5]	2,0	103	CFHC <D91>		10.10→	DBJ	4	0 445 110 368	0 986 435 166	
		125	CEGA <D93>		03.09-05.10	DBJ	4	0 445 116 029	0 986 435 360	
<b>Exeo</b>										
2.0 TDI [3R2]	2,0	88/105/125	CAGA <D92>; CAGC <D90>; CAHA <D93>		12.08→	DBJ	4	0 445 116 029	0 986 435 360	
<b>Exeo ST</b>										
2.0 TDI [3R5]	2,0	88/105/125	CAGA <D92>; CAGC <D90>; CAHA <D93>		06.09→	DBJ	4	0 445 116 029	0 986 435 360	





◀ SEAT

<b>Ibiza</b>									
2.0 TDI [6J5]	2,0	105	CFHD <D92>	01.10→	DBJ	4	0 445 110 368	0 986 435 166	
<b>Ibiza Sportcoupé</b>									
2.0 TDI [6J1]	2,0	105	CFHD <D92>	01.10→	DBJ	4	0 445 110 368	0 986 435 166	
<b>Leon</b>									
2.0 TDI [1P1]	2,0	103/125	CFHC <D91>; CFJA <D93>; CLCB <D91>	05.10→	DBJ	4	0 445 110 368	0 986 435 166	
		125	CEGA <D93>	03.09→	DBJ	4	0 445 116 029	0 986 435 360	

**SKODA**

<b>Octavia</b>									
2.0 TDI RS [1Z3]	2,0	125	CEGA <D93>	05.08→	DBJ	4	0 445 116 029	0 986 435 360	
TDI, TDI 4x4 [1Z3]	2,0	81/103	CFHC <D91>; CFHF <D96>; CLCA <D96>; CLCB <D91>	02.10→	DBJ	4	0 445 110 368	0 986 435 166	
<b>Octavia Combi</b>									
2.0 TDI RS [1Z5]	2,0	125	CEGA <D93>	05.08→	DBJ	4	0 445 116 029	0 986 435 360	
TDI, TDI 4x4 [1Z5]	2,0	81/103	CFHC <D91>; CFHF <D96>; CLCA <D96>; CLCB <D91>	02.10→	DBJ	4	0 445 110 368	0 986 435 166	
<b>Superb</b>									
2.0 TDI, TDI 4x4 [3T4]	2,0	103/125	CFFB <D91>; CFGB; CLJA	02.10→	DBJ	4	0 445 110 368	0 986 435 166	
		125	CBBB	06.08→	DBJ	4	0 445 116 029	0 986 435 360	
<b>Superb Combi</b>									
2.0 TDI, TDI 4x4 [3T5]	2,0	103/125	CFFB <D91>; CFGB; CLJA <D91>	02.10→	DBJ	4	0 445 110 368	0 986 435 166	
		125	CBBB	09.09→	DBJ	4	0 445 116 029	0 986 435 360	
<b>Yeti</b>									
2.0 TDI, TDI 4x4 [5L7]	2,0	81/103/125	CFHA <D96>; CFHC <D91>; CFHF <D96>; CFJA <D93>; CLCA <D96>; CLCB <D91>	11.09→	DBJ	4	0 445 110 368	0 986 435 166	
TDI 4x4 [5L7]	2,0	103/125	CBDB <D91>; CEGA <D93>	05.09-05.10	DBJ	4	0 445 116 029	0 986 435 360	

**SMART (MCC)**

<b>Forfour</b>									
1.5 cdi [454]	1,5	50/70	639.939	09.04-06.07	DBB	3	0 445 110 166	0 986 435 117	0 986 435 118
<b>Fortwo Cabrio</b>									
0.8 [451]	0,8	33/40	660.950; 660.951 <OM 660>	04.07→	DBB	3	0 445 110 302		
cdi [450]	0,8	30	OM 660.940	02.04-03.07	DBB	3	0 445 110 022	0 986 435 008	
<b>Fortwo Coupé</b>									
0.8 [451]	0,8	33/40	660.950; 660.951 <OM 660>	04.07→	DBB	3	0 445 110 302		
cdi [450]	0,8	30	OM 660.940	02.04-03.07	DBB	3	0 445 110 022	0 986 435 008	
<b>Smart Cabrio</b>									
0.8 cdi [450]	0,8	30	OM 660.940	03.01-01.04	DBB	3	0 445 110 022	0 986 435 008	
<b>Smart Coupé</b>									
0.8 cdi [450]	0,8	30	OM 660.940	11.99-01.04	DBB	3	0 445 110 022	0 986 435 008	

**SUZUKI**

<b>Grand Vitara</b>									
2.0 D Turbo	2,0	80	RHZ	11.00-12.05	DBB	4	0 445 110 044	0 986 435 003	
<b>Ignis Hatchback</b>									
1.3 DDiS Turbo	1,2	51	Z13DT	10.03-12.07	DBB	4	0 445 110 083	0 986 435 078	
<b>Swift Hatchback</b>									
1.3 DDiS D Turbo [MZ/EZ]	1,2	51-55	Z13DT						
			Fg.Nr. →00500000	08.05→	DBB	4	0 445 110 083	0 986 435 078	
<b>SX4 Hatchback</b>									
1.6 DDiS	1,6	66	9HX	04.07→	DBJ	4	0 445 110 239	0 986 435 122	
1.9 DDiS, DDiS 4WD	1,9	88	D19AA	05.06→	DBB	4	0 445 110 276	0 986 435 148	
<b>Wagon R+</b>									
1.3 DDiS D Turbo [MM]	1,3	51	Z13DT	09.03-03.06	DBB	4	0 445 110 083	0 986 435 078	



## UAZ

**Patriot**

2.2 TD 4x4	2,3	85	F1AE0481B	01.07→	DBJ	4	0 445 110 273	0 986 435 165
------------	-----	----	-----------	--------	-----	---	---------------	---------------

## VAUXHALL

**Agila**

1.3 CDTI [B]	1,2	55	Z 13 DTJ	07.08→	DBB	4	0 445 110 183	0 986 435 102
--------------	-----	----	----------	--------	-----	---	---------------	---------------

**Antara**

2.0 CDTI 4x4	2,0	93/110	Z 20 DM <Ecotec>; Z 20 DMH <Ecotec>	11.06→	DBJ	4	0 445 110 269	0 986 435 153
--------------	-----	--------	-------------------------------------	--------	-----	---	---------------	---------------

**Astra**

1.3 CDTI [H]	1,3	66	Z 13 DTH <Ecotec>	01.06-03.10	DBB	4	0 445 110 183	0 986 435 102
--------------	-----	----	-------------------	-------------	-----	---	---------------	---------------

1.7 CDTI [H]	1,7	59	Z 17 DTL <Turbo Ecotec>	03.04-03.07	DBJ	4	0 445 110 174	0 986 435 105
--------------	-----	----	-------------------------	-------------	-----	---	---------------	---------------

		74	Z 17 DTH <Turbo Ecotec>	03.04-03.07	DBJ	4	0 445 110 175	0 986 435 089
--	--	----	-------------------------	-------------	-----	---	---------------	---------------

CDTI 16V [G]	1,7	59	Z 17 DTL <Turbo>	03.03-08.05	DBJ	4	0 445 110 118	0 986 435 082
--------------	-----	----	------------------	-------------	-----	---	---------------	---------------

1.9 CDTI [H]	1,9	74	Z 19 DTL <Turbo Ecotec>					
--------------	-----	----	-------------------------	--	--	--	--	--

			Fg.Nr. →72045139→75030986	09.05-03.10	DBB	4	0 445 110 165	0 986 435 103
--	--	--	---------------------------	-------------	-----	---	---------------	---------------

			→78025126					
--	--	--	-----------	--	--	--	--	--

			Fg.Nr. 72045140→75030987→	09.05-03.10	DBB	4	0 445 110 276	0 986 435 148
--	--	--	---------------------------	-------------	-----	---	---------------	---------------

			78025127→78007392→					
--	--	--	--------------------	--	--	--	--	--

88			Z 19 DT <Turbo Ecotec>					
----	--	--	------------------------	--	--	--	--	--

			Fg.Nr. →72045139→75030986	09.05-03.10	DBB	4	0 445 110 165	0 986 435 103
--	--	--	---------------------------	-------------	-----	---	---------------	---------------

			→78025126					
--	--	--	-----------	--	--	--	--	--

			Fg.Nr. 72045140→75030987→	09.05-03.10	DBB	4	0 445 110 276	0 986 435 148
--	--	--	---------------------------	-------------	-----	---	---------------	---------------

			78025127→78007392→					
--	--	--	--------------------	--	--	--	--	--

			Z 19 DTJ <Turbo Ecotec>					
--	--	--	-------------------------	--	--	--	--	--

			Fg.Nr. →72045139→75030986	03.04-03.10	DBB	4	0 445 110 159	0 986 435 088
--	--	--	---------------------------	-------------	-----	---	---------------	---------------

			→78025126					
--	--	--	-----------	--	--	--	--	--

			Fg.Nr. 72045140→75030987→	03.04-03.10	DBB	4	0 445 110 243	0 986 435 104
--	--	--	---------------------------	-------------	-----	---	---------------	---------------

			78025127→					
--	--	--	-----------	--	--	--	--	--

110			Z 19 DTH <Turbo Ecotec>					
-----	--	--	-------------------------	--	--	--	--	--

			Fg.Nr. →72045139→75030986	03.04-03.10	DBB	4	0 445 110 159	0 986 435 088
--	--	--	---------------------------	-------------	-----	---	---------------	---------------

			→78025126					
--	--	--	-----------	--	--	--	--	--

			Fg.Nr. 72045140→75030987→	03.04-03.10	DBB	4	0 445 110 243	0 986 435 104
--	--	--	---------------------------	-------------	-----	---	---------------	---------------

			78025127→					
--	--	--	-----------	--	--	--	--	--

2.0 CDTI [J]	2,0	118/121	A 20 DTH <Ecotec>	09.09→	DBB	4	0 445 110 327	
--------------	-----	---------	-------------------	--------	-----	---	---------------	--

**Astra Estate**

1.3 CDTI [H]	1,3	66	Z 13 DTH <Ecotec>	06.05-03.10	DBB	4	0 445 110 183	0 986 435 102
--------------	-----	----	-------------------	-------------	-----	---	---------------	---------------

1.7 CDTI [G]	1,7	59	Z 17 DTL <Turbo>	03.03-08.05	DBJ	4	0 445 110 118	0 986 435 082
--------------	-----	----	------------------	-------------	-----	---	---------------	---------------

CDTI [H]	1,7	59	Z 17 DTL <Turbo Ecotec>	09.04-03.07	DBJ	4	0 445 110 174	0 986 435 105
----------	-----	----	-------------------------	-------------	-----	---	---------------	---------------

		74	Z 17 DTH <Turbo Ecotec>	08.04-03.07	DBJ	4	0 445 110 175	0 986 435 089
--	--	----	-------------------------	-------------	-----	---	---------------	---------------

1.9 CDTI [H]	1,9	74	Z 19 DTL <Turbo Ecotec>					
--------------	-----	----	-------------------------	--	--	--	--	--

			Fg.Nr. →72045139→75030986	09.05-03.10	DBB	4	0 445 110 165	0 986 435 103
--	--	--	---------------------------	-------------	-----	---	---------------	---------------

			→78025126					
--	--	--	-----------	--	--	--	--	--

			Fg.Nr. 72045140→75030987→	09.05-03.10	DBB	4	0 445 110 276	0 986 435 148
--	--	--	---------------------------	-------------	-----	---	---------------	---------------

			78025127→78007392→					
--	--	--	--------------------	--	--	--	--	--

88			Z 19 DT <Turbo Ecotec>					
----	--	--	------------------------	--	--	--	--	--

			Fg.Nr. →72045139→75030986	09.05-03.10	DBB	4	0 445 110 165	0 986 435 103
--	--	--	---------------------------	-------------	-----	---	---------------	---------------

			→78025126					
--	--	--	-----------	--	--	--	--	--

			Fg.Nr. 72045140→75030987→	09.05-03.10	DBB	4	0 445 110 276	0 986 435 148
--	--	--	---------------------------	-------------	-----	---	---------------	---------------

			78025127→78007392→					
--	--	--	--------------------	--	--	--	--	--

			Z 19 DTJ <Turbo Ecotec>					
--	--	--	-------------------------	--	--	--	--	--

			Fg.Nr. →72045139→75030986	08.04-03.10	DBB	4	0 445 110 159	0 986 435 088
--	--	--	---------------------------	-------------	-----	---	---------------	---------------

			→78025126					
--	--	--	-----------	--	--	--	--	--

			Fg.Nr. 72045140→75030987→	08.04-03.10	DBB	4	0 445 110 243	0 986 435 104
--	--	--	---------------------------	-------------	-----	---	---------------	---------------

			78025127→					
--	--	--	-----------	--	--	--	--	--





◀ VAUXHALL

<b>1.9 CDTi [H]</b>	1,9	110	Z 19 DTH <Turbo Ecotec> Fg.Nr. →72045139 →75030986 →78025126	08.04-03.10	DBB	4	<b>0 445 110 159</b>	<b>0 986 435 088</b>	
			Fg.Nr. 72045140 → 75030987 → 78025127 →	08.04-03.10	DBB	4	<b>0 445 110 243</b>	<b>0 986 435 104</b>	
<b>Astra GTC</b>									
<b>1.7 CDTi [H]</b>	1,7	59	Z 17 DTL <Turbo Ecotec>	09.05-03.07	<del>DBB</del>	4	<b>0 445 110 174</b>	<b>0 986 435 105</b>	
		74	Z 17 DTH <Turbo Ecotec>	06.05-03.07	<del>DBB</del>	4	<b>0 445 110 175</b>	<b>0 986 435 089</b>	
<b>1.9 CDTi [H]</b>	1,9	88	Z 19 DTJ <Turbo Ecotec> Fg.Nr. →72045139 →75030986 →78025126	06.05-03.09	DBB	4	<b>0 445 110 159</b>	<b>0 986 435 088</b>	
			Fg.Nr. 72045140 → 75030987 → 78025127 →	06.05-03.09	DBB	4	<b>0 445 110 243</b>	<b>0 986 435 104</b>	
		110	Z 19 DTH <Turbo Ecotec> Fg.Nr. →72045139 →75030986 →78025126	06.05-12.09	DBB	4	<b>0 445 110 159</b>	<b>0 986 435 088</b>	
			Fg.Nr. 72045140 → 75030987 → 78025127 →	06.05-12.09	DBB	4	<b>0 445 110 243</b>	<b>0 986 435 104</b>	
<b>2.0 [J]</b>	2,0	121	A 20 DTH <ecoFLEX>	09.11 →	DBB	4	<b>0 445 110 327</b>		
<b>Astra Sports Tourer</b>									
<b>2.0 CDTi [J]</b>	2,0	118/121	A 20 DTH; A 20 DTH <Ecotec>	09.10 →	DBB	4	<b>0 445 110 327</b>		
<b>Astra TwinTop</b>									
<b>1.9 CDTi [H]</b>	1,9	110	Z 19 DTH <Ecotec> Fg.Nr. →72045139 →75030986 →78025126	09.05-12.09	DBB	4	<b>0 445 110 159</b>	<b>0 986 435 088</b>	
			Fg.Nr. 72045140 → 75030987 → 78025127 →	09.05-12.09	DBB	4	<b>0 445 110 243</b>	<b>0 986 435 104</b>	
<b>Astra Van</b>									
<b>1.7 CDTi [G]</b>	1,7	59	Z 17 DTL <Turbo>	03.03-08.05	<del>DBB</del>	4	<b>0 445 110 118</b>	<b>0 986 435 082</b>	
<b>Combo</b>									
<b>1.3 CDTi [Tour]</b>	1,2	51	Z 13 DT <Turbo>	09.04 →	DBB	4	<b>0 445 110 083</b>	<b>0 986 435 078</b>	
	1,3	51/55	Y 13 DT <Turbo>; Z 13 DTJ <Turbo>	09.04 →	DBB	4	<b>0 445 110 083</b>	<b>0 986 435 078</b>	
<b>Corsa</b>									
<b>1.3 CDTi [C]</b>	1,2	51	Z 13 DT	09.03-09.06	DBB	4	<b>0 445 110 083</b>	<b>0 986 435 078</b>	
	1,3	51	Y 13 DT <Turbo Ecotec>	09.03-09.06	DBB	4	<b>0 445 110 083</b>	<b>0 986 435 078</b>	
		55	Z 13 DTJ <Turbo Ecotec>	09.05-09.06	DBB	4	<b>0 445 110 183</b>	<b>0 986 435 102</b>	
CDTi [D]	1,2	55/66	Z 13 DTH <Turbo Ecotec>; Z 13 DTJ <Turbo Ecotec>	07.06 →	DBB	4	<b>0 445 110 183</b>	<b>0 986 435 102</b>	
	1,3	55/66	A 13 DTH <Turbo Ecotec>; A 13 DTJ <Turbo Ecotec>	10.06-02.09	DBB	4	<b>0 445 110 183</b>	<b>0 986 435 102</b>	
<b>Insignia</b>									
<b>2.0 CDTi [68]</b>	2,0	81	A 20 DT... <Ecotec>	11.08 →	<del>DBB</del>	4	<b>0 445 110 423</b>		
		96	A 20 DT... <eco Flex> Mot.Typ DT	11.08 →	<del>DBB</del> , TW	4	<b>0 445 110 423</b>		
			Mot.Typ DTJ	11.08 →	DBB, TW	4	<b>0 445 110 327</b>		
CDTi [69]	2,0	81	A 20 DT... <Ecotec>	11.08 →	<del>DBB</del>	4	<b>0 445 110 423</b>		
		96	A 20 DT... <eco Flex> Mot.Typ DT	11.08 →	<del>DBB</del> , TW	4	<b>0 445 110 423</b>		
			Mot.Typ DTJ	11.08 →	DBB, TW	4	<b>0 445 110 327</b>		
CDTi, CDTi 4x4 [68]	2,0	118	A 20 DTH <ecoFlex>	11.08 →	DBB	4	<b>0 445 110 327</b>		
CDTi, CDTi 4x4 [69]	2,0	118	A 20 DTH <ecoFlex>	11.08 →	DBB	4	<b>0 445 110 327</b>		
<b>Insignia Sports Tourer</b>									
<b>2.0 CDTi [35]</b>	2,0	81	A 20 DT... <Ecotec>	02.09 →	<del>DBB</del>	4	<b>0 445 110 423</b>		
		96	A 20 DT... <eco Flex> Mot.Typ DT	02.09 →	<del>DBB</del> , TW	4	<b>0 445 110 423</b>		
			Mot.Typ DTJ	02.09 →	DBB, TW	4	<b>0 445 110 327</b>		
CDTi, CDTi 4x4 [35]	2,0	118	A 20 DTH <ecoFlex>	02.09 →	DBB	4	<b>0 445 110 327</b>		
<b>Meriva</b>									
<b>1.3 CDTi [A]</b>	1,2	51	Y 13 DT <Ecotec>; Z 13 DT <Ecotec>	09.05-03.10	DBB	4	<b>0 445 110 083</b>	<b>0 986 435 078</b>	
	1,3	55	Z 13 DTJ <Ecotec>	09.03-03.10	DBB	4	<b>0 445 110 183</b>	<b>0 986 435 102</b>	





<b>Signum</b>									
1.9 CDTI	1,9	74	Z 19 DTL <Ecotec>						
			Fg.Nr. →71021891	09.05-09.08	DBB	4	0 445 110 165	0 986 435 103	
			Fg.Nr. 71021892→	09.05-09.08	DBB	4	0 445 110 276	0 986 435 148	
		88	Z 19 DT <Ecotec>						
			Fg.Nr. →71021891	04.04-09.08	DBB	4	0 445 110 165	0 986 435 103	
			Fg.Nr. 71021892→	04.04-09.08	DBB	4	0 445 110 276	0 986 435 148	
		110	Z 19 DTH <Ecotec>						
			Fg.Nr. →71021891	04.04-09.08	DBB	4	0 445 110 159	0 986 435 088	
			Fg.Nr. 71021892→	04.04-09.08	DBB	4	0 445 110 243	0 986 435 104	
<b>Tigra TwinTop</b>									
1.3 CDTI [B]	1,3	51	Z 13 DT <Turbo Ecotec>	06.04-03.09	DBB	4	0 445 110 083	0 986 435 078	
<b>Vectra</b>									
1.9 CDTI [C]	1,9	74	Z 19 DTL <Ecotec>						
			Fg.Nr. →71021891 →48999999	09.05-10.08	DBB	4	0 445 110 165	0 986 435 103	
			Fg.Nr. 71021892→	09.05-10.08	DBB	4	0 445 110 276	0 986 435 148	
		88	Z 19 DT <Ecotec>						
			Fg.Nr. →71021891 →48999999	04.04-10.08	DBB	4	0 445 110 165	0 986 435 103	
			Fg.Nr. 71021892→	04.04-10.08	DBB	4	0 445 110 276	0 986 435 148	
		110	Z 19 DTH <Ecotec>						
			Fg.Nr. →71021891 →48999999	04.04-03.08	DBB	4	0 445 110 159	0 986 435 088	
			Fg.Nr. 71021892→	04.04-03.08	DBB	4	0 445 110 243	0 986 435 104	
<b>Vectra Estate</b>									
1.9 CDTI [C]	1,9	74	Z 19 DTL <Ecotec>						
			Fg.Nr. →71021891 →48999999	09.05-10.08	DBB	4	0 445 110 165	0 986 435 103	
			Fg.Nr. 71021892→	09.05-10.08	DBB	4	0 445 110 276	0 986 435 148	
		88	Z 19 DT <Ecotec>						
			Fg.Nr. →71021891 →48999999	04.04-10.08	DBB	4	0 445 110 165	0 986 435 103	
			Fg.Nr. 71021892→	04.04-10.08	DBB	4	0 445 110 276	0 986 435 148	
		110	Z 19 DTH <Ecotec>						
			Fg.Nr. →71021891 →48999999	04.04-03.08	DBB	4	0 445 110 159	0 986 435 088	
			Fg.Nr. 71021892→	04.04-03.08	DBB	4	0 445 110 243	0 986 435 104	
<b>Zafira</b>									
1.9 CDTI [B]	1,9	74	Z 19 DTL <Ecotec>						
			Fg.Nr. →62999999 →6G999999	07.05-03.08	DBB	4	0 445 110 165	0 986 435 103	
			Fg.Nr. 72000001 →7G000001→	07.05-03.08	DBB	4	0 445 110 276	0 986 435 148	
		88	Z 19 DT <Ecotec>						
			Fg.Nr. →62999999 →6G999999	07.05→	DBB	4	0 445 110 165	0 986 435 103	
			Fg.Nr. 72000001 →7G000001→	07.05→	DBB	4	0 445 110 276	0 986 435 148	
		110	Z 19 DTH <Ecotec>						
				07.05→	DBB	4	0 445 110 159	0 986 435 088	

**VOLVO**

<b>C30</b>									
1.6 D DRIVE	1,6	80	D4164T...						
			Fg.Nr. →26508	10.06-07.11	DBJ	4	0 445 110 188	0 986 435 090	
			Fg.Nr. 26509→	10.06-07.11	DBJ	4	0 445 110 259	0 986 435 126	
2.0 D3, D4	2,0	110/130	D5204T; D5204T5	08.10→	DBJ	5	0 445 116 045		
2.4 D5	2,4	120/132	D5244T8...; D5244T9	10.06-07.10	DBJ	5	0 445 110 251	0 986 435 125	
<b>C70 II Cabrio</b>									
2.0 D3	2,0	110	D5204T5	10.10→	DBJ	5	0 445 116 045		
2.4 D, D5	2,4	120/132	D5244T8...; D5244T9	08.06-07.10	DBJ	5	0 445 110 251	0 986 435 125	
<b>S40 II</b>									
1.6 D DRIVE	1,6	80-81	D4164T...	11.04→	DBJ	4	0 445 110 188	0 986 435 090	
2.0 D3, D4	2,0	110/130	D5204T; D5204T5	08.10→	DBJ	5	0 445 116 045		
2.4 D5	2,4	120/132	D5244T8...; D5244T9	03.06-07.10	DBJ	5	0 445 110 251	0 986 435 125	
<b>S60 I</b>									
2.4 D	2,4	96/120	D5244T; D5244T2	08.01-07.06	DBJ	5	0 445 110 078	0 986 435 120	
D, D5	2,4	93/120/136	D5244T4; D5244T5; D5244T7	08.05-07.09	DBJ	5	0 445 110 251	0 986 435 125	





◀ VOLVO

S60 II									
2.0 D3	2,0	120	D5204T2; D5204T3	08.10→	DBJ	5	0 445 116 045		
2.4 D5, D5 AWD	2,4	151/158	D5244T10; D5244T15	08.10→	DBJ	5	0 445 116 016		
S80 I									
2.4 D, D5	2,4	96/120	D5244T; D5244T2	08.01-07.06	DBJ	5	0 445 110 078	0 986 435 120	
S80 II									
1.6 D DRIVE	1,6	80	D4164T	08.09→	DBJ	4	0 445 110 259	0 986 435 126	
2.0 D3	2,0	120	D5204T2; D5204T3	08.10→	DBJ	5	0 445 116 045		
2.4 D	2,4	120	D5244T5						
			Fg.Nr. →45801	08.06-07.09	DBJ	5	0 445 110 251	0 986 435 125	
			Fg.Nr. 45802→	08.06-07.09	DBJ	5	0 445 110 298		
D5, D5 AWD	2,4	136	D5244T4	03.06-07.09	DBJ	5	0 445 110 251	0 986 435 125	
		151/158	D5244T10; D5244T15	11.08→	DBJ	5	0 445 116 016		
V50									
1.6 D DRIVE	1,6	80-81	D4164T...	11.04→	DBJ	4	0 445 110 188	0 986 435 090	
2.0 D3, D4	2,0	110/130	D5204T; D5204T5	08.10→	DBJ	5	0 445 116 045		
2.4 D5	2,4	120/132	D5244T8...; D5244T9	04.06-07.10	DBJ	5	0 445 110 251	0 986 435 125	
V60									
2.0 D3	2,0	120	D5204T2	09.10→	DBJ	5	0 445 116 045		
2.4 D5, D5 AWD	2,4	151/158	D5244T10; D5244T15	09.10→	DBJ	5	0 445 116 016		
V70 II									
2.4 D, D AWD, D5, D5 AWD	2,4	96/120/136	D5244T; D5244T2; D5244T3	08.01-07.06	DBJ	5	0 445 110 078	0 986 435 120	
D, D5, D5 AWD	2,4	90/93/120/136	D5244T4; D5244T5; D5244T6; D5244T7	08.06-07.07	DBJ	5	0 445 110 251	0 986 435 125	
V70 III									
1.6 D DRIVE	1,6	80	D4164T	01.10-07.11	DBJ	4	0 445 110 259	0 986 435 126	
2.0 D3	2,0	120	D5204T2; D5204T3	08.10→	DBJ	5	0 445 116 045		
2.4 D, D5, D5 AWD	2,4	120/136	D5244T4; D5244T5	08.07-07.09	DBJ	5	0 445 110 298		
D5, D5 AWD	2,4	151/158	D5244T10; D5244T11; D5244T15	08.09→	DBJ	5	0 445 116 016		
XC60									
2.0 D3 DRIVE	2,0	120	D5204T2; D5204T3	08.10→	DBJ	5	0 445 116 045		
2.4 D AWD, D3 AWD, D5 AWD	2,4	120/151/158	D 5244...; D5244T10; D5244T16; D5244T17	08.09→	DBJ	5	0 445 116 016		
D AWD, D5 AWD	2,4	120/136	D5244T4; D5244T5	03.09-07.09	DBJ	5	0 445 110 298		
XC70 I									
2.4 D	2,4	120	D5244T	08.02-07.06	DBJ	5	0 445 110 078	0 986 435 120	
D5	2,4	136	D5244T4	12.05-07.07	DBJ	5	0 445 110 251	0 986 435 125	
XC70 II									
2.0 D3 DRIVE	2,0	120	D5204T2; D5204T3	08.10→	DBJ	5	0 445 116 045		
2.4 D AWD, D3 AWD, D5 AWD	2,4	120/151/158	D5244T10; D5244T11; D5244T15; D5244T16; D5244T17	08.09→	DBJ	5	0 445 116 016		
D AWD, D5 AWD	2,4	120/136	D5244T4; D5244T5	08.07-07.09	DBJ	5	0 445 110 298		
XC90									
2.4 D3 FWD, D5 AWD	2,4	120/136/147	D5244T4; D5244T5; D5244T18	05.05→	DBJ	5	0 445 110 251	0 986 435 125	
D5 AWD	2,4	120	D5244T	01.03-07.06	DBJ	5	0 445 110 078	0 986 435 120	



VW (VOLKSWAGEN)

Amarok									
2.0 BITDI, BITDI 4Motion, TDI, TDI 4Motion [2H]	2,0	90/120	CDBA <D45>; CDCA <D46>	09.10→	DBJ	4	0 445 116 034	0 986 435 369	
Caddy									
2.0 TDI, TDI 4 Motion [2C]	2,0	81/103	CFHC <D91>; CFHE; CFHF; CLCA <D96>	08.10→	DBJ	4	0 445 110 368	0 986 435 166	
Eos									
2.0 TDI [1F7]	2,0	103	CBAB <D91>	05.08-11.10	DBJ	4	0 445 116 029	0 986 435 360	
TDI [1F8]	2,0	100/103	CFFA <D94>; CFFB <D91>	11.10→	DBJ	4	0 445 110 368	0 986 435 166	
Golf Plus									
2.0 TDI [521]	2,0	81/100/103	CBDA <D94>; CBDB <D91>; CBDC <D96>	01.09-05.10	DBJ	4	0 445 116 029	0 986 435 360	
			CFHB <D94>; CFHC <D91>; CLCA <D96>	11.09→	DBJ	4	0 445 110 368	0 986 435 166	



<b>Golf V Variant</b>									
2.0 TDI [1K5]	2,0	100/103	CBDA; CBDB		07.08-07.09	DBJ	4	0 445 116 029	0 986 435 360
<b>Golf VI</b>									
2.0 TDI [5K1]	2,0	103	CJAA <D91>		09.09→	DBJ	4	0 445 116 010	0 986 435 367
TDI, TDI 4 Motion [5K1]	2,0	81/100/103/125	CBAA <D94>; CBAB <D91>; CBBB <D93>; CBDC <D96>		10.08-05.10	DBJ	4	0 445 116 029	0 986 435 360
			CFFA <D94>; CFFB <D91>; CFGB <D93>; CLCA <D96>		11.09→	DBJ	4	0 445 110 368	0 986 435 166
<b>Golf VI Cabrio</b>									
2.0 TDI [517]	2,0	103	CFHC <D91>		11.11→	DBJ	4	0 445 110 368	0 986 435 166
<b>Golf VI Variant</b>									
2.0 TDI [AJ5]	2,0	81/100/100/103	CFHB <D94>; CLCA <D96> CBDA <D91> CBDB <D91> CFHC <D91>		01.10→ 07.09-09.10 07.09→ 07.09→	DBJ DBJ DBJ DBJ	4 4 4 4	0 445 110 368 0 445 116 029 0 445 116 029 0 445 110 368	0 986 435 166 0 986 435 360 0 986 435 360 0 986 435 166
<b>Jetta</b>									
2.0 TDI [1K2]	2,0	81/100/103/125	CLCA <D96> CBDA <D94>; CBDB <D91>; CEGA <D93>		01.10-10.10 07.08-10.10	DBJ DBJ	4 4	0 445 110 368 0 445 116 029	0 986 435 166 0 986 435 360
TDI [162]	2,0	103	CFFB <D91>; CLCB <D91>		10.10→	DBJ	4	0 445 110 368	0 986 435 166
<b>Passat</b>									
2.0 TDI, TDI 4 Motion [3C2]	2,0	81/100/103/105/125	CBAA <D94>; CBAB <D91>; CBAC <D92>; CBBB <D93>; CBDC <D96>		05.08-11.10	DBJ	4	0 445 116 029	0 986 435 360
TDI, TDI 4 Motion [362]	2,0	100/103/125	CFFA <D94>; CFFB <D91>; CFGB <D93>; CLLA		08.10→	DBJ	4	0 445 110 368	0 986 435 166
<b>Passat CC</b>									
2.0 TDI, TDI 4 Motion [357]	2,0	100/103/105/125	CBAA <D94>; CBAB <D91>; CBAC; CBBB <D93>		05.08-11.10	DBJ	4	0 445 116 029	0 986 435 360
		100/103/125	CFFA <D94>; CFFB <D91>; CFGB <D93>		11.10→	DBJ	4	0 445 110 368	0 986 435 166
<b>Passat Variant</b>									
2.0 TDI, TDI 4 Motion [3C5]	2,0	81/100/103/105/125	CBAA <D94>; CBAB <D91>; CBAC <D92>; CBBB <D93>; CBDC <D96>		01.08-11.10	DBJ	4	0 445 116 029	0 986 435 360
TDI, TDI 4 Motion [365]	2,0	100/103/125	CFFA <D94>; CFFB <D91>; CFGB <D93>; CLLA		08.10→	DBJ	4	0 445 110 368	0 986 435 166
<b>Phaeton</b>									
3.0 TDI 4 Motion [3D]	3,0	171/176	CARA; CEXA <D50>		06.07→	DBJ	6	0 445 116 003	0 986 435 378
<b>Scirocco</b>									
2.0 TDI [137]	2,0	100/103/125/103/125	CFGB <D93>; CFHB <D94>; CFHC <D91> CBBB <D93>; CBDB <D91>		11.10→ 10.08-11.10	DBJ DBJ	4 4	0 445 110 368 0 445 116 029	0 986 435 166 0 986 435 360
<b>Sharan</b>									
2.0 TDI, TDI 4 Motion [7N1]	2,0	100/103/125	CFFA <D94>; CFFB <D91>; CFGB <D93>		05.10→	DBJ	4	0 445 110 368	0 986 435 166
<b>Tiguan</b>									
2.0 TDI, TDI 4 Motion [5N1]	2,0	81/100/103/125/100/103/120/125	CFFA <D94>; CFFB <D91>; CFFD <D96>; CFGB <D93>; CLJA <D91> CBAA <D94>; CBAB <D91>; CBBA <D95>; CBBB <D93>		11.09-05.11 11.07-05.11	DBJ DBJ	4 4	0 445 110 368 0 445 116 029	0 986 435 166 0 986 435 360
<b>Touareg</b>									
3.0 TDI [7L6]	3,0	155/176/165	CASA; CASB; CASC CATA		11.07-05.10 05.09-05.10	DBJ DBJ	6 6	0 445 116 022 0 445 117 004	0 986 435 357 0 986 435 382
TDI [7P5]	3,0	150/176/150/180	CASA <D50>; CASD <D1Q> CJMA; CRCA		01.10-05.11 05.11→	DBJ DBJ	6 6	0 445 116 022 0 445 117 021	0 986 435 357
<b>Touran</b>									
2.0 TDI [1T3]	2,0	81/103/125	CFHC <D91>; CFJA <D93>; CLCA <D96>		05.10→	DBJ	4	0 445 110 368	0 986 435 166





**AMUR (AUTOM.AND MOTOR OF URAL)**

10t							
531320	4,8	100	D 245.9 E3 <Euro 3>	01.08→	DBJ	4	0 445 120 141
11t							
341240	4,8	111,4	D 245.30 E3 <Euro 3>	04.09→	DBJ	4	0 445 120 141
541340	4,8	111,4	D 245.30 E3 <Euro 3>	04.09→	DBJ	4	0 445 120 141

**BAW**

Fenix							
1044	3,2	76	CA4DC2-10E3 <Euro 3>	04.08→	DBJ	4	0 445 110 291
1065	3,2	88	CA4DC2-12E3 <Euro 3>	04.08→	DBJ	4	0 445 110 291

**CITROEN**

Jumper							
2.0 HDi [U5]	2,0	62	RHV <DW10TD>	02.02-05.06	DBB	4	0 445 110 076 0 986 435 077
HDi [23]	2,0	62	RHV <DW10TD>	03.01-02.02	DBB	4	0 445 110 076 0 986 435 077
2.2 HDi [U5]	2,2	74	4HY <DW12TED>	02.02-05.06	DBB	4	0 445 110 076 0 986 435 077
2.8 HDi [U5]	2,8	94/107	8140 43N <SOFIM 2800 HDi>; 8140 43s <SOFIM 2800 HDi>	02.02-05.06	DBJ	4	0 445 120 002 0 986 435 501
HDi [23]	2,8	94	8140 43s <SOFIM 2800 HDi>	09.00-02.02	DBJ	4	0 445 120 002 0 986 435 501
HDI	2,8	93	8140 43s	09.05-09.09	DBJ	4	0 445 120 002 0 986 435 501

**DAF**

CF							
65 .180, .220, .250	5,9	136/162/184	CE 136 <Euro3>; CE 162 <Euro3>; CE 184 C <Euro3>	01.01-01.07	DBJ	6	0 445 120 212 0 986 435 508
.220, .250	6,7	165/184	GR 165 <Euro 4/5/EEV>; GR 184 <Euro 4/5>	04.06→	DBJ,TW	6	0 445 120 060 0 986 435 533
.280	6,7	210	GR 210 <Euro 4>	04.07→	DBJ	6	0 445 120 060 0 986 435 533
LF							
45 .130, .180	5,9	99/136	BE 99 <Euro 3>; CE 136 C <Euro 3>	07.01-12.08	DBJ	6	0 445 120 212 0 986 435 508
.140, .160, .180	4,5	103/118/136	FR 103 <Euro 4/5>; FR 118 <Euro 4/5>; FR 136 <Euro 4/5>	05.06→	DBJ,TW	4	0 445 120 060 0 986 435 533
.150	3,9	110	BE 110 C <Euro 3>	04.01-10.07	DBJ	6	0 445 120 212 0 986 435 508
.170	3,9	123	BE 123 C <Euro 3>	04.01-12.07	DBJ,TW	6	0 445 120 060 0 986 435 533
.220	5,9	162	CE 162 C <Euro 3>	11.01-01.09	DBJ,TW	6	0 445 120 060 0 986 435 533
.220, .250	6,7	165/184	GR 165 <Euro 4/5>; GR 184 <Euro 4/5>	09.06→	DBJ,TW	6	0 445 120 060 0 986 435 533
55							
.180	4,5	136	FR 136 <Euro 4/5>	04.06→	DBJ,TW	4	0 445 120 060 0 986 435 533
.220	5,9	136	CE 136 C	04.01-08.08	DBJ	6	0 445 120 212 0 986 435 508
.220	5,9	162	CE 162 C	04.01-08.08	DBJ,TW	6	0 445 120 060 0 986 435 533
.220, .250, .280	6,7	165/184/210	GR 165 <Euro 4/5>; GR 184 <Euro 4/5>; GR 210 <Euro 4/5>	04.06→	DBJ,TW	4	0 445 120 060 0 986 435 533
.250	5,9	184	CE 184 C	04.01-08.08	DBJ,TW	6	0 445 120 060 0 986 435 533
						6	0 445 120 212 0 986 435 508

**DODGE**

Sprinter 2500							
2.7 [VA]	2,7	115	OM 612	01.03-12.03	DBB	5	0 445 110 181 0 986 435 053
3.0 CDI [VB]	3,0	115	EXM	09.06-08.08	DBB	6	0 445 115 061







FIAT

Ducato									
2.3 JTD [250..]	2,3	96/109		06.11→	DBJ	4	0 445 110 418		
3.0 JTD [250..]	3,0	130	F1CE3481E	06.11→	DBJ	4	0 445 116 019		
Ducato Cargo									
2.8 JTD	2,8	93	8140.43S	06.05-08.09	DBJ	4	0 445 120 002	0 986 435 501	
Ducato Combinato									
2.8 JTD	2,8	93	8140.43S	06.05-08.09	DBJ	4	0 445 120 002	0 986 435 501	
Ducato Minibus									
2.8 JTD	2,8	93	8140.43S	06.05-08.09	DBJ	4	0 445 120 002	0 986 435 501	
Ducato Multi									
2.8 JTD	2,8	93	8140.43S	06.05-08.09	DBJ	4	0 445 120 002	0 986 435 501	
Ducato 10									
2.8 JTD EGR 4x4, JTD 4x4 [234..]	2,8	94	8140.43S <M13>; 8140.43S <M14>	08.00-03.02	DBJ	4	0 445 120 002	0 986 435 501	
JTD, JTD EGR [230..]	2,8	94	8140.43S <M13>; 8140.43S <M14>	08.00-03.02	DBJ	4	0 445 120 002	0 986 435 501	
Ducato 11									
2.0 JTD [243..]	2,0	62	RHV <M5>	04.02-08.06	DBB,KKY	4	0 445 110 076	0 986 435 077	
2.3 JTD [243..]	2,3	81	F1AE0481C <M10>	04.02-08.06	DBJ	4	0 445 120 011	0 986 435 506	
				01.08→	DBJ	4	0 445 110 273	0 986 435 165	
JTD [250..]	2,3	88/96	F1AE0481D <M94>; F1AE0481N <M95>	06.06→	DBJ	4	0 445 110 273	0 986 435 165	
JTD EGR [243..]	2,3	81	F1AE0481C <M11>	04.02-08.06	DBJ	4	0 445 120 011	0 986 435 506	
2.8 JTD EGR 4x4, JTD 4x4 [247..]	2,8	94	8140.43S <M15>; 8140.43S <M20>	04.02-08.06	DBJ	4	0 445 120 002	0 986 435 501	
JTD, JTD EGR [243..]	2,8	94	8140.43S <M15>; 8140.43S <M20>	04.02-08.06	DBJ	4	0 445 120 002	0 986 435 501	
3.0 JTD [250..]	3,0	116	F1CE0481D <M96>	06.06→	DBJ	4	0 445 110 248	0 986 435 163	
Ducato 14									
2.8 JTD EGR 4x4, JTD 4x4 [234..]	2,8	94	8140.43S <M13>; 8140.43S <M14>	08.00-03.02	DBJ	4	0 445 120 002	0 986 435 501	
JTD, JTD EGR [231..]	2,8	94	8140.43S <M13>; 8140.43S <M14>	08.00-03.02	DBJ	4	0 445 120 002	0 986 435 501	
Ducato 15									
2.0 JTD [244..]	2,0	62	RHV <M5>	04.02-08.06	DBB,KKY	4	0 445 110 076	0 986 435 077	
2.3 JTD [244..]	2,3	81	F1AE0481C <M10>	04.02-08.06	DBJ	4	0 445 120 011	0 986 435 506	
				01.08→	DBJ	4	0 445 110 273	0 986 435 165	
JTD [250..]	2,3	88/96	F1AE0481D <M94>; F1AE0481N <M95>	06.06→	DBJ	4	0 445 110 273	0 986 435 165	
JTD EGR [244..]	2,3	81	F1AE0481C <M11>	04.02-08.06	DBJ	4	0 445 120 011	0 986 435 506	
				01.08→	DBJ	4	0 445 110 273	0 986 435 165	
2.8 JTD EGR 4x4, JTD 4x4 [247..]	2,8	94	8140.43S <M15>; 8140.43S <M20>	04.02-08.06	DBJ	4	0 445 120 002	0 986 435 501	
JTD, JTD CGV, JTD EGR [244..]	2,8	94/107	8140.43S <M15>; 8140.43S <M20>; 8140.43S <M22>	04.02-08.06	DBJ	4	0 445 120 002	0 986 435 501	
3.0 JTD [250..]	3,0	116	F1CE0481D <M96>	06.06→	DBJ	4	0 445 110 248	0 986 435 163	
Ducato 17									
2.3 JTD [250..]	2,3	88/96	F1AE0481D <M94>; F1AE0481N <M95>	06.06→	DBJ	4	0 445 110 273	0 986 435 165	
JTD Maxi [251..]	2,3	88/96	F1AE0481D <M94>; F1AE0481N <M95>	06.06→	DBJ	4	0 445 110 273	0 986 435 165	
3.0 JTD [250..]	3,0	116	F1CE0481D <M96>	06.06→	DBJ	4	0 445 110 248	0 986 435 163	
JTD Maxi [251..]	3,0	116	F1CE0481D <M96>	06.06→	DBJ	4	0 445 110 248	0 986 435 163	
Ducato 18									
2.3 JTD [245..]	2,3	81	F1AE0481C <M10>	04.02-08.06	DBJ	4	0 445 120 011	0 986 435 506	
				01.08→	DBJ	4	0 445 110 273	0 986 435 165	
JTD EGR [245..]	2,3	81	F1AE0481C <M11>	01.08→	DBJ	4	0 445 110 273	0 986 435 165	
2.8 JTD EGR 4x4, JTD 4x4 [234..]	2,8	94	8140.43S <M13>; 8140.43S <M14>	08.00-03.02	DBJ	4	0 445 120 002	0 986 435 501	
JTD EGR 4x4, JTD 4x4 [247..]	2,8	94	8140.43S <M15>; 8140.43S <M20>	04.02-08.06	DBJ	4	0 445 120 002	0 986 435 501	
JTD, JTD CGV, JTD EGR [245..]	2,8	94/107	8140.43S <M15>; 8140.43S <M20>; 8140.43S <M22>	04.02-08.06	DBJ	4	0 445 120 002	0 986 435 501	
JTD, JTD EGR [232..]	2,8	94	8140.43S <M13>; 8140.43S <M14>	08.00-03.02	DBJ	4	0 445 120 002	0 986 435 501	
Ducato 20									
2.3 JTD Maxi [251..]	2,3	88/96	F1AE0481D <M94>; F1AE0481N <M95>	06.06→	DBJ	4	0 445 110 273	0 986 435 165	
3.0 JTD [251..]	3,0	107/115	F1CE3481M <M99>; F1CE3481N <M97>	09.10→	DBJ	4	0 445 116 019		
JTD Maxi [251..]	3,0	116	F1CE0481D <M96>	06.06→	DBJ	4	0 445 110 248	0 986 435 163	





**FORD**

Cargo Ford-Otosan							
Cargo 1830, 2524, 2530, 3230	0,0	177/221	ECOTORQ 240 <Euro 3>; ECOTORQ 300 <Euro 3>	08.03-11.06	DBJ	0	<b>0 445 120 025</b>
Serie F							
250 4x4	3,9	149	4BTAA <MaxPower>	04.06-02.12	DBJ	4	<b>0 445 120 212 0 986 435 508</b>

**GALICH CRANE PLANT**

50t							
KS-64713-2	11,1	303	650.10 <Euro 3>	01.10→	DBJ	6	<b>0 445 120 142</b>

**GAZ**

Gazel							
2.7 TD	2,7	80	ADCR110 <Euro 4>	01.07→	DBJ	4	<b>0 445 110 312</b>
2.8 TD	2,8	88,3/102,7	ISF 2.8s3129T <Euro 3>; ISF 2.8s3148T <Euro 3>	08.10→	DBJ	4	<b>0 445 110 376</b>
Sadko							
4.8 TD 4x4	4,8	90	D 245.7 E3 <Euro 3>	01.08→	DBJ	4	<b>0 445 120 141</b>
			D 245.7 E4 <Euro 4>	12.11→	DBJ	4	<b>0 445 120 245</b>
Sobol							
2.8 TD	2,8	88,3/102,7	ISF 2.8s3129T <Euro 3>; ISF 2.8s3148T <Euro 3>	08.10→	DBJ	4	<b>0 445 110 376</b>
Valday							
3.8 TD	3,8	125	ISF 3.8 <Euro 3>	12.11→	DBJ	4	<b>0 445 120 134</b>
4.8 TD	4,8	90	D 245.7 E3 <Euro 3>	01.08→	DBJ	4	<b>0 445 120 141</b>
			D 245.7 E4 <Euro 4>	12.11→	DBJ	4	<b>0 445 120 245</b>
3309							
4.8 TD	4,8	90	D 245.7 E3 <Euro 3>	01.08→	DBJ	4	<b>0 445 120 141</b>
			D 245.7 E4 <Euro 4>	12.11→	DBJ	4	<b>0 445 120 245</b>

**GMC (GENERAL MOTORS CORP.)**

Savana 3500							
6.6	6,6	187	LLY	09.05-08.06	DBJ	8	<b>0 445 120 042 0 986 435 521</b>
				09.06-08.07	DBJ	8	<b>0 445 120 082</b>

**HYUNDAI**

H 100							
2.5 CRDi	2,5	92	D4CB <2.5L-A>	01.09→	DBJ	4	<b>0 445 110 277</b>
H-1							
2.5 CRDi	2,5	103	D4CB	08.03-12.06	DBJ,OKN	4	<b>0 445 110 091 0 986 435 154</b>
CRDi Cargo, CRDi Travel	2,5	81-85/100/125	D4CB <2.5L A>; D4CB <2.5L A/2.5L A2>	03.08→	DBJ,TW	4	<b>0 445 110 274</b>
						4	<b>0 445 110 277</b>
Starex							
2.5 CRDi	2,5	103	D4CB	10.02-01.07	DBJ,TW	4	<b>0 445 110 091 0 986 435 154</b>
						4	<b>0 445 110 279</b>
		107	<A2,51Gen>	12.02-11.03	DBJ	4	<b>0 445 110 091 0 986 435 154</b>
				12.03→	DBJ	4	<b>0 445 110 279</b>





IVECO

CityClass									
<b>2.8</b>	2,8	92	8140.43S		10.05-07.07	<del>DBJ</del>	4	<b>0 445 120 002</b>	<b>0 986 435 501</b>
<b>Daily</b>									
<b>29 L 9, 13 [00]</b>	2,8	66/92	8140.43R.43...; 8140.43S...		10.00-03.06	<del>DBJ</del>	4	<b>0 445 120 002</b>	<b>0 986 435 501</b>
10 [06]	2,3	71	F1AE0481F...						
			Fg.Nr. →1303265		04.06→	<del>DBJ</del>	4	<b>0 445 110 273</b>	<b>0 986 435 165</b>
			Fg.Nr. 1303266→		04.06→	DBJ	4	<b>0 445 110 435</b>	
10, 12, 14 [00]	2,3	70/85/ 100	F1AE0481A...; F1AE0481B...; F1AE0481M...		09.02-03.06	<del>DBJ</del>	4	<b>0 445 120 011</b>	<b>0 986 435 506</b>
12 [06]	2,3	85	F1AE0481G...						
			Fg.Nr. →1303265		04.06→	<del>DBJ</del>	4	<b>0 445 110 273</b>	<b>0 986 435 165</b>
			Fg.Nr. 1303266→		04.06→	DBJ	4	<b>0 445 110 435</b>	
14 [06]	2,3	100	F1AE0481H...						
			Fg.Nr. →1303265		04.06→	<del>DBJ</del>	4	<b>0 445 110 273</b>	<b>0 986 435 165</b>
			Fg.Nr. 1303266→		04.06→	DBJ	4	<b>0 445 110 435</b>	
<b>35 C 9, 11, 13, 15 [00]</b>	2,8	66/78/ 92/108	8140.43B.43...; 8140.43N.43...; 8140.43R...; 8140.43S...		05.99-09.04	<del>DBJ</del>	4	<b>0 445 120 002</b>	<b>0 986 435 501</b>
10 [06]	2,3	71	F1AE0481F...						
			Fg.Nr. →1303265		04.06-05.09	<del>DBJ</del>	4	<b>0 445 110 273</b>	<b>0 986 435 165</b>
			Fg.Nr. 1303266→		04.06-05.09	DBJ	4	<b>0 445 110 435</b>	
10, 12, 14 [00]	2,3	70/85/ 100	F1AE0481A*A...; F1AE0481B...; F1AE0481M...		09.02-03.06	<del>DBJ</del>	4	<b>0 445 120 011</b>	<b>0 986 435 506</b>
11 [09]	2,3	78	F1AE0481U...						
			Fg.Nr. →1303265		06.09→	<del>DBJ</del>	4	<b>0 445 110 273</b>	<b>0 986 435 165</b>
			Fg.Nr. 1303266→		06.09→	DBJ	4	<b>0 445 110 435</b>	
12 [06]	2,3	85	F1AE0481G...						
			Fg.Nr. →1303265		04.06→	<del>DBJ</del>	4	<b>0 445 110 273</b>	<b>0 986 435 165</b>
			Fg.Nr. 1303266→		04.06→	DBJ	4	<b>0 445 110 435</b>	
			F1AE0481R...						
			Fg.Nr. →1303265		04.06→	<del>DBJ</del>	4	<b>0 445 110 273</b>	<b>0 986 435 165</b>
			Fg.Nr. 1303266→		04.06→	DBJ	4	<b>0 445 110 435</b>	
13 [09]	2,3	93	F1AE0481V...						
			Fg.Nr. →1303265		06.09→	<del>DBJ</del>	4	<b>0 445 110 273</b>	<b>0 986 435 165</b>
			Fg.Nr. 1303266→		06.09→	DBJ	4	<b>0 445 110 435</b>	
14 [06]	2,3	85	F1AE0481G...		04.06-05.09	<del>DBJ</del>	4	<b>0 445 110 273</b>	<b>0 986 435 165</b>
		100	F1AE0481H...						
			Fg.Nr. →1303265		04.06-05.09	<del>DBJ</del>	4	<b>0 445 110 273</b>	<b>0 986 435 165</b>
			Fg.Nr. 1303266→		04.06-05.09	DBJ	4	<b>0 445 110 435</b>	
14, 17 [00]	3,0	100/122	F1CE0481A...; F1CE0481B...		09.04-03.06	<del>DBJ</del>	4	<b>0 445 120 036</b>	<b>0 986 435 507</b>
14, 17 [09]	3,0	103/125	F1CE3481C...; F1CE3481L...		06.09→	<del>DBJ</del>	4	<b>0 445 116 019</b>	
15, 18 [06]	3,0	107/130	F1CE0481F...; F1CE0481H...		04.06→	<del>DBJ</del>	4	<b>0 445 110 248</b>	<b>0 986 435 163</b>
<b>35 S 9, 11, 13, 15 [00]</b>	2,8	66/78/ 92/108	8140.43B.43...; 8140.43N.43...; 8140.43R...; 8140.43S...		05.99-09.06	<del>DBJ</del>	4	<b>0 445 120 002</b>	<b>0 986 435 501</b>
10 [06]	2,3	71	F1AE0481F...						
			Fg.Nr. →1303265		04.06→	<del>DBJ</del>	4	<b>0 445 110 273</b>	<b>0 986 435 165</b>
			Fg.Nr. 1303266→		04.06→	DBJ	4	<b>0 445 110 435</b>	
10, 12, 14 [00]	2,3	70/85/ 100	F1AE0481A...; F1AE0481B...; F1AE0481M...		09.02-03.06	<del>DBJ</del>	4	<b>0 445 120 011</b>	<b>0 986 435 506</b>
11 [09]	2,3	78	F1AE0481U...						
			Fg.Nr. →1303265		06.09→	<del>DBJ</del>	4	<b>0 445 110 273</b>	<b>0 986 435 165</b>
			Fg.Nr. 1303266→		06.09→	DBJ	4	<b>0 445 110 435</b>	
12 [06]	2,3	85	F1AE0481G...						
			Fg.Nr. →1303265		04.06-05.09	<del>DBJ</del>	4	<b>0 445 110 273</b>	<b>0 986 435 165</b>
			Fg.Nr. 1303266→		04.06-05.09	DBJ	4	<b>0 445 110 435</b>	
			F1AE0481R...						
			Fg.Nr. →1303265		04.06→	<del>DBJ</del>	4	<b>0 445 110 273</b>	<b>0 986 435 165</b>
			Fg.Nr. 1303266→		04.06→	DBJ	4	<b>0 445 110 435</b>	
13 [09]	2,3	93	F1AE0481V...						
			Fg.Nr. →1303265		06.09→	<del>DBJ</del>	4	<b>0 445 110 273</b>	<b>0 986 435 165</b>
			Fg.Nr. 1303266→		06.09→	DBJ	4	<b>0 445 110 435</b>	





◀ IVECO

<b>35 S 14 [06]</b>	2,3	100	F1AE0481H...								
			Fg.Nr. →1303265	04.06→	DBJ	4	0 445 110 273	0 986 435 165			
			Fg.Nr. 1303266→	04.06→	DBJ	4	0 445 110 435				
14, 17 [00]	3,0	100/122	F1CE0481A...; F1CE0481B...	09.04-03.06	DBJ	4	0 445 120 036	0 986 435 507			
14, 17 [09]	3,0	103/125	F1CE3481C...; F1CE3481L...	06.09→	DBJ	4	0 445 116 019				
15, 18 [06]	3,0	107/130	F1CE0481F...; F1CE0481H...	04.06-05.09	DBJ	4	0 445 110 248	0 986 435 163			
18 [09]	3,0	130	F1CE3481H...	11.10→	DBJ	4	0 445 110 248	0 986 435 163			
<b>40 C 10 [06]</b>	2,3	71	F1AE0481F...								
			Fg.Nr. →1303265	04.06-05.09	DBJ	4	0 445 110 273	0 986 435 165			
			Fg.Nr. 1303266→	04.06-05.09	DBJ	4	0 445 110 435				
11 [09]	2,3	78	F1AE0481U...								
			Fg.Nr. →1303265	06.09→	DBJ	4	0 445 110 273	0 986 435 165			
			Fg.Nr. 1303266→	06.09→	DBJ	4	0 445 110 435				
12 [06]	2,3	85	F1AE0481G...								
			Fg.Nr. →1303265	04.06-05.09	DBJ	4	0 445 110 273	0 986 435 165			
			Fg.Nr. 1303266→	04.06-05.09	DBJ	4	0 445 110 435				
13 [09]	2,3	93	F1AE0481V...								
			Fg.Nr. →1303265	06.09→	DBJ	4	0 445 110 273	0 986 435 165			
			Fg.Nr. 1303266→	06.09→	DBJ	4	0 445 110 435				
13, 15 [00]	2,8	92/108	8140.43N.43...; 8140.43S...	01.01-09.04	DBJ	4	0 445 120 002	0 986 435 501			
14, 17 [00]	3,0	100/122	F1CE0481A...; F1CE0481B...	09.04-03.06	DBJ	4	0 445 120 036	0 986 435 507			
14, 17 [09]	3,0	103/125	F1CE3481C...; F1CE3481CC...	06.09→	DBJ	4	0 445 116 019				
15, 18 [06]	3,0	107/130	F1CE0481...; F1CE0481H...	04.06→	DBJ	4	0 445 110 248	0 986 435 163			
<b>45 C 13 [00]</b>	2,8	92	8140.43S...	01.01-09.04	DBJ	4	0 445 120 002	0 986 435 501			
15, 18 [06]	3,0	107/130	F1CE0481F...; F1CE0481H...	04.06→	DBJ	4	0 445 110 248	0 986 435 163			
<b>50 C 11, 13, 15 [00]</b>	2,8	78/92/108	8140.43B.43...; 8140.43N.43...; 8140.43S...	05.99-09.04	DBJ	4	0 445 120 002	0 986 435 501			
12 [00]	2,3	85	F1AE0481B...	09.02-03.06	DBJ	4	0 445 120 011	0 986 435 506			
12 [06]	2,3	85	F1AE0481G...	04.06→	DBJ	4	0 445 110 273	0 986 435 165			
14, 17 [00]	3,0	100/122	F1CE0481A...; F1CE0481B...	09.04-03.06	DBJ	4	0 445 120 036	0 986 435 507			
14, 17 [09]	3,0	103/125	F1CE3481C...; F1CE3481L...	06.09→	DBJ	4	0 445 116 019				
15, 18 [06]	3,0	107/130	F1CE0481F...; F1CE0481H...	04.06→	DBJ	4	0 445 110 248	0 986 435 163			
<b>55 S 17 [09]</b>	3,0	125	F1CE3481CC...	06.09→	DBJ	4	0 445 116 019				
18 [06]	3,0	130	F1CE0481H...	04.06→	DBJ	4	0 445 110 248	0 986 435 163			
<b>60 C 15, 18 [06]</b>	3,0	107/130	F1CE0481F...; F1CE0481H...	04.06→	DBJ	4	0 445 110 248	0 986 435 163			
<b>65 C 13, 15 [00]</b>	2,8	108	8140.43N.43...	05.00-09.04	DBJ	4	0 445 120 002	0 986 435 501			
14 [00]	3,0	100	F1CE0481A...	09.04-03.06	DBJ	4	0 445 120 036	0 986 435 507			
14, 17 [09]	3,0	103/125	F1CE3481C...; F1CE3481L...	06.09→	DBJ	4	0 445 116 019				
15, 18 [06]	3,0	107/130	F1CE0481F...; F1CE0481H...	04.06→	DBJ	4	0 445 110 248	0 986 435 163			
<b>70 C 14, 17 [09]</b>	3,0	103/125	F1CE3481C...; F1CE3481L...	11.10→	DBJ	4	0 445 116 019				
15, 18 [09]	3,0	107/130	F1CE3481F...; F1CE3481H...	06.10→	DBJ	4	0 445 110 248	0 986 435 163			
<b>Daily Chassi</b>											
<b>35 .13</b>	2,8	92	8140.43S	10.05-07.07	DBJ	4	0 445 120 002	0 986 435 501			
<b>35 S 14</b>	3,0	100	F1CE0481 <Euro 3>	08.07→	DBJ	4	0 445 110 248	0 986 435 163			
<b>40 .13</b>	2,8	92	8140.43S	10.05-07.07	DBJ	4	0 445 120 002	0 986 435 501			
<b>50 .13</b>	2,8	92	8140.43S	10.05-07.07	DBJ	4	0 445 120 002	0 986 435 501			
<b>55 C 16</b>	3,0	114	F1CE0481 <Euro 3>	08.07→	DBJ	4	0 445 110 248	0 986 435 163			
<b>70 .13</b>	2,8	92	8140.43S	10.05-07.07	DBJ	4	0 445 120 002	0 986 435 501			
<b>Daily Furgao</b>											
<b>35 S 14</b>	3,0	100	F1CE0481 <Euro 3>	08.07→	DBJ	4	0 445 110 248	0 986 435 163			
<b>38 .13</b>	2,8	92	8140.43S	10.05-07.07	DBJ	4	0 445 120 002	0 986 435 501			
<b>40 .13</b>	2,8	92	8140.43S	10.05-07.07	DBJ	4	0 445 120 002	0 986 435 501			
<b>50 .13</b>	2,8	92	8140.43S	10.05-07.07	DBJ	4	0 445 120 002	0 986 435 501			
<b>55 C 16</b>	3,0	114	F1CE0481 <Euro 3>	08.07→	DBJ	4	0 445 110 248	0 986 435 163			
<b>Daily MaxiVan</b>											
<b>40 .13</b>	2,8	92	8140.43S	10.05-07.07	DBJ	4	0 445 120 002	0 986 435 501			
<b>40 S 16</b>	3,0	114	F1CE0481 <Euro 3>	08.07→	DBJ	4	0 445 110 248	0 986 435 163			
<b>55 C 16</b>	3,0	114	F1CE0481 <Euro 3>	08.07→	DBJ	4	0 445 110 248	0 986 435 163			
<b>EuroCargo</b>											
<b>65 E 13, 15</b>	3,9	95/110	F4AE0481C*...; F4AE0481D*C...	08.00-08.03	DBJ	4	0 445 120 212	0 986 435 508			
13, 15 [03]	3,9	95/110	F4AE0481C*...; F4AE0481D*C...	09.03-08.05	DBJ	4	0 445 120 212	0 986 435 508			
14, 16 [03]	3,9	103/118	F4AE3481C*P...; F4AE3481D*P...	09.04-08.06	DBJ	4	0 445 120 054				





<b>75 E</b> 13, 15, 17	3,9	95/110/125	F4AE0481A*C...; F4AE0481C...; F4AE0481D...	09.00-08.03	DBJ	4	<b>0 445 120 212</b>	<b>0 986 435 508</b>
13, 15, 17 [03]	3,9	95/110/125	F4AE0481A*C...; F4AE0481C...; F4AE0481D...	09.03-08.05	DBJ	4	<b>0 445 120 212</b>	<b>0 986 435 508</b>
14, 16, 18 [03]	3,9	103/118/130	F4AE3481B*...; F4AE3481C...; F4AE3481D...	09.05→	DBJ	4	<b>0 445 120 054</b>	
18	5,9	134	F4AE0681E*C...	09.00-08.03	DBJ	6	<b>0 445 120 212</b>	<b>0 986 435 508</b>
18 [03]	5,9	134	F4AE0681E*C...	09.03-08.05	DBJ	6	<b>0 445 120 212</b>	<b>0 986 435 508</b>
<b>80 E</b> 15, 17	3,9	110/125	F4AE0481A*C...; F4AE0481C...	09.00-08.03	DBJ	4	<b>0 445 120 212</b>	<b>0 986 435 508</b>
15, 17 [03]	3,9	110/125	F4AE0481A*C...; F4AE0481C...	09.03-08.05	DBJ	4	<b>0 445 120 212</b>	<b>0 986 435 508</b>
16, 18 [03]	3,9	118/130	F4AE3481B...; F4AE3481D...	09.05→	DBJ	4	<b>0 445 120 054</b>	
18, 21	5,9	134/154	F4AE0681D*C...; F4AE0681E*C...	09.00-08.03	DBJ	6	<b>0 445 120 212</b>	<b>0 986 435 508</b>
18, 21 [03]	5,9	134/154	F4AE0681D*C...; F4AE0681E*C...	09.03-08.05	DBJ	6	<b>0 445 120 212</b>	<b>0 986 435 508</b>
22 [03]	5,9	160	F4AE3681B...	09.05→	DBJ	6	<b>0 445 120 054</b>	
<b>90 E</b> 17	3,9	125	F4AE0481A*C...	09.00-08.03	DBJ	4	<b>0 445 120 212</b>	<b>0 986 435 508</b>
17 [03]	3,9	125	F4AE0481A*C...	09.03-09.05	DBJ	4	<b>0 445 120 212</b>	<b>0 986 435 508</b>
18 [03]	3,9	130	F4AE3481B...	09.05→	DBJ	4	<b>0 445 120 054</b>	
18, 21	5,9	134/154	F4AE0681D*C...; F4AE0681E*C...	09.00-08.03	DBJ	6	<b>0 445 120 212</b>	<b>0 986 435 508</b>
18, 21 [03]	5,9	134/154	F4AE0681D*C...; F4AE0681E*C...	09.03-09.05	DBJ	6	<b>0 445 120 212</b>	<b>0 986 435 508</b>
22 [03]	5,9	160	F4AE3681B*...	09.05→	DBJ	6	<b>0 445 120 054</b>	
<b>100 E</b> 17	3,9	125	F4AE0481A*C...	09.00-08.03	DBJ	4	<b>0 445 120 212</b>	<b>0 986 435 508</b>
17 [03]	3,9	125	F4AE0481A*C...	09.03-08.05	DBJ	4	<b>0 445 120 212</b>	<b>0 986 435 508</b>
18 [03]	3,9	130	F4AE3481B...	09.06→	DBJ	4	<b>0 445 120 054</b>	
18, 21	5,9	134/154	F4AE0681D*C...; F4AE0681E*C...	09.00-08.03	DBJ	6	<b>0 445 120 212</b>	<b>0 986 435 508</b>
18, 21 [03]	5,9	134/154	F4AE0681D*C...; F4AE0681E*C...	09.03-08.05	DBJ	6	<b>0 445 120 212</b>	<b>0 986 435 508</b>
18, 22 [03]	5,9	135/160	F4AE3681B...; F4AE3681C*...	09.05→	DBJ	6	<b>0 445 120 054</b>	
<b>110 E</b> 22, 25 [03]	5,9	160/185	F4AE3681B...; F4AE3681D*...	09.07→	DBJ	6	<b>0 445 120 054</b>	
<b>120 E</b> 17	3,9	125	F4AE0481A*C...	09.00-08.03	DBJ	4	<b>0 445 120 212</b>	<b>0 986 435 508</b>
17 [03]	3,9	125	F4AE0481A*C...	09.03-08.05	DBJ	4	<b>0 445 120 212</b>	<b>0 986 435 508</b>
18 [03]	3,9	134	F4AE3481A...	09.05→	DBJ	4	<b>0 445 120 054</b>	
18, 21, 24, 28	5,9	134/154/176/202	F4AE0681A*C...; F4AE0681B*C...; F4AE0681D*C...; F4AE0681E*C...	09.00-08.03	DBJ	6	<b>0 445 120 212</b>	<b>0 986 435 508</b>
18, 21, 24, 28 [03]	5,9	134/154/176/202	F4AE0681A*C...; F4AE0681B*C...; F4AE0681D*C...; F4AE0681E*C...	09.03-08.05	DBJ	6	<b>0 445 120 212</b>	<b>0 986 435 508</b>
22, 25, 28 [03]	5,9	160/185/205	F4AE3681B...; F4AE3681D...; F4AE3681E...	09.05→	DBJ	6	<b>0 445 120 054</b>	
<b>120 EL</b> 18 [03]	3,9	130	F4AE3481B*P...	09.05→	DBJ	4	<b>0 445 120 054</b>	
22 [03]	5,9	160	F4AE3681B...	05.09→	DBJ	6	<b>0 445 120 054</b>	
<b>130 E</b> 18 [03]	3,9	134	F4AE3481A*P...	09.05→	DBJ	4	<b>0 445 120 054</b>	
18, 21, 24, 28	5,9	134/154/176/202	F4AE0681A*C...; F4AE0681B*C...; F4AE0681D*C...; F4AE0681E*C...	09.00-08.03	DBJ	6	<b>0 445 120 212</b>	<b>0 986 435 508</b>
18, 21, 24, 28 [03]	5,9	134/154/176/202	F4AE0681A*C...; F4AE0681B*C...; F4AE0681D*C...; F4AE0681E*C...	09.03-08.05	DBJ	6	<b>0 445 120 212</b>	<b>0 986 435 508</b>
25 [03]	5,9	185	F4AE3681D*...	09.05→	DBJ	6	<b>0 445 120 054</b>	
<b>140 E</b> 18 [03]	3,9	134	F4AE3481A...	09.05→	DBJ	4	<b>0 445 120 054</b>	
18, 21, 24	5,9	134/154/176	F4AE0681B*C...; F4AE0681D*C...; F4AE0681E*C...	09.00-08.05	DBJ	6	<b>0 445 120 212</b>	<b>0 986 435 508</b>
18, 24, 28 [03]	5,9	134/176/202	F4AE0681A*C...; F4AE0681B*C...; F4AE0681E*C...	09.03-08.05	DBJ	6	<b>0 445 120 212</b>	<b>0 986 435 508</b>
22, 25, 28 [03]	5,9	160/185/205	F4AE3681B...; F4AE3681D...; F4AE3681E...	09.05→	DBJ	6	<b>0 445 120 054</b>	
<b>150 E</b> 18 [03]	3,9	134	F4AE3481A*...	09.05→	DBJ	4	<b>0 445 120 054</b>	
18, 21, 24, 28	5,9	134/154/176/202	F4AE0681A*C...; F4AE0681B*C...; F4AE0681D*C...; F4AE0681E*C...	09.00-08.03	DBJ	6	<b>0 445 120 212</b>	<b>0 986 435 508</b>
18, 21, 24, 28 [03]	5,9	134/154/176/202	F4AE0681A*C...; F4AE0681B*C...; F4AE0681D*C...; F4AE0681E*C...	09.03-08.05	DBJ	6	<b>0 445 120 212</b>	<b>0 986 435 508</b>
22, 25, 28, 30 [03]	5,9	160/185/205/220	F4AE3681A*...; F4AE3681B*...; F4AE3681D*...; F4AE3681E*...	09.05→	DBJ	6	<b>0 445 120 054</b>	
<b>160 E</b> 18 [03]	3,9	134	F4AE3481A*...	09.05→	DBJ	4	<b>0 445 120 054</b>	
21, 24, 28 [03]	5,9	154/176/202	F4AE0681A*C...; F4AE0681B*C...; F4AE0681D*C...	09.03-08.05	DBJ	6	<b>0 445 120 212</b>	<b>0 986 435 508</b>
22, 25, 28, 30 [03]	5,9	160/185/205/220	F4AE3681A*...; F4AE3681B*...; F4AE3681D*...; F4AE3681E*...	09.05→	DBJ	6	<b>0 445 120 054</b>	





◀ IVECO

<b>180 E</b> 21, 24, 28	5,9	154/176/202	F4AE0681A*C...; F4AE0681B*C...; F4AE0681D*C...	09.00-08.03	DBJ	6	<b>0 445 120 212</b>	<b>0 986 435 508</b>
21, 24, 28 [03]	5,9	154/176/202	F4AE0681A*C...; F4AE0681B*C...; F4AE0681D*C...	09.03-08.05	DBJ	6	<b>0 445 120 212</b>	<b>0 986 435 508</b>
25, 28, 30 [03]	5,9	185/205/220	F4AE3681A*...; F4AE3681D*...; F4AE3681E*...	09.05→	DBJ	6	<b>0 445 120 054</b>	
<b>260 E</b> 28 [03]	5,9	202	F4AE0681A*C...	09.03-08.05	DBJ	6	<b>0 445 120 212</b>	<b>0 986 435 508</b>
<b>320 E</b> 28	5,9	202	F4AE0681A*C...	09.00-08.03	DBJ	6	<b>0 445 120 212</b>	<b>0 986 435 508</b>
<b>Iveco</b>								
<b>2.8</b>	2,8	125	Sofim	12.04→	<del>DBJ</del>	4	<b>0 445 120 002</b>	<b>0 986 435 501</b>
<b>Scudato</b>								
<b>60 .13</b>	2,8	92	8140.43S	10.05→	<del>DBJ</del>	4	<b>0 445 120 002</b>	<b>0 986 435 501</b>

**KAMAZ**

<b>11t</b>								
<b>4308</b> -A3	6,7	155	6IS... <Euro 3>	01.08→	DBJ	6	<b>0 445 120 123</b>	
-H3	4,5	136	4IS... <Euro 3>	01.08→	DBJ	4	<b>0 445 120 123</b>	
<b>18t</b>								
<b>5460</b>	11,8	265	740.72-360 <Euro 4>	10.09→	DBJ	8	<b>0 445 120 153</b>	
<b>5480</b>	11,8	294	740.73-400 <Euro 4>	03.08→	DBJ	8	<b>0 445 120 153</b>	
<b>20t</b>								
<b>53605</b> -D3	6,7	210	6ISBe285 <Euro 3>	01.08→	DBJ	6	<b>0 445 120 123</b>	
<b>25t</b>								
<b>62115</b>	11,8	206/236	740.70-280 <Euro 4>; 740.71-320 <Euro 4>	10.09→	DBJ	8	<b>0 445 120 153</b>	
<b>65115</b> -D3	6,7	210	6ISBe285 <Euro 3>	01.08→	DBJ	6	<b>0 445 120 123</b>	
<b>26t</b>								
<b>6520</b> -19	8,9	251,7-257	ISLe+350 <Euro 3>	01.08→	DBJ	6	<b>0 445 120 070</b>	
<b>33t</b>								
<b>6520</b> -B4	8,8	272,2	ISLe 380 <Euro 3>	10.09→	DBJ	6	<b>0 445 120 070</b>	

**KAVZ KURGAN**

<b>Serie 4000</b>								
<b>4235</b>	3,9	110	ISBe 150 31 <Euro 3>	09.08→	DBJ	4	<b>0 445 120 123</b>	
	4,5	136	4ISBe185B <Euro 3>	09.08→	DBJ	4	<b>0 445 120 123</b>	
<b>4238</b>	4,8	158	TCD 2013 L04 4V <Euro 3>	01.10→	<del>DBJ</del>	4	<b>0 445 120 074</b>	
	6,7	155	6ISBe 210 <Euro 3>	09.08→	DBJ	6	<b>0 445 120 123</b>	
<b>Serie 320000</b>								
<b>324410</b>	4,8	115	D 245.30 E3 <Euro 3>	01.08→	<del>DBJ</del>	4	<b>0 445 120 141</b>	

**LDV GROUP LIMITED**

<b>Maxus</b>								
<b>2.5</b>	2,5	70-88	VM39C; VM40C	01.05→	DBJ	4	<b>0 445 110 059</b>	<b>0 986 435 149</b>

**LIAZ LIKINSKI (RUS)**

<b>Serie 6000</b>								
<b>6212</b>	11,1	303	650 DCi 11 <Euro 3>	06.08→	<del>DBJ</del>	6	<b>0 445 120 142</b>	





MAN

<b>Bus 18t</b>									
18.320 HOCLN	10,5	235	D2066 LOH01 <V6500 Euro 4>	10.06→	DBJ	6	0 445 120 217	0 986 435 526	
18.360 HOCLN	10,5	265	D2066 LOH02 <V6500 Euro 4>	10.06→	DBJ	6	0 445 120 217	0 986 435 526	
18.400 HOCLN	10,5	294	D2066 LOH03 <V6500 Euro 4>	10.06→	DBJ	6	0 445 120 217	0 986 435 526	
18.440 HOCLN	10,5	324	D2066 LOH04 <V6500 Euro 4>	10.06→	DBJ	6	0 445 120 217	0 986 435 526	
<b>Bus 24t</b>									
24.320 HOCLN	10,5	235	D2066 LOH01 <V6500 Euro 4>	10.06→	DBJ	6	0 445 120 217	0 986 435 526	
24.360 HOCLN	10,5	265	D2066 LOH02 <V6500 Euro 4>	10.06→	DBJ	6	0 445 120 217	0 986 435 526	
24.400 HOCLN	10,5	294	D2066 LOH03 <V6500 Euro 4>	10.06→	DBJ	6	0 445 120 217	0 986 435 526	
24.440 HOCLN	10,5	324	D2066 LOH04 <V6500 Euro 4>	10.06→	DBJ	6	0 445 120 217	0 986 435 526	
<b>Lion's City</b>									
G, GL	10,5	228/257	D 2066 LUH02 <Euro4>; D 2066 LUH12 <Euro4>	10.06→	DBJ	6	0 445 120 217	0 986 435 526	
<b>Lion's City / NL</b>									
NL 243 [A37]	6,9	176	D 0836 LOH41 <V5600, Euro 3>	01.02-09.06	DBJ	6	0 445 120 045		
NL 283 [A37]	6,9	206	D 0836 LOH40 <V5600, Euro 3>	01.02-09.06	DBJ	6	0 445 120 045		
<b>Lion's City M / NM</b>									
[A47]	6,9	176/206	D 0836 LOH51 <Euro 4>; D 0836 LOH52 <V7200, Euro4>	01.06-08.09	DBJ	6	0 445 120 098		
<b>Lion's City Ü</b>									
[A21]	10,5	199/228	D 2066 LUH11 <V6400, Euro 4>; D 2066 LUH12 <V6400, Euro 4>	10.06→	DBJ	6	0 445 120 217	0 986 435 526	
<b>Lion's Coach</b>									
	10,5	294/324	D 2066 LOH03 <Euro 4>; D 2066 LOH04 <Euro 4>	09.05→	DBJ	6	0 445 120 217	0 986 435 526	
<b>C, L</b>									
	10,5	294/324	D 2066 LOH07 <Euro 4/OBD1>; D 2066 LOH08 <Euro 4/OBD1>	04.07→	DBJ	6	0 445 120 217	0 986 435 526	
	12,4	338	D 2676 LOH01 <V6700, Euro 4>	09.05-09.06	DBJ	6	0 445 120 219	0 986 435 528	
<b>Lion's Regio C</b>									
[R12, R14]	10,5	228/257/287	D 2066 LUH01 <V6400, Euro4>; D 2066 LUH02 <V6400, Euro4>; D 2066 LUH03 <V6400, Euro4>	10.06-05.07	DBJ	6	0 445 120 217	0 986 435 526	
<b>Lion's Regio L</b>									
[R13]	10,5	228/257/287	D 2066 LUH01 <V6400, Euro4>; D 2066 LUH02 <V6400, Euro4>; D 2066 LUH03 <V6400, Euro4>	10.06-05.07	DBJ	6	0 445 120 217	0 986 435 526	
<b>TAG</b>									
24.430 FN, FP	10,5	316	D 2066 LF01 <V5500, Euro 3>	09.04-09.06	DBJ	6	0 445 120 218	0 986 435 517	
<b>TGA</b>									
18.310 FA, FH, FC, FK, FL	10,5	228	D 2066 LF04 <V5500, Euro 3>	03.04-09.06	DBJ	6	0 445 120 218	0 986 435 517	
FC, FK, FL	10,5	228	D 2066 LF14 <V5500, Euro 4>	04.06-09.07	DBJ	6	0 445 120 217	0 986 435 526	
18.320 F, FL, FA, FC, FK, FL, FC, FK, FL	10,5	235	D 2066 LF20 <V5500, Euro 5>; D 2066 LF28 <Euro 5/OBD1>; D 2066 LF30 <Euro 5/OBD1>; D 2066 LF35 <V5500, Euro 4>; D 2066 LF39 <V5500, Euro 4>	07.06-03.09	DBJ	6	0 445 120 217	0 986 435 526	
18.350 FA, FC, FK, FL	10,5	257	D 2066 LF03 <V5500, Euro 3>	03.04-08.08	DBJ	6	0 445 120 218	0 986 435 517	
FA, FC, FK, FL, FA, FH	10,5	257	D 2066 LF13 <V5500, Euro 4>	10.04-09.06	DBJ	6	0 445 120 217	0 986 435 526	
18.360 F, FL, FA, FC, FK, FL	10,5	265	D 2066 LF19 <V5500, Euro 5>; D 2066 LF27 <Euro 5/OBD1>; D 2066 LF29 <V5500, Euro 5>; D 2066 LF33 <V5500, Euro 4>; D 2066 LF38 <V5500, Euro 4>	07.06-03.09	DBJ	6	0 445 120 217	0 986 435 526	
18.390 FA, FH, FC, FK, FL	10,5	287	D 2066 LF02 <V5500, Euro 3>	03.04-08.08	DBJ	6	0 445 120 218	0 986 435 517	
FA, FL, FC, FK, FL	10,5	287	D 2066 LF12 <Euro 4>	10.04-09.06	DBJ	6	0 445 120 217	0 986 435 526	
18.400 F, FL, FA, FC, FK, FL, FC, FK, FL	10,5	292/294	D 2066 LF18 <Euro 5/OBD1>; D 2066 LF22 <V5500, Euro 5>; D 2066 LF24 <Euro 5/OBD1>; D 2066 LF26 <Euro 5/OBD1>; D 2066 LF32 <V5500, Euro 4>; D 2066 LF37 <V5500, Euro 4>	01.06-03.09	DBJ	6	0 445 120 217	0 986 435 526	
18.430 FA, FH, FC, FK, FL	10,5	316	D 2066 LF01 <V5500, Euro 3>	03.04-08.08	DBJ	6	0 445 120 218	0 986 435 517	
FC, FK, FL	10,5	316	D 2066 LF11 <V5500, Euro 4>	09.04-09.06	DBJ	6	0 445 120 217	0 986 435 526	















◀ MAN

<b>18.440</b> F, FL, FA, FC, FH, FK, FL, FA, FC, FK, FL, FC, FK, FL	10,5	321/324	D 2066 LF17 <Euro 5/OBD1>; D 2066 LF21 <V5500, Euro 5>; D 2066 LF23 <Euro 5/OBD1>; D 2066 LF25 <Euro 5/OBD1>; D 2066 LF31 <V5500, Euro 4>; D 2066 LF36 <V5500, Euro 4>	01.06-03.09	DBJ	6	<b>0 445 120 217</b>	<b>0 986 435 526</b>
<b>18.480</b> F, FA, FC, FK, FL	12,8	353	D 2876 LF12 <V5300, Euro 3>	10.02-09.06	DBJ	6	<b>0 445 120 044</b>	<b>0 986 435 527</b>
F, FL, FA, FC, FH, FK, FL	12,4	353	D 2676 LF01 <V7300, Euro 4>; D 2676 LF05 <V7300, Euro 4>; D 2676 LF12 <V7300, Euro 5 OBD>; D 2676 LF14 <V7300, Euro 5>; D 2676 LF16 <V7300, Euro 5>	04.06-03.09	DBJ	6	<b>0 445 120 219</b>	<b>0 986 435 528</b>
<b>18.530</b> F, FL, FC, FK, FL	12,8	390	D 2876 LF13 <V5300, Euro 3>	10.02-09.06	DBJ	6	<b>0 445 120 044</b>	<b>0 986 435 527</b>
<b>18.540</b> F, FL	12,4	397	D 2676 LF11 <Euro 5/OBD1>; D 2676 LF13 <V7300, Euro 5>; D 2676 LF15 <V7300, Euro 5>	02.07-08.08	DBJ	6	<b>0 445 120 219</b>	<b>0 986 435 528</b>
<b>19.350</b> FL-, FC-, FK-WW	10,5	258	D 2066 LF03 <Euro 3>	07.06-05.10	DBJ	6	<b>0 445 120 218</b>	<b>0 986 435 517</b>
<b>19.360</b> FL-, FC-, FK-WW	10,5	265	D 2066 LF07 <Euro 2>	07.06-05.10	DBJ	6	<b>0 445 120 218</b>	<b>0 986 435 517</b>
<b>19.390</b> FL-, FC-, FK-WW	10,5	287	D 2066 LF02 <Euro 3>	07.06-05.10	DBJ	6	<b>0 445 120 218</b>	<b>0 986 435 517</b>
<b>19.400</b> FL-, FC-, FK-WW	10,5	294	D 2066 LF06 <Euro 2>	07.06-05.10	DBJ	6	<b>0 445 120 218</b>	<b>0 986 435 517</b>
<b>19.430</b> FL-, FC-, FK-WW	10,5	316	D 2066 LF01 <Euro 3>	07.06-05.10	DBJ	6	<b>0 445 120 218</b>	<b>0 986 435 517</b>
<b>19.440</b> FL-, FC-, FK-WW	12,4	324	D 2676 LF04 <Euro 2>	07.06-05.10	DBJ	6	<b>0 445 120 219</b>	<b>0 986 435 528</b>
<b>19.480</b> FL-, FC-, FK-WW	12,4	353	D 2676 LF02 <Euro 3>; D 2676 LF03 <Euro 2>	07.06-05.10	DBJ	6	<b>0 445 120 219</b>	<b>0 986 435 528</b>
<b>24.350</b> FN, FP	10,5	257	D 2066 LF03 <V5500, Euro 3>; D 2066 LF13 <V5500, Euro 4>	09.04-09.06 10.04-09.06	DBJ DBJ	6 6	<b>0 445 120 218</b> <b>0 445 120 217</b>	<b>0 986 435 517</b> <b>0 986 435 526</b>
<b>24.360</b> DF, FN	10,5	265	D 2066 LF19 <V5500, Euro 5>; D 2066 LF27 <Euro 5/OBD1>; D 2066 LF29 <V5500, Euro 5>; D 2066 LF33 <V5500, Euro 4>; D 2066 LF38 <V5500, Euro 4>	07.06-03.09	DBJ	6	<b>0 445 120 217</b>	<b>0 986 435 526</b>
<b>24.390</b> FN, FP	10,5	287	D 2066 LF02 <V5500, Euro 3>; D 2066 LF12 <Euro 4>	09.04-09.06 10.04-09.06	DBJ DBJ	6 6	<b>0 445 120 218</b> <b>0 445 120 217</b>	<b>0 986 435 517</b> <b>0 986 435 526</b>
<b>24.400</b> DF, FN	10,5	292/294	D 2066 LF18 <Euro 5/OBD1>; D 2066 LF22 <V5500, Euro 5>; D 2066 LF24 <Euro 5/OBD1>; D 2066 LF26 <Euro 5/OBD1>; D 2066 LF32 <V5500, Euro 4>; D 2066 LF37 <V5500, Euro 4>	07.06-03.09	DBJ	6	<b>0 445 120 217</b>	<b>0 986 435 526</b>
<b>24.430</b> FN, FP	10,5	316	D 2066 LF11 <V5500, Euro 4>	10.04-09.06	DBJ	6	<b>0 445 120 217</b>	<b>0 986 435 526</b>
<b>24.440</b> DF, FD, FN, FP	10,5	321/324	D 2066 LF17 <Euro 5/OBD1>; D 2066 LF21 <V5500, Euro 5>; D 2066 LF23 <Euro 5/OBD1>; D 2066 LF25 <Euro 5/OBD1>; D 2066 LF31 <V5500, Euro 4>; D 2066 LF36 <V5500, Euro 4>	07.06-03.09	DBJ	6	<b>0 445 120 217</b>	<b>0 986 435 526</b>
<b>24.480</b> DF, FN	12,4	353	D 2676 LF01 <V7300, Euro 4>; D 2676 LF05 <V7300, Euro 4>; D 2676 LF12 <V7300, Euro 5 OBD>; D 2676 LF14 <V7300, Euro 5>; D 2676 LF16 <V7300, Euro 5>	07.06-03.09	DBJ	6	<b>0 445 120 219</b>	<b>0 986 435 528</b>
FN, FP, FV	12,8	353	D 2876 LF12 <V5300, Euro 3>	06.03-09.06	DBJ	6	<b>0 445 120 044</b>	<b>0 986 435 527</b>
<b>24.530</b> FN, FP, FV	12,8	390	D 2876 LF13 <V5300, Euro 3>	12.02-09.06	DBJ	6	<b>0 445 120 044</b>	<b>0 986 435 527</b>
<b>24.540</b> DF	12,4	397	D 2676 LF11 <Euro 5/OBD1>; D 2676 LF13 <V7300, Euro 5>; D 2676 LF15 <V7300, Euro 5>	02.07-08.08	DBJ	6	<b>0 445 120 219</b>	<b>0 986 435 528</b>
<b>26.280</b> DF	6,9	206	D 0836 LF41 <V5200, Euro 3>	03.03-09.04	DBJ	6	<b>0 445 120 098</b>	
				10.04-02.05	DBJ	6	<b>0 445 120 045</b>	
<b>26.310</b> FD, FH, FN, FV, FD, FV	10,5	228	D 2066 LF04 <V5500, Euro 3>; D 2066 LF14 <V5500, Euro 4>	03.04-09.06 04.06-09.07	DBJ DBJ	6 6	<b>0 445 120 218</b> <b>0 445 120 217</b>	<b>0 986 435 517</b> <b>0 986 435 526</b>
<b>26.320</b> FD, FH, FN, FV	10,5	235	D 2066 LF20 <V5500, Euro 5>; D 2066 LF28 <Euro 5/OBD1>; D 2066 LF30 <Euro 5/OBD1>; D 2066 LF35 <V5500, Euro 4>; D 2066 LF39 <V5500, Euro 4>	07.06-09.08	DBJ	6	<b>0 445 120 217</b>	<b>0 986 435 526</b>
<b>26.330</b> DA	6,9	240	D 0836 LF44 <V5200, Euro 3>	03.03-09.04 10.04-02.05	DBJ DBJ	6 6	<b>0 445 120 098</b> <b>0 445 120 045</b>	
<b>26.350</b> FD, FH, FN, FV, FD, FV	10,5	257	D 2066 LF03 <V5500, Euro 3>; D 2066 LF13 <V5500, Euro 4>	03.04-09.06 10.04-09.06	DBJ DBJ	6 6	<b>0 445 120 218</b> <b>0 445 120 217</b>	<b>0 986 435 517</b> <b>0 986 435 526</b>
<b>26.360</b> FD, FH, FN, FV	10,5	265	D 2066 LF19 <V5500, Euro 5>; D 2066 LF27 <Euro 5/OBD1>; D 2066 LF29 <V5500, Euro 5>; D 2066 LF33 <V5500, Euro 4>; D 2066 LF38 <V5500, Euro 4>	07.06-09.08	DBJ	6	<b>0 445 120 217</b>	<b>0 986 435 526</b>
<b>26.390</b> FD, FFD, FD, FH, FN, FV	10,5	287	D 2066 LF12 <Euro 4>	10.04-09.06	DBJ	6	<b>0 445 120 217</b>	<b>0 986 435 526</b>
FD, FFD, FV, FD, FH, FN, FV	10,5	287	D 2066 LF02 <V5500, Euro 3>	03.04-09.06	DBJ	6	<b>0 445 120 218</b>	<b>0 986 435 517</b>





										
<b>26.400</b> FD, FH, FN, FV	10,5	292/294	D 2066 LF18 <Euro 5/OBD1>; D 2066 LF22 <V5500, Euro 5>; D 2066 LF24 <Euro 5/OBD1>; D 2066 LF26 <Euro 5/OBD1>; D 2066 LF32 <V5500, Euro 4>; D 2066 LF37 <V5500, Euro 4>	01.06-09.08	DBJ	6	<b>0 445 120 217</b>	<b>0 986 435 526</b>		
<b>26.430</b> FD, FD, FH, FN, FV	10,5	316	D 2066 LF01 <V5500, Euro 3> D 2066 LF11 <V5500, Euro 4>	03.04-09.06 10.04-09.06	DBJ DBJ	6 6	<b>0 445 120 218</b> <b>0 445 120 217</b>	<b>0 986 435 517</b> <b>0 986 435 526</b>		
<b>26.440</b> F, FL, FD, FH, FN, FV	10,5	321/324	D 2066 LF17 <Euro 5/OBD1>; D 2066 LF21 <V5500, Euro 5>; D 2066 LF23 <Euro 5/OBD1>; D 2066 LF25 <Euro 5/OBD1>; D 2066 LF31 <V5500, Euro 4>; D 2066 LF36 <V5500, Euro 4>	01.06-03.09	DBJ	6	<b>0 445 120 217</b>	<b>0 986 435 526</b>		
<b>26.480</b> DA, FD, FN, FP, FV	12,8	353	D 2876 LF12 <V5300, Euro 3>	09.02-09.06	DBJ	6	<b>0 445 120 044</b>	<b>0 986 435 527</b>		
FD, FH, FN, FV	12,4	353	D 2676 LF01 <V7300, Euro 4>; D 2676 LF05 <V7300, Euro 4>; D 2676 LF12 <V7300, Euro 5>; D 2676 LF14 <V7300, Euro 5>; D 2676 LF16 <V7300, Euro 5>	07.06-03.09	DBJ	6	<b>0 445 120 219</b>	<b>0 986 435 528</b>		
<b>26.530</b> DA, FD, FN, FP, FV	12,8	390	D 2876 LF13 <V5300, Euro 3>	09.02-09.06	DBJ	6	<b>0 445 120 044</b>	<b>0 986 435 527</b>		
<b>26.540</b> FD, FH, FN, FV	12,4	397	D 2676 LF11 <Euro 5/OBD1>; D 2676 LF13 <V7300, Euro 5>; D 2676 LF15 <V7300, Euro 5>	02.07-08.08	DBJ	6	<b>0 445 120 219</b>	<b>0 986 435 528</b>		
<b>28.310</b> DF, FN	10,5	228	D 2066 LF04 <V5500, Euro 3> D 2066 LF14 <V5500, Euro 4>	03.04-09.06 10.04-06.07	DBJ DBJ	6 6	<b>0 445 120 218</b> <b>0 445 120 217</b>	<b>0 986 435 517</b> <b>0 986 435 526</b>		
<b>28.320</b> DF, FN	10,5	235/236	D 2066 LF20 <V5500, Euro 5>; D 2066 LF28 <Euro 5/OBD1>; D 2066 LF30 <Euro 5/OBD1>; D 2066 LF35 <V5500, Euro 4>; D 2066 LF39 <V5500, Euro 4>	04.06-08.08	DBJ	6	<b>0 445 120 217</b>	<b>0 986 435 526</b>		
<b>28.350</b> DF, FN	10,5	257	D 2066 LF03 <V5500, Euro 3> D 2066 LF13 <V5500, Euro 4>	03.04-09.06 10.04-09.06	DBJ DBJ	6 6	<b>0 445 120 218</b> <b>0 445 120 217</b>	<b>0 986 435 517</b> <b>0 986 435 526</b>		
<b>28.360</b> DF, FN	10,5	265	D 2066 LF19 <V5500, Euro 5>; D 2066 LF27 <Euro 5/OBD1>; D 2066 LF29 <V5500, Euro 5>; D 2066 LF33 <V5500, Euro 4>; D 2066 LF38 <V5500, Euro 4>	07.06-08.08	DBJ	6	<b>0 445 120 217</b>	<b>0 986 435 526</b>		
<b>28.390</b> FN	10,5	287	D 2066 LF02 <V5500, Euro 3> D 2066 LF12 <Euro 4>	03.04-09.06 10.04-09.06	DBJ DBJ	6 6	<b>0 445 120 218</b> <b>0 445 120 217</b>	<b>0 986 435 517</b> <b>0 986 435 526</b>		
<b>28.400</b> FN	10,5	292/294	D 2066 LF18 <Euro 5/OBD1>; D 2066 LF22 <V5500, Euro 5>; D 2066 LF24 <Euro 5/OBD1>; D 2066 LF26 <Euro 5/OBD1>; D 2066 LF32 <V5500, Euro 4>; D 2066 LF37 <V5500, Euro 4>	07.06-08.08	DBJ	6	<b>0 445 120 217</b>	<b>0 986 435 526</b>		
<b>28.430</b> FN	10,5	257/316 316	D 2066 LF01 <V5500, Euro 3> D 2066 LF11 <V5500, Euro 4>	03.04-09.06 10.04-09.06	DBJ DBJ	6 6	<b>0 445 120 218</b> <b>0 445 120 217</b>	<b>0 986 435 517</b> <b>0 986 435 526</b>		
<b>28.440</b> DF, FN	10,5	321/324	D 2066 LF17 <Euro 5/OBD1>; D 2066 LF21 <V5500, Euro 5>; D 2066 LF23 <Euro 5/OBD1>; D 2066 LF25 <Euro 5/OBD1>; D 2066 LF31 <V5500, Euro 4>; D 2066 LF36 <V5500, Euro 4>	01.06-08.08	DBJ	6	<b>0 445 120 217</b>	<b>0 986 435 526</b>		
<b>28.480</b> DF	12,8	353	D 2876 LF12 <V5300, Euro 3>	06.03-09.06	DBJ	6	<b>0 445 120 044</b>	<b>0 986 435 527</b>		
FN	12,4	353	D 2676 LF01 <V7300, Euro 4>; D 2676 LF05 <V7300, Euro 4>; D 2676 LF12 <V7300, Euro 5 OBD>; D 2676 LF14 <V7300, Euro 5>; D 2676 LF16 <V7300, Euro 5>	07.06-08.08	DBJ	6	<b>0 445 120 219</b>	<b>0 986 435 528</b>		
<b>28.530</b> DF	12,8	390	D 2876 LF13 <V5300, Euro 3>	09.02-09.06	DBJ	6	<b>0 445 120 044</b>	<b>0 986 435 527</b>		
<b>28.540</b> FN	12,4	397	D 2676 LF11 <Euro 5/OBD1>; D 2676 LF13 <V7300, Euro 5>; D 2676 LF15 <V7300, Euro 5>	02.07-08.08	DBJ	6	<b>0 445 120 219</b>	<b>0 986 435 528</b>		
<b>32.350</b> FFD	10,5	257	D 2066 LF03 <V5500, Euro 3> D 2066 LF13 <V5500, Euro 4>	06.04-09.06 04.06-09.06	DBJ DBJ	6 6	<b>0 445 120 218</b> <b>0 445 120 217</b>	<b>0 986 435 517</b> <b>0 986 435 526</b>		
<b>32.360</b> FFD	10,5	265	D 2066 LF33 <V5500, Euro 4>; D 2066 LF38 <V5500, Euro 4>	07.06-08.08	DBJ	6	<b>0 445 120 217</b>	<b>0 986 435 526</b>		
<b>32.390</b> FFD	10,5	287	D 2066 LF02 <V5500, Euro 3>	06.04-09.06	DBJ	6	<b>0 445 120 218</b>	<b>0 986 435 517</b>		
<b>32.400</b> FFD	10,5	292/294	D 2066 LF32 <V5500, Euro 4>; D 2066 LF37 <V5500, Euro 4>	07.06-08.08	DBJ	6	<b>0 445 120 217</b>	<b>0 986 435 526</b>		
<b>32.430</b> FFD	10,5	316	D 2066 LF01 <V5500, Euro 3> D 2066 LF11 <V5500, Euro 4>	06.04-09.06 04.06-09.06	DBJ DBJ	6 6	<b>0 445 120 218</b> <b>0 445 120 217</b>	<b>0 986 435 517</b> <b>0 986 435 526</b>		
<b>32.440</b> FFD	10,5	324	D 2066 LF31 <V5500, Euro 4>; D 2066 LF36 <V5500, Euro 4>	07.06-08.08	DBJ	6	<b>0 445 120 217</b>	<b>0 986 435 526</b>		















◀ MAN

<b>32.480</b> FFD	12,4	353	D 2676 LF01 <V7300, Euro 4>; D 2676 LF05 <V7300, Euro 4>	07.06-08.08	DBJ	6	<b>0 445 120 219</b>	<b>0 986 435 528</b>
	12,8	352	D 2876 LF12 <V5300, Euro 3>	05.04-01.06	DBJ	6	<b>0 445 120 044</b>	<b>0 986 435 527</b>
<b>32.530</b> DA	12,8	390	D 2876 LF13 <V5300, Euro 3>	05.04-09.04	DBJ	6	<b>0 445 120 044</b>	<b>0 986 435 527</b>
<b>33.310</b> FFD	10,5	228	D 2066 LF04 <V5500, Euro 3>	03.04-09.06	DBJ	6	<b>0 445 120 218</b>	<b>0 986 435 517</b>
<b>33.350</b> DF, FD, FDA	10,5	257	D 2066 LF13 <V5500, Euro 4>	10.04-09.06	DBJ	6	<b>0 445 120 217</b>	<b>0 986 435 526</b>
FDA, FD-WW	10,5	257	D 2066 LF03 <Euro 3>; D 2066 LF03 <V5500, Euro 3>	03.04-05.10	DBJ	6	<b>0 445 120 218</b>	<b>0 986 435 517</b>
<b>33.360</b> FD	10,5	265	D 2066 LF33 <V5500, Euro 4>	07.06-09.08	DBJ	6	<b>0 445 120 217</b>	<b>0 986 435 526</b>
			D 2066 LF38 <V5500, Euro 4>	10.07-09.08	DBJ	6	<b>0 445 120 217</b>	<b>0 986 435 526</b>
FD-, FDA-WW	10,5	265	D 2066 LF07 <Euro 2>	07.06-05.10	DBJ	6	<b>0 445 120 218</b>	<b>0 986 435 517</b>
<b>33.390</b> DF, FDA	10,5	287	D 2066 LF12 <Euro 4>	10.04-09.06	DBJ	6	<b>0 445 120 217</b>	<b>0 986 435 526</b>
FDA, FD-WW	10,5	287	D 2066 LF02 <Euro 3>; D 2066 LF02 <V5500, Euro 3>	03.04-05.10	DBJ	6	<b>0 445 120 218</b>	<b>0 986 435 517</b>
<b>33.400</b> FD	10,5	292	D 2066 LF32 <V5500, Euro 4>	07.06-08.08	DBJ	6	<b>0 445 120 217</b>	<b>0 986 435 526</b>
		294	D 2066 LF37 <V5500, Euro 4>	10.07-08.08	DBJ	6	<b>0 445 120 217</b>	<b>0 986 435 526</b>
FD-, FDA-WW	10,5	294	D 2066 LF06 <Euro 2>	07.06-05.10	DBJ	6	<b>0 445 120 218</b>	<b>0 986 435 517</b>
<b>33.430</b> DF, FDA	10,5	316	D 2066 LF11 <V5500, Euro 4>	10.04-09.06	DBJ	6	<b>0 445 120 217</b>	<b>0 986 435 526</b>
FDA, FD-WW	10,5	316	D 2066 LF01 <Euro 3>; D 2066 LF01 <V5500, Euro 3>	03.04-05.10	DBJ	6	<b>0 445 120 218</b>	<b>0 986 435 517</b>
<b>33.440</b> FD	10,5	324	D 2066 LF31 <V5500, Euro 4>; D 2066 LF36 <V5500, Euro 4>	07.06-08.08	DBJ	6	<b>0 445 120 217</b>	<b>0 986 435 526</b>
FD-, FDA-WW	12,4	324	D 2676 LF04 <Euro 2>	07.06-05.10	DBJ	6	<b>0 445 120 219</b>	<b>0 986 435 528</b>
<b>33.480</b> DA, FDA-WW, FD-WW	12,8	352/353	D 2876 LF12 <Euro 3>; D 2876 LF12 <V5300, Euro 3>	10.02-03.09	DBJ	6	<b>0 445 120 044</b>	<b>0 986 435 527</b>
FD	12,4	353	D 2676 LF01 <V7300, Euro 4>	07.06-08.08	DBJ	6	<b>0 445 120 219</b>	<b>0 986 435 528</b>
FD, FD-, FDA-WW, FD-WW	12,4	353	D 2676 LF02 <Euro 3>; D 2676 LF03 <Euro 2>; D 2676 LF05 <V7300, Euro 4>	07.06-05.10	DBJ	6	<b>0 445 120 219</b>	<b>0 986 435 528</b>
FD-WW	12,4	353	D 2876 LF25 <Euro 2>	07.06-03.09	DBJ	6	<b>0 445 120 044</b>	<b>0 986 435 527</b>
<b>33.530</b> DF	12,8	390	D 2876 LF13 <V5300, Euro 3>	10.02-09.06	DBJ	6	<b>0 445 120 044</b>	<b>0 986 435 527</b>
<b>35.350</b> FFD, FV	10,5	257	D 2066 LF13 <V5500, Euro 4>	10.04-09.06	DBJ	6	<b>0 445 120 217</b>	<b>0 986 435 526</b>
FFD, VF	10,5	257	D 2066 LF03 <V5500, Euro 3>	03.04-09.06	DBJ	6	<b>0 445 120 218</b>	<b>0 986 435 517</b>
<b>35.360</b> FFD	10,5	265	D 2066 LF33 <V5500, Euro 4>; D 2066 LF38 <V5500, Euro 4>	07.06-08.08	DBJ	6	<b>0 445 120 217</b>	<b>0 986 435 526</b>
<b>35.390</b> FFD	10,5	287	D 2066 LF02 <V5500, Euro 3>	03.04-09.06	DBJ	6	<b>0 445 120 218</b>	<b>0 986 435 517</b>
FFD, FV	10,5	287	D 2066 LF12 <Euro 4>	10.04-09.06	DBJ	6	<b>0 445 120 217</b>	<b>0 986 435 526</b>
<b>35.400</b> FFD	10,5	292/294	D 2066 LF32 <V5500, Euro 4>; D 2066 LF37 <V5500, Euro 4>	07.06-08.08	DBJ	6	<b>0 445 120 217</b>	<b>0 986 435 526</b>
<b>35.430</b> FFD	10,5	316	D 2066 LF01 <V5500, Euro 3>	03.04-09.06	DBJ	6	<b>0 445 120 218</b>	<b>0 986 435 517</b>
FFD, FV	10,5	316	D 2066 LF11 <V5500, Euro 4>	10.04-09.06	DBJ	6	<b>0 445 120 217</b>	<b>0 986 435 526</b>
<b>35.440</b> FFD	10,5	324	D 2066 LF31 <V5500, Euro 4>; D 2066 LF36 <V5500, Euro 4>	07.06-08.08	DBJ	6	<b>0 445 120 217</b>	<b>0 986 435 526</b>
<b>35.480</b> FFD	12,4	353	D 2676 LF01 <V7300, Euro 4>; D 2676 LF05 <V7300, Euro 4>	07.06-08.08	DBJ	6	<b>0 445 120 219</b>	<b>0 986 435 528</b>
	12,8	352/353	D 2876 LF12 <V5300, Euro 3>	06.03-09.06	DBJ	6	<b>0 445 120 044</b>	<b>0 986 435 527</b>
<b>35.530</b> FFD	12,8	390	D 2876 LF13 <V5300, Euro 3>	06.04-03.06	DBJ	6	<b>0 445 120 044</b>	<b>0 986 435 527</b>
<b>37.350</b> FFD	10,5	257	D 2066 LF03 <V5500, Euro 3>	03.04-09.06	DBJ	6	<b>0 445 120 218</b>	<b>0 986 435 517</b>
			D 2066 LF13 <V5500, Euro 4>	10.04-09.06	DBJ	6	<b>0 445 120 217</b>	<b>0 986 435 526</b>
<b>37.360</b> FFD	10,5	265	D 2066 LF33 <V5500, Euro 4>; D 2066 LF38 <V5500, Euro 4>	07.06-08.08	DBJ	6	<b>0 445 120 217</b>	<b>0 986 435 526</b>
<b>37.390</b> FFD	10,5	287	D 2066 LF02 <V5500, Euro 3>	03.04-09.06	DBJ	6	<b>0 445 120 218</b>	<b>0 986 435 517</b>
			D 2066 LF12 <Euro 4>	10.04-09.06	DBJ	6	<b>0 445 120 217</b>	<b>0 986 435 526</b>
<b>37.400</b> FFD	10,5	292/294	D 2066 LF32 <V5500, Euro 4>; D 2066 LF37 <V5500, Euro 4>	07.06-08.08	DBJ	6	<b>0 445 120 217</b>	<b>0 986 435 526</b>
<b>37.430</b> FFD	10,5	316	D 2066 LF01 <V5500, Euro 3>	03.04-09.06	DBJ	6	<b>0 445 120 218</b>	<b>0 986 435 517</b>
			D 2066 LF11 <V5500, Euro 4>	10.04-09.06	DBJ	6	<b>0 445 120 217</b>	<b>0 986 435 526</b>
<b>37.440</b> FFD	10,5	324	D 2066 LF31 <V5500, Euro 4>; D 2066 LF36 <V5500, Euro 4>	07.06-08.08	DBJ	6	<b>0 445 120 217</b>	<b>0 986 435 526</b>
<b>37.480</b> FFD	12,4	353	D 2676 LF01 <V7300, Euro 4>; D 2676 LF05 <V7300, Euro 4>	07.06-08.08	DBJ	6	<b>0 445 120 219</b>	<b>0 986 435 528</b>
VF	12,8	353	D 2876 LF12 <V5300, Euro 3>	08.04-09.06	DBJ	6	<b>0 445 120 044</b>	<b>0 986 435 527</b>



										
<b>37.530</b> VF	12,8	390	D 2876 LF13 <V5300, Euro 3>	06.03-09.06	DBJ	6	<b>0 445 120 044</b>	<b>0 986 435 527</b>		
<b>39.390</b> FV	10,5	287	D 2066 LF02 <V5500, Euro 3>	03.04-09.06	DBJ	6	<b>0 445 120 218</b>	<b>0 986 435 517</b>		
			D 2066 LF12 <Euro 4>	09.05-09.06	DBJ	6	<b>0 445 120 217</b>	<b>0 986 435 526</b>		
<b>39.400</b> FFD	10,5	292/294	D 2066 LF32 <V5500, Euro 4>; D 2066 LF37 <V5500, Euro 4>	07.06-08.08	DBJ	6	<b>0 445 120 217</b>	<b>0 986 435 526</b>		
<b>39.430</b> FFD	10,5	316	D 2066 LF01 <V5500, Euro 3>	07.04-09.06	DBJ	6	<b>0 445 120 218</b>	<b>0 986 435 517</b>		
			D 2066 LF11 <V5500, Euro 4>	09.05-09.06	DBJ	6	<b>0 445 120 217</b>	<b>0 986 435 526</b>		
<b>39.440</b> FFD	10,5	324	D 2066 LF31 <V5500, Euro 4>; D 2066 LF36 <V5500, Euro 4>	07.06-08.08	DBJ	6	<b>0 445 120 217</b>	<b>0 986 435 526</b>		
<b>39.480</b> FFD	12,4	353	D 2676 LF01 <V7300, Euro 4>; D 2676 LF05 <V7300, Euro 4>	07.06-08.08	DBJ	6	<b>0 445 120 219</b>	<b>0 986 435 528</b>		
<b>40.390</b> FDA-WW, FD-WW	10,5	287	D 2066 LF02 <Euro 3>	01.05-05.10	DBJ	6	<b>0 445 120 218</b>	<b>0 986 435 517</b>		
<b>40.400</b> FD-WW	10,5	294	D 2066 LF06 <Euro 2>	07.06-05.10	DBJ	6	<b>0 445 120 218</b>	<b>0 986 435 517</b>		
			D 2066 LF32 <Euro 4/OBD1>; D 2066 LF37 <Euro 4/OBD1>	09.08-05.10	DBJ	6	<b>0 445 120 217</b>	<b>0 986 435 526</b>		
<b>40.430</b> FDA-WW, FD-WW	10,5	316	D 2066 LF01 <Euro 3>	07.04-05.10	DBJ	6	<b>0 445 120 218</b>	<b>0 986 435 517</b>		
<b>40.440</b> FD-WW	10,5	324	D 2066 LF31 <Euro 4/OBD1>; D 2066 LF36 <Euro 4/OBD1>	09.08-05.10	DBJ	6	<b>0 445 120 217</b>	<b>0 986 435 526</b>		
	12,4	324	D 2676 LF04 <Euro 2>	07.06-05.10	DBJ	6	<b>0 445 120 219</b>	<b>0 986 435 528</b>		
<b>40.480</b> DF, FD-WW	12,8	353	D 2876 LF12 <Euro 3>; D 2876 LF12 <V5300, Euro 3>; D 2876 LF25 <Euro 2>	10.04-03.09	DBJ	6	<b>0 445 120 044</b>	<b>0 986 435 527</b>		
FDA-WW	12,4	353	D 2676 LF02 <Euro 3>; D 2676 LF03 <Euro 2>	07.06-05.10	DBJ	6	<b>0 445 120 219</b>	<b>0 986 435 528</b>		
<b>41.350</b> FFD	10,5	257	D 2066 LF13 <V5500, Euro 4>	10.04-09.06	DBJ	6	<b>0 445 120 217</b>	<b>0 986 435 526</b>		
FFD-WW	10,5	257	D 2066 LF03 <Euro 3>	03.04-05.10	DBJ	6	<b>0 445 120 218</b>	<b>0 986 435 517</b>		
<b>41.360</b> FFD	10,5	265	D 2066 LF33 <V5500, Euro 4>	07.06-08.08	DBJ	6	<b>0 445 120 217</b>	<b>0 986 435 526</b>		
			D 2066 LF38 <V5500, Euro 4>	09.07-08.08	DBJ	6	<b>0 445 120 217</b>	<b>0 986 435 526</b>		
FV-WW	10,5	265	D 2066 LF07 <Euro 2>	07.06-05.10	DBJ	6	<b>0 445 120 218</b>	<b>0 986 435 517</b>		
<b>41.390</b> FFD	10,5	287	D 2066 LF12 <Euro 4>	10.04-09.06	DBJ	6	<b>0 445 120 217</b>	<b>0 986 435 526</b>		
FFD-WW	10,5	287	D 2066 LF02 <Euro 3>	03.04-05.10	DBJ	6	<b>0 445 120 218</b>	<b>0 986 435 517</b>		
<b>41.400</b> FFD	10,5	292	D 2066 LF32 <V5500, Euro 4>	07.06-08.08	DBJ	6	<b>0 445 120 217</b>	<b>0 986 435 526</b>		
		294	D 2066 LF37 <V5500, Euro 4>	09.07-08.08	DBJ	6	<b>0 445 120 217</b>	<b>0 986 435 526</b>		
FV-WW	10,5	294	D 2066 LF06 <Euro 2>	07.06-05.10	DBJ	6	<b>0 445 120 218</b>	<b>0 986 435 517</b>		
<b>41.430</b> FFD	10,5	316	D 2066 LF11 <V5500, Euro 4>	10.04-09.06	DBJ	6	<b>0 445 120 217</b>	<b>0 986 435 526</b>		
FFD, FFD-WW	10,5	316	D 2066 LF01 <Euro 3>; D 2066 LF01 <V5500, Euro 3>	03.04-05.10	DBJ	6	<b>0 445 120 218</b>	<b>0 986 435 517</b>		
<b>41.440</b> FFD	10,5	324	D 2066 LF31 <V5500, Euro 4>; D 2066 LF36 <V5500, Euro 4>	07.06-08.08	DBJ	6	<b>0 445 120 217</b>	<b>0 986 435 526</b>		
FV-WW	12,4	324	D 2676 LF04 <Euro 2>	07.06-05.10	DBJ	6	<b>0 445 120 219</b>	<b>0 986 435 528</b>		
<b>41.480</b> FFD	12,4	353	D 2676 LF01 <V7300, Euro 4>	07.06-08.08	DBJ	6	<b>0 445 120 219</b>	<b>0 986 435 528</b>		
FFD, FFD-WW	12,8	353	D 2876 LF12 <Euro 3>; D 2876 LF12 <V5300, Euro 3>	05.03-03.09	DBJ	6	<b>0 445 120 044</b>	<b>0 986 435 527</b>		
FFD, FV-WW	12,4	353	D 2676 LF02 <Euro 3>; D 2676 LF03 <Euro 2>; D 2676 LF05 <V7300, Euro 4>	07.06-05.10	DBJ	6	<b>0 445 120 219</b>	<b>0 986 435 528</b>		
FFD-WW	12,4	353	D 2876 LF25 <Euro 2>	07.06-03.09	DBJ	6	<b>0 445 120 044</b>	<b>0 986 435 527</b>		
<b>41.530</b> FFD, FV	12,8	390	D 2876 LF13 <V5300, Euro 3>	06.03-09.06	DBJ	6	<b>0 445 120 044</b>	<b>0 986 435 527</b>		
<b>41.540</b> FV	12,4	397	D 2676 LF11 <Euro 5/OBD1>; D 2676 LF13 <V7300, Euro 5>	04.07-07.08	DBJ	6	<b>0 445 120 219</b>	<b>0 986 435 528</b>		
<b>41.660</b> VF	18,3	485	D 2840 LF25 <V5800, Euro 3>	04.03-09.06	DBJ	10	<b>0 445 120 031</b>			
<b>TGL</b>										
<b>7.150</b>	4,6	110	D 0834 LFL40 <Euro 3>	06.11→	DBJ	4	<b>0 445 120 045</b>			
			D 0834 LFL60 <Euro 5/EEV/OBD2>; D 0834 LFL63 <Euro 5/OBD2>	04.09→	DBJ	4	<b>0 445 120 186</b>			
L	4,6	110	D 0834 LFL40 <Euro 3>	05.05-09.06	DBJ	4	<b>0 445 120 045</b>			
			D 0834 LFL50 <Euro 4/OBD1>; D 0834 LFL53 <Euro 4/OBD1>	04.06→	DBJ	4	<b>0 445 120 148</b>			
<b>7.180</b>	4,6	132	D 0834 LFL41 <Euro 3>	06.11→	DBJ	4	<b>0 445 120 045</b>			
			D 0834 LFL61 <Euro 5/EEV/OBD2>; D 0834 LFL64 <Euro 5/OBD2>	04.09→	DBJ	4	<b>0 445 120 162</b>			
L	4,6	132	D 0834 LFL41 <Euro 3>	05.05-09.06	DBJ	4	<b>0 445 120 045</b>			
			D 0834 LFL51 <Euro 4/OBD1>; D 0834 LFL54 <Euro 4/OBD1>	04.06→	DBJ	4	<b>0 445 120 147</b>			





◀ MAN

<b>8.150</b>		4,6	110	D 0834 LFL40 <Euro 3>	06.11→	DBJ	4	<b>0 445 120 045</b>
				D 0834 LFL60 <Euro 5/EEV/OBD2>; D 0834 LFL63 <Euro 5/OBD2>	04.09→	DBJ	4	<b>0 445 120 186</b>
L		4,6	110	D 0834 LFL50 <Euro 4/OBD1>; D 0834 LFL53 <Euro 4/OBD1>	02.07→	DBJ	4	<b>0 445 120 148</b>
<b>8.180</b>		4,6	132	D 0834 LFL61 <Euro 5/EEV/OBD2>; D 0834 LFL64 <Euro 5/OBD2>	04.09→	DBJ	4	<b>0 445 120 162</b>
				L	4,6	132	D 0834 LFL41 <Euro 3>; D 0834 LFL51 <Euro 4/OBD1>; D 0834 LFL54 <Euro 4/OBD1>	05.05→ 04.06→
<b>8.210 L</b>		4,6	151	D 0834 LFL42 <Euro 3>; D 0834 LFL52 <Euro 4/OBD1>; D 0834 LFL55 <Euro 4/OBD1>	05.05→ 04.06→	DBJ DBJ	4 4	<b>0 445 120 045</b> <b>0 445 120 147</b>
				<b>8.220</b>	4,6	162	D 0834 LFL62 <Euro 5/EEV/OBD2>; D 0834 LFL65 <Euro 5/OBD2>	04.09→
<b>8.240 L</b>		6,9	176 177	D 0836 LFL40 <Euro 3>; D 0836 LFL50 <Euro 4/OBD1>; D 0836 LFL53 <Euro 4/OBD1>	05.05→ 01.08→	DBJ DBJ	6 6	<b>0 445 120 045</b> <b>0 445 120 148</b>
				<b>8.250</b>	6,9	184	D 0836 LFL60 <Euro 5/EEV/OBD2>; D 0836 LFL63 <Euro 5/OBD2>	04.09→
<b>10.180</b>	L	4,6	132	D 0834 LFL61 <Euro 5/EEV/OBD2>; D 0834 LFL64 <Euro 5/OBD2>	04.09→	DBJ	4	<b>0 445 120 162</b>
				D 0834 LFL41 <Euro 3>; D 0834 LFL51 <Euro 4>; D 0834 LFL54 <Euro 4/OBD1>	05.05→ 04.06-09.07 09.07→	DBJ DBJ DBJ	4 4 4	<b>0 445 120 045</b> <b>0 445 120 098</b> <b>0 445 120 147</b>
				<b>10.210 L</b>	4,6	151	D 0834 LFL42 <Euro 3>; D 0834 LFL52 <Euro 4>; D 0834 LFL55 <Euro 4/OBD1>	05.05→ 04.06-09.07 09.07→
<b>10.220</b>		4,6	162	D 0834 LFL62 <Euro 5/EEV/OBD2>; D 0834 LFL65 <Euro 5/OBD2>	04.09→	DBJ	4	<b>0 445 120 162</b>
<b>10.240 L</b>		6,9	176 177	D 0836 LFL40 <V6000, Euro 3>; D 0836 LFL50 <Euro 4/OBD1>; D 0836 LFL53 <Euro 4/OBD1>	05.05→ 01.08→	DBJ DBJ	6 6	<b>0 445 120 045</b> <b>0 445 120 148</b>
				<b>10.250</b>	6,9	184	D 0836 LFL60 <Euro 5/EEV/OBD2>; D 0836 LFL63 <Euro 5/OBD2>	04.09→
<b>12.180</b>	L	4,6	132	D 0834 LFL61 <Euro 5/EEV/OBD2>; D 0834 LFL64 <Euro 5/OBD2>	04.09→	DBJ	4	<b>0 445 120 162</b>
				D 0834 LFL41 <Euro 3>; D 0834 LFL51 <Euro 4>; D 0834 LFL54 <Euro 4/OBD1>	05.05→ 04.06-09.07 09.07→	DBJ DBJ DBJ	4 4 4	<b>0 445 120 045</b> <b>0 445 120 098</b> <b>0 445 120 147</b>
				<b>12.210 L</b>	4,6	151	D 0834 LFL42 <Euro 3>; D 0834 LFL52 <Euro 4>; D 0834 LFL55 <Euro 4/OBD1>	05.05→ 04.06-09.07 09.07→
<b>12.220</b>		4,6	162	D 0834 LFL62 <Euro 5/EEV/OBD2>; D 0834 LFL65 <Euro 5/OBD2>	04.09→	DBJ	4	<b>0 445 120 162</b>
<b>12.240 L</b>		6,9	176 177	D 0836 LFL40 <V6000, Euro 3>; D 0836 LFL50 <Euro 4/OBD1>; D 0836 LFL53 <Euro 4/OBD1>	05.05→ 01.08→	DBJ DBJ	6 6	<b>0 445 120 045</b> <b>0 445 120 148</b>
				<b>12.250</b>	6,9	184	D 0836 LFL60 <Euro 5/EEV/OBD2>; D 0836 LFL63 <Euro 5/OBD2>	04.09→
<b>TGM</b>								
<b>12.240 L</b>		6,9	177	D 0836 LFL50 <Euro 4/OBD1>; D 0836 LFL53 <Euro 4/OBD1>	01.08→	DBJ	6	<b>0 445 120 148</b>
<b>12.250</b>		6,9	184	D 0836 LFL60 <Euro 5/EEV/OBD2>; D 0836 LFL63 <Euro 5/OBD2>	04.09→	DBJ	6	<b>0 445 120 186</b>
<b>12.280 L</b>		6,9	206	D 0836 LFL51 <V7100, Euro 4>; D 0836 LFL54 <Euro 4/OBD1>	04.06-09.07 01.08→	DBJ DBJ	6 6	<b>0 445 120 098</b> <b>0 445 120 147</b>
				<b>12.290</b>	6,9	213	D 0836 LFL61 <Euro 5/EEV/OBD2>; D 0836 LFL64 <Euro 5/OBD2>	04.09→
<b>13.240 L</b>		6,9	176 176/177	D 0836 LFL40 <Euro 3>; D 0836 LFL50 <Euro 4/OBD1>; D 0836 LFL53 <Euro 4/OBD1>	10.06→ 01.08→	DBJ DBJ	6 6	<b>0 445 120 045</b> <b>0 445 120 148</b>





<b>13.250</b>	6,9	184	D 0836 LFL60 <Euro 5/EEV/OBD2>; D 0836 LFL63 <Euro 5/OBD2>	04.09→	DBJ	6	<b>0 445 120 186</b>
<b>13.280 L</b>	6,9	206	D 0836 LFL41 <Euro 3> D 0836 LFL51 <V7100, Euro 4> D 0836 LFL54 <Euro 4/OBD1>	07.06→ 10.06-09.07 01.08→	DBJ DBJ DBJ	4 6 6	<b>0 445 120 147</b> <b>0 445 120 098</b> <b>0 445 120 147</b>
<b>13.290</b>	6,9	213	D 0836 LFL61 <Euro 5/EEV/OBD2>; D 0836 LFL64 <Euro 5/OBD2>	04.09→	DBJ	6	<b>0 445 120 162</b>
<b>15.240</b>	6,9	176	D 0836 LFL40 <Euro 3>	09.11→	DBJ	6	<b>0 445 120 045</b>
L	6,9	177	D 0836 LFL50 <Euro 4/OBD1>; D 0836 LFL53 <Euro 4/OBD1>	01.08→	DBJ	6	<b>0 445 120 148</b>
<b>15.250</b>	6,9	184	D 0836 LFL60 <Euro 5/EEV/OBD2>; D 0836 LFL63 <Euro 5/OBD2>	04.09→	DBJ	6	<b>0 445 120 186</b>
<b>15.280</b>	6,9	206	D 0836 LFL41 <Euro 3>	09.11→	DBJ	6	<b>0 445 120 045</b>
L	6,9	206	D 0836 LFL51 <V7100, Euro 4> D 0836 LFL54 <Euro 4/OBD1>	04.06-09.07 01.08→	DBJ DBJ	6 6	<b>0 445 120 098</b> <b>0 445 120 147</b>
<b>15.290</b>	6,9	213	D 0836 LFL61 <Euro 5/EEV/OBD2>; D 0836 LFL64 <Euro 5/OBD2>	04.09→	DBJ	6	<b>0 445 120 162</b>
<b>15.330</b>	6,9	240	D 0836 LFL44 <Euro 3>	09.11→	DBJ	6	<b>0 445 120 045</b>
L	6,9	240	D 0836 LFL51 <Euro 4/OBD1> D 0836 LFL55 <Euro 4/OBD1>	04.06-09.07 01.08→	DBJ DBJ	6 6	<b>0 445 120 098</b> <b>0 445 120 147</b>
<b>15.340</b>	6,9	250	D 0836 LFL62 <Euro 5/EEV/OBD2>; D 0836 LFL65 <Euro 5/OBD2>	04.09→	DBJ	6	<b>0 445 120 162</b>
<b>18.240 L</b>	6,9	176 177	D 0836 LFL40 <Euro 3> D 0836 LFL50 <Euro 4/OBD1>; D 0836 LFL53 <Euro 4/OBD1>	10.05→ 01.08→	DBJ DBJ	6 6	<b>0 445 120 045</b> <b>0 445 120 148</b>
<b>18.250</b>	6,9	184	D 0836 LFL60 <Euro 5/EEV/OBD2>; D 0836 LFL63 <Euro 5/OBD2>	04.09→	DBJ	6	<b>0 445 120 186</b>
<b>18.280 , L</b>	6,9	206	D 0836 LFL51 <Euro 4/OBD1>; D 0836 LFL54 <Euro 4/OBD1>	01.08→	DBJ	6	<b>0 445 120 147</b>
L	6,9	206	D 0836 LFL41 <Euro 3>	10.05→	DBJ	6	<b>0 445 120 045</b>
<b>18.290</b>	6,9	213	D 0836 LFL61 <Euro 5/EEV/OBD2>; D 0836 LFL64 <Euro 5/OBD2>	04.09→	DBJ	6	<b>0 445 120 162</b>
<b>18.330 , L</b>	6,9	240	D 0836 LFL52 <Euro 4/OBD1>; D 0836 LFL55 <Euro 4/OBD1>	01.08→	DBJ	6	<b>0 445 120 147</b>
L	6,9	240	D 0836 LFL44 <Euro 3>	10.05→	DBJ	6	<b>0 445 120 045</b>
<b>18.340</b>	6,9	250	D 0836 LFL62 <Euro 5/EEV/OBD2>; D 0836 LFL65 <Euro 5/OBD2>	04.09→	DBJ	6	<b>0 445 120 162</b>
<b>22.240 L</b>	6,9	176	D 0836 LFL53 <Euro 4/OBD1>	01.08→	DBJ	6	<b>0 445 120 148</b>
<b>22.250</b>	6,9	184	D 0836 LFL60 <Euro 5/EEV/OBD2>; D 0836 LFL63 <Euro 5/OBD2>	04.09→	DBJ	6	<b>0 445 120 186</b>
<b>22.280</b>	6,9	206	D 0836 LFL54 <Euro 4/OBD1>	01.08→	DBJ	6	<b>0 445 120 147</b>
<b>22.290</b>	6,9	213	D 0836 LFL61 <Euro 5/EEV/OBD2>; D 0836 LFL64 <Euro 5/OBD2>	04.09→	DBJ	6	<b>0 445 120 162</b>
<b>26.280 L</b>	6,9	206	D 0836 LFL51 <Euro 4/OBD1>; D 0836 LFL54 <Euro 4/OBD1>	01.08→	DBJ	6	<b>0 445 120 147</b>
<b>26.290</b>	6,9	213	D 0836 LFL61 <Euro 5/EEV/OBD2>; D 0836 LFL64 <Euro 5/OBD2>	04.09→	DBJ	6	<b>0 445 120 162</b>
<b>26.330 L</b>	6,9	240	D 0836 LFL52 <Euro 4/OBD1>; D 0836 LFL55 <Euro 4/OBD1>	01.08→	DBJ	6	<b>0 445 120 147</b>
<b>26.340</b>	6,9	250	D 0836 LFL62 <Euro 5/EEV/OBD2>; D 0836 LFL65 <Euro 5/OBD2>	04.09→	DBJ	6	<b>0 445 120 162</b>
<b>TGS</b>							
<b>18.320</b>	10,5	235	D 2066 LF20 <Euro 5/OBD1>; D 2066 LF28 <Euro 5/OBD1>; D 2066 LF39 <Euro 4/OBD1>; D 2066 LF43 <Euro 5/OBD2>; D 2066 LF60 <Euro 5/EEV/OBD2>	10.07→	DBJ	6	<b>0 445 120 217 0 986 435 526</b>
<b>18.360</b>	10,5	265	D 2066 LF19 <Euro 5/OBD1>; D 2066 LF27 <Euro 5/OBD1>; D 2066 LF38 <Euro 4/OBD1>; D 2066 LF42 <Euro 5/OBD2>; D 2066 LF59 <Euro 5/EEV/OBD2>	10.07→	DBJ	6	<b>0 445 120 217 0 986 435 526</b>





◀ MAN

<b>18.400</b>	10,5	294	D 2066 LF18 <Euro 5/OBD1>; D 2066 LF26 <Euro 5/OBD1>; D 2066 LF37 <Euro 4/OBD1>; D 2066 LF41 <Euro 5/OBD2>; D 2066 LF58 <Euro 5/EEV/OBD2>	10.07→	DBJ	6	<b>0 445 120 217</b>	<b>0 986 435 526</b>
<b>18.440</b>	10,5	324	D 2066 LF17 <Euro 5/OBD1>; D 2066 LF25 <Euro 5/OBD1>; D 2066 LF36 <Euro 4/OBD1>; D 2066 LF40 <Euro 5/OBD2>; D 2066 LF57 <Euro 5/EEV/OBD2>	10.07→	DBJ	6	<b>0 445 120 217</b>	<b>0 986 435 526</b>
<b>18.480</b> , F, FL	12,4	353	D 2676 LF05 <Euro 4/OBD1>; D 2676 LF07 <Euro 5/OBD2>; D 2676 LF14 <Euro 5/OBD1>; D 2676 LF16 <Euro 5/OBD1>; D 2676 LF18 <Euro 5/EEV/OBD2>	10.07→	DBJ	6	<b>0 445 120 219</b>	<b>0 986 435 528</b>
<b>18.540</b>	12,4	397	D 2676 LF06 <Euro 5/OBD2>; D 2676 LF13 <Euro 5/OBD1>; D 2676 LF15 <Euro 5/OBD1>	10.07→	DBJ	6	<b>0 445 120 219</b>	<b>0 986 435 528</b>
<b>19.350 WW</b>	10,5	257	D 2066 LF03 <Euro 3>	01.10→	DBJ	6	<b>0 445 120 218</b>	<b>0 986 435 517</b>
<b>19.360 WW</b>	10,5	265	D 2066 LF07 <Euro 2>	01.10→	DBJ	6	<b>0 445 120 218</b>	<b>0 986 435 517</b>
			D 2066 LF64 <Euro 4/OBD2>	02.11→	DBJ	6	<b>0 445 120 217</b>	<b>0 986 435 526</b>
<b>19.390 WW</b>	10,5	287	D 2066 LF02 <Euro 3>	01.10→	DBJ	6	<b>0 445 120 218</b>	<b>0 986 435 517</b>
<b>19.400 WW</b>	10,5	294	D 2066 LF49 <Euro 3>; D 2066 LF63 <Euro 4/OBD2>	02.11→	DBJ	6	<b>0 445 120 217</b>	<b>0 986 435 526</b>
		294/316	D 2066 LF01 <Euro 3>; D 2066 LF06 <Euro 2>	01.10→	DBJ	6	<b>0 445 120 218</b>	<b>0 986 435 517</b>
<b>19.440 WW</b>	10,5	324	D 2066 LF50 <Euro 3>; D 2066 LF62 <Euro 4/OBD2>	02.11→	DBJ	6	<b>0 445 120 217</b>	<b>0 986 435 526</b>
	12,4	324/353	D 2676 LF02 <Euro 3>; D 2676 LF03 <Euro 2>; D 2676 LF04 <Euro 2>	01.10→	DBJ	6	<b>0 445 120 219</b>	<b>0 986 435 528</b>
<b>19.480 WW</b>	12,4	353	D 2676 LF20 <Euro 4/OBD2>	02.11→	DBJ	6	<b>0 445 120 219</b>	<b>0 986 435 528</b>
<b>24.320</b>	10,5	235	D 2066 LF20 <Euro 5/OBD1>; D 2066 LF28 <Euro 5/OBD1>; D 2066 LF39 <Euro 4/OBD1>; D 2066 LF43 <Euro 5/OBD2>; D 2066 LF60 <Euro 5/EEV/OBD2>	10.07→	DBJ	6	<b>0 445 120 217</b>	<b>0 986 435 526</b>
<b>24.360</b>	10,5	265	D 2066 LF19 <Euro 5/OBD1>; D 2066 LF27 <Euro 5/OBD1>; D 2066 LF38 <Euro 4/OBD1>; D 2066 LF42 <Euro 5/OBD2>; D 2066 LF59 <Euro 5/EEV/OBD2>	10.07→	DBJ	6	<b>0 445 120 217</b>	<b>0 986 435 526</b>
<b>24.400</b>	10,5	294	D 2066 LF18 <Euro 5/OBD1>; D 2066 LF26 <Euro 5/OBD1>; D 2066 LF37 <Euro 4/OBD1>; D 2066 LF41 <Euro 5/OBD2>; D 2066 LF58 <Euro 5/EEV/OBD2>	10.07→	DBJ	6	<b>0 445 120 217</b>	<b>0 986 435 526</b>
<b>24.440</b>	10,5	324	D 2066 LF17 <Euro 5/OBD1>; D 2066 LF25 <Euro 5/OBD1>; D 2066 LF36 <Euro 4/OBD1>; D 2066 LF40 <Euro 5/OBD2>; D 2066 LF57 <Euro 5/EEV/OBD2>	10.07→	DBJ	6	<b>0 445 120 217</b>	<b>0 986 435 526</b>
<b>24.480</b> , DF	12,4	353	D 2676 LF05 <Euro 4/OBD1>; D 2676 LF07 <Euro 5/OBD2>; D 2676 LF14 <Euro 5/OBD1>; D 2676 LF16 <Euro 5/OBD1>; D 2676 LF18 <Euro 5/EEV/OBD2>	10.07→	DBJ	6	<b>0 445 120 219</b>	<b>0 986 435 528</b>
<b>24.540</b>	12,4	397	D 2676 LF06 <Euro 5/OBD2>	09.09→	DBJ	6	<b>0 445 120 219</b>	<b>0 986 435 528</b>
<b>26.320</b>	10,5	235	D 2066 LF20 <Euro 5/OBD1>; D 2066 LF28 <Euro 5/OBD1>; D 2066 LF39 <Euro 4/OBD1>; D 2066 LF43 <Euro 5/OBD2>; D 2066 LF60 <Euro 5/EEV/OBD2>	10.07→	DBJ	6	<b>0 445 120 217</b>	<b>0 986 435 526</b>
<b>26.350 WW</b>	10,5	257	D 2066 LF03 <Euro 3>	01.10→	DBJ	6	<b>0 445 120 218</b>	<b>0 986 435 517</b>
<b>26.360</b> , WW	10,5	265	D 2066 LF19 <Euro 5/OBD1>; D 2066 LF27 <Euro 5/OBD1>; D 2066 LF38 <Euro 4/OBD1>; D 2066 LF42 <Euro 5/OBD2>; D 2066 LF59 <Euro 5/EEV/OBD2>; D 2066 LF64 <Euro 4/OBD2>	10.07→	DBJ	6	<b>0 445 120 217</b>	<b>0 986 435 526</b>
<b>26.390 WW</b>	10,5	287	D 2066 LF02 <Euro 3>	01.10→	DBJ	6	<b>0 445 120 218</b>	<b>0 986 435 517</b>





26.400 , WW	10,5	294	D 2066 LF18 <Euro 5/OBD1>; D 2066 LF26 <Euro 5/OBD1>; D 2066 LF37 <Euro 4/OBD1>; D 2066 LF41 <Euro 5/OBD2>; D 2066 LF49 <Euro 3>; D 2066 LF58 <Euro 5/EEV/OBD2>; D 2066 LF63 <Euro 4/OBD2>	10.07→	DBJ	6	0 445 120 217	0 986 435 526
26.430 WW	10,5	316	D 2066 LF01 <Euro 3>	01.10→	DBJ	6	0 445 120 218	0 986 435 517
26.440 , WW	10,5	324	D 2066 LF17 <Euro 5/OBD1>; D 2066 LF25 <Euro 5/OBD1>; D 2066 LF36 <Euro 4/OBD1>; D 2066 LF40 <Euro 5/OBD2>; D 2066 LF50 <Euro 3>; D 2066 LF57 <Euro 5/EEV/OBD2>; D 2066 LF62 <Euro 4/OBD2>	10.07→	DBJ	6	0 445 120 217	0 986 435 526
26.480 , WW	12,4	353	D 2676 LF02 <Euro 3>; D 2676 LF05 <Euro 4/OBD1>; D 2676 LF07 <Euro 5/OBD2>; D 2676 LF14 <Euro 5/OBD1>; D 2676 LF16 <Euro 5/OBD1>; D 2676 LF18 <Euro 5/EEV/OBD2>; D 2676 LF20 <Euro 4/OBD2>	10.07→	DBJ	6	0 445 120 219	0 986 435 528
26.540	12,4	397	D 2676 LF06 <Euro 5/OBD2>; D 2676 LF13 <Euro 5/OBD1>; D 2676 LF15 <Euro 5/OBD1>	10.07→	DBJ	6	0 445 120 219	0 986 435 528
28.320	10,5	235/236	D 2066 LF20 <Euro 5/OBD1>; D 2066 LF28 <Euro 5/OBD1>; D 2066 LF39 <Euro 4/OBD1>; D 2066 LF43 <Euro 5/OBD2>; D 2066 LF60 <Euro 5/EEV/OBD2>	09.07→	DBJ	6	0 445 120 217	0 986 435 526
28.350 WW	10,5	257	D 2066 LF03 <Euro 3>	04.10→	DBJ	6	0 445 120 218	0 986 435 517
28.360 , WW	10,5	265	D 2066 LF19 <Euro 5/OBD1>; D 2066 LF27 <Euro 5/OBD1>; D 2066 LF38 <Euro 4/OBD1>; D 2066 LF42 <Euro 5/OBD2>; D 2066 LF59 <Euro 5/EEV/OBD2>; D 2066 LF64 <Euro 4/OBD2>	09.07→	DBJ	6	0 445 120 217	0 986 435 526
28.390 WW	10,5	287	D 2066 LF02 <Euro 3>	04.10→	DBJ	6	0 445 120 218	0 986 435 517
28.400 , WW	10,5	294	D 2066 LF18 <Euro 5/OBD1>; D 2066 LF26 <Euro 5/OBD1>; D 2066 LF37 <Euro 4/OBD1>; D 2066 LF41 <Euro 5/OBD2>; D 2066 LF49 <Euro 3>; D 2066 LF58 <Euro 5/EEV/OBD2>; D 2066 LF63 <Euro 4/OBD2>	09.07→	DBJ	6	0 445 120 217	0 986 435 526
28.430 WW	10,5	316	D 2066 LF01 <Euro 3>	04.10→	DBJ	6	0 445 120 218	0 986 435 517
28.440 , WW	10,5	324	D 2066 LF17 <Euro 5/OBD1>; D 2066 LF25 <Euro 5/OBD1>; D 2066 LF36 <Euro 4/OBD1>; D 2066 LF40 <Euro 5/OBD2>; D 2066 LF50 <Euro 3>; D 2066 LF57 <Euro 5/EEV/OBD2>; D 2066 LF62 <Euro 4/OBD2>	09.07→	DBJ	6	0 445 120 217	0 986 435 526
28.480 , WW	12,4	353	D 2676 LF02 <Euro 3>; D 2676 LF05 <Euro 4/OBD1>; D 2676 LF07 <Euro 5/OBD2>; D 2676 LF14 <Euro 5/OBD1>; D 2676 LF16 <Euro 5/OBD1>; D 2676 LF18 <Euro 5/EEV/OBD2>; D 2676 LF20 <Euro 4/OBD2>	09.07→	DBJ	6	0 445 120 219	0 986 435 528
28.540	12,4	397	D 2676 LF06 <Euro 5/OBD2>; D 2676 LF13 <Euro 5/OBD1>; D 2676 LF15 <Euro 5/OBD1>	09.07→	DBJ	6	0 445 120 219	0 986 435 528
32.320	10,5	235	D 2066 LF20 <Euro 5/OBD1>; D 2066 LF28 <Euro 5/OBD1>; D 2066 LF39 <Euro 4/OBD1>; D 2066 LF43 <Euro 5/OBD2>; D 2066 LF60 <Euro 5/EEV/OBD2>	10.07→	DBJ	6	0 445 120 217	0 986 435 526
32.360	10,5	265	D 2066 LF19 <Euro 5/OBD1>; D 2066 LF27 <Euro 5/OBD1>; D 2066 LF38 <Euro 4/OBD1>; D 2066 LF42 <Euro 5/OBD2>; D 2066 LF59 <Euro 5/EEV/OBD2>	10.07→	DBJ	6	0 445 120 217	0 986 435 526
32.400	10,5	294	D 2066 LF18 <Euro 5/OBD1>; D 2066 LF26 <Euro 5/OBD1>; D 2066 LF37 <Euro 4/OBD1>; D 2066 LF41 <Euro 5/OBD2>; D 2066 LF58 <Euro 5/EEV/OBD2>	10.07→	DBJ	6	0 445 120 217	0 986 435 526





◀ MAN

<b>32.440</b>	10,5	324	D 2066 LF17 <Euro 5/OBD1>; D 2066 LF25 <Euro 5/OBD1>; D 2066 LF36 <Euro 4/OBD1>; D 2066 LF40 <Euro 5/OBD2>; D 2066 LF57 <Euro 5/EEV/OBD2>	10.07→	DBJ	6	<b>0 445 120 217</b>	<b>0 986 435 526</b>
<b>32.480</b>	12,4	353	D 2676 LF05 <Euro 4/OBD1>; D 2676 LF07 <Euro 5/OBD2>; D 2676 LF14 <Euro 5/OBD1>; D 2676 LF16 <Euro 5/OBD1>; D 2676 LF18 <Euro 5/EEV/OBD2>	10.07→	DBJ	6	<b>0 445 120 219</b>	<b>0 986 435 528</b>
<b>33.320</b>	10,5	235	D 2066 LF20 <Euro 5/OBD1>; D 2066 LF28 <Euro 5/OBD1>; D 2066 LF39 <Euro 4/OBD1>; D 2066 LF43 <Euro 5/OBD2>; D 2066 LF60 <Euro 5/EEV/OBD2>	10.07→	DBJ	6	<b>0 445 120 217</b>	<b>0 986 435 526</b>
<b>33.350 WW</b>	10,5	257	D 2066 LF03 <Euro 3>	01.10→	DBJ	6	<b>0 445 120 218</b>	<b>0 986 435 517</b>
<b>33.360</b>	10,5	265	D 2066 LF19 <Euro 5/OBD1>; D 2066 LF27 <Euro 5/OBD1>; D 2066 LF38 <Euro 4/OBD1>; D 2066 LF42 <Euro 5/OBD2>; D 2066 LF59 <Euro 5/EEV/OBD2>	10.07→	DBJ	6	<b>0 445 120 217</b>	<b>0 986 435 526</b>
WW	10,5	265	D 2066 LF07 <Euro 2>	03.10→	DBJ	6	<b>0 445 120 218</b>	<b>0 986 435 517</b>
			D 2066 LF64 <Euro 4/OBD2>	02.11→	DBJ	6	<b>0 445 120 217</b>	<b>0 986 435 526</b>
<b>33.390 WW</b>	10,5	287	D 2066 LF02 <Euro 3>	01.10→	DBJ	6	<b>0 445 120 218</b>	<b>0 986 435 517</b>
<b>33.400</b>	10,5	294	D 2066 LF18 <Euro 5/OBD1>; D 2066 LF26 <Euro 5/OBD1>; D 2066 LF37 <Euro 4/OBD1>; D 2066 LF41 <Euro 5/OBD2>; D 2066 LF58 <Euro 5/EEV/OBD2>	10.07→	DBJ	6	<b>0 445 120 217</b>	<b>0 986 435 526</b>
WW	10,5	294	D 2066 LF06 <Euro 2>	03.10→	DBJ	6	<b>0 445 120 218</b>	<b>0 986 435 517</b>
			D 2066 LF49 <Euro 3>; D 2066 LF63 <Euro 4/OBD2>	02.11→	DBJ	6	<b>0 445 120 217</b>	<b>0 986 435 526</b>
<b>33.430 WW</b>	10,5	316	D 2066 LF01 <Euro 3>	01.10→	DBJ	6	<b>0 445 120 218</b>	<b>0 986 435 517</b>
<b>33.440 , WW</b>	10,5	324	D 2066 LF17 <Euro 5/OBD1>; D 2066 LF25 <Euro 5/OBD1>; D 2066 LF36 <Euro 4/OBD1>; D 2066 LF40 <Euro 5/OBD2>; D 2066 LF50 <Euro 3>; D 2066 LF57 <Euro 5/EEV/OBD2>; D 2066 LF62 <Euro 4/OBD2>	10.07→	DBJ	6	<b>0 445 120 217</b>	<b>0 986 435 526</b>
WW	12,4	324	D 2676 LF04 <Euro 2>	03.10→	DBJ	6	<b>0 445 120 219</b>	<b>0 986 435 528</b>
<b>33.480 , DF, WW</b>	12,4	353	D 2676 LF02 <Euro 3>; D 2676 LF03 <Euro 2>; D 2676 LF05 <Euro 4/OBD1>; D 2676 LF07 <Euro 5/OBD2>; D 2676 LF14 <Euro 5/OBD1>; D 2676 LF16 <Euro 5/OBD1>; D 2676 LF18 <Euro 5/EEV/OBD2>; D 2676 LF20 <Euro 4/OBD2>	10.07→	DBJ	6	<b>0 445 120 219</b>	<b>0 986 435 528</b>
<b>33.540</b>	12,4	397	D 2676 LF06 <Euro 5/OBD2>; D 2676 LF13 <Euro 5/OBD1>; D 2676 LF15 <Euro 5/OBD1>	10.07→	DBJ	6	<b>0 445 120 219</b>	<b>0 986 435 528</b>
<b>35.320</b>	10,5	235	D 2066 LF20 <Euro 5/OBD1>; D 2066 LF28 <Euro 5/OBD1>; D 2066 LF39 <Euro 4/OBD1>; D 2066 LF43 <Euro 5/OBD2>; D 2066 LF60 <Euro 5/EEV/OBD2>	10.07→	DBJ	6	<b>0 445 120 217</b>	<b>0 986 435 526</b>
<b>35.360 , WW</b>	10,5	265	D 2066 LF19 <Euro 5/OBD1>; D 2066 LF27 <Euro 5/OBD1>; D 2066 LF38 <Euro 4/OBD1>; D 2066 LF42 <Euro 5/OBD2>; D 2066 LF59 <Euro 5/EEV/OBD2>; D 2066 LF64 <Euro 4/OBD2>	10.07→	DBJ	6	<b>0 445 120 217</b>	<b>0 986 435 526</b>
<b>35.390 WW</b>	10,5	287	D 2066 LF02 <Euro 3>	06.10→	DBJ	6	<b>0 445 120 218</b>	<b>0 986 435 517</b>
<b>35.400 , WW</b>	10,5	294	D 2066 LF18 <Euro 5/OBD1>; D 2066 LF26 <Euro 5/OBD1>; D 2066 LF37 <Euro 4/OBD1>; D 2066 LF41 <Euro 5/OBD2>; D 2066 LF49 <Euro 3>; D 2066 LF58 <Euro 5/EEV/OBD2>; D 2066 LF63 <Euro 4/OBD2>	10.07→	DBJ	6	<b>0 445 120 217</b>	<b>0 986 435 526</b>
<b>35.430 WW</b>	10,5	316	D 2066 LF01 <Euro 3>	06.10→	DBJ	6	<b>0 445 120 218</b>	<b>0 986 435 517</b>
<b>35.440 , WW</b>	10,5	324	D 2066 LF17 <Euro 5/OBD1>; D 2066 LF25 <Euro 5/OBD1>; D 2066 LF36 <Euro 4/OBD1>; D 2066 LF40 <Euro 5/OBD2>; D 2066 LF50 <Euro 3>; D 2066 LF57 <Euro 5/EEV/OBD2>; D 2066 LF62 <Euro 4/OBD2>	10.07→	DBJ	6	<b>0 445 120 217</b>	<b>0 986 435 526</b>







35.480 , WW	12,4	353	D 2676 LF02 <Euro 3>; D 2676 LF05 <Euro 4/OBD1>; D 2676 LF07 <Euro 5/OBD2>; D 2676 LF14 <Euro 5/OBD1>; D 2676 LF16 <Euro 5/OBD1>; D 2676 LF18 <Euro 5/EEV/OBD2>; D 2676 LF20 <Euro 4/OBD2>	10.07→	DBJ	6	0 445 120 219	0 986 435 528
35.540	12,4	397	D 2676 LF06 <Euro 5/OBD2>; D 2676 LF13 <Euro 5/OBD1>; D 2676 LF15 <Euro 5/OBD1>	10.07→	DBJ	6	0 445 120 219	0 986 435 528
37.320	10,5	235	D 2066 LF20 <Euro 5/OBD1>; D 2066 LF28 <Euro 5/OBD1>; D 2066 LF39 <Euro 4/OBD1>; D 2066 LF43 <Euro 5/OBD2>; D 2066 LF60 <Euro 5/EEV/OBD2>	10.07→	DBJ	6	0 445 120 217	0 986 435 526
37.360	10,5	265	D 2066 LF19 <Euro 5/OBD1>; D 2066 LF27 <Euro 5/OBD1>; D 2066 LF38 <Euro 4/OBD1>; D 2066 LF42 <Euro 5/OBD2>; D 2066 LF59 <Euro 5/EEV/OBD2>	10.07→	DBJ	6	0 445 120 217	0 986 435 526
37.400	10,5	294	D 2066 LF26 <Euro 5/OBD1>; D 2066 LF37 <Euro 4/OBD1>; D 2066 LF41 <Euro 5/OBD2>; D 2066 LF58 <Euro 5/EEV/OBD2>	10.07→	DBJ	6	0 445 120 217	0 986 435 526
37.440	10,5	324	D 2066 LF17 <Euro 5/OBD1>; D 2066 LF25 <Euro 5/OBD1>; D 2066 LF36 <Euro 4/OBD1>; D 2066 LF40 <Euro 5/OBD2>; D 2066 LF57 <Euro 5/EEV/OBD2>	10.07→	DBJ	6	0 445 120 217	0 986 435 526
37.480	12,4	353	D 2676 LF05 <Euro 4/OBD1>; D 2676 LF07 <Euro 5/OBD2>; D 2676 LF14 <Euro 5/OBD1>; D 2676 LF16 <Euro 5/OBD1>; D 2676 LF18 <Euro 5/EEV/OBD2>	10.07→	DBJ	6	0 445 120 219	0 986 435 528
37.540	12,4	397	D 2676 LF06 <Euro 5/OBD2>; D 2676 LF13 <Euro 5/OBD1>; D 2676 LF15 <Euro 5/OBD1>	10.07→	DBJ	6	0 445 120 219	0 986 435 528
40.360 WW	10,5	265	D 2066 LF07 <Euro 2> D 2066 LF64 <Euro 4/OBD2>	09.11→ 12.11→	DBJ DBJ	6 6	0 445 120 218 0 445 120 217	0 986 435 517 0 986 435 526
40.390 WW	10,5	287	D 2066 LF02 <Euro 3>	03.10→	DBJ	6	0 445 120 218	0 986 435 517
40.400 WW	10,5	294	D 2066 LF06 <Euro 2> D 2066 LF49 <Euro 3>; D 2066 LF63 <Euro 4/OBD2>	03.10→ 02.11→	DBJ DBJ	6 6	0 445 120 218 0 445 120 217	0 986 435 517 0 986 435 526
40.430 WW	10,5	316	D 2066 LF01 <Euro 3>	03.10→	DBJ	6	0 445 120 218	0 986 435 517
40.440 WW	10,5	324	D 2066 LF50 <Euro 3>; D 2066 LF62 <Euro 4/OBD2>	02.11→	DBJ	6	0 445 120 217	0 986 435 526
40.480 WW	12,4	324	D 2676 LF04 <Euro 2>	03.10→	DBJ	6	0 445 120 219	0 986 435 528
40.480 WW	12,4	353	D 2676 LF02 <Euro 3>; D 2676 LF03 <Euro 2>; D 2676 LF20 <Euro 4/OBD2>	03.10→	DBJ	6	0 445 120 219	0 986 435 528
41.320	10,5	235	D 2066 LF20 <Euro 5/OBD1>; D 2066 LF28 <Euro 5/OBD1>; D 2066 LF39 <Euro 4/OBD1>; D 2066 LF43 <Euro 5/OBD2>; D 2066 LF60 <Euro 5/EEV/OBD2>	10.07→	DBJ	6	0 445 120 217	0 986 435 526
41.350 WW	10,5	257	D 2066 LF03 <Euro 3>	01.10→	DBJ	6	0 445 120 218	0 986 435 517
41.360	10,5	265	D 2066 LF19 <Euro 5/OBD1>; D 2066 LF27 <Euro 5/OBD1>; D 2066 LF38 <Euro 4/OBD1>; D 2066 LF42 <Euro 5/OBD2>; D 2066 LF59 <Euro 5/EEV/OBD2>	10.07→	DBJ	6	0 445 120 217	0 986 435 526
WW	10,5	265	D 2066 LF07 <Euro 2> D 2066 LF64 <Euro 4/OBD2>	01.10→ 02.11→	DBJ DBJ	6 6	0 445 120 218 0 445 120 217	0 986 435 517 0 986 435 526
41.390 WW	10,5	287	D 2066 LF02 <Euro 3>	01.10→	DBJ	6	0 445 120 218	0 986 435 517
41.400	10,5	294	D 2066 LF18 <Euro 5/OBD1>; D 2066 LF26 <Euro 5/OBD1>; D 2066 LF37 <Euro 4/OBD1>; D 2066 LF41 <Euro 5/OBD2>; D 2066 LF58 <Euro 5/EEV/OBD2>	10.07→	DBJ	6	0 445 120 217	0 986 435 526
WW	10,5	294	D 2066 LF06 <Euro 2> D 2066 LF49 <Euro 3>; D 2066 LF63 <Euro 4/OBD2>	01.10→ 02.11→	DBJ DBJ	6 6	0 445 120 218 0 445 120 217	0 986 435 517 0 986 435 526
41.430 WW	10,5	316	D 2066 LF01 <Euro 3>	01.10→	DBJ	6	0 445 120 218	0 986 435 517





◀ MAN

<b>41.440</b> , WW	10,5	324	D 2066 LF17 <Euro 5/OBD1>; D 2066 LF25 <Euro 5/OBD1>; D 2066 LF36 <Euro 4/OBD1>; D 2066 LF40 <Euro 5/OBD2>; D 2066 LF50 <Euro 3>; D 2066 LF57 <Euro 5/EEV/OBD2>; D 2066 LF62 <Euro 4/OBD2>	10.07→	DBJ	6	<b>0 445 120 217</b>	<b>0 986 435 526</b>
WW	12,4	324	D 2676 LF04 <Euro 2>	01.10→	DBJ	6	<b>0 445 120 219</b>	<b>0 986 435 528</b>
<b>41.480</b> , WW	12,4	353	D 2676 LF02 <Euro 3>; D 2676 LF03 <Euro 2>; D 2676 LF05 <Euro 4/OBD1>; D 2676 LF07 <Euro 5/OBD2>; D 2676 LF14 <Euro 5/OBD1>; D 2676 LF16 <Euro 5/OBD1>; D 2676 LF18 <Euro 5/EEV/OBD2>; D 2676 LF20 <Euro 4/OBD2>	10.07→	DBJ	6	<b>0 445 120 219</b>	<b>0 986 435 528</b>
<b>41.540</b>	12,4	397	D 2676 LF06 <Euro 5/OBD2>; D 2676 LF13 <Euro 5/OBD1>; D 2676 LF15 <Euro 5/OBD1>	10.07→	DBJ	6	<b>0 445 120 219</b>	<b>0 986 435 528</b>
<b>TGX</b>								
<b>18.360</b>	10,5	265	D 2066 LF19 <Euro 5/OBD1>; D 2066 LF27 <Euro 5/OBD1>; D 2066 LF38 <Euro 4/OBD1>; D 2066 LF42 <Euro 5/OBD2>; D 2066 LF59 <Euro 5/EEV/OBD2>	10.07→	DBJ	6	<b>0 445 120 217</b>	<b>0 986 435 526</b>
<b>18.400</b>	10,5	294	D 2066 LF18 <Euro 5/OBD1>; D 2066 LF26 <Euro 5/OBD1>; D 2066 LF37 <Euro 4/OBD1>; D 2066 LF41 <Euro 5/OBD2>; D 2066 LF58 <Euro 5/EEV/OBD2>	10.07→	DBJ	6	<b>0 445 120 217</b>	<b>0 986 435 526</b>
<b>18.440</b>	10,5	324	D 2066 LF17 <Euro 5/OBD1>; D 2066 LF25 <Euro 5/OBD1>; D 2066 LF36 <Euro 4/OBD1>; D 2066 LF40 <Euro 5/OBD2>; D 2066 LF57 <Euro 5/EEV/OBD2>	10.07→	DBJ	6	<b>0 445 120 217</b>	<b>0 986 435 526</b>
<b>18.480</b> , F, FL	12,4	353	D 2676 LF05 <Euro 4/OBD1>; D 2676 LF07 <Euro 5/OBD2>; D 2676 LF14 <Euro 5/OBD1>; D 2676 LF16 <Euro 5/OBD1>; D 2676 LF18 <Euro 5/EEV/OBD2>	10.07→	DBJ	6	<b>0 445 120 219</b>	<b>0 986 435 528</b>
<b>18.540</b>	12,4	397	D 2676 LF06 <Euro 5/OBD2>; D 2676 LF13 <Euro 5/OBD1>; D 2676 LF15 <Euro 5/OBD1>	10.07→	DBJ	6	<b>0 445 120 219</b>	<b>0 986 435 528</b>
<b>18.680</b>	16,2	500	D 2868 LF02 <Euro 5/OBD1>; D 2868 LF05 <Euro 5/EEV/OBD2>	01.08→	DBJ	8	<b>0 445 120 131</b>	
<b>24.360</b>	10,5	265	D 2066 LF19 <Euro 5/OBD1>; D 2066 LF27 <Euro 5/OBD1>; D 2066 LF38 <Euro 4/OBD1>; D 2066 LF42 <Euro 5/OBD2>; D 2066 LF59 <Euro 5/EEV/OBD2>	10.07→	DBJ	6	<b>0 445 120 217</b>	<b>0 986 435 526</b>
<b>24.400</b>	10,5	294	D 2066 LF18 <Euro 5/OBD1>; D 2066 LF26 <Euro 5/OBD1>; D 2066 LF37 <Euro 4/OBD1>; D 2066 LF41 <Euro 5/OBD2>; D 2066 LF58 <Euro 5/EEV/OBD2>	10.07→	DBJ	6	<b>0 445 120 217</b>	<b>0 986 435 526</b>
<b>24.440</b>	10,5	324	D 2066 LF17 <Euro 5/OBD1>; D 2066 LF25 <Euro 5/OBD1>; D 2066 LF36 <Euro 4/OBD1>; D 2066 LF40 <Euro 5/OBD2>; D 2066 LF57 <Euro 5/EEV/OBD2>	10.07→	DBJ	6	<b>0 445 120 217</b>	<b>0 986 435 526</b>
<b>24.480</b>	12,4	353	D 2676 LF05 <Euro 4/OBD1>; D 2676 LF07 <Euro 5/OBD2>; D 2676 LF14 <Euro 5/OBD1>; D 2676 LF16 <Euro 5/OBD1>; D 2676 LF18 <Euro 5/EEV/OBD2>	10.07→	DBJ	6	<b>0 445 120 219</b>	<b>0 986 435 528</b>
<b>24.540</b>	12,4	397	D 2676 LF06 <Euro 5/OBD2>	09.09→	DBJ	6	<b>0 445 120 219</b>	<b>0 986 435 528</b>
<b>26.360</b>	10,5	265	D 2066 LF19 <Euro 5/OBD1>; D 2066 LF27 <Euro 5/OBD1>; D 2066 LF38 <Euro 4/OBD1>; D 2066 LF42 <Euro 5/OBD2>; D 2066 LF59 <Euro 5/EEV/OBD2>	10.07→	DBJ	6	<b>0 445 120 217</b>	<b>0 986 435 526</b>
<b>26.400</b>	10,5	294	D 2066 LF18 <Euro 5/OBD1>; D 2066 LF26 <Euro 5/OBD1>; D 2066 LF37 <Euro 4/OBD1>; D 2066 LF41 <Euro 5/OBD2>; D 2066 LF58 <Euro 5/EEV/OBD2>	10.07→	DBJ	6	<b>0 445 120 217</b>	<b>0 986 435 526</b>



										
26.440		10,5	324	D 2066 LF17 <Euro 5/OBD1>; D 2066 LF25 <Euro 5/OBD1>; D 2066 LF36 <Euro 4/OBD1>; D 2066 LF40 <Euro 5/OBD2>; D 2066 LF57 <Euro 5/EEV/OBD2>	10.07→		DBJ	6	0 445 120 217	0 986 435 526
26.480		12,4	353	D 2676 LF05 <Euro 4/OBD1>; D 2676 LF07 <Euro 5/OBD2>; D 2676 LF14 <Euro 5/OBD1>; D 2676 LF16 <Euro 5/OBD1>; D 2676 LF18 <Euro 5/EEV/OBD2>	10.07→		DBJ	6	0 445 120 219	0 986 435 528
26.540		12,4	397	D 2676 LF06 <Euro 5/OBD2>; D 2676 LF13 <Euro 5/OBD1>; D 2676 LF15 <Euro 5/OBD1>	10.07→		DBJ	6	0 445 120 219	0 986 435 528
28.360		10,5	265	D 2066 LF19 <Euro 5/OBD1>; D 2066 LF27 <Euro 5/OBD1>; D 2066 LF38 <Euro 4/OBD1>; D 2066 LF42 <Euro 5/OBD2>; D 2066 LF59 <Euro 5/EEV/OBD2>	10.07→		DBJ	6	0 445 120 217	0 986 435 526
28.400		10,5	294	D 2066 LF18 <Euro 5/OBD1>; D 2066 LF26 <Euro 5/OBD1>; D 2066 LF37 <Euro 4/OBD1>; D 2066 LF41 <Euro 5/OBD2>; D 2066 LF58 <Euro 5/EEV/OBD2>	10.07→		DBJ	6	0 445 120 217	0 986 435 526
28.440		10,5	324	D 2066 LF17 <Euro 5/OBD1>; D 2066 LF25 <Euro 5/OBD1>; D 2066 LF36 <Euro 4/OBD1>; D 2066 LF40 <Euro 5/OBD2>; D 2066 LF57 <Euro 5/EEV/OBD2>	10.07→		DBJ	6	0 445 120 217	0 986 435 526
28.480		12,4	353	D 2676 LF05 <Euro 4/OBD1>; D 2676 LF07 <Euro 5/OBD2>; D 2676 LF14 <Euro 5/OBD1>; D 2676 LF18 <Euro 5/EEV/OBD2>	10.07→		DBJ	6	0 445 120 219	0 986 435 528
28.540		12,4	397	D 2676 LF06 <Euro 5/OBD2>; D 2676 LF13 <Euro 5/OBD1>; D 2676 LF15 <Euro 5/OBD1>	10.07→		DBJ	6	0 445 120 219	0 986 435 528
33.360		10,5	265	D 2066 LF19 <Euro 5/OBD1>; D 2066 LF27 <Euro 5/OBD1>; D 2066 LF38 <Euro 4/OBD1>; D 2066 LF42 <Euro 5/OBD2>; D 2066 LF59 <Euro 5/EEV/OBD2>	10.07→		DBJ	6	0 445 120 217	0 986 435 526
33.400		10,5	294	D 2066 LF18 <Euro 5/OBD1>; D 2066 LF26 <Euro 5/OBD1>; D 2066 LF37 <Euro 4/OBD1>; D 2066 LF41 <Euro 5/OBD2>; D 2066 LF58 <Euro 5/EEV/OBD2>	10.07→		DBJ	6	0 445 120 217	0 986 435 526
33.440		10,5	324	D 2066 LF17 <Euro 5/OBD1>; D 2066 LF25 <Euro 5/OBD1>; D 2066 LF36 <Euro 4/OBD1>; D 2066 LF40 <Euro 5/OBD2>; D 2066 LF57 <Euro 5/EEV/OBD2>	10.07→		DBJ	6	0 445 120 217	0 986 435 526
33.480, DF		12,4	353	D 2676 LF05 <Euro 4/OBD1>; D 2676 LF07 <Euro 5/OBD2>; D 2676 LF14 <Euro 5/OBD1>; D 2676 LF16 <Euro 5/OBD1>; D 2676 LF18 <Euro 5/EEV/OBD2>	10.07→		DBJ	6	0 445 120 219	0 986 435 528
33.540		12,4	397	D 2676 LF06 <Euro 5/OBD2>; D 2676 LF13 <Euro 5/OBD1>; D 2676 LF15 <Euro 5/OBD1>	10.07→		DBJ	6	0 445 120 219	0 986 435 528
33.680		16,2	500	D 2868 LF02 <Euro 5/OBD1>; D 2868 LF05 <Euro 5/EEV/OBD2>	01.08→		DBJ	8	0 445 120 131	
35.360		10,5	265	D 2066 LF19 <Euro 5/OBD1>; D 2066 LF27 <Euro 5/OBD1>; D 2066 LF38 <Euro 4/OBD1>; D 2066 LF42 <Euro 5/OBD2>; D 2066 LF59 <Euro 5/EEV/OBD2>	09.07→		DBJ	6	0 445 120 217	0 986 435 526
35.400		10,5	294	D 2066 LF18 <Euro 5/OBD1>; D 2066 LF26 <Euro 5/OBD1>; D 2066 LF37 <Euro 4/OBD1>; D 2066 LF41 <Euro 5/OBD2>; D 2066 LF58 <Euro 5/EEV/OBD2>	09.07→		DBJ	6	0 445 120 217	0 986 435 526
35.440		10,5	324	D 2066 LF17 <Euro 5/OBD1>; D 2066 LF25 <Euro 5/OBD1>; D 2066 LF36 <Euro 4/OBD1>; D 2066 LF40 <Euro 5/OBD2>; D 2066 LF57 <Euro 5/EEV/OBD2>	09.07→		DBJ	6	0 445 120 217	0 986 435 526
35.480		12,4	353	D 2676 LF05 <Euro 4/OBD1>; D 2676 LF07 <Euro 5/OBD2>; D 2676 LF14 <Euro 5/OBD1>; D 2676 LF16 <Euro 5/OBD1>; D 2676 LF18 <Euro 5/EEV/OBD2>	09.07→		DBJ	6	0 445 120 219	0 986 435 528





◀ MAN

<b>35.540</b>	12,4	397	D 2676 LF06 <Euro 5/OBD2>; D 2676 LF13 <Euro 5/OBD1>; D 2676 LF15 <Euro 5/OBD1>	09.07→	DBJ	6	<b>0 445 120 219</b>	<b>0 986 435 528</b>
<b>41.540</b>	12,4	397	D 2676 LF06 <Euro 5/OBD2>; D 2676 LF13 <Euro 5/OBD1>; D 2676 LF15 <Euro 5/OBD1>	10.07→	DBJ	6	<b>0 445 120 219</b>	<b>0 986 435 528</b>
<b>41.680</b>	16,2	500	D 2868 LF03 <Euro 5/OBD1>; D 2868 LF06 <Euro 5/OBD2>	01.08→	DBJ	8	<b>0 445 120 131</b>	

**MAZ MINSK**

<b>Serie 100</b>								
<b>103</b>	7,1	161,5/169	D 260.5 E2 <Euro 2>; D 260.5 E3 <Euro 3>	01.02→	DBJ	6	<b>0 445 120 141</b>	
<b>10t</b>								
<b>437041</b>	4,8	115	D 245.30 E3 <Euro 3>	01.08→	DBJ	4	<b>0 445 120 141</b>	
<b>457043</b>	4,8	115	D 245.30 E3 <Euro 3>	01.08→	DBJ	4	<b>0 445 120 141</b>	
<b>13t</b>								
<b>438043</b>	4,8	130	D245.35 E4 <Euro 4>	12.11→	DBJ	4	<b>0 445 120 245</b>	
<b>18t</b>								
<b>5440A9</b>	11,1	303	650.10 <Euro 3>	01.02→	DBJ	6	<b>0 445 120 142</b>	
<b>555147</b>	7,1	169	D 260.5 E3 <Euro 3>	01.08→	DBJ	6	<b>0 445 120 141</b>	

**MERCEDES-BENZ**

<b>Actros</b>								
<b>1842 [963]</b>	12,8	310	OM 471... <EEV, Euro 5/6> Mot.Typ 471.900 Mot.Typ 471.909	09.11→ 09.11→		6 6	<b>0 445 120 270</b> <b>0 445 120 287</b>	
<b>1845 [963]</b>	12,8	330	OM 471... <EEV, Euro 5/6> Mot.Typ 471.900 Mot.Typ 471.909	09.11→ 09.11→		6 6	<b>0 445 120 270</b> <b>0 445 120 287</b>	
<b>1848 [963]</b>	12,8	350	OM 471... <Euro 6> Mot.Typ 471.900 Mot.Typ 471.909	09.11→ 09.11→		6 6	<b>0 445 120 270</b> <b>0 445 120 287</b>	
<b>1851 [963]</b>	12,8	375	OM 471... <EEV, Euro 5/6> Mot.Typ 471.900 Mot.Typ 471.909	09.11→ 09.11→		6 6	<b>0 445 120 270</b> <b>0 445 120 287</b>	
<b>2542 [963]</b>	12,8	310	OM 471... <EEV, Euro 5/6> Mot.Typ 471.900 Mot.Typ 471.909	09.11→ 09.11→		6 6	<b>0 445 120 270</b> <b>0 445 120 287</b>	
<b>2545 [963]</b>	12,8	330	OM 471... <EEV, Euro 5/6> Mot.Typ 471.900 Mot.Typ 471.909	09.11→ 09.11→		6 6	<b>0 445 120 270</b> <b>0 445 120 287</b>	
<b>2548 [963]</b>	12,8	350	OM 471... <Euro 6> Mot.Typ 471.900 Mot.Typ 471.909	09.11→ 09.11→		6 6	<b>0 445 120 270</b> <b>0 445 120 287</b>	
<b>2551 [963]</b>	12,8	375	OM 471... <EEV, Euro 5/6> Mot.Typ 471.900 Mot.Typ 471.909	09.11→ 09.11→		6 6	<b>0 445 120 270</b> <b>0 445 120 287</b>	
<b>Sprinter</b>								
<b>208 CDI [T1N]</b>	2,2	60	OM 611.987 DE LA Mot.Nr. →..427374 Mot.Nr. ...427375→..498369 Mot.Nr. ...498370→	04.00-05.06 04.00-05.06 04.00-05.06 04.00-05.06	DBB,EU2 AGF,DBB DBB,EU3 DBB,EU3, TW	4 4 4 4	<b>0 445 110 034</b> <b>0 445 110 024</b> <b>0 445 110 069</b> <b>0 445 110 203</b> <b>0 445 110 107</b> <b>0 445 110 189</b> <b>0 986 435 012</b> <b>0 986 435 020</b> <b>0 986 435 158</b> <b>0 986 435 065</b> <b>0 986 435 047</b> <b>0 986 435 055</b>	
<b>209 CDI [NCV3]</b>	2,1	65	OM 646.984 DE 22 LA <Euro 4>	04.06-03.09	DBB	4	<b>0 445 115 068</b>	<b>0 986 435 356</b>





<b>211</b> CDI [NCV3]	2,1	80	OM 646.985 DE 22 LA <Euro 4>	04.06→	DBB	4	<b>0 445 115 068</b>	<b>0 986 435 356</b>
CDI [T1N]	2,2	80	OM 611.981 DE LA	04.00-05.06	DBB,EU2	4	<b>0 445 110 095</b>	<b>0 986 435 037</b>
					AGF,DBB	4	<b>0 445 110 024</b>	<b>0 986 435 020</b>
			Mot.Nr. ...427375→...498369	04.00-05.06	DBB,EU3	4	<b>0 445 110 203</b>	<b>0 986 435 065</b>
					DBB,EU3, WW	4	<b>0 445 110 069</b>	<b>0 986 435 158</b>
			Mot.Nr. ...498370→	04.00-05.06	DBB,EU3, TW	4	<b>0 445 110 107</b>	<b>0 986 435 047</b>
						4	<b>0 445 110 189</b>	<b>0 986 435 055</b>
<b>213</b> CDI [NCV3]	2,1	95	OM 646.986 DE 22 LA <Euro 4>	04.06-03.09	DBB	4	<b>0 445 115 068</b>	<b>0 986 435 356</b>
CDI [T1N]	2,2	95	OM 611.981 DE LA	04.00-05.06	DBB,EU2	4	<b>0 445 110 095</b>	<b>0 986 435 037</b>
					AGF,DBB	4	<b>0 445 110 024</b>	<b>0 986 435 020</b>
			Mot.Nr. ...427375→...498369	04.00-05.06	DBB,EU3	4	<b>0 445 110 203</b>	<b>0 986 435 065</b>
					DBB,EU3, WW	4	<b>0 445 110 069</b>	<b>0 986 435 158</b>
			Mot.Nr. ...498370→	04.00-05.06	DBB,EU3, TW	4	<b>0 445 110 107</b>	<b>0 986 435 047</b>
						4	<b>0 445 110 189</b>	<b>0 986 435 055</b>
<b>215</b> CDI [NCV3]	2,1	110	OM 646... <Euro 4>	04.06→	DBB	4	<b>0 445 110 294</b>	<b>0 986 435 159</b>
<b>216</b> CDI [T1N]	2,7	115	OM 612.981 DE LA	04.00-05.06	DBB,N13	5	<b>0 445 110 069</b>	<b>0 986 435 158</b>
					AGF,DBB	5	<b>0 445 110 024</b>	<b>0 986 435 020</b>
			Mot.Nr. →...427378	04.00-05.06	DBB,EU2, EU3	5	<b>0 445 110 095</b>	<b>0 986 435 037</b>
			Mot.Nr. →...498369	04.00-05.06	DBB,EU3, TW	5	<b>0 445 110 105</b>	<b>0 986 435 045</b>
			Mot.Nr. ...427379→...499018	04.00-05.06	DBB,EU3	5	<b>0 445 110 203</b>	<b>0 986 435 065</b>
			Mot.Nr. ...498370→	04.00-05.06	DBB,EU3, TW	5	<b>0 445 110 170</b>	<b>0 986 435 164</b>
						5	<b>0 445 110 181</b>	<b>0 986 435 053</b>
			Mot.Nr. ...499019→	04.00-05.06	DBB,EU3, TW	5	<b>0 445 110 107</b>	<b>0 986 435 047</b>
						5	<b>0 445 110 189</b>	<b>0 986 435 055</b>
<b>218</b> CDI [NCV3]	3,0	135	OM 642... <Euro 4>					
			Mot.Nr. →...40820980	04.06-11.08	DBB	6	<b>0 445 115 063</b>	<b>0 986 435 355</b>
			Mot.Nr. ...40820981→	12.08-03.09	<del>DBB</del>	6	<b>0 445 115 075</b>	
<b>219</b> CDI [NCV3]	3,0	140	OM 642.992 DE 30 LA <Euro 5>	03.09→	<del>DBB</del>	6	<b>0 445 115 075</b>	
<b>308</b> CDI [T1N]	2,2	60	OM 611.987 DE LA	04.00-05.06	DBB,EU2	4	<b>0 445 110 034</b>	<b>0 986 435 012</b>
					AGF,DBB	4	<b>0 445 110 024</b>	<b>0 986 435 020</b>
			Mot.Nr. →...427374	04.00-05.06	DBB,EU3	4	<b>0 445 110 069</b>	<b>0 986 435 158</b>
			Mot.Nr. ...427375→...498369	04.00-05.06	DBB,EU3	4	<b>0 445 110 203</b>	<b>0 986 435 065</b>
			Mot.Nr. ...498370→	04.00-05.06	DBB,EU3, TW	4	<b>0 445 110 107</b>	<b>0 986 435 047</b>
						4	<b>0 445 110 189</b>	<b>0 986 435 055</b>
<b>309</b> CDI [NCV3]	2,1	65	OM 646.984 DE 22 LA <Euro 4>	04.06-03.09	DBB	4	<b>0 445 115 068</b>	<b>0 986 435 356</b>
<b>311</b> CDI	2,2	80	OM 611 LA					
			Komp.Nr. 522647/06	06.01-12.04	DBB	4	<b>0 445 110 181</b>	<b>0 986 435 053</b>
			Komp.Nr. 522647/07/08	06.01-12.04	DBB	4	<b>0 445 110 189</b>	<b>0 986 435 055</b>
			Komp.Nr. 522647/10	06.01-12.04	DBB	4	<b>0 445 110 203</b>	<b>0 986 435 065</b>
CDI [NCV3]	2,1	80	OM 646.985 DE 22 LA <Euro 4>	04.06→	DBB	4	<b>0 445 115 068</b>	<b>0 986 435 356</b>
CDI [T1N]	2,1	80	OM 611.981 DE LA	08.02-05.06	DBB,EU2	4	<b>0 445 110 095</b>	<b>0 986 435 037</b>
					AGF,DBB	4	<b>0 445 110 024</b>	<b>0 986 435 020</b>
			Mot.Nr. ...427375→...498369	08.02-05.06	DBB,EU3	4	<b>0 445 110 203</b>	<b>0 986 435 065</b>
					DBB,EU3, WW	4	<b>0 445 110 069</b>	<b>0 986 435 158</b>
			Mot.Nr. ...498370→	08.02-05.06	DBB,EU3, TW	4	<b>0 445 110 107</b>	<b>0 986 435 047</b>
						4	<b>0 445 110 189</b>	<b>0 986 435 055</b>
	2,2	80	OM 611.981 DE LA	04.00-05.06	DBB,EU2	4	<b>0 445 110 095</b>	<b>0 986 435 037</b>
					AGF,DBB	4	<b>0 445 110 024</b>	<b>0 986 435 020</b>
			Mot.Nr. ...427375→...498369	04.00-05.06	DBB,EU3	4	<b>0 445 110 203</b>	<b>0 986 435 065</b>
					DBB,EU3, WW	4	<b>0 445 110 069</b>	<b>0 986 435 158</b>
			Mot.Nr. ...498370→	04.00-05.06	DBB,EU3, TW	4	<b>0 445 110 107</b>	<b>0 986 435 047</b>
						4	<b>0 445 110 189</b>	<b>0 986 435 055</b>
CDI Street	2,2	95	OM 611 LA	01.09→	DBB	4	<b>0 445 110 189</b>	<b>0 986 435 055</b>
<b>313</b> CDI	2,2	95	OM 611 LA					
			Komp.Nr. 522647/06	06.01→	DBB	4	<b>0 445 110 181</b>	<b>0 986 435 053</b>
			Komp.Nr. 522647/07/08	06.01→	DBB	4	<b>0 445 110 189</b>	<b>0 986 435 055</b>
			Komp.Nr. 522647/10	06.01→	DBB	4	<b>0 445 110 203</b>	<b>0 986 435 065</b>





◀ MERCEDES-BENZ

<b>313</b> CDI [NCV3]	2,1	95	OM 646.986 DE 22 LA <Euro 4>	04.06-03.09	DBB	4	<b>0 445 115 068</b>	<b>0 986 435 356</b>
CDI [T1N]	2,2	95	OM 611.981 DE LA	04.00-05.06	DBB,EU2	4	<b>0 445 110 095</b>	<b>0 986 435 037</b>
			Mot.Nr. ...427375→..498369	04.00-05.06	AGF,DBB	4	<b>0 445 110 024</b>	<b>0 986 435 020</b>
				04.00-05.06	DBB,EU3	4	<b>0 445 110 203</b>	<b>0 986 435 065</b>
					DBB,EU3, WW	4	<b>0 445 110 069</b>	<b>0 986 435 158</b>
			Mot.Nr. ...498370→	04.00-05.06	DBB,EU3	4	<b>0 445 110 107</b>	<b>0 986 435 047</b>
				08.02-05.06	DBB,EU3, TW	4	<b>0 445 110 107</b>	<b>0 986 435 047</b>
					TW	4	<b>0 445 110 189</b>	<b>0 986 435 055</b>
<b>315</b> CDI [NCV3]	2,1	110	OM 646... <Euro 4>	04.06→	DBB	4	<b>0 445 110 294</b>	<b>0 986 435 159</b>
<b>316</b> CDI [T1N]	2,7	115	OM 647.981 DE 27 LA	10.04-05.06	DBB	5	<b>0 445 110 162</b>	<b>0 986 435 109</b>
CDI, CDI James Cook [T1N]	2,7	115	OM 612.981 DE LA	04.00-05.06	DBB,N13	5	<b>0 445 110 069</b>	<b>0 986 435 158</b>
					AGF,DBB	5	<b>0 445 110 024</b>	<b>0 986 435 020</b>
			Mot.Nr. →..427378	04.00-05.06	DBB,EU2, EU3	5	<b>0 445 110 095</b>	<b>0 986 435 037</b>
			Mot.Nr. →..498369	04.00-05.06	DBB,EU3, TW	5	<b>0 445 110 105</b>	<b>0 986 435 045</b>
			Mot.Nr. ...427379→..499018	04.00-05.06	DBB,EU3	5	<b>0 445 110 203</b>	<b>0 986 435 065</b>
			Mot.Nr. ...498370→	04.00-05.06	DBB,EU3, TW	5	<b>0 445 110 170</b>	<b>0 986 435 164</b>
					TW	5	<b>0 445 110 181</b>	<b>0 986 435 053</b>
			Mot.Nr. ...499019→	04.00-05.06	DBB,EU3, TW	5	<b>0 445 110 107</b>	<b>0 986 435 047</b>
					TW	5	<b>0 445 110 189</b>	<b>0 986 435 055</b>
<b>318</b> CDI [NCV3]	3,0	135	OM 642... <Euro 4>					
			Mot.Nr. →..40820980	04.06-11.08	DBB	6	<b>0 445 115 063</b>	<b>0 986 435 355</b>
			Mot.Nr. ...40820981→	12.08-03.09	DBJ	6	<b>0 445 115 075</b>	
<b>319</b> CDI [NCV3]	3,0	140	OM 642.992 DE 30 LA <Euro 5>	03.09→	DBJ	6	<b>0 445 115 075</b>	
<b>408</b> CDI [T1N]	2,2	60	OM 611.987 DE LA	04.00-05.06	DBB,EU2	4	<b>0 445 110 034</b>	<b>0 986 435 012</b>
					AGF,DBB	4	<b>0 445 110 024</b>	<b>0 986 435 020</b>
			Mot.Nr. →..427374	04.00-05.06	DBB,EU3	4	<b>0 445 110 069</b>	<b>0 986 435 158</b>
			Mot.Nr. ...427375→..498369	04.00-05.06	DBB,EU3	4	<b>0 445 110 203</b>	<b>0 986 435 065</b>
			Mot.Nr. ...498370→	04.00-05.06	DBB,EU3, TW	4	<b>0 445 110 107</b>	<b>0 986 435 047</b>
					TW	4	<b>0 445 110 189</b>	<b>0 986 435 055</b>
<b>411</b> CDI [NCV3]	2,1	80	OM 646.985 DE 22 LA <Euro 4>	04.06-03.09	DBB	4	<b>0 445 115 068</b>	<b>0 986 435 356</b>
CDI [T1N]	2,2	80	OM 611.981 DE LA	04.00-05.06	DBB,EU2	4	<b>0 445 110 095</b>	<b>0 986 435 037</b>
					AGF,DBB	4	<b>0 445 110 024</b>	<b>0 986 435 020</b>
			Mot.Nr. ...427375→..498369	04.00-05.06	DBB,EU3	4	<b>0 445 110 203</b>	<b>0 986 435 065</b>
					DBB,EU3, WW	4	<b>0 445 110 069</b>	<b>0 986 435 158</b>
			Mot.Nr. ...498370→	04.00-05.06	DBB,EU3, TW	4	<b>0 445 110 107</b>	<b>0 986 435 047</b>
					TW	4	<b>0 445 110 189</b>	<b>0 986 435 055</b>
<b>413</b> CDI	2,2	95	OM 611 LA					
			Komp.Nr. 522647/06	06.01→	DBB	4	<b>0 445 110 181</b>	<b>0 986 435 053</b>
			Komp.Nr. 522647/07/08	06.01→	DBB	4	<b>0 445 110 189</b>	<b>0 986 435 055</b>
			Komp.Nr. 522647/10	06.01→	DBB	4	<b>0 445 110 203</b>	<b>0 986 435 065</b>
CDI [T1N]	2,2	95	OM 611.981 DE LA	04.00-05.06	DBB,EU2	4	<b>0 445 110 095</b>	<b>0 986 435 037</b>
					AGF,DBB	4	<b>0 445 110 024</b>	<b>0 986 435 020</b>
			Mot.Nr. ...427375→..498369	04.00-05.06	DBB,EU3	4	<b>0 445 110 203</b>	<b>0 986 435 065</b>
					DBB,EU3, WW	4	<b>0 445 110 069</b>	<b>0 986 435 158</b>
			Mot.Nr. ...498370→	04.00-05.06	DBB,EU3, TW	4	<b>0 445 110 107</b>	<b>0 986 435 047</b>
					TW	4	<b>0 445 110 189</b>	<b>0 986 435 055</b>
<b>415</b> CDI [NCV3]	2,1	110	OM 646... <Euro 4>	04.06-03.09	DBB	4	<b>0 445 110 294</b>	<b>0 986 435 159</b>
<b>416</b> CDI [T1N]	2,7	115	OM 612.981 DE LA	04.00-05.06	DBB,N13	5	<b>0 445 110 069</b>	<b>0 986 435 158</b>
					AGF,DBB	5	<b>0 445 110 024</b>	<b>0 986 435 020</b>
			Mot.Nr. →..427378	04.00-05.06	DBB,EU2, EU3	5	<b>0 445 110 095</b>	<b>0 986 435 037</b>
			Mot.Nr. →..498369	04.00-05.06	DBB,EU3, TW	5	<b>0 445 110 105</b>	<b>0 986 435 045</b>
			Mot.Nr. ...427379→..499018	04.00-05.06	DBB,EU3	5	<b>0 445 110 203</b>	<b>0 986 435 065</b>
			Mot.Nr. ...498370→	04.00-05.06	DBB,EU3, TW	5	<b>0 445 110 170</b>	<b>0 986 435 164</b>
					TW	5	<b>0 445 110 181</b>	<b>0 986 435 053</b>
			Mot.Nr. ...499019→	04.00-05.06	DBB,EU3, TW	5	<b>0 445 110 107</b>	<b>0 986 435 047</b>
					TW	5	<b>0 445 110 189</b>	<b>0 986 435 055</b>
			OM 647.981 DE 27 LA	10.04-05.06	DBB	5	<b>0 445 110 162</b>	<b>0 986 435 109</b>





<b>418</b> CDI [NCV3]	3,0	135	OM 642... <Euro 4>							
			Mot.Nr. →..40820980	04.06-11.08	DBB	6	<b>0 445 115 063</b>	<b>0 986 435 355</b>		
			Mot.Nr. ..40820981→	12.08-03.09	<del>DBB</del>	6	<b>0 445 115 075</b>			
<b>419</b> CDI [NCV3]	3,0	140	OM 642.992 DE 30 LA <Euro 5>	03.09→	<del>DBB</del>	6	<b>0 445 115 075</b>			
<b>509</b> CDI [NCV3]	2,1	65	OM 646.984 DE 22 LA <Euro 4>	04.06-03.09	DBB	4	<b>0 445 115 068</b>	<b>0 986 435 356</b>		
<b>511</b> CDI [NCV3]	2,1	80	OM 646.985 DE 22 LA <Euro 4>	04.06-03.09	DBB	4	<b>0 445 115 068</b>	<b>0 986 435 356</b>		
<b>515</b> CDI [NCV3]	2,1	110	OM 646... <Euro 4>							
			Mot.Typ 646.986	04.06-03.09	DBB	4	<b>0 445 115 068</b>	<b>0 986 435 356</b>		
			Mot.Typ 646.990	04.06-03.09	DBB	4	<b>0 445 110 294</b>	<b>0 986 435 159</b>		
<b>518</b> CDI [NCV3]	3,0	135	OM 642... <Euro 4>							
			Mot.Nr. →..40820980	04.06-11.08	DBB	6	<b>0 445 115 063</b>	<b>0 986 435 355</b>		
			Mot.Nr. ..40820981→	12.08-03.09	<del>DBB</del>	6	<b>0 445 115 075</b>			
<b>519</b> CDI [NCV3]	3,0	140	OM 642.992 DE 30 LA <Euro 5>	03.09→	<del>DBB</del>	6	<b>0 445 115 075</b>			
<b>616</b> CDI [T1N]	2,7	115	OM 612.981 DE LA	02.01-05.06	DBB,N13	5	<b>0 445 110 069</b>	<b>0 986 435 158</b>		
					AGF,DBB	5	<b>0 445 110 024</b>	<b>0 986 435 020</b>		
			Mot.Nr. →..427378	02.01-05.06	DBB,EU2,EU3	5	<b>0 445 110 095</b>	<b>0 986 435 037</b>		
			Mot.Nr. →..498369	02.01-05.06	DBB,EU3, TW	5	<b>0 445 110 105</b>	<b>0 986 435 045</b>		
			Mot.Nr. ..427379→..499018	02.01-05.06	DBB,EU3	5	<b>0 445 110 203</b>	<b>0 986 435 065</b>		
			Mot.Nr. ..498370→	02.01-05.06	DBB,EU3, TW	5	<b>0 445 110 170</b>	<b>0 986 435 164</b>		
					5	<b>0 445 110 181</b>	<b>0 986 435 053</b>			
			Mot.Nr. ..499019→	02.01-05.06	DBB,EU3, TW	5	<b>0 445 110 107</b>	<b>0 986 435 047</b>		
					5	<b>0 445 110 189</b>	<b>0 986 435 055</b>			
<b>Vito</b>										
<b>108</b> CDI [638 TON]	2,2	60	OM 611.980							
			Mot.Nr. →..220722	04.99-09.03	DBB,EU3	4	<b>0 445 110 105</b>	<b>0 986 435 045</b>		
					DBB,EU3	4	<b>0 445 110 011</b>	<b>0 986 435 004</b>		
			Mot.Nr. ..220723→	04.99-09.03	DBB,EU3	4	<b>0 445 110 181</b>	<b>0 986 435 053</b>		
					DBB,EU3	4	<b>0 445 110 201</b>	<b>0 986 435 063</b>		
<b>109</b> CDI [639 TON]	2,1	65	OM 646.983 <OM 646 DE22LA>							
			Mot.Nr. →50202886	10.03-10.06	DBB,EU3	4	<b>0 445 110 139</b>	<b>0 986 435 107</b>		
			Mot.Nr. 50202887→	10.03-10.06	DBB,EU3	4	<b>0 445 110 263</b>	<b>0 986 435 115</b>		
		70	OM 646.980 <OM 646 DE22LA>	11.06-07.10	DBB	4	<b>0 445 115 068</b>	<b>0 986 435 356</b>		
<b>110</b> CDI [638 TON]	2,2	75	OM 611.980							
			Mot.Nr. →..220722	04.99-09.03	DBB,EU3	4	<b>0 445 110 105</b>	<b>0 986 435 045</b>		
					DBB,EU3	4	<b>0 445 110 011</b>	<b>0 986 435 004</b>		
			Mot.Nr. ..220723→	04.99-09.03	DBB,EU3	4	<b>0 445 110 181</b>	<b>0 986 435 053</b>		
					DBB,EU3	4	<b>0 445 110 201</b>	<b>0 986 435 063</b>		
<b>111</b> CDI [639 TON]	2,1	80	OM 646.982 <OM 646 DE22LA>	10.03-10.06	DBB,EU4	4	<b>0 445 110 191</b>	<b>0 986 435 113</b>		
								<b>0 986 435 114</b>		
			Mot.Nr. →50202886	10.03-10.06	DBB,EU3	4	<b>0 445 110 139</b>	<b>0 986 435 107</b>		
			Mot.Nr. 50202887→	10.03-10.06	DBB,EU3	4	<b>0 445 110 263</b>	<b>0 986 435 115</b>		
		85	OM 646.981 <OM 646 DE22LA>	11.06-07.10	DBB	4	<b>0 445 115 068</b>	<b>0 986 435 356</b>		
<b>112</b> CDI [638 TON]	2,2	90	OM 611.980							
			Mot.Nr. →..220722	04.99-09.03	DBB,EU3	4	<b>0 445 110 105</b>	<b>0 986 435 045</b>		
					DBB,EU3	4	<b>0 445 110 011</b>	<b>0 986 435 004</b>		
			Mot.Nr. ..220723→	04.99-09.03	DBB,EU3	4	<b>0 445 110 181</b>	<b>0 986 435 053</b>		
					DBB,EU3	4	<b>0 445 110 201</b>	<b>0 986 435 063</b>		
<b>115</b> CDI [639 TON]	2,1	110	OM 646.982 <OM 646 DE22LA>	10.03-07.10	DBB,EU4	4	<b>0 445 110 191</b>	<b>0 986 435 113</b>		
								<b>0 986 435 114</b>		
			Mot.Nr. →50202886	10.03-07.10	DBB,EU3	4	<b>0 445 110 139</b>	<b>0 986 435 107</b>		
			Mot.Nr. 50202887→	10.03-07.10	DBB,EU3	4	<b>0 445 110 263</b>	<b>0 986 435 115</b>		
<b>120</b> CDI [639 TON]	3,0	150	642.990 <OM 642 DE30LA>							
			Mot.Nr. →40820980	04.06-11.08	DBB	6	<b>0 445 115 063</b>	<b>0 986 435 355</b>		
			Mot.Nr. ..40820981→	12.08-07.10	<del>DBB</del>	6	<b>0 445 115 075</b>			
<b>122</b> CDI [639 TON]	3,0	165	OM 642 DE 30 LA <Euro 5>	07.10→	<del>DBB</del>	6	<b>0 445 115 075</b>			





**MITSUBISHI**

<b>Canter 35</b>							
3C 11, 13, 15 [FB]	3,0	81/92/107	4M42-T1 <Euro 4>; 4M42-T2 <Euro 4>; 4M42-T4 <Euro 4>	04.06→	DBJ	4	0 445 120 073
3S 11, 13 [FE]	3,0	81/92	4M42-T1 <Euro 4>; 4M42-T2 <Euro 4>	04.06→	DBJ	4	0 445 120 073
<b>Canter 55</b>							
5S 13 [FE]	3,0	92	4M42-3A T2 <Euro 4>	04.06→	DBJ	4	0 445 120 073
<b>Canter 65</b>							
6C 15 [FE]	3,0	107	4M42-3A T4 <Euro 4>	04.06→	DBJ	4	0 445 120 073
18 [FE]	4,9	132	4M50-T5 <Euro 4>	08.06→	DBJ	4	0 445 120 072
<b>Canter 75</b>							
7C 15 [FE]	3,0	107	4M42-3A T4 <Euro 4>	04.06→	DBJ	4	0 445 120 073
18 [FE]	4,9	132	4M50-T5 <Euro 4>	08.06→	DBJ	4	0 445 120 072

**MITSUBISHI FUSO TRUCK & BUS CO**

<b>Canter</b>							
3.0 D Turbo	3,0	81/92/107	4M42-3AT1 <Euro 4>; 4M42-3AT2 <Euro 4>; 4M42-3AT4 <Euro 4>	04.06→	DBJ	4	0 445 120 073
4.9 D Turbo	4,9	110	4M50-7AT7 <Euro 3>	11.09→	DBJ	4	0 445 120 049
		132	4M50-T5 <Euro 4>	04.06→	DBJ	4	0 445 120 072

**MZKT**

<b>42t</b>							
700600	11,1	303	650.10 <Euro 3>	01.10→	DBJ	6	0 445 120 142

**NEFAZ NEFTEKAMSK**

<b>Serie 5000</b>							
5297	5,9	184	6ISBe 250.30 <Euro 3>	01.00→	DBJ,TW	6	0 445 120 123
						6	0 445 120 212 0 986 435 508
5299	6,7	184	6ISBe 250.30 <Euro 3>	01.08→	DBJ,TW	6	0 445 120 123
						6	0 445 120 212 0 986 435 508
		198	6ISBe 270B <Euro 3>	01.08→	DBJ,TW	6	0 445 120 123
						6	0 445 120 212 0 986 435 508

**NISSAN**

<b>Interstar</b>							
1.9 D Turbo dCi 80 [X70]	1,9	59-60	F9Q... Mot.Nr. F9Q 774	07.02→	DBB	4	0 445 110 110 0 986 435 080
2.2 D Turbo dCi 90 [X70]	2,2	66	G9T...	07.02→	DBJ	4	0 445 110 102 0 986 435 106
2.5 D Turbo dCi 100 [X70]	2,5	73-74	G9U... Mot.Nr. G9U 650	11.03→	DBB	4	0 445 110 265 0 986 435 170
			Mot.Nr. G9U 754	11.03→	DBJ	4	0 445 110 141 0 986 435 086
D Turbo dCi 120 [X70]	2,5	84-88	G9U... Mot.Nr. G9U 632	07.02→	DBB	4	0 445 110 265 0 986 435 170
			Mot.Nr. G9U 650				
			Mot.Nr. G9U 720	07.02→	DBJ,TW	4	0 445 110 087 0 986 435 079
			Mot.Nr. G9U 750				
			Mot.Nr. G9U 724	07.02→	DBJ	4	0 445 110 141 0 986 435 086
			Mot.Nr. G9U 754				

<b>Primastar</b>							
2.0 dCi 90, dCi 115 [X83]	2,0	66/84-85	M9R...	10.06→	DBJ	4	0 445 115 022
2.5 dCi 140 [X83]	2,5	99	G9U 730	09.03→	DBJ	4	0 445 110 087 0 986 435 079
dCi 150 [X83]	2,5	107-110	G9U 630	10.06→	DBB	4	0 445 110 265 0 986 435 170







**OPEL**

<b>Movano</b>									
1.9 DTI [A]	1,9	60	F9Q-77... <EEC99/102A>	10.01-10.05	DBJ	4	0 445 110 021	0 986 435 007	
2.2 DTI [A]	2,2	66	G9T-7... <ECC99/102A>	03.01-10.05	DBJ	4	0 445 110 102	0 986 435 106	
			G9T-720 <EEC96/69>	09.00-10.05	DBJ	4	0 445 110 063	0 986 435 075	
2.5 DTI [A]	2,5	73-74	G9U-754 <ECC99/102A>	10.01-03.10	DBJ	4	0 445 110 141	0 986 435 086	
			84	G9U-7... <ECC99/102A>	10.01-10.07	DBJ	4	0 445 110 141	0 986 435 086
		88/107	G9U-632; G9U-650	08.06-03.10	DBB	4	0 445 110 087	0 986 435 079	
<b>Vivaro</b>									
1.9 CDTI, DTI	1,9	60/74	F9Q-760; F9Q-762	03.01-08.06	DBJ	4	0 445 110 021	0 986 435 007	
2.0 CDTI	2,0	66/84	M9R-78...	08.06→	DBB	4	0 445 115 007	0 986 435 350	
2.5 CDTI	2,5	84/107	G9U-630 <Turbo-ecotec>; G9U-630, G9MB6 <Turbo>	08.06→	DBB	4	0 445 110 265	0 986 435 170	
			99	G9U-730 <Turbo>	09.02-08.06	DBJ	4	0 445 110 087	0 986 435 079

**PAZ PAVLOVO**

<b>Serie 3000</b>									
3237	3,9	110	ISBe 150.30 <Euro 3>	01.00→	DBJ	4	0 445 120 212	0 986 435 508	
			-03, -09	4,5	117,7/136	4ISBe 160B <Euro 3>; 4ISBe 185B <Euro 3>	06.09→	DBJ	4
<b>Serie 4000</b>									
4230	4,5	136	4ISBe 185B <Euro 3>	06.09→	DBJ	4	0 445 120 123		
4234	4,8	100	D 245.9 E4 <Euro 4>	12.11→	DBJ	4	0 445 120 245		
			D 245.9 E3 <Euro 3>	01.08→	DBJ	4	0 445 120 141		
<b>Serie 32000</b>									
32053	4,8	100	D 245.9 E4 <Euro 2>	12.11→	DBJ	4	0 445 120 245		
			D 245.9 E3 <Euro 3>	01.08→	DBJ	4	0 445 120 141		
<b>Serie 320000</b>									
320301-03	4,5	136	4ISBe 185B <Euro 3>	06.09→	DBJ	4	0 445 120 123		

**PEUGEOT**

<b>Boxer</b>									
2.0 HDi [U3]	2,0	62	RHV <DW10TD>	09.01-02.02	DBB	4	0 445 110 076	0 986 435 077	
			HDi [U5]	02.02-05.06	DBB	4	0 445 110 076	0 986 435 077	
2.2 HDi [U5]	2,2	74	4HY <DW12TED>	02.02-05.06	DBB	4	0 445 110 076	0 986 435 077	
2.8 HDi [U3]	2,8	94	8140 43s <SOFIM 2800 HDi>	09.00-02.02	DBJ	4	0 445 120 002	0 986 435 501	
			8140 43N <SOFIM 2800 HDi>; 8140 43s <SOFIM 2800 HDi>	02.02-05.06	DBJ	4	0 445 120 002	0 986 435 501	
HDI	2,8	93	8140 43s	09.05-09.09	DBJ	4	0 445 120 002	0 986 435 501	

**RENAULT**

<b>Kerax</b>									
270	11,1	195	dCI 11 I <Euro 3>	01.01-04.06	DBJ	6	0 445 120 014	0 986 435 515	
320	11,1	230	dCI 11 G <Euro 3>	01.01-04.06	DBJ	6	0 445 120 014	0 986 435 515	
370	11,1	266	dCI 11 E <Euro 3>						
			Mot. Typ Variante 14102→	11.01-04.06	DBJ	6	0 445 120 019	0 986 435 523	
420	11,1	303	dCI 11 C <Euro 3>	01.01-04.06	DBJ	6	0 445 120 019	0 986 435 523	
<b>Mascott</b>									
110	2,8	78	8140.43B.3586/3588	01.01-06.04	DBJ	4	0 445 120 002	0 986 435 501	
130	2,8	92	8140.43S.2585; 8140.43S.3585	01.99-06.04	DBJ	4	0 445 120 002	0 986 435 501	
140	2,8	103	8140.43K.2585	01.01-06.04	DBJ	4	0 445 120 002	0 986 435 501	
150	2,8	107	8140.43N.3585	10.01-06.04	DBJ	4	0 445 120 002	0 986 435 501	
160	3,0	115	DXi 3-160 ZD3 604	05.04-05.07	DBJ	4	0 445 110 169		





◀ RENAULT

Master									
1.9 dCi 80 [X70]	1,9	60	F9Q 772	05.00-03.03	DBJ	4	0 445 110 146	0 986 435 007	
			F9Q 774	10.03-10.06	DBB	4	0 445 110 110	0 986 435 080	
2.2 dCi 90 [X70]	2,2	66	G9T 720	01.00-09.03	DBJ	4	0 445 110 063	0 986 435 075	
			G9T 722	05.00-09.03	DBJ	4	0 445 110 102	0 986 435 106	
			G9T 750	10.03-10.06	DBJ	4	0 445 110 102	0 986 435 106	
2.5 dCi 16V [ADCU]	2,5	85	G9U-724	10.04-→	DBJ	4	0 445 110 141	0 986 435 086	
dCi 90 [X70]	2,5	84	G9U 720	05.00-09.03	DBJ	4	0 445 110 087	0 986 435 079	
dCi 100, dCi 110, dCi 120 [X70]	2,5	73/81/84	G9U 754	10.03-10.06	DBJ	4	0 445 110 141	0 986 435 086	
dCi 100, dCi 120, dCi 120 FAP, dCi 150 FAP	2,5	74/88/107	G9U 632 (MY) <Euro 4>; G9U 632 (M1) <120BQ, Euro 4>; G9U 650 (M1) <120B0, Euro 4>; G9U 650 (M2) <120BN, Euro 4>	11.06-04.10	DBB	4	0 445 110 265	0 986 435 170	
dCi 120 [X70]	2,5	84	G9U 724	07.02-09.03	DBJ	4	0 445 110 141	0 986 435 086	
			G9U 750	10.03-10.06	DBJ	4	0 445 110 087	0 986 435 079	
Midlum									
150	4,0	112	dCi 4B <Euro 3>	07.01-04.06	DBJ	4	0 445 120 016	0 986 435 531	
180	4,0	128	dCi 4C <Euro 3>	07.01-04.06	DBJ	4	0 445 120 016	0 986 435 531	
220 4x2, 4x4	6,2	158/162	dCi 6W <Euro 3>	07.01-04.06	DBJ	6	0 445 120 012	0 986 435 525	
270	6,2	195	dCi 6A <Euro 3>	07.01-04.06	DBJ	6	0 445 120 012	0 986 435 525	
Midlum II									
160	4,8	118	DXi 5 160 <Euro 3/4>	05.06-03.09	DBJ,EU3	4	0 445 120 074		
					DBJ,EU4	4	0 445 120 064	0 986 435 529	
180	4,8	132	DXi 5 180 <Euro 5>	04.09-→	DBJ,TW	4	0 445 120 064	0 986 435 529	
						4	0 445 120 074		
190	4,8	140	DXi 5 190 <Euro 3/4>	05.06-03.09	DBJ,EU3	4	0 445 120 074		
					DBJ,EU4	4	0 445 120 064	0 986 435 529	
220	4,8	158	DXi 5 220 <Euro 3/4>	05.06-03.09	DBJ,EU3	4	0 445 120 074		
					DBJ,EU4	4	0 445 120 064	0 986 435 529	
			DXi 5 220 <Euro 5>	03.07-03.09	DBJ,EU3	4	0 445 120 074		
					DBJ,EU4	4	0 445 120 064	0 986 435 529	
		162	DXi 5 220 <Euro 5>	04.09-→	DBJ,TW	4	0 445 120 064	0 986 435 529	
						4	0 445 120 074		
240	7,2	177	DXi 7 240 <Euro 3/4>	05.06-03.09	DBJ,EU3	6	0 445 120 074		
					DBJ,EU4	6	0 445 120 064	0 986 435 529	
270	7,2	199	DXi 7 270 <Euro 5>	04.09-→	DBJ,TW	4	0 445 120 064	0 986 435 529	
						4	0 445 120 074		
280	7,2	206	DXi 7 280 <Euro 3/4>; DXi 7 280 <Euro 5>	05.06-03.09	DBJ,EU3	6	0 445 120 074		
					DBJ,EU4	6	0 445 120 064	0 986 435 529	
300	7,2	221	DXi 7 300 <Euro 5>	04.09-→	DBJ,TW	6	0 445 120 064	0 986 435 529	
						6	0 445 120 074		
Premium									
220 Distribution	6,2	158	dCi 6 W <Euro 3>	11.00-04.06	DBJ	6	0 445 120 012	0 986 435 525	
270 Distribution, Lander	6,2	195	dCi 6 A <Euro 3>	11.00-04.06	DBJ	6	0 445 120 012	0 986 435 525	
320 Distribution, Lander, Route	11,1	229	dCi 11 G <Euro 3>	01.00-04.06	DBJ	6	0 445 120 014	0 986 435 515	
370 Distribution, Lander, Route	11,1	266	dCi 11 E <Euro 3>						
			Mot. Typ Variante 14102-→	11.01-04.06	DBJ	6	0 445 120 019	0 986 435 523	
420 Distribution, Lander, Route	11,1	303	dCi 11 C <Euro 5>	11.00-04.06	DBJ	6	0 445 120 019	0 986 435 523	
Route	11,1	303	dCi 06.23.56 B43 <Euro 3>	01.00-09.01	DBJ	6	0 445 120 003	0 986 435 524	
Premium II									
240 Distribution	7,2	177	DXi 7 240 <122CX, Euro 4>	06.06-03.09	DBJ	6	0 445 120 064	0 986 435 529	
270 Distribution, Lander	7,2	199	DXi 7 270 <Euro 5>	04.09-→	DBJ	6	0 445 120 064	0 986 435 529	
280 Distribution	7,2	206	DXi 7 280 <122CW, Euro 4>	06.06-03.09	DBJ	6	0 445 120 064	0 986 435 529	
Distribution, Lander	7,2	206	DXi 7 280 <Euro 5>	03.07-03.09	DBJ	6	0 445 120 064	0 986 435 529	
Lander	7,2	206	DXi 7 280 <122CW, Euro 4>	03.07-03.09	DBJ	6	0 445 120 074		
310 Distribution, Lander	7,2	228	DXi 7 310 <Euro 5>	04.09-→	DBJ	6	0 445 120 064	0 986 435 529	
320 Distribution	7,2	235	DXi 7 320 <122CY, Euro 4>	05.06-03.09	DBJ	6	0 445 120 064	0 986 435 529	
Distribution, Lander	7,2	235	DXi 7 320 <Euro 5>	03.07-03.09	DBJ	6	0 445 120 064	0 986 435 529	
Lander	7,2	235	DXi 7 320 <122CY, Euro 4>	03.07-03.09	DBJ	6	0 445 120 074		
340 Distribution, Lander	7,2	250	DXi 7 340 <Euro 5>	04.09-→	DBJ	6	0 445 120 064	0 986 435 529	





l/ccm



kW/(PS)



Typ



Zyl.

**Trafic**

1.9 DCI [EL./FL./JL.]	1,9	60/74	F9Q 760; F9Q 762	05.01-12.06	DBJ	4	0 445 110 146	0 986 435 007
2.0 DCI [EL./FL./JL.]	2,0	66/85	M9R 780; M9R 782	01.06→	DBB	4	0 445 115 007	0 986 435 350
2.5 DCI [EL./FL./JL.]	2,5	98	G9U 730	06.02-12.06	DBJ	4	0 445 110 087	0 986 435 079
		107	G9U 630	01.06→	DBB	4	0 445 110 265	0 986 435 170

**TEMSA****Opalin**

8	4,6	152	D0834 LFL51/52 <Euro 4>	09.05→	DBJ	4	0 445 120 147	
9	6,9	176	D0836 LOH52 <Euro 4>	09.05→	DBJ	6	0 445 120 147	

**TONAR****24t**

5422	11,1	303	650.10 <Euro 3>	01.10→	DBJ	6	0 445 120 142	
6428	11,1	303	650.10 <Euro 3>	01.10→	DBJ	6	0 445 120 142	
6528	11,1	303	650.10 <Euro 3>	01.10→	DBJ	6	0 445 120 142	

**URAL AUTOMOBIL PLANT****18t**

6367 -31	11,1	266	6501.10 <Euro 3>	12.09→	DBJ	6	0 445 120 142	
----------	------	-----	------------------	--------	-----	---	---------------	--

**29t**

6470	11,1	303	650 DCi 11 <Euro 3>	01.08→	DBJ	6	0 445 120 142	
------	------	-----	---------------------	--------	-----	---	---------------	--

**33t**

63621	11,1	303	650.10 <Euro 3>	01.08→	DBJ	6	0 445 120 142	
-------	------	-----	-----------------	--------	-----	---	---------------	--

65685	11,1	303	650 DCi 11 <Euro 3>	01.08→	DBJ	6	0 445 120 142	
-------	------	-----	---------------------	--------	-----	---	---------------	--

**41t**

6563	11,1	303	650 DCi 11 <Euro 3>	01.08→	DBJ	6	0 445 120 142	
------	------	-----	---------------------	--------	-----	---	---------------	--

**VAUXHALL****Movano**

1.9 DTI [A]	1,9	60	F9Q-772	10.01-10.05	DBJ	4	0 445 110 021	0 986 435 007
			F9Q-774	10.01-10.05	DBJ,TW	4	0 445 110 021	0 986 435 007

2.2 DTI [A]	2,2	66	G9T-720	01.01-10.05	DBJ	4	0 445 110 063	0 986 435 075
-------------	-----	----	---------	-------------	-----	---	---------------	---------------

			G9T-722; G9T-750	03.02-10.05	DBJ	4	0 445 110 102	0 986 435 106
--	--	--	------------------	-------------	-----	---	---------------	---------------

2.5 DTI [A]	2,5	74-84	G9U-75... <Turbo>; G9U-724	10.03-03.10	DBJ	4	0 445 110 141	0 986 435 086
-------------	-----	-------	----------------------------	-------------	-----	---	---------------	---------------

		74-88/ 107	G9U-6... <Turbo>; G9U-632 <Turbo>	08.06-03.10	DBB	4	0 445 110 265	0 986 435 170
--	--	---------------	-----------------------------------	-------------	-----	---	---------------	---------------

		84	G9U-7... <Turbo>	10.01-03.07	DBJ	4	0 445 110 141	0 986 435 086
--	--	----	------------------	-------------	-----	---	---------------	---------------

					DBJ,TW	4	0 445 110 087	0 986 435 079
--	--	--	--	--	--------	---	---------------	---------------

**Vivaro**

1.9 DI, DTI	1,9	59-60/74	F9Q-760; F9Q-762	03.01-08.06	DBJ	4	0 445 110 021	0 986 435 007
-------------	-----	----------	------------------	-------------	-----	---	---------------	---------------

2.0 CDTI	2,0	66/84	M9R-78...; M9R-780	08.06→	DBB	4	0 445 115 007	0 986 435 350
----------	-----	-------	--------------------	--------	-----	---	---------------	---------------

2.5 CDTI	2,5	84/107	G9U-630 <Turbo>; G9U-630 <Turbo-Ecotec>	08.06→	DBB	4	0 445 110 265	0 986 435 170
----------	-----	--------	---	--------	-----	---	---------------	---------------

DTI	2,5	99	G9U-730 <Turbo>	04.04-08.06	DBJ	4	0 445 110 087	0 986 435 079
-----	-----	----	-----------------	-------------	-----	---	---------------	---------------

**VOLVO****FE**

240	7,1	177	D7E240	05.06→	DBJ,EU4	6	0 445 120 064	0 986 435 529
-----	-----	-----	--------	--------	---------	---	---------------	---------------

			D7F240	05.09→	DBJ	6	0 445 120 064	0 986 435 529
--	--	--	--------	--------	-----	---	---------------	---------------

260	7,1	191	D7F260	05.09→	DBJ	6	0 445 120 064	0 986 435 529
-----	-----	-----	--------	--------	-----	---	---------------	---------------

280	7,1	206	D7E280	05.06→	DBJ,EU4	6	0 445 120 064	0 986 435 529
-----	-----	-----	--------	--------	---------	---	---------------	---------------

300	7,1	221	D7F300	05.09→	DBJ	6	0 445 120 064	0 986 435 529
-----	-----	-----	--------	--------	-----	---	---------------	---------------

320	7,1	235	D7E320	05.06→	DBJ,EU4	6	0 445 120 064	0 986 435 529
-----	-----	-----	--------	--------	---------	---	---------------	---------------

340	7,1	250	D7F340	05.09→	DBJ	6	0 445 120 064	0 986 435 529
-----	-----	-----	--------	--------	-----	---	---------------	---------------





◀ VOLVO

FL									
240	7,1	177	D7E240	05.06→	DBJ,EU4	6	0 445 120 064	0 986 435 529	
			D7F240	04.09→	DBJ	6	0 445 120 064	0 986 435 529	
260	7,1	191	D7F260	04.09→	DBJ	6	0 445 120 064	0 986 435 529	
280	7,1	206	D7E280	05.06→	DBJ,EU4	6	0 445 120 064	0 986 435 529	
290	7,1	213	D7F290	04.09→	DBJ	6	0 445 120 064	0 986 435 529	
320	7,1	236	D7E320	05.06→	DBJ,EU4	6	0 445 120 064	0 986 435 529	

**VW (VOLKSWAGEN)**

California T5									
2.0 TDI, TDI 4 Motion [7E]	2,0	62/75/84/100/103/132	CAAA <D54>; CAAB <D55>; CAAC <D94>; CAAD <DK3>; CAAE <D94>; CCHA <D91>; CCHB <D94>; CFCA <D49>	09.09→	DBJ	4	0 445 116 034	0 986 435 369	

Caravelle T5									
2.0 TDI, TDI 4 Motion [7E]	2,0	62/75/84/100/103/132	CAAA <D54>; CAAB <D55>; CAAC <D94>; CAAD <DK3>; CAAE <D94>; CCHA <D91>; CCHB <D94>; CFCA <D49>	09.09→	DBJ	4	0 445 116 034	0 986 435 369	

Crafter 30									
2.5 TDI [2E, 2F]	2,5	65/80/100/120	BJJ <D5K>; BJK <D5L>; BJL <D5M>; BJM <D5N>; CEBA <D5K>; CEBB <D5L>; CECA <D5M>; CECB <D5N>	04.06→	DBJ	5	0 445 115 028	0 986 435 352	

Crafter 35									
2.5 TDI [2E, 2F]	2,5	65/80/100/120	BJJ <D5K>; BJK <D5L>; BJL <D5M>; BJM <D5N>; CEBA <D5K>; CEBB <D5L>; CECA <D5M>; CECB <D5N>	04.06→	DBJ	5	0 445 115 028	0 986 435 352	

Crafter 50									
2.5 TDI [2E, 2F]	2,5	80/100/120	BJK <D5L>; BJL <D5M>; BJM <D5N>; CEBB <D5L>; CECA <D5M>; CECB <D5N>	04.06→	DBJ	5	0 445 115 028	0 986 435 352	

LT									
28 2.8 TDI [2D, 2H]	2,8	116	AUH	02.02-04.06	DBB	4	0 445 110 081		
			BCQ	06.03-04.06	DBJ	4	0 445 110 125		
35 2.8 TDI [2D, 2H]	2,8	116	AUH	02.02-04.06	DBB	4	0 445 110 081		
			BCQ	06.03-04.06	DBJ	4	0 445 110 125		
46 2.8 TDI [2D, 2H]	2,8	116	AUH	02.02-04.06	DBB	4	0 445 110 081		

Multivan T5									
2.0 TDI, TDI 4 Motion [7E]	2,0	62/75/84/100/103/132	CAAA <D54>; CAAB <D55>; CAAC <D94>; CAAD <DK3>; CAAE <D94>; CCHA <D91>; CCHB <D94>; CFCA <D49>	09.09→	DBJ	4	0 445 116 034	0 986 435 369	

Transporter T5									
2.0 TDI, TDI 4 Motion [7E]	2,0	62/75/84/100/103/132	CAAA <D54>; CAAB <D55>; CAAC <D94>; CAAD <DK3>; CAAE <D94>; CCHA <D91>; CCHB <D94>; CFCA <D49>	09.09→	DBJ	4	0 445 116 034	0 986 435 369	
TDI, TDI 4 Motion [7F]	2,0	62/75/84/100/103/132	CAAA <D54>; CAAB <D55>; CAAC <D94>; CAAD <DK3>; CAAE <D94>; CCHA <D91>; CCHB <D94>; CFCA <D49>	09.09→	DBJ	4	0 445 116 034	0 986 435 369	

**ZIL**

Serie 7t									
5301EE	4,8	100	D 245.9 E3 <Euro 3>	01.08→	DBJ	4	0 445 120 141		
Serie 14t									
433185	7,1	169	D 260.5 E3 <Euro 3>	05.08→	DBJ	6	0 445 120 141		
Serie 15t									
4334B1	4,8	115	D 245.30 E3 <Euro 3>	05.08→	DBJ	4	0 445 120 141		





**MTZ (MINSK TRAKTOR WERK)**

<b>Belarus</b>									
1025	4,8	105	D 245 E3 <Euro 3>		01.08→	DBJ	4	0 445 120 141	



**KAMAZ****Serie 740**

<b>740.60</b> -360	11,8	265	740.72-360 <Euro 4>	08.08→	DBJ	8	<b>0 445 120 153</b>
<b>740.61</b> -320	11,8	236	740.71-320 <Euro 4>	08.08→	DBJ	8	<b>0 445 120 153</b>
<b>740.62</b> -280	11,8	206	740.70-280 <Euro 4>	08.08→	DBJ	8	<b>0 445 120 153</b>
<b>740.63</b> -400	11,8	294	740.73-400 <Euro 4>	08.08→	DBJ	8	<b>0 445 120 153</b>
<b>740.64</b> -420	11,8	309	740.74-420 <Euro 4>	08.08→	DBJ	8	<b>0 445 120 153</b>
<b>740.65</b> -240	11,8	324	740.75-440 <Euro 4>	08.08→	DBJ	8	<b>0 445 120 153</b>

**MMZ (MINSK MOTOREN WERK)****Serie D**

<b>245</b> .30 E3, .35 E3, .7 E3, .9 E3	4,8	90/100/ 115/125	D 245.30 E3 <Euro 3>; D 245.35 E3 <Euro 3>; D 245.7 E3 <Euro 3>;	01.08→	<del>DBJ</del>	4	<b>0 445 120 141</b>
<b>249</b>	4,8	140	D 249 <Euro 3>	10.07→	<del>DBJ</del>	4	<b>0 445 120 141</b>
<b>260</b> E3	7,1	169	D 260 E3 <Euro 3>	01.08→	<del>DBJ</del>	6	<b>0 445 120 141</b>
<b>262</b> S2	7,9	220,5	D 262 S2 <Euro 3>	10.07→	<del>DBJ</del>	6	<b>0 445 120 141</b>
<b>263</b> .1 E3	8,7	257,4	D 263.1 E3 <Euro 3>	10.07→	<del>DBJ</del>	6	<b>0 445 120 141</b>

**YAMZ (YAROSLAWL MOTORENWERKE)****Serie 650**

<b>650</b> .10	11,1	303	650.10 <Euro 3>	11.08→	<del>DBJ</del>	6	<b>0 445 120 142</b>
<b>6501</b> .10	11,1	266	6501.10 <Euro 3>	11.08→	<del>DBJ</del>	6	<b>0 445 120 142</b>
<b>6502</b> .10	11,1	230	6502.10 <Euro 3>	11.08→	<del>DBJ</del>	6	<b>0 445 120 142</b>





## ALFA ROMEO

ALFA ROMEO							
<b>Brera</b>							
2.0 JTDM [939]	2,0	125	939B3000 <M120>		05.09→	0 445 010 302	0 986 437 046
2.4 JTDM 20V [939]	2,4	147	939A3000 <M95>		04.06→	0 445 010 123	
		154	939A9000 <M105>		05.07→	0 445 010 166	
<b>GT</b>							
1.9 JTD 16V [937]	1,9	110	937A5000 <M15>		10.03→	0 445 010 071	
			937A5000 <M92>		01.04-01.06	0 445 010 166	
					02.06→	0 445 010 302	0 986 437 046
		125	937A6000 <M94>		10.07→	0 445 010 302	0 986 437 046
<b>Mito</b>							
1.3 JTD [145]	1,3	66	199A3000 <M72>		10.08→	0 445 010 293	0 986 437 036
		70	199B1000 <M95>		10.08→	0 445 010 292	
1.6 JTD [145]	1,6	84	955A4000 <M87>		09.08→	0 445 010 302	0 986 437 046
		88	955A3000 <M88>		08.08→	0 445 010 302	0 986 437 046
<b>Spider</b>							
2.0 JTDM [939]	2,0	125	939B3000 <M120>		05.09-12.10	0 445 010 302	0 986 437 046
2.4 JTDM 20V [939]	2,4	147/154	939A3000 <M95>; 939A3000 <M105>		03.07-12.10	0 445 010 123	
<b>145</b>							
1.9 JTD [930 MY97]	1,9	76	AR 32302 <M20>		05.98-02.99	0 445 010 007	0 986 437 002
JTD [930 MY99]	1,9	76	AR 32302 <M20>		02.99-12.00	0 445 010 007	0 986 437 002
<b>146</b>							
1.9 JTD [930 MY97]	1,9	76	AR 32302 <M13>		05.98-02.99	0 445 010 007	0 986 437 002
JTD [930 MY99]	1,9	76	AR 32302 <W4 M20>		02.99-12.00	0 445 010 007	0 986 437 002
<b>147</b>							
1.9 JTD [937]	1,9	74	182B9000 <M14>		06.03-10.06	0 445 010 007	0 986 437 002
		81-85	937A2000 <M15>		11.00-03.05	0 445 010 007	0 986 437 002
JTDM [937]	1,9	85	939A7000 <M87>		01.06-12.10	0 445 010 166	
		88	937A3000 <M88>		02.06-12.10	0 445 010 166	
JTDM 16V [937]	1,9	93/103	192A5000 <M17>; 937A4000 <M16>		10.02-09.06	0 445 010 071	
		100	192B1000 <M91>		02.06-03.07	0 445 010 166	
				04.07-12.10	0 445 010 302	0 986 437 046	
		100/110	192B1000 <M18>; 937A5000 <M19>		02.04-12.05	0 445 010 071	
		110	937A5000 <M92>		02.06-03.07	0 445 010 166	
				04.07-12.10	0 445 010 302	0 986 437 046	
		125	937A6000 <M94>		10.07-12.10	0 445 010 302	0 986 437 046
<b>156 Berlina</b>							
1.9 JTD [932]	1,9	74	182B9.000 <M24>		06.03-12.04	0 445 010 007	0 986 437 002
		76/81-85	AR32302 <M1>; AR37101 / 937A2.000 <M3/M5>; 937A2.000 <M25>		10.97-10.05	0 445 010 007	0 986 437 002
JTD 16V [932]	1,9	93/100	192B1000 <M29>; 937A4.000 <M26>		06.03-10.05	0 445 010 071	
		103	192A5.000 <M27>		10.02-10.05	0 445 010 071	
2.4 JTD [932]	2,4	100/110	AR32501 <M2>; 839A6.000 <M4>; 841C000 <M30>		10.97-10.05	0 445 010 006	0 986 437 001
JTD, JTD 20V [932]	2,4	120/129	841G.000 <M31>; 841M000 <M33>		06.03-10.05	0 445 010 072	
<b>156 Cross Wagon Q4</b>							
1.9 JTD 4x4 [932]	1,9	110	937A5000 <M28 / M92>		10.04-12.05 EU3	0 445 010 071	
<b>156 Sport Wagon</b>							
1.9 JTD [932]	1,9	74	182B9.000 <M24>		06.03-12.04	0 445 010 007	0 986 437 002
		76/80-85	AR32302 CF2 <M1>; AR37101 / 937A2.000 <M3/M5 CF3>; 937A2.000 <M25>		06.00-12.05	0 445 010 007	0 986 437 002
JTD 16V [932]	1,9	93	937A4.000 <M26/M90>		06.03-10.05	0 445 010 071	
		93/110	937A4000 <M90>; 937A5000 <M82 E4>		10.03-12.05	0 445 010 166	
		100	192B1000 <M29>		10.04-10.05	0 445 010 071	
		103	192A5.000 <M27>		10.02-12.05	0 445 010 071	
2.4 JTD [932]	2,4	100/110	AR32501 CF2 <M2>; 839A6.000 CF3 <M4>; 841C000 <M30>		06.00-10.05	0 445 010 006	0 986 437 001
JTD, JTD 20V [932]	2,4	120/129	841G000 <M31>; 841M000 <M33>		06.03-12.05	0 445 010 072	
<b>156 Sport Wagon Q4</b>							
1.9 JTD 16V 4x4 [932]	1,9	110	937A5000 <M28 / M92>		10.04-12.05 EU3	0 445 010 071	
<b>159</b>							
2.0 JTDM 16V [939..]	2,0	100			06.10→	0 445 010 302	0 986 437 046



A



◀ ALFA ROMEO

159 Berlina							
1.9	JTDM 16V [939]	1,9	100/110	937A8000 <M91>; 939A2000 <M92 E4>	06.05-12.08	0 445 010 302	0 986 437 046
2.0	JTDM 16V [939]	2,0	125	939B3000 <M120>	05.09-12.10	0 445 010 302	0 986 437 046
2.4	JTD 20V [939]	2,4	154	939A9000 <M105>	02.07-12.08	0 445 010 166	
	JTDM 20V [939]	2,4	147	939A3000 <M95 E4>	06.05-12.08	0 445 010 123	
159 Berlina Q4							
2.4	JTD 20V [939]	2,4	154	939A9000 <M110>	09.06-12.08	0 445 010 166	
159 Sport Wagon							
1.9	JTDM 16V [939]	1,9	100/110	937A8000 <M91>; 939A2000 <M92 E4>	03.06-12.08	0 445 010 166	
2.0	JTDM 16V [939..]	2,0	100		06.10→	0 445 010 302	0 986 437 046
	JTDM 16V [939]	2,0	125	939B3000 <M120>	05.09-12.10	0 445 010 302	0 986 437 046
2.4	JTD 20V [939]	2,4	154	939A9000 <M105>	02.07-12.08	0 445 010 166	
	JTDM 20V [939]	2,4	147	939A3000 <M95 E4>	03.06-12.08	0 445 010 123	
159 Sport Wagon Q4							
2.4	JTD 20V [939]	2,4	154	939A9000 <M110>	09.06-12.08	0 445 010 166	
166							
2.4	JTD [936]	2,4	100-110	AR 34202 <M20>; 839A6000 / 841C000 <M21/M22>	10.98-10.07	0 445 010 006	0 986 437 001
	JTD 20V [936]	2,4	120/128/129	841G000 / 841H000 <M25/M26>; 841M000 <M27>; 841N000 <M28>	06.03-10.07	0 445 010 072	
	JTDM 20V [936]	2,4	132-136	936B000 <M99>	10.05-10.07	0 445 010 123	

**AUDI**

A1							
2.0	TDI [8X1]	2,0	100/105	CFHB <D92>; CFHD <D92>	09.11→	0 445 010 551	0 986 437 412
A1 Sportback							
2.0	TDI [8XA]	2,0	100/105	CFHB <D92>; CFHD <D92>	09.11→	0 445 010 551	0 986 437 412
A3							
2.0	TDI [8P1]	2,0	100	CFFA <D94>	11.09-01.10	0 445 010 551	0 986 437 412
					02.10-08.10	0 445 010 557	0 986 437 420
					09.10→	0 445 010 566	0 986 437 420
		103		CLJA <D91>	02.10-08.10	0 445 010 557	0 986 437 420
					09.10→	0 445 010 566	0 986 437 420
	TDI, TDI quattro [8P1]	2,0	100/103/125	CBAA; CBAB; CBAB <D91>; CBBB <D93>	07.08-05.10	0 445 010 546	0 986 437 408
			103	CFFB <D91>	11.09-01.10	0 445 010 551	0 986 437 412
					02.10-08.10	0 445 010 557	0 986 437 420
					09.10→	0 445 010 566	0 986 437 420
			125	CFGB <D93>	11.09-01.10	0 445 010 551	0 986 437 412
					02.10-08.10	0 445 010 557	0 986 437 420
					09.10→	0 445 010 566	0 986 437 420
A3 Cabriolet							
2.0	TDI [8P7]	2,0	100	CFFA	11.09-01.10	0 445 010 551	0 986 437 412
					02.10-08.10	0 445 010 557	0 986 437 420
					09.10→	0 445 010 566	0 986 437 420
			100/103	CBAA <D94>; CBAB <D91>	04.08-05.10	0 445 010 546	0 986 437 408
			103	CFFB	11.09-01.10	0 445 010 551	0 986 437 412
A3 Sportback							
2.0	TDI [8PA]	2,0	100	CFFA <D94>	11.09-01.10	0 445 010 551	0 986 437 412
					02.10-08.10	0 445 010 557	0 986 437 420
					09.10→	0 445 010 566	0 986 437 420
			103	CLJA <D91>	02.10-08.10	0 445 010 557	0 986 437 420
					09.10→	0 445 010 566	0 986 437 420
	TDI, TDI quattro [8PA]	2,0	100/103/125	CBAA <D94>; CBAB <D91>; CBBB <D93>	07.08-05.10	0 445 010 546	0 986 437 408
			103	CFFB <D91>	11.09-01.10	0 445 010 551	0 986 437 412
					02.10-08.10	0 445 010 557	0 986 437 420
					09.10→	0 445 010 566	0 986 437 420
			125	CFGB <D93>	11.09-01.10	0 445 010 551	0 986 437 412
					02.10-08.10	0 445 010 557	0 986 437 420
					09.10→	0 445 010 566	0 986 437 420















<b>A4</b>								
2.0 TDI [8K2; B8]	2,0	100	CJCB <D94>	11.10→	0 445 010 551	0 986 437 412		
		105	CMEA <D92>	05.10→	0 445 010 543	0 986 437 410		
TDI, TDI quattro [8K2; B8]	2,0	88/100/ 105/120/ 125	CAGA <D92>; CAGB <D94>; CAGC <D90>; CAHA <D93>; CAHB <D95>	11.07→	0 445 010 546	0 986 437 408		
2.7 TDI [8EC; B7]	2,7	120	BSG					
			Fg.Nr. →8E..6..184 000 →8E..6..800 880	11.05-02.06	0 445 010 343	0 986 437 348		
		Fg.Nr. 8E..6..184 001→8E..6..800 881→	03.06-06.08	0 445 010 331	0 986 437 093			
		132	BPP					
			Fg.Nr. →8E..6..184 000 →8E..6..800 880	11.05-02.06	0 445 010 343	0 986 437 348		
			Fg.Nr. 8E..6..184 001→8E..6..800 881→	03.06-06.08	0 445 010 331	0 986 437 093		
TDI [8K2; B8]	2,7	120/140	CAMA <D4V>; CAMB <D4V>; CGKA <D4V>; CGKB	11.07→	0 445 010 659			
3.0 TDI quattro [8EC; B7]	3,0	150	BKN					
			Fg.Nr. →8E..6..184 000 →8E..6..800 880	01.05-12.05	0 445 010 343	0 986 437 348		
		Fg.Nr. 8E..6..184 001→8E..6..800 881→	01.06-05.06	0 445 010 331	0 986 437 093			
		171	ASB	01.06-06.08	0 445 010 331	0 986 437 093		
		TDI quattro [8K2; B8]	3,0	155/176	CCWA <D50>; CCWB <D1V>	06.08→	0 445 010 659	
		176	CAPA					
			Fg.Nr. →8K..8A040 000 →8K..8M015 000	11.07-03.08	0 445 010 331	0 986 437 093		
			Fg.Nr. 8K..8A040 001→8K..8N015 001→	04.08-05.08	0 445 010 659			
			CCLA	11.09-03.10	0 445 010 654			
<b>A4 Avant</b>								
2.0 TDI [8K5; B8]	2,0	100	CJCB <D94>	11.10→	0 445 010 551	0 986 437 412		
		105	CMEA <D92>	05.10→	0 445 010 543	0 986 437 410		
TDI, TDI quattro [8K5; B8]	2,0	88/100/ 105/120/ 125	CAGA <D92>; CAGB <D94>; CAGC <D90>; CAHA <D93>; CAHB <D95>	04.08→	0 445 010 546	0 986 437 408		
2.7 TDI [8ED; B7]	2,7	120	BSG					
			Fg.Nr. →8E..6..184 000 →8E..6..800 880	11.05-02.06	0 445 010 343	0 986 437 348		
		Fg.Nr. 8E..6..184 001→8E..6..800 881→	03.06-06.08	0 445 010 331	0 986 437 093			
		132	BPP					
			Fg.Nr. →8E..6..184 000 →8E..6..800 880	11.05-02.06	0 445 010 343	0 986 437 348		
			Fg.Nr. 8E..6..184 001→8E..6..800 881→	03.06-06.08	0 445 010 331	0 986 437 093		
TDI [8K5; B8]	2,7	120/140	CAMA <D4V>; CAMB <D4V>; CGKA; CGKB	04.08→	0 445 010 659			
3.0 TDI quattro [8ED; B7]	3,0	150	BKN					
			Fg.Nr. →8E..6..184 000 →8E..6..800 880	01.05-12.05	0 445 010 343	0 986 437 348		
		Fg.Nr. 8E..6..184 001→8E..6..800 881→	01.06-05.06	0 445 010 331	0 986 437 093			
		171	ASB	01.06-06.08	0 445 010 331	0 986 437 093		
		TDI quattro [8K5; B8]	3,0	155/176	CAPA <D50>; CCWA <D50>; CCWB <D1V>	04.08→	0 445 010 659	
		176	CCLA	11.09-03.10	0 445 010 654			
<b>A4 Avant Allroad</b>								
2.0 TDI [8KH]	2,0	100/105/ 120/125	CAGA <D92>; CAGB <D94>; CAHA <D93>; CAHB <D95>	04.09→	0 445 010 546	0 986 437 408		
3.0 TDI [8KH]	3,0	176	CCWA <D50>	04.09-10.10	0 445 010 659			
				11.10→	0 445 010 669	0 986 437 404		
<b>A4 Cabriolet</b>								
2.7 TDI [8HE; B7]	2,7	132	BPP	11.05-03.09	0 445 010 331	0 986 437 093		
3.0 TDI quattro [8HE; B7]	3,0	150/171	ASB; BKN	01.06-03.09	0 445 010 331	0 986 437 093		
<b>A5 Cabriolet</b>								
2.0 TDI [8F7]	2,0	120/125	CAHA <D93>; CAHB <D95>	05.09→	0 445 010 546	0 986 437 408		
2.7 TDI [8F7]	2,7	120/140	CGKA <D4V>; CGKB <D1W>	03.09→	0 445 010 659			
3.0 TDI [8F7]	3,0	150	CLAB <D1Q>	09.11→	0 445 010 658			
			TDI quattro [8F7]	3,0	176	CCWA <D50>	03.09→	0 445 010 659
		180	CDUC <D43>	10.11→	0 445 010 657			
<b>A5 Coupé</b>								
2.0 TDI, TDI quattro [8T3]	2,0	120/125	CAHA <D93>; CAHB <D95>	01.08→	0 445 010 546	0 986 437 408		
2.7 TDI [8T3]	2,7	120/140	CAMB <D1W>; CGKA <D4V>; CGKB <D1W>	09.07→	0 445 010 659			
		140	CAMA <D4V>	07.07-05.08	0 445 010 673			
3.0 TDI quattro [8T3]	3,0	155	CCWB <D1V>	03.08-05.10	0 445 010 659			
		176	CAPA <D50>					
			Fg.Nr. →8T..8..044 600	06.07-03.08	0 445 010 331	0 986 437 093		
			Fg.Nr. 8T..8..044 601→	04.08-05.08	0 445 010 659			





## ◀ AUDI

<b>3.0</b>	TDI quattro [8T3]	3,0	176	CCWA <D50> Fg.Nr. →8T..8..044 600 Fg.Nr. 8T..8..044 601→	03.08-04.08 05.08→	<b>0 445 010 331</b>	<b>0 986 437 093</b>
	TDI, TDI quattro [8T3]	3,0	180	CDUC <D43>	08.11→	<b>0 445 010 657</b>	
	TDI, TDI quattro [8T3]	3,0	150/180	CKVB <D43>; CLAB <D1Q>	08.11→	<b>0 445 010 658</b>	
<b>A5 Sportback</b>							
<b>2.0</b>	TDI [8TA]	2,0	105	CMEA <D92>	05.10→	<b>0 445 010 543</b>	<b>0 986 437 410</b>
	TDI, TDI quattro [8TA]	2,0	100/105/ 120/125	CAGA <D92>; CAGB <D94>; CAHA <D93>; CAHB <D95>	09.09→	<b>0 445 010 546</b>	<b>0 986 437 408</b>
<b>2.7</b>	TDI [8TA]	2,7	120/140	CGKA <D4V>; CGKB <D1W>	09.09→	<b>0 445 010 659</b>	
<b>3.0</b>	TDI quattro [8TA]	3,0	155/176	CCWA <D50>; CCWB <D1V>	05.09→	<b>0 445 010 659</b>	
	TDI, TDI quattro [8TA]	3,0	180	CDUC <D43>	08.11→	<b>0 445 010 657</b>	
	TDI, TDI quattro [8TA]	3,0	150/180	CKVB <D43>; CLAB <D1Q>	08.11→	<b>0 445 010 658</b>	
<b>A6</b>							
<b>2.0</b>	TDI, TDI e [4F2; C6]	2,0	100/120/ 125	CAGB <D94>; CAHA <D93>; CAHB <D95>	10.08→	<b>0 445 010 546</b>	<b>0 986 437 408</b>
<b>2.7</b>	TDI [4F2; C6]	2,7	120	CANB	10.08-05.09	<b>0 445 010 659</b>	
			140	CANA <D4V>	10.08-10.10 11.10→	<b>0 445 010 659</b> <b>0 445 010 673</b>	
	TDI quattro [4F2; C6]	2,7	120	CAND <D1W>	10.08-10.10 11.10→	<b>0 445 010 659</b> <b>0 445 010 673</b>	
			140	CANC <D4V>	10.08-10.10 11.10→	<b>0 445 010 659</b> <b>0 445 010 673</b>	
	TDI, TDI quattro [4F2; C6]	2,7	120	BSG Fg.Nr. →4F..6..132 000 Fg.Nr. 4F..6..132 001→	11.04-12.05 01.06-10.08	<b>0 445 010 343</b> <b>0 445 010 331</b>	<b>0 986 437 348</b> <b>0 986 437 093</b>
			132	BPP Fg.Nr. →4F..6..132 000 Fg.Nr. 4F..6..132 001→	11.04-12.05 01.06-10.08	<b>0 445 010 343</b> <b>0 445 010 331</b>	<b>0 986 437 348</b> <b>0 986 437 093</b>
<b>3.0</b>	TDI quattro [4F2; C6]	3,0	155	BNG Fg.Nr. →4F..6..132 000 Fg.Nr. 4F..6..132 001→	04.04-12.05 01.06-10.08	<b>0 445 010 343</b> <b>0 445 010 331</b>	<b>0 986 437 348</b> <b>0 986 437 093</b>
				CDYB <D1V>	10.08-10.10 11.10→	<b>0 445 010 659</b> <b>0 445 010 673</b>	
			165	BMK Fg.Nr. →4F..6..132 000 Fg.Nr. 4F..6..132 001→	04.04-12.05 01.06-05.06	<b>0 445 010 343</b> <b>0 445 010 331</b>	<b>0 986 437 348</b> <b>0 986 437 093</b>
			171	ASB	06.06-10.08	<b>0 445 010 331</b>	<b>0 986 437 093</b>
			176	CDYA <D50>	10.08-10.10 11.10→	<b>0 445 010 659</b> <b>0 445 010 673</b>	
				CDYC <D50>	10.08-10.10 11.10→	<b>0 445 010 659</b> <b>0 445 010 673</b>	
	TDI quattro [4G2; C7]	3,0	180	CDUC <D43>	11.10→	<b>0 445 010 657</b>	
	TDI, TDI quattro [4G2; C7]	3,0	150	CLAA <D1Q>; CLAB <D1Q>	11.10→	<b>0 445 010 658</b>	
<b>A6 Avant</b>							
<b>2.0</b>	TDI, TDI e [4F5; C6]	2,0	100/120/ 125	CAGB <D94>; CAHA <D93>; CAHB <D95>	10.08→	<b>0 445 010 546</b>	<b>0 986 437 408</b>
<b>2.7</b>	TDI [4F5; C6]	2,7	120	CANB	10.08-05.09	<b>0 445 010 659</b>	
			140	CANA <D4V>	10.08-10.10 11.10→	<b>0 445 010 659</b> <b>0 445 010 673</b>	
	TDI quattro [4F5; C6]	2,7	120	CAND <D1W>	10.08-10.10 11.10→	<b>0 445 010 659</b> <b>0 445 010 673</b>	
			140	CANC <D4V>	10.08-10.10 11.10→	<b>0 445 010 659</b> <b>0 445 010 673</b>	
	TDI, TDI quattro [4F5; C6]	2,7	120	BSG Fg.Nr. →4F..6..132 000 Fg.Nr. 4F..6..132 001→	03.05-12.05 01.06-05.06 01.06-10.08	<b>0 445 010 343</b> <b>0 445 010 331</b> <b>0 445 010 331</b>	<b>0 986 437 348</b> <b>0 986 437 093</b> <b>0 986 437 093</b>
			132	BPP Fg.Nr. →4F..6..132 000 Fg.Nr. 4F..6..132 001→	03.05-12.05 01.06-10.08	<b>0 445 010 343</b> <b>0 445 010 331</b>	<b>0 986 437 348</b> <b>0 986 437 093</b>
<b>3.0</b>	TDI [4G5; C7]	3,0	150	CLAA <D1Q>; CLAB <D1Q>	05.11→	<b>0 445 010 658</b>	
			180	CDUC <D43>	05.11→	<b>0 445 010 657</b>	

								
<b>3.0</b> TDI quattro [4F5; C6]	3,0	155	BNG					
			Fg.Nr. →4F..6..132 000		03.05-12.05		<b>0 445 010 343</b>	<b>0 986 437 348</b>
			Fg.Nr. 4F..6..132 001→		01.06-10.08		<b>0 445 010 331</b>	<b>0 986 437 093</b>
			CDYB <D1V>		10.08-10.10		<b>0 445 010 659</b>	
					11.10→		<b>0 445 010 673</b>	
		165	BMK					
			Fg.Nr. →4F..6..132 000		03.05-12.05		<b>0 445 010 343</b>	<b>0 986 437 348</b>
			Fg.Nr. 4F..6..132 001→		01.06-05.06		<b>0 445 010 331</b>	<b>0 986 437 093</b>
		171	ASB		06.06-10.08		<b>0 445 010 331</b>	<b>0 986 437 093</b>
		176	CDYA <D50>		10.08-10.10		<b>0 445 010 659</b>	
					11.10→		<b>0 445 010 673</b>	
			CDYC <D50>		10.08-10.10		<b>0 445 010 659</b>	
					11.10→		<b>0 445 010 673</b>	
<b>A6 Avant Allroad</b>								
<b>2.7</b> TDI [4FH; C6]	2,7	120	CAND <D1W>		10.08-10.10		<b>0 445 010 659</b>	
					11.10→		<b>0 445 010 673</b>	
		120/132	BPP <D1N>; BSG <D1W>		05.06-10.08		<b>0 445 010 331</b>	<b>0 986 437 093</b>
		140	CANC <D4V>		10.08-10.10		<b>0 445 010 659</b>	
					11.10→		<b>0 445 010 673</b>	
<b>3.0</b> TDI [4FH; C6]	3,0	155	CDYB <D1V>		10.08-10.10		<b>0 445 010 659</b>	
					11.10→		<b>0 445 010 673</b>	
		155/171	ASB <D1D>; BNG <D1V>		05.06-10.08		<b>0 445 010 331</b>	<b>0 986 437 093</b>
		176	CDYA <D50>		10.08-10.10		<b>0 445 010 659</b>	
					11.10→		<b>0 445 010 673</b>	
			CDYC <D50>		10.08-10.10		<b>0 445 010 659</b>	
					11.10→		<b>0 445 010 673</b>	
<b>A7 Sportback</b>								
<b>3.0</b> TDI quattro [4GA]	3,0	180	CDUC <TF1>		11.10→		<b>0 445 010 657</b>	
TDI, TDI quattro [4GA]	3,0	150	CLAA <D1Q>; CLAB <D1Q>		12.10→		<b>0 445 010 658</b>	
<b>A8</b>								
<b>3.0</b> TDI quattro [4E; D3]	3,0	155	BNG					
			Fg.Nr. →4E..6..011 520		11.03-09.05		<b>0 445 010 343</b>	<b>0 986 437 348</b>
			Fg.Nr. 4E..6..011 521→		10.05-07.10		<b>0 445 010 331</b>	<b>0 986 437 093</b>
		171	ASB					
			Fg.Nr. →4E..6..011 520		01.04-09.05		<b>0 445 010 343</b>	<b>0 986 437 348</b>
			Fg.Nr. 4E..6..011 521→		10.05-07.10		<b>0 445 010 331</b>	<b>0 986 437 093</b>
TDI quattro [4H; D4]	3,0	150	CLAB <D1Q>		09.11→		<b>0 445 010 658</b>	
		155/184	CDTA; CDTB <D1V>		11.10→		<b>0 445 010 657</b>	
<b>3.3</b> TDI quattro [4D2; D2]	3,3	165	AKF		12.99-08.02			<b>0 986 437 316</b>
<b>4.0</b> TDI quattro [4E; D3]	4,0	202	ASE		05.03-07.05		<b>0 445 010 358</b>	<b>0 986 437 346</b>
<b>4.2</b> TDI quattro [4E; D3]	4,2	235/240	BMC; BVN		01.05-07.10		<b>0 445 010 340</b>	<b>0 986 437 344</b>
<b>Q5</b>								
<b>2.0</b> TDI quattro [8RB]	2,0	100/105/ 120/125	CAGA <D92>; CAGB <D94>; CAHA <D93>; CAHB <D95>		11.08-09.10		<b>0 445 010 546</b>	<b>0 986 437 408</b>
TDI, TDI quattro [8RB]	2,0	100/105/ 120/125	CGLA <D95>; CGLB <D93>; CJCA <D92>; CJCB <D94>		05.10→		<b>0 445 010 551</b>	<b>0 986 437 412</b>
<b>3.0</b> TDI quattro [8RB]	3,0	155/176	CCWA <D50>; CCWB <D1V>		11.08→		<b>0 445 010 659</b>	
<b>Q7</b>								
<b>3.0</b> TDI [4LB]	3,0	150	CJMA <D1Q>		11.10→		<b>0 445 010 658</b>	
		155/171	BUG <D1D>; BUN <D1V>		03.06-05.08		<b>0 445 010 331</b>	<b>0 986 437 093</b>
		155/176	CASA <D50>; CASB <D1V>		09.07-05.10		<b>0 445 010 659</b>	
		165	CATA <D1T>		11.08-10.10		<b>0 445 010 654</b>	
					11.10→		<b>0 445 010 656</b>	
		176	CCMA <D50>		06.09-10.10		<b>0 445 010 654</b>	
					11.10-05.11		<b>0 445 010 656</b>	
		176/180	CJGA <D50>; CJGD <D43>; CLZB <D43>; CRCA <D43>		12.10→		<b>0 445 010 658</b>	
<b>4.2</b> TDI [4LB]	4,1	250	CCFC <D57>		05.10→		<b>0 445 010 664</b>	<b>0 986 437 416</b>
	4,2	240	BTR <D1S>		03.07-06.09		<b>0 445 010 340</b>	<b>0 986 437 344</b>
		250	CCFA <D57>		06.09-05.10		<b>0 445 010 664</b>	<b>0 986 437 416</b>
<b>6.0</b> TDI [4LB]	6,0	368	CCGA <D56>		09.08-03.10		<b>0 445 010 663</b>	<b>0 986 437 414</b>
					04.10→		<b>0 445 010 663</b>	<b>0 986 437 414</b>





◀ AUDI

TT Coupé							
2.0 TDI quattro [8J3]	2,0	125	CBBB		06.08-06.10	0 445 010 546	0 986 437 408
			CFGB		05.10→	0 445 010 551	0 986 437 412
TT Roadster							
2.0 TDI quattro [8J9]	2,0	125	CBBB		06.08-06.10	0 445 010 546	0 986 437 408
			CFGB		05.10→	0 445 010 551	0 986 437 412

**BMW**

Serie X										
X1 23 d xDrive [E 84]	2,0	150	N47 D20D		10.09-11.10	0 445 010 547				
					12.10→	0 445 010 547				
X3 2.0 d [E 83]	2,0	110	20 4D 4 <M 47N>		10.04-09.07	0 445 010 126	0 986 437 323			
				2.0 d, 18 d xDrive, 20 d xDrive [E 83]	2,0	105/120-130	N47 D20...; N47 D20A; N47 D20C	09.07-08.10	0 445 010 506	
				3.0 d [E 83]	3,0	150	30 6D 2 <M 57N>	01.04-09.05	0 445 010 073	0 986 437 320
3.0 d, 3.0 sd, 30 d xDrive, 35 d xDrive [E 83]	3,0	155-160/210	30 6D 3 <M 57N2>; 30 6D 5		09.05-08.10	0 445 010 126	0 986 437 323			
X5 3.0 d [E 53]	3,0	135	30 6D 1 <M 57 D 30>		03.01-09.03	0 445 010 009	0 986 437 004			
				3.0 d, 3.0 sd, 30 d xDrive, 35 d xDrive [E 70]	3,0	155-160/210	30 6D 2 <M 57N>	10.03-10.06	0 445 010 073	0 986 437 320
				30 d xDrive [E 70]	3,0	155-173/210	30 6D 3 <M 57N2>; 30 6D 5	03.07-03.10	0 445 010 126	0 986 437 323
X6 30 d xDrive [E 71]	3,0	180	N57 D30A		04.10→	0 445 010 617				
				30 d xDrive, 35 d xDrive [E 71]	3,0	173/210	30 6D 3 <M 57N2>; 30 6D 5	04.10→	0 445 010 617	
					05.08-03.10	0 445 010 126	0 986 437 323			
Serie 1										
116 d [E 81]	2,0	85	N47 D20...		03.09→	0 445 010 506				
				d [E 87]	2,0	85	N47 D20...	03.09-06.11	0 445 010 506	
118 d [E 81]	2,0	100-105	N47 D20...		05.07→	0 445 010 506				
				d [E 87]	2,0	90	20 4D 4 <M 47N>	09.04-03.07	0 445 010 126	0 986 437 323
					03.07-06.11	0 445 010 506				
120 d [E 81]	2,0	120-130	N47 D20...		05.07→	0 445 010 506				
				d [E 87]	2,0	120	20 4D 4 <M 47N>	09.04-03.07	0 445 010 126	0 986 437 323
					03.07-06.11	0 445 010 506				
123 d [E 81]	2,0	150	N47 D20B		09.07-01.08	0 445 010 506				
				d [E 87]	2,0	150	N47 D20...	02.08→	0 445 010 509	
					09.07-01.08	0 445 010 506				
					02.08-06.11	0 445 010 509				
Serie 1 Cabrio										
118 d [E 88]	2,0	100-105	N47 D20...		09.08→	0 445 010 506				
120 d [E 88]	2,0	120-130	N47 D20...		03.08→	0 445 010 506				
123 d [E 88]	2,0	150	N47 D20B		09.08→	0 445 010 509				
Serie 1 Coupé										
118 d [E 82]	2,0	100-105	N47 D20C		09.09→	0 445 010 506				
120 d [E 82]	2,0	120-130	N47 D20...		10.07→	0 445 010 506				
123 d [E 82]	2,0	150	N47 D20B		10.07-01.08	0 445 010 506				
					02.08→	0 445 010 509				
Serie 3										
316 d [E 90]	2,0	85	N47 D20C		09.09-02.10	0 445 010 506				
318 d [E 46]	2,0	85	20 4D 4 <M 47N>		03.03-03.05	0 445 010 126	0 986 437 323			
				d [E 90]	2,0	90	20 4D 4 <M 47N>	09.05-09.07	0 445 010 126	0 986 437 323
					09.07-02.10	0 445 010 506				
320 d [E 46]	2,0	110	20 4D 4 <M 47N>		09.01-03.05	0 445 010 126	0 986 437 323			
				d [E 90]	2,0	110/120	20 4D 4 <M 47N>	03.05-09.07	0 445 010 126	0 986 437 323
d, d xDrive [E 90]	2,0	130	N47 D20...; N47 D20C		09.07-03.10	0 445 010 506				
325 d [E 90]	3,0	145	30 6D 3 <M 57N2>		09.06-02.10	0 445 010 126	0 986 437 323			
					03.10→	0 445 010 617				
330 d, d xDrive [E 90]	3,0	180	N57 D30A		09.08→	0 445 010 617				
				d, xd [E 46]	3,0	135	30 6D 1 <M 57 D 30>	10.99-04.03	0 445 010 009	0 986 437 004
						150	30 6D 2 <M 57N>	03.03-03.05	0 445 010 073	0 986 437 320
d, xd [E 90]	3,0	170	30 6D 3 <M 57N2>		09.05-08.08	0 445 010 126	0 986 437 323			
335 d [E 90]	3,0	210	30 6D 5 <M 57...>		09.06→	0 445 010 126	0 986 437 323			





<b>Serie 3 Cabrio</b>							
320 d [E 46]	2,0	110	20 4D 4 <M 47N>		01.05-08.06	0 445 010 126	0 986 437 323
d [E 93]	2,0	130	N47 D20...		03.08-02.10	0 445 010 506	
325 d [E 93]	3,0	145	30 6D 3 <M 57N2>		09.07-02.10	0 445 010 126	0 986 437 323
		150	N57 D30A		03.10→	0 445 010 617	
330 d [E 46]	3,0	150	30 6D 2 <M 57N>		04.05-08.06	0 445 010 073	0 986 437 320
d [E 93]	3,0	170	30 6D 3 <M 57N2>		03.07-02.09	0 445 010 126	0 986 437 323
		180	N57 D30A		03.09→	0 445 010 617	
<b>Serie 3 Compact</b>							
318 td [E 46]	2,0	85	20 4D 4 <M 47N>		03.03-12.04	0 445 010 126	0 986 437 323
320 td [E 46]	2,0	110	20 4D 4 <M 47N>		09.01-12.04	0 445 010 126	0 986 437 323
<b>Serie 3 Coupé</b>							
320 d [E 46]	2,0	110	20 4D 4 <M 47N>		09.03-05.06	0 445 010 126	0 986 437 323
d, d xDrive [E 92]	2,0	130	N47 D20...; N47 D20C		03.07-02.10	0 445 010 506	
325 d [E 92]	3,0	145	30 6D 3 <M 57N2>		03.07-02.10	0 445 010 126	0 986 437 323
		150	N57 D30A		03.10→	0 445 010 617	
330 d [E 46]	3,0	150	30 6D 2 <M 57N>		03.03-05.06	0 445 010 073	0 986 437 320
d, d xDrive [E 92]	3,0	180	N57 D30A		09.08→	0 445 010 617	
d, xd [E 92]	3,0	170	30 6D 3 <M 57N2>		09.06-08.08	0 445 010 126	0 986 437 323
335 d [E 92]	3,0	210	30 6D 5		09.06→	0 445 010 126	0 986 437 323
<b>Serie 3 Touring</b>							
318 d [E 46]	2,0	85	20 4D 4 <M 47N>		03.03-09.05	0 445 010 126	0 986 437 323
d [E 91]	2,0	90	20 4D 4 <M 47N>		03.06-09.07	0 445 010 126	0 986 437 323
		100-105	N47 D20...		09.07-02.10	0 445 010 506	
320 d [E 46]	2,0	110	20 4D 4 <M 47N>		09.01-09.05	0 445 010 126	0 986 437 323
d [E 91]	2,0	110/120	20 4D 4 <M 47N>		09.05-09.07	0 445 010 126	0 986 437 323
d, d xDrive [E 91]	2,0	130	N47 D20...; N47 D20C		09.07-02.10	0 445 010 506	
325 d [E 91]	3,0	145	30 6D 3 <M 57N2>		09.06-02.10	0 445 010 126	0 986 437 323
		150	N57 D30A		03.10→	0 445 010 617	
330 d, d xDrive [E 91]	3,0	180	N57 D30A		09.08→	0 445 010 617	
d, xd [E 46]	3,0	135	30 6D 1 <M 57 D 30>		10.99-03.03	0 445 010 009	0 986 437 004
		150	30 6D 2 <M 57N>		03.03-09.05	0 445 010 073	0 986 437 320
d, xd [E 91]	3,0	170	30 6D 3 <M 57N2>		09.05-08.08	0 445 010 126	0 986 437 323
335 d [E 91]	3,0	210	30 6D 5		09.06→	0 445 010 126	0 986 437 323
<b>Serie 5</b>							
520 d [E 60]	2,0	110/120	20 4D 4 <M 47N>		09.05-02.08	0 445 010 126	0 986 437 323
		130	N47 D20...		09.07-02.10	0 445 010 510	
525 d [E 39]	2,5	120	25 6D 1		04.00-07.03	0 445 010 009	0 986 437 004
d [E 60]	2,5	120/130	25 6D 2		05.04-03.07	0 445 010 073	0 986 437 320
d [F 10]	3,0	150	N57 D30A		03.10→	0 445 010 617	
d, d xDrive, xd [E 60]	3,0	145	30 6D 3 <M 57N2>		03.07-02.10	0 445 010 126	0 986 437 323
530 d [E 39]	3,0	135-142	30 6D 1 <M 57 D 30>		08.98-07.03	0 445 010 009	0 986 437 004
d [E 60]	3,0	160	30 6D 2 <M 57N>		07.03-09.05	0 445 010 073	0 986 437 320
d [F 10]	3,0	180	N57 D30A		03.10→	0 445 010 617	
d, d xDrive, xd [E 60]	3,0	170/173	30 6D 3 <M 57N2>		09.05-02.10	0 445 010 126	0 986 437 323
535 d [E 60]	3,0	200	30 6D 4		09.04-03.07	0 445 010 073	0 986 437 320
		210	30 6D 5		03.07-02.10	0 445 010 126	0 986 437 323
<b>Serie 5 GT</b>							
530 d, d xDrive [F 07]	3,0	155/180	N57 D30A		10.09→	0 445 010 617	
<b>Serie 5 Touring</b>							
520 d [E 61]	2,0	110/120	20 4D 4 <M 47N>		09.05-02.08	0 445 010 126	0 986 437 323
		130	N47 D20...		09.07-08.10	0 445 010 510	
525 d [E 39]	2,5	120	25 6D 1		04.00-05.04	0 445 010 009	0 986 437 004
d [E 61]	2,5	120/130	25 6D 2		05.04-03.07	0 445 010 073	0 986 437 320
d [F 11]	3,0	150	N57 D30A		09.10→	0 445 010 617	
d, d xDrive, xd [E 61]	3,0	145	30 6D 3 <M 57N2>		03.07-08.10	0 445 010 126	0 986 437 323
530 d [E 39]	3,0	135-142	30 6D 1 <M 57 D 30>		08.98-05.04	0 445 010 009	0 986 437 004
d [E 61]	3,0	160	30 6D 2 <M 57N>		05.04-09.05	0 445 010 073	0 986 437 320
d [F 11]	3,0	180	N57 D30A		09.10→	0 445 010 617	
d, d xDrive, xd [E 61]	3,0	170/173	30 6D 3 <M 57N2>		09.05-08.10	0 445 010 126	0 986 437 323
535 d [E 61]	3,0	200	30 6D 4		09.04-03.07	0 445 010 073	0 986 437 320
		210	30 6D 5		03.07-08.10	0 445 010 126	0 986 437 323



B



◀ BMW

<b>Serie 6</b>									
635 d [E 63]	3,0	210	30 6D 5		09.07-07.10		0 445 010 126	0 986 437 323	
<b>Serie 6 Cabrio</b>									
635 d [E 64]	3,0	210	30 6D 5		09.07-07.10		0 445 010 126	0 986 437 323	
<b>Serie 7</b>									
730 d [E 38]	3,0	135-142	30 6D 1 <M 57 D 30>		08.98-12.01		0 445 010 009	0 986 437 004	
d [E 65]	3,0	160	30 6D 2 <M 57N>		10.02-03.05		0 445 010 073	0 986 437 320	
			170	30 6D 3 <M 57N2>		04.05-10.08		0 445 010 126	0 986 437 323
d [F 01]	3,0	180	N57 D30A		11.08→		0 445 010 617		
Ld [E 66]	3,0	170	30 6D 3 <M 57N2>		09.05-10.08		0 445 010 126	0 986 437 323	
Ld [F 02]	3,0	180	N57 D30A		03.09→		0 445 010 617		
740 d [E 38]	3,9	180	39 8D 1 <M 67>		10.98-12.01		0 445 010 012	0 986 437 313	
d [E 65]	3,9	190	39 8D 1		10.02-03.05		0 445 010 074	0 986 437 314	
745 d [E 65]	4,4	220/242	44 8D 1		03.05-10.08		0 445 010 108	0 986 437 315	

**CHEVROLET**

<b>Aveo</b>									
1.3 D [KL1T, T300]	1,2	70			09.11→	EU4,TW	0 445 010 293	0 986 437 036	
<b>Aveo Hatchback</b>									
1.3 D [KL1T, T300]	1,2	70			09.11→	EU4,TW	0 445 010 293	0 986 437 036	
<b>Blazer</b>									
2.8 D Electronic	2,8	103	4.07 TCE <Sprint Euro 3>		08.05-05.09		0 445 010 115		
<b>Captiva</b>									
2.0 CDRI, CDRI 4x4 [KL1C,C100]	2,0	93/110	Z20S						
			Fg.Nr. →169709		10.06-12.08		0 445 010 142	0 986 437 032	
<b>Epica</b>									
2.0 CDRI [KL1L,V250]	2,0	110	Z20S						
			Fg.Nr. →090446		09.06→		0 445 010 142	0 986 437 032	
<b>Express 2500</b>									
6.6	6,6	187	LLY		09.05-08.07		0 445 020 037	0 986 437 332	
<b>Express 3500</b>									
6.6	6,6	187	LLY		09.05-08.07		0 445 020 037	0 986 437 332	
<b>Lacetti</b>									
2.0 D [KL1N, J200]	2,0	89	Z20S						
			Fg.Nr. →092448		09.06→		0 445 010 142	0 986 437 032	
<b>Nubira</b>									
2.0 D [KL1N, J200]	2,0	89	Z20S						
			Fg.Nr. →092448		09.06→		0 445 010 142	0 986 437 032	
<b>Nubira Wagon</b>									
2.0 D [KL1N, J200]	2,0	89	Z20S						
			Fg.Nr. →092448		09.06→		0 445 010 142	0 986 437 032	
<b>Silverado 3500</b>									
6.6	6,6	224-231	LB7		09.00-08.03			0 986 437 303	
			LLY		09.04-08.05			0 986 437 308	
					09.05-08.06		0 445 020 037	0 986 437 332	
4x4	6,6	269	LBZ		09.05-08.07		0 445 020 037	0 986 437 332	

**CHRYSLER**

<b>PT Cruiser</b>									
2.2 CRD [PT]	2,2	89-112	EDJ		09.02-12.06		0 445 010 270	0 986 437 102	



l/ccm



kW/(PS)



Typ



## CITROEN

**Berlingo**

1.6 HDi [B9]	1,6	55/66/68	9HF <DV6DTE4>; 9HJ <DV6DTE4 M>; 9HK <DV6ETED M>; 9HN <DV6ETED4>; 9HP <DV6DTE4>	07.10→		0 445 010 552	
		55/66/80	9HS <DV6TED4BU/FAP>; 9HT <DV6B/DV6BUTED4>; 9HV <DV6TED4/FAP>; 9HX <DV6ATED4/DV6AUTED4>; 9HZ <DV6TED4>	05.08→		0 445 010 296	0 986 437 028
HDi [M59]	1,6	55/66	9HW <DV6B>; 9HX <DV6ATED4>	09.05-04.08		0 445 010 296	0 986 437 028
2.0 HDi [M49]	2,0	66	RHY <DW10TD>				
			Org.Nr. →8994	12.99-06.01	BO	0 445 010 010	0 986 437 005
			Org.Nr. 8995→	07.01-11.02	BO	0 445 010 046	0 986 437 017
HDi	2,0	66	DW10TD	10.00→		0 445 010 010	0 986 437 005

**C-Crosser**

2.2 HDi 4x4 [I4]	2,2	115	4HK <DW12ME5>; 4HN <DW12METED4/FAP>	09.07→		0 445 010 367	0 986 437 034
------------------	-----	-----	-------------------------------------	--------	--	---------------	---------------

**C2**

1.4 HDi [A6]	1,4	50	8H... <DV4TD>	09.03-12.09	BO	0 445 010 296	0 986 437 028
1.6 HDi [A6]	1,6	80	9HZ <DV6TED4>	07.07-05.09		0 445 010 296	0 986 437 028

**C3**

1.4 HDi	1,4	52	8HW <DV4TD>	07.03→	BO	0 445 010 296	0 986 437 028
HDi [A31]	1,4	50	8HZ <DV4TD>	09.05-09.09	BO	0 445 010 296	0 986 437 028
HDi [A51]	1,4	50	8H... <DV4C>	06.10→		0 445 010 552	
			8HZ <DV4TD>	09.09→		0 445 010 296	0 986 437 028
1.6 HDi [A31]	1,6	66/80	9HX <DV6ATED4>; 9HZ <DV6TED4>	09.05-12.09		0 445 010 296	0 986 437 028
HDi [A51]	1,6	66	9HX <DV6ATED4>	09.09→		0 445 010 296	0 986 437 028
		68	9HP <DV6DTE4>	01.10→		0 445 010 552	

**C3 Picasso**

1.6 HDi [A58]	1,6	66/80	9HX <DV6ATED4>; 9HZ <DV6TED4>	02.09→		0 445 010 296	0 986 437 028
		68	9HP <DV6DTE4>	03.10→		0 445 010 552	

**C3-Pluriel**

1.4 HDi [A42]	1,4	50	8H... <DV4TD>	10.03-01.10	BO	0 445 010 296	0 986 437 028
---------------	-----	----	---------------	-------------	----	---------------	---------------

**C4**

1.6 HDi [B5]	1,6	66/80	9H... <DV6TED4>; 9HV <DV6TED4/FAP>; 9HX <DV6ATED4>	11.04→		0 445 010 296	0 986 437 028
HDi [B71]	1,6	68	9HJ <DV6DTE4 M>; 9HP <DV6DTE4>	09.10→		0 445 010 552	

**C4 Coupé**

1.6 HDi [B5]	1,6	66/80	9H... <DV6TED4>; 9HV <DV6TED4/FAP>; 9HX <DV6ATED4>	11.04→		0 445 010 296	0 986 437 028
--------------	-----	-------	---	--------	--	---------------	---------------

**C4 Grand Picasso**

1.6 HDi [B58]	1,6	80	9H... <DV6TED4>	10.06→		0 445 010 296	0 986 437 028
---------------	-----	----	-----------------	--------	--	---------------	---------------

**C4 Picasso**

1.6 HDi [B58]	1,6	80	9H... <DV6TED4>	02.07→		0 445 010 296	0 986 437 028
---------------	-----	----	-----------------	--------	--	---------------	---------------

**C5**

1.6 HDi [X3]	1,6	80	9H... <DV6TED4>	10.04-03.08		0 445 010 296	0 986 437 028
HDi [X7]	1,6	80	9HZ <DV6TED4>	04.08-07.10		0 445 010 296	0 986 437 028
2.0 HDi [X4]	2,0	66	RHY <DW10TD>				
			Org.Nr. →8945	03.01-05.01	BO	0 445 010 010	0 986 437 005
			Org.Nr. 8946→	06.01-09.04	BO	0 445 010 046	0 986 437 017
		79	RHS <DW10ATED/FAP>				
			Org.Nr. →8945	03.01-05.01		0 445 010 010	0 986 437 005
			Org.Nr. 8946→	06.01-09.04		0 445 010 046	0 986 437 017
		80	RHZ <DW10ATED>				
			Org.Nr. →8945	03.01-05.01		0 445 010 010	0 986 437 005
			Org.Nr. 8946→	06.01-09.04		0 445 010 046	0 986 437 017
2.2 HDi [X3]	2,2	98	4HX <DW12TED4>	10.04-09.05		0 445 010 021	0 986 437 012
		125	4H... <DW12BTED4>	03.06-03.08		0 445 010 367	0 986 437 034
HDi [X4]	2,2	98	4HX <DW12TED4>	03.01-09.04		0 445 010 021	0 986 437 012
HDi [X7]	2,2	125	4H... <DW12BTED4>	04.08-09.09		0 445 010 367	0 986 437 034
		150	4HL <DW12C>	07.10→		0 445 010 367	0 986 437 034
3.0 HDi 24V [X7]	3,0	177	X8Z <DT20C>	07.09→		0 445 010 614	



C



◀ CITROEN

C5 Break								
1.6 HDi [X3]	1,6	80	9H... <DV6TED4>		10.04-03.08		0 445 010 296 0 986 437 028	
2.0 HDi [X4]	2,0	66	RHY <DW10TD>		06.01-09.04	BO	0 445 010 046 0 986 437 017	
			79/80	RHS <DW10ATED/FAP>; RHZ <DW10ATED>		06.01-09.04		0 445 010 046 0 986 437 017
2.2 HDi [X3]	2,2	98	4HX <DW12TED4>		10.04-09.05		0 445 010 021 0 986 437 012	
			125	4H ... <DW12BTED4>		04.06-03.08		0 445 010 367 0 986 437 034
HDi [X4]	2,2	98	4HX <DW12TED4>		06.01-09.04		0 445 010 021 0 986 437 012	
C5 Tourer								
1.6 HDi [X7]	1,6	80	9HZ <DV6TED4>		04.08-07.10		0 445 010 296 0 986 437 028	
2.2 HDi [X7]	2,2	125	4H... <DW12BTED4>		04.08-09.09		0 445 010 367 0 986 437 034	
		150	4HL <DW12C>		07.10→		0 445 010 367 0 986 437 034	
3.0 HDi 24V [X7]	3,0	177	X8Z <DT20C>		07.09→		0 445 010 614	
C6								
2.2 HDi [X6]	2,2	125	4H... <DW12BTED4>		06.06-07.10		0 445 010 367 0 986 437 034	
3.0 HDi 24V [X6]	3,0	177	X8Z <DT20C>		07.09→		0 445 010 614	
C8								
2.0 HDi [V3]	2,0	81	RH... <DW10ATED4/FAP>; RHW <DW10ATED4>		06.02-12.06		0 445 010 021 0 986 437 012	
2.2 HDi [V3]	2,2	94	4HW <DW12TED4/FAP>		06.02-07.06		0 445 010 021 0 986 437 012	
		125	4H ... <DW12BTED4>		09.07-05.10		0 445 010 367 0 986 437 034	
DS3								
1.4 HDi 8V [A55]	1,4	50	8H... <DV4C>		03.10→		0 445 010 552	
1.6 HDi [A55]	1,6	68	9HP <DV6DTED>		01.10→		0 445 010 552	
DS4								
1.6 HDi 16V [B75]	1,6	68	9HP <DV6DTED>		03.11→		0 445 010 552	
Evasion								
2.0 HDi [U60]	2,0	80	RHZ <DW10ATED/L3>					
			Org.Nr. →9008		01.99-07.01		0 445 010 010 0 986 437 005	
			Org.Nr. 9009→		08.01-07.02		0 445 010 046 0 986 437 017	
		81	RHW <DW10ATED4/L4>		06.00-07.02		0 445 010 021 0 986 437 012	
Jumpy								
1.6 HDi [G9]	1,6	66	9HM <DV6U C>		12.10→		0 445 010 552	
			9HU <DV6UTED4>		02.07→		0 445 010 296 0 986 437 028	
2.0 HDi [U64]	2,0	70	RHX <DW10BTED>					
			Org.Nr. →9008		10.99-07.01		0 445 010 010 0 986 437 005	
			Org.Nr. 9009→10558		08.01-10.05		0 445 010 046 0 986 437 017	
			Org.Nr. 10559→		11.05-01.07		0 445 010 132 0 986 437 018	
			80	RHZ <DW10ATED>				
			Org.Nr. →9008		10.99-07.01		0 445 010 010 0 986 437 005	
		Org.Nr. 9009→		08.01-01.07		0 445 010 046 0 986 437 017		
		81	RHW <DW10ATED4>		06.00-01.07		0 445 010 021 0 986 437 012	
Nemo								
1.4 HDi [A9]	1,4	50	8HS <DV4TED>		02.08→		0 445 010 296 0 986 437 028	
Xantia								
2.0 HDi [X2]	2,0	66/81	RHY <DW10TD>; RHZ <DW10ATED>		10.98-12.01		0 445 010 010 0 986 437 005	
Xantia Break								
2.0 HDi [X2]	2,0	66/81	RHY <DW10TD>; RHZ <DW10ATED>		10.98-12.01		0 445 010 010 0 986 437 005	
Xsara								
1.4 HDi [N7]	1,4	50	8HZ <DV4TD>					
			Org.Nr. →10100		01.03-07.04		0 445 010 042 0 986 437 309	
			Org.Nr. 10101→		08.04-12.05		0 445 010 296 0 986 437 028	
2.0 HDi [N6]	2,0	66	RHY <DW10TD>		02.99-08.00		0 445 010 010 0 986 437 005	
HDi [N7]	2,0	66	RHY <DW10TD>					
			Org.Nr. →8945		09.00-05.01	BO	0 445 010 010 0 986 437 005	
			Org.Nr. 8946→		06.01-12.05	BO	0 445 010 046 0 986 437 017	
			80	RHZ <DW10ATED>				
			Org.Nr. →8945		09.00-05.01		0 445 010 010 0 986 437 005	
			Org.Nr. 8946→		06.01-12.05		0 445 010 046 0 986 437 017	
Xsara Break								
1.4 HDi [N7]	1,4	50	8HZ <DV4TD>					
			Org.Nr. →10100		01.03-07.04		0 445 010 042 0 986 437 309	
			Org.Nr. 10101→		08.04-12.05		0 445 010 296 0 986 437 028	
2.0 HDi [N6]	2,0	66	RHY <DW10TD>		02.99-08.00		0 445 010 010 0 986 437 005	







<b>2.0 HDi [N7]</b>	2,0	66	RHY <DW10TD>				
			Org.Nr. →8945	09.00-05.01	BO	<b>0 445 010 010</b>	<b>0 986 437 005</b>
			Org.Nr. 8946→	06.01-03.10	BO	<b>0 445 010 046</b>	<b>0 986 437 017</b>
		80	RHZ <DW10ATED>				
			Org.Nr. →8945	09.00-05.01		<b>0 445 010 010</b>	<b>0 986 437 005</b>
			Org.Nr. 8946→	06.01-03.10		<b>0 445 010 046</b>	<b>0 986 437 017</b>
<b>Xsara Coupé</b>							
<b>2.0 HDi [N6]</b>	2,0	66	RHY <DW10TD>	02.99-08.00		<b>0 445 010 010</b>	<b>0 986 437 005</b>
HDi [N7]	2,0	66	RHY <DW10TD>				
			Org.Nr. →8945	09.00-05.01	BO	<b>0 445 010 010</b>	<b>0 986 437 005</b>
			Org.Nr. 8946→	06.01-12.05	BO	<b>0 445 010 046</b>	<b>0 986 437 017</b>
		80	RHZ <DW10ATED>				
			Org.Nr. →8945	09.00-05.01		<b>0 445 010 010</b>	<b>0 986 437 005</b>
			Org.Nr. 8946→	06.01-12.05		<b>0 445 010 046</b>	<b>0 986 437 017</b>
<b>Xsara Picasso</b>							
<b>1.6 HDi [N68]</b>	1,6	66	9HX <DV6ATED4>	09.05-04.10		<b>0 445 010 296</b>	<b>0 986 437 028</b>
		80	9H... <DV6TED4>				
			Org.Nr. →10261	05.04-12.04	MPR	<b>0 445 010 089</b>	<b>0 986 437 322</b>
			Org.Nr. →10465	05.04-07.05	MPR	<b>0 445 010 089</b>	<b>0 986 437 322</b>
			Org.Nr. 10262→	01.05-04.10	MPR	<b>0 445 010 296</b>	<b>0 986 437 028</b>
			Org.Nr. 10466→	08.05-04.10	MPR	<b>0 445 010 296</b>	<b>0 986 437 028</b>
<b>2.0 HDi</b>	2,0	80	<DW10>	10.00→		<b>0 445 010 010</b>	<b>0 986 437 005</b>
HDi [N68]	2,0	66	RHY <DW10TD>				
			Org.Nr. →8945	01.00-05.01		<b>0 445 010 010</b>	<b>0 986 437 005</b>
			Org.Nr. 8946→10262	06.01-12.04		<b>0 445 010 046</b>	<b>0 986 437 017</b>
			Org.Nr. 10263→	01.05-04.10		<b>0 445 010 132</b>	<b>0 986 437 018</b>

**DAEWOO**

<b>Winstorm Max</b>							
<b>2.0 VCDi</b>	2,0	110	2.0 VCDi	06.06-08.07		<b>0 445 010 142</b>	<b>0 986 437 032</b>

**DODGE**

<b>Ram 2500 Pickup</b>							
<b>5.9 , 4x4</b>	5,9	160-175/	ETC; ETH	09.02-08.08		<b>0 445 020 039</b>	<b>0 986 437 304</b>
<b>Ram 3500 Pickup</b>							
<b>5.9</b>	5,9	242	ETH	09.03-08.08		<b>0 445 020 039</b>	
				09.04-08.08			<b>0 986 437 304</b>
, 4x4	5,9	160-175	ETC	09.02-08.04		<b>0 445 020 039</b>	<b>0 986 437 304</b>
4x4	5,9	242	ETH	09.03-08.08		<b>0 445 020 039</b>	
				09.04-08.08			<b>0 986 437 304</b>
<b>6.7</b>	6,7	261		09.06-08.07		<b>0 445 020 072</b>	<b>0 986 437 333</b>
				09.07-08.08		<b>0 445 020 039</b>	<b>0 986 437 304</b>

**FIAT**

<b>Albea</b>							
<b>1.3 JTD 16V [172..]</b>	1,3	52	188 A 9.000 <M40>	07.03→		<b>0 445 010 276</b>	<b>0 986 437 023</b>
<b>Brava</b>							
<b>1.9 JTD [182..]</b>	1,9	76	182 B 4.000 <M25>; 182 B 9.000 <M26>	11.98-09.01		<b>0 445 010 007</b>	<b>0 986 437 002</b>
<b>Bravo</b>							
<b>1.6 JTD [198]</b>	1,6	66/77/88	198 A 2.000; 198 A 3.000; 198 A 6.000	03.10→		<b>0 445 010 185</b>	
JTD 8V, JTD 16V [198]	1,6	77/88	198 A 2.000 <M78>; 198 A 3.000 <M76>	10.07-12.09		<b>0 445 010 185</b>	
<b>1.9 JTD [182..]</b>	1,9	76	182 B 4.000 <M25>; 182 B 9.000 <M26>	11.98-09.01		<b>0 445 010 007</b>	<b>0 986 437 002</b>
JTD 8V [198]	1,9	66/85/88	192 A 8.000 <M88>; 192 B 4.000 <M87>; 192 B 5.000 <M83>	03.07-12.09		<b>0 445 010 166</b>	
JTD 16V [198]	1,9	110	937 A 5.000 <M92>	04.07-12.09		<b>0 445 010 185</b>	
<b>2.0 JTD [198]</b>	2,0	121	198 A 5.000	03.10→		<b>0 445 010 185</b>	
JTD 16V [198]	2,0	120	198 A 5.000 <M120>	10.08-12.09		<b>0 445 010 185</b>	





◀ FIAT

Croma						
1.9 JTD 16V [194..]	1,9	100/110	939 A 1.000 <M91>; 939 A 2.000 <M92>	06.05-12.10		0 445 010 185
2.4 JTD [194..]	2,4	147	939 A 3.000 <M95>	06.05-12.10		0 445 010 123
Doblo						
1.3 JTD [119..]	1,3	62	223 A 9.000 <M71>			
			Mot.Nr. →1438789	10.05-09.06		0 445 010 286 0 986 437 035
			Mot.Nr. 1438790→	10.06-12.10		0 445 010 293 0 986 437 036
JTD [152..]	1,3	66	199 A 2.000 <M72>	10.09→		0 445 010 293 0 986 437 036
JTD, JTD 16V [119..]	1,3	51/55	188 A 9.000 <M20>; 199 A 2.000 <M73>	02.04-12.10		0 445 010 276 0 986 437 023
1.6 JTD [152..]	1,6	66/77	182 B 6.000 <M76>	10.09→	SSJ	0 445 010 185
1.9 JTD [119..]	1,9	74/77	182 B 9.000 <M15>; 223 A 7.000 <M16/M30>	10.01-09.05		0 445 010 007 0 986 437 002
			223 B 1.000 <M84>; 223 B 2.000 <M86>	10.05-12.10		0 445 010 071
		88	186 A 9.000 <M88>	01.06-12.10		0 445 010 166
2.0 JTD [152..]	2,0	100	<M120>	10.09→	SSJ	0 445 010 185
Doblo Cargo						
1.3 JTD [223..]	1,3	62	223 A 9.000 <M71>			
			Mot.Nr. →1438789	10.05-09.06		0 445 010 286 0 986 437 035
			Mot.Nr. 1438790→	10.06-12.10		0 445 010 293 0 986 437 036
JTD [263..]	1,3	66	<M72>	10.09→		0 445 010 293 0 986 437 036
JTD, JTD 16V [223..]	1,3	51/55	188 A 9.000 <M20>; 199 A 2.000 <M73>	02.04-12.10		0 445 010 276 0 986 437 023
1.6 JTD [263..]	1,6	66/77	182 B 6.000 <M76>	10.09→	SSJ	0 445 010 185
1.9 JTD [223..]	1,9	74/77	182 B 9.000 <M15>; 223 A 7.000 <M16/M30>	10.01-09.05		0 445 010 007 0 986 437 002
			223 B 2.000 <M86>; 223 B 1000 <M84>	10.05-12.10		0 445 010 071
		88	186 A 9.000 <M88>	01.06-12.10		0 445 010 166
2.0 JTD [263..]	2,0	100	<M120>	10.09→	SSJ	0 445 010 185
Fiorino						
1.3 MJTD [225..]	1,3	55	199 A 2.000 <M73>	12.07→		0 445 010 276 0 986 437 023
Freemont						
2.0 , 4x4	2,0	103/125	940A5000; 940A45000	06.11→		0 445 010 306
Idea						
1.3 JTD 16V [135..]	1,3	52	188 A 9.000 <M30>	01.04→		0 445 010 276 0 986 437 023
		66	199 A 3.000 <M72>			
			Mot.Nr. →1438789	11.04-09.06		0 445 010 286 0 986 437 035
			Mot.Nr. 1438790→	10.06→		0 445 010 293 0 986 437 036
1.6 JTD 16V [135..]	1,6	88	350 A 2.000 <M78>	04.08→		0 445 010 185
1.9 JTD 8V [135..]	1,9	74	188 B 2.000 <M40>	01.04→		0 445 010 071
Linea						
1.3 JTD [110..]	1,3	63/66	199 A 3.000 <M70>; 199 A 3.000 <M72>	03.07→		0 445 010 293 0 986 437 036
1.6 JTD [110..]	1,6	77	198 A 3.000 <M76>	10.08→		0 445 010 185
Marea						
1.9 JTD, JTD S.W. [185..]	1,9	74/77/81	182 B 4.000 <M1>; 182 B 9.000 <M5>; 186 A 6.000 <M4>	03.99-09.02		0 445 010 007 0 986 437 002
2.4 JTD [185..]	2,4	100	185 A 6.000 <M3>	03.99-09.02		0 445 010 006 0 986 437 001
Marengo						
1.9 JTD [285..]	1,9	77/81	182 B 4.000 <M1>; 186 A 6.000 <M4>	03.99-09.02		0 445 010 007 0 986 437 002
Multipla						
1.9 JTD [186..]	1,9	77/81/85	182 B 4.000 <M5>; 186 A 6.000 <M6>; 186 A 8.000 <M7/EU3>	01.99-12.10		0 445 010 007 0 986 437 002
		85/88	186 A 8.000 <M87/EU4>; 186 A 9.000 <M88/EU4>	01.06-12.10		0 445 010 166
Palio						
1.3 JTD 16V [171..]	1,3	52	188 A 9.000 <M40>	07.03→		0 445 010 276 0 986 437 023
Palio Weekend						
1.9 JTD [173..]	1,9	57/80	188 A 2.000 <M30>	10.01→		0 445 010 007 0 986 437 002
Panda						
1.3 [169..]	1,3	55		02.12→		0 445 010 265
, 4x4 [169..]	1,3	52	188 A 8.000	01.09→	EU4	0 445 010 276 0 986 437 023
JTD, JTD 4x4 [169..]	1,3	52/55	169 A 1.000 <M73>; 188 A 8.000 <M10>	01.04-12.09		0 445 010 276 0 986 437 023
Punto						
1.3 MJTD 16V [188]	1,3	52	188 A 9.000 <M20>	07.03-12.10		0 445 010 276 0 986 437 023
1.9 JTD, JTD 8V [188]	1,9	59/62,5/ 63	188 A 2.000 <M5>; 188 A 7.000 <M6>; 188 A 7.000 <M25>	07.99-12.10		0 445 010 007 0 986 437 002
JTD 8V [188]	1,9	74	188 B 2.000 <M30>	07.03-12.10		0 445 010 071





<b>Punto Evo</b>									
<b>1.3</b> JTD [199]	1,3	55	199 A 2.000 <M73>	10.09→	EU4	<b>0 445 010 276</b>	<b>0 986 437 023</b>		
						EU5	<b>0 445 010 293</b>	<b>0 986 437 036</b>	
		66	199 A 3.000 <M72>	10.09→	EU4	<b>0 445 010 293</b>	<b>0 986 437 036</b>		
		70	199 B 1.000	10.09→	EU5	<b>0 445 010 276</b>	<b>0 986 437 023</b>		
<b>1.6</b> JTD [199]	1,6	88	955 A 3.000 <M78>	10.09→	SSJ	<b>0 445 010 185</b>			
<b>Punto Grande</b>									
<b>1.3</b> MJTD [199]	1,3	55	199 A 2.000 <M73>	10.05→		<b>0 445 010 276</b>	<b>0 986 437 023</b>		
		66	199 A 3.000 <M72>						
				Mot.Nr. →1438789	10.05→		<b>0 445 010 286</b>	<b>0 986 437 035</b>	
			Mot.Nr. 1438790→	10.05→		<b>0 445 010 293</b>	<b>0 986 437 036</b>		
<b>1.6</b> JTD [199]	1,6	88	955 A 3.000 <M78>	08.08→		<b>0 445 010 185</b>			
<b>Punto VAN</b>									
<b>1.3</b> MJTD 16V [288]	1,3	52	188 A 9.000 <M20>	07.03→		<b>0 445 010 276</b>	<b>0 986 437 023</b>		
<b>1.9</b> JTD, JTD 8V [288]	1,9	63/85	188 A 7.000 <M6>; 188 A 7.000 <M25>	05.99→		<b>0 445 010 007</b>	<b>0 986 437 002</b>		
<b>Qubo</b>									
<b>1.3</b> MJTD [300..]	1,3	55	199 A2.000 <M73>	09.08→		<b>0 445 010 276</b>	<b>0 986 437 023</b>		
		70	199 B1.000	09.10→	TW	<b>0 445 010 265</b>			
						<b>0 445 010 310</b>	<b>0 986 437 038</b>		
<b>Scudo</b>									
<b>2.0</b> 8V JTD [222..]	2,0	70/81	RHX <M7/M14>; RHZ <M6/M13>						
			Ricam.Nr 9009→	08.01-05.04		<b>0 445 010 046</b>	<b>0 986 437 017</b>		
			RHX <M14>; RHZ <M13>						
			Ricam.Nr →10559	06.04-10.05		<b>0 445 010 046</b>	<b>0 986 437 017</b>		
16V JTD [222..]	2,0	81	RHM <M11>; RHW <M11>	09.00-01.07		<b>0 445 010 021</b>	<b>0 986 437 012</b>		
<b>Sedici</b>									
<b>1.9</b> JTD, JTD 4x4 [189]	1,9	88	D19AA <M88>						
			Mot.Nr. →5016433	05.06→		<b>0 445 010 097</b>	<b>0 986 437 025</b>		
			Mot.Nr. 5016434→	05.06→		<b>0 445 010 288</b>	<b>0 986 437 025</b>		
<b>Stilo</b>									
<b>1.9</b> JTD	1,9	85		06.02-12.07		<b>0 445 010 007</b>	<b>0 986 437 002</b>		
JTD 8V [192..]	1,9	59/74/85	192 A 1.000 <M50>; 192 A 3.000 <M40>; 192 A 9.000 <M45>	10.01-12.07		<b>0 445 010 007</b>	<b>0 986 437 002</b>		
		66/85/88	192 A 8.000 <M88>; 192 B 5.000 <M83>; 937 A 7.000 <M87>	01.06-12.07		<b>0 445 010 166</b>			
JTD 16V [192..]	1,9	93/100/ 103	192 A 5.000 <M60>; 192 B 1.000 <M62>; 937 A 4.000 <M61>	01.04-12.07		<b>0 445 010 071</b>			
		110	937 A 5.000 <M92>	07.05-03.07		<b>0 445 010 166</b>			
				04.07-12.07		<b>0 445 010 185</b>			
<b>Stilo Multi Wagon</b>									
<b>1.9</b> JTD 8V [192..]	1,9	59/85	192 A 1.000 <M50>; 192 A 3.000 <M40>	10.02-12.07		<b>0 445 010 007</b>	<b>0 986 437 002</b>		
		66/85/88	192 A 8.000 <M88>; 192 B 5.000 <M83>; 937 A 7.000 <M87>	01.06-12.07		<b>0 445 010 166</b>			
		74	192 A 9.000 <M45>	09.04-12.07		<b>0 445 010 007</b>	<b>0 986 437 002</b>		
JTD 16V [192..]	1,9	93/100	192 B 1.000 <M62>; 937 A 4.000 <M61>	09.04-12.07		<b>0 445 010 071</b>			
		103	192 A 5.000 <M60>	01.04-12.07		<b>0 445 010 071</b>			
		110	937 A 5.000 <M92>	07.05-03.07		<b>0 445 010 166</b>			
				04.07-12.07		<b>0 445 010 185</b>			
<b>Strada</b>									
<b>1.3</b> JTD [278]	1,3	63	223 A 9.000 <M71>	07.05-08.06		<b>0 445 010 286</b>	<b>0 986 437 035</b>		
				09.06→		<b>0 445 010 293</b>	<b>0 986 437 036</b>		
<b>1.9</b> JTD [278]	1,9	59	188 A 2.000 <M50>	04.03-06.05		<b>0 445 010 007</b>	<b>0 986 437 002</b>		
<b>Ulysse</b>									
<b>2.0</b> JTD 8V [121..]	2,0	80	RHZ <M9>						
			Ricam.Nr 9009→	08.01-09.02		<b>0 445 010 046</b>	<b>0 986 437 017</b>		
JTD 16V [121..]	2,0	80	RHW <M11>	11.00-09.02		<b>0 445 010 021</b>	<b>0 986 437 012</b>		
16V JTD [179..]	2,0	79/80	RHM <M7>; RHW <M5>	10.02-01.06		<b>0 445 010 021</b>	<b>0 986 437 012</b>		
<b>2.2</b> 16V JTD [179..]	2,2	94	4HW <M10>	10.02-09.07		<b>0 445 010 021</b>	<b>0 986 437 012</b>		
		125	4HT <M11>; 4H01 <M12/M13>	10.07-12.10		<b>0 445 010 139</b>	<b>0 986 437 034</b>		





◀ FIAT

<b>500</b>							
1.3 MJTD [150]	1,3	55	169 A 1.000 <M73>	07.07→	0 445 010 276	0 986 437 023	
		70	199 B 1.000 <M95>	01.10→	0 445 010 293	0 986 437 036	
<b>500 Cabrio</b>							
1.3 MJTD [150]	1,3	55	169 A 1.000	07.09→	0 445 010 276	0 986 437 023	
		70	199 B 1.000	01.10→	0 445 010 292		

**FORD**

<b>C-MAX</b>							
1.6 TDCi [07]	1,6	66/80	<Duratorq>; <Duratorq-TDCi>	03.07-07.10	0 445 010 296	0 986 437 028	
<b>Fiesta V</b>							
1.6 TDCi [02]	1,6	66	HHJ... <Duratorq TDCi>	11.04-09.08	0 445 010 296	0 986 437 028	
<b>Fiesta VI</b>							
1.6 TDCi [08]	1,6	55/66	HHJ... <Euro4>; HHJF <Euro4>	07.08→	0 445 010 296	0 986 437 028	
<b>Focus C-MAX</b>							
1.6 TDCi [04]	1,6	66	HHD... <Duratorq>	11.04-03.07	0 445 010 296	0 986 437 028	
		80	G8D... <Duratorq-TDCi>	06.03-04.05	0 445 010 089	0 986 437 322	
				05.05-03.07	0 445 010 296	0 986 437 028	
<b>Focus II</b>							
1.6 TDCi [04]	1,6	66	HHD... <Duratorq>	07.04-01.08	0 445 010 296	0 986 437 028	
		80	G8D... <Duratorq>	07.04-04.05	0 445 010 089	0 986 437 322	
				05.05-01.08	0 445 010 296	0 986 437 028	
TDCi [08]	1,6	66/80	GPD... <Euro4/Euro5>; G8D... <Euro3/Euro4/Euro5>; HHD... <Euro3/Euro4>	12.07→	0 445 010 296	0 986 437 028	
<b>Focus II Turnier</b>							
1.6 TDCi [04]	1,6	66	HHD... <Duratorq>	07.04-01.08	0 445 010 296	0 986 437 028	
		80	G8D... <Duratorq>	07.04-04.05	0 445 010 089	0 986 437 322	
				05.05-01.08	0 445 010 296	0 986 437 028	
TDCi [08]	1,6	66/80	GPD... <Euro4/Euro5>; G8D... <Euro3/Euro4/Euro5>; HHD... <Euro3/Euro4>	12.07→	0 445 010 296	0 986 437 028	
<b>Fusion</b>							
1.6 TDCi [02]	1,6	66	HHJ... <Euro3/Euro4>	11.04→	0 445 010 296	0 986 437 028	
<b>Galaxy</b>							
2.2 TDCi [06]	2,2	129/147	KNWA <Euro5>; Q4BA <Euro4>	03.08→	0 445 010 367	0 986 437 034	
<b>Ka</b>							
1.3 TDCi [08]	1,3	55	169 A... <Euro4/Euro5>	09.08-10.10	0 445 010 276		
<b>Mondeo IV</b>							
2.2 TDCi [07]	2,2	129/147	KNBA <Euro5>; Q4BA <Euro4>	03.08→	0 445 010 367	0 986 437 034	
<b>Mondeo IV Turnier</b>							
2.2 TDCi [07]	2,2	129/147	KNBA <Euro5>; Q4BA <Euro4>	03.08→	0 445 010 367	0 986 437 034	
<b>S-MAX</b>							
2.2 TDCi [06]	2,2	129/147	KNWA <Euro4>; Q4BA <Euro4>	03.08→	0 445 010 367	0 986 437 034	

**F GMC (GENERAL MOTORS CORP.)**

<b>Sierra 2500 HD</b>							
6.6	6,6	231	LLY	09.04-08.05	0 445 020 030	0 986 437 308	
		4x4	LB7	09.00-08.03		0 986 437 308	
<b>Sierra 3500</b>							
6.6 TD	6,6	231	LLY	09.04-08.05	0 445 020 030	0 986 437 308	
		TD, TD 4x4	LB7	10.00-08.03		0 986 437 308	



**HONDA**

<b>Accord</b>						
2.2 CTDi [CL/CN/CM]	2,2	103	N22A1		01.05-06.08	<b>0 445 010 141</b>
i-DTEC, i-DTEC Type S [CU/CW]	2,2	110/132	N22B1; N22B2		07.08→	<b>0 445 010 612</b>
<b>Accord Tourer</b>						
2.2 CTDi [CL/CN/CM]	2,2	103	N22A1		01.05-08.08	<b>0 445 010 141</b>
i-DTEC, i-DTEC Type S [CU/CW]	2,2	110/132	N22B1; N22B2		09.08→	<b>0 445 010 612</b>
<b>Civic Hatchback</b>						
2.2 CTDi [FK/FN]	2,2	103	N22A2		09.05→	<b>0 445 010 141</b>
<b>CR-V</b>						
2.2 CTDi 4x4 [RD]	2,2	103	N22A2		02.05-09.06	<b>0 445 010 141</b>
CTDi 4x4 [RE]	2,2	103	N22A2		01.07-12.09	<b>0 445 010 141</b>
i-DTEC 4x4 [RE]	2,2	110	N22B3		01.10→	<b>0 445 010 612</b>
<b>FR-V</b>						
2.2 CTDi [BE]	2,2	103	N22A1		07.05-06.09	<b>0 445 010 141</b>

**HYUNDAI**

<b>Accent</b>						
1.5 CRDi [MC]	1,5	81	D4FA <1.5L-U>		07.08→	<b>0 445 010 290 0 986 437 042</b>
CRDi [LC]	1,5	57-60	D3-EA		01.02-06.06	<b>0 445 010 280 0 986 437 021</b> <b>0 986 437 081</b>
<b>Accent Hatchback</b>						
1.5 CRDi [MC]	1,5	81	D4FA <1.5L-U>		07.08→	<b>0 445 010 290 0 986 437 042</b>
CRDi [LC]	1,5	57-60	D3-EA		01.02-06.06	<b>0 445 010 280 0 986 437 021</b> <b>0 986 437 081</b>
<b>Elantra</b>						
1.6 CRDi [HD]	1,6	85	D4FB <1C 1,6L-U>		07.08→	<b>0 445 010 290 0 986 437 042</b>
2.0 CRDi [XD]	2,0	83	D4EA <2.0L TCI>		06.01-08.06	<b>0 445 010 279 0 986 437 020</b>
<b>Elantra Hatchback</b>						
2.0 CRDi [XD]	2,0	83	D4EA <2.0L TCI>		06.01-08.06	<b>0 445 010 279 0 986 437 020</b>
<b>Getz</b>						
1.5 CRDi [TB]	1,5	60	D3-EA <TCI>		05.03-08.05	<b>0 445 010 280 0 986 437 021</b> <b>0 986 437 081</b>
		65	D4FA-L <TDI>		09.05-02.06	<b>0 445 010 289 0 986 437 030</b>
					07.08-06.09	<b>0 445 010 290 0 986 437 042</b>
		81	D4FA <TDI>		09.05-02.06	<b>0 445 010 289 0 986 437 030</b>
					07.08-06.09	<b>0 445 010 290 0 986 437 042</b>
<b>Grandeur</b>						
2.2 CRDi [TG]	2,2	110-114	D4EB		07.06→	<b>0 445 010 342 0 986 437 354</b>
<b>ix20</b>						
1.6 CRDi [JC]	1,6	85/94	D4FB <1.6 U2>		05.11→	<b>0 445 010 290 0 986 437 042</b>
<b>ix35</b>						
1.7 CRDi [LM]	1,7	85	D4FD <1.7L-U>		09.10→	<b>0 445 010 290 0 986 437 042</b>
2.0 CRDi, CRDi 4x4 [LM]	2,0	100/135	D4HA <2.0L-R>		01.10→	<b>0 445 010 544</b>
<b>ix55</b>						
3.0 V6 CRDi 4x4 [EN]	3,0	176	D6EA <3L-S>		04.09→	<b>0 445 010 347</b>
<b>i10</b>						
1.1 CRDi [PA]	1,1	55	D3FA <1.1L-U>		07.08-12.10	<b>0 445 010 290 0 986 437 042</b>
<b>i20</b>						
1.4 CRDi [PB/PBT]	1,4	55/66	D4FC <1.4L-U/1.4L U2>		10.08→ EU4	<b>0 445 010 290 0 986 437 042</b>
1.6 CRDi [PB/PBT]	1,6	85/94	D4FB <1.6L-U2>		01.09→	<b>0 445 010 290 0 986 437 042</b>
<b>i30</b>						
1.6 CRDi [FD/FDH]	1,6	66/85	D4FB <1.6L-U/1.6L-U2 D TCI>		09.07→ TW	<b>0 445 010 290 0 986 437 042</b>
		94	D4FB <1.6L-U2 DOHC TCI>		11.08→	<b>0 445 010 290 0 986 437 042</b>
2.0 CRDi [FD/FDH]	2,0	100-103	D4EA <2.0L-D SOHC TCI>		09.07→	<b>0 445 010 342 0 986 437 354</b>





◀ HYUNDAI

<b>i30 CW</b>									
1.6 CRDi [FD/FDH]	1,6	66/85	D4FB <1.6L-U/1.6L-U2 D TCI>	02.08→	TW	0 445 010 290	0 986 437 042		
		94	D4FB <1.6L-U2 DOHC TCI>	11.08→		0 445 010 290	0 986 437 042		
2.0 CRDi [FD/FDH]	2,0	100-103	D4EA <2.0L-D SOHC TCI>	03.08→		0 445 010 342	0 986 437 354		
<b>i40</b>									
1.7 CRDi [VF]	1,7	85/100	D4FD <1.7L-U>	04.11→		0 445 010 290	0 986 437 042		
<b>i40 CW</b>									
1.7 CRDi [VF]	1,7	85/100	D4FD <1.7L-U>	04.11→		0 445 010 290	0 986 437 042		
<b>Matrix</b>									
1.5 CRDi [FC]	1,5	60	D3-EA <TCI>	07.01-01.06		0 445 010 280	0 986 437 021		
		75	D4FA <TDI>	02.05-08.06		0 445 010 355			
		81	D4FA-G <TDI>	07.08-04.10		0 445 010 290	0 986 437 042		
<b>Santa Fe</b>									
2.0 CRDi	2,0	83	<DOHC>	06.00-08.03		0 445 010 279	0 986 437 020		
CRDi, CRDi 4x4 [CM]	2,0	110	D4HA <2L-R>	09.10→		0 445 010 544			
CRDi, CRDi 4x4 [SM]	2,0	83	D4EA	01.01-12.05		0 445 010 279	0 986 437 020		
CRDi-VGT	2,0	83	D4EA	08.03→		0 445 010 281	0 986 437 022		
CRDi-VGT 4x4 [SM]	2,0	92	D4EA-V	08.03-12.05		0 445 010 281	0 986 437 022		
2.2 CRDi, CRDi 4x4 [CM]	2,2	110-114	D4EB <2.2L-D>	03.06-11.09		0 445 010 342	0 986 437 354		
		145	D4HB <2.2L-R>	11.09→		0 445 010 544			
<b>Santa Fe New</b>									
2.2 VGT CRDi	2,2	153	HTI	11.05→		0 445 010 342	0 986 437 354		
<b>Solaris</b>									
1.6 CRDi [RB]	1,6	94	D4BF	01.11→		0 445 010 290	0 986 437 042		
<b>Sonata</b>									
2.0 CRDi [NF]	2,0	100-103/110	D4EA <2L-D TCI SOHC>	01.06-12.10		0 445 010 342	0 986 437 354		
<b>Trajet</b>									
2.0 CRDi [FO]	2,0	83	D4EA	01.01-06.07		0 445 010 279	0 986 437 020		
<b>Trajet XG</b>									
2.0 VGT CRDi	2,0	93	D	01.03→		0 445 010 079	0 986 437 022		
<b>Tucson</b>									
2.0 CRDi, CRDi 4x4 [JM]	2,0	83	D4EA	08.04-12.06	N25	0 445 010 279	0 986 437 020		
					N25	0 445 010 342	0 986 437 354		
		103	D4EA...	09.05-10.08	N25	0 445 010 279	0 986 437 020		
					N25	0 445 010 342	0 986 437 354		
		110	D4EA	01.09-03.10	N25	0 445 010 279	0 986 437 020		
					N25	0 445 010 342	0 986 437 354		
VGT CRDi	2,0	115		12.05→		0 445 010 342	0 986 437 354		

**IVECO**

<b>Massif</b>									
3.0	3,0	107/130	F1CE0481F*...; F1CE0481H*...	06.08→		0 445 020 046			

**JAGUAR**

<b>XF</b>									
3.0 D, V6 SD	3,0	155/177/202	AJV6D	03.09→		0 445 010 662			
<b>XJ</b>									
3.0 D V6	3,0	202		08.10→		0 445 010 662			

**JEEP**

<b>Liberty</b>									
2.8 CRD 4x4 [KJ]	2,8	112-120	ENR	08.05-08.06		0 445 010 104			



## KIA

Carens							
2.0 CRDi, CRDi VGT [FG]	2,0	85/100/103	D4EA; D4EA-L; D4EA-W		09.06→	0 445 010 342	0 986 437 354
Carens New							
2.0 VGT CRDi	2,0	146			04.06→	0 445 010 342	0 986 437 354
Carnival							
2.2 CRDi [MB]	2,2	110/143	D4HB <2.2L-R>		10.09→	0 445 010 544	
Cee'd							
1.6 CRDi [ED/FF2]	1,6	66/85/94	D4FB; D4FB-L		02.09→	0 445 010 290	0 986 437 042
2.0 CRDi [ED/FF2]	2,0	103	D4EA-F		09.07→	0 445 010 342	0 986 437 354
Cee'd Sporty Wagon							
1.6 CRDi [ED/FF2]	1,6	66/85/94	D4FB; D4FB-L		02.09→	0 445 010 290	0 986 437 042
2.0 CRDi [ED/FF2]	2,0	103	D4EA-F		09.07→	0 445 010 342	0 986 437 354
Cerato							
1.6 CRDi [FE]	1,6	85	D4FB		07.08-11.09	0 445 010 290	0 986 437 042
Cerato Hatchback							
1.6 CRDi [FE]	1,6	85	D4FB		07.08-11.09	0 445 010 290	0 986 437 042
Magentis							
2.0 CRDi [GE]	2,0	103/110	D4EA		02.06→	0 445 010 342	0 986 437 354
Mohave							
3.0 CRDi	3,0	184	<3.0 S>		01.09→	0 445 010 347	
Optima							
1.7 CRDi [TF]	1,7	100-103	D4FD		09.11→	0 445 010 290	0 986 437 042
Picanto							
1.1 CRDi [BA]	1,1	55	D3FA		11.05→ TW	0 445 010 290	0 986 437 042
Pro Cee'd							
1.6 CRDi [ED]	1,6	66/85/94	D4FB; D4FB-FL		02.09→	0 445 010 290	0 986 437 042
2.0 CRDi [ED]	2,0	103	D4EA		03.08→	0 445 010 342	0 986 437 354
Rio							
1.5 CRDi [DE]	1,5	81	D4FA		03.05→ TW	0 445 010 290	0 986 437 042
Rio Hatchback							
1.5 CRDi [DE]	1,5	65/81	D4FA		03.05-09.11 TW	0 445 010 290	0 986 437 042
Sorento							
2.0 CRDi, CRDi 4x4 [XM]	2,0	110	D4HA		10.10→	0 445 010 544	
2.2 CRDi, CRDi 4x4 [XM]	2,2	145	D4HB		09.09→	0 445 010 544	
2.5 CRDi [JC]	2,5	103	D4CB		07.02-12.03	0 445 010 354	
Soul							
1.6 CRDi [AM]	1,6	85/94	D4FB <Euro 4>		01.09→	0 445 010 290	0 986 437 042
Sportage							
1.7 CRDi [SL]	1,7	85	D4FD		09.10→	0 445 010 290	0 986 437 042
2.0 CRDi, CRDi 4x4 [JE]	2,0	100-103	D4EA...; D4EA-V		01.06-07.08	0 445 010 342	0 986 437 354
		110	D4EA		08.08-05.10 EU4	0 445 010 342	0 986 437 354
CRDi, CRDi 4x4 [SL]	2,0	100/135	D4HA		07.10→	0 445 010 544	
Venga							
1.6 CRDi	1,6	85/94	D4FB <1600 U2>		12.09→	0 445 010 290	0 986 437 042

## LANCIA

Delta							
1.6 JTD [844]	1,6	88	198 A 2.000 <M78>		07.08→	0 445 010 185	
1.9 JTD [844]	1,9	140	844 A 1.000 <M94>		08.08→	0 445 010 166	
2.0 MJTD [844]	2,0	121	198 A 5.000 <M120>		08.08→	0 445 010 185	
Kappa Berlina							
2.4 JTD [838]	2,4	100	838A8.000 <M3>		03.98-12.00	0 445 010 006	0 986 437 001
Kappa Station Wagon							
2.4 JTD [838]	2,4	100	838A8.000 <M3>		03.98-12.00	0 445 010 006	0 986 437 001
Lybra Berlina							
1.9 JTD [839]	1,9	77/80/85	AR32302 <M1 CF2>; AR37101 <M2 CF3>; 937A2.000 <M3 CF3>		10.99-11.06	0 445 010 007	0 986 437 002



◀ LANCIA

2.4 JTD [839]	2,4	98/103/110	839A5.000/AR32501 <M6/M5 CF2>; 839A6.000 <M7 CF3>; 841C000 <M8 CF3>	10.99-09.05		0 445 010 006	0 986 437 001
<b>Lybra Station Wagon</b>							
1.9 JTD [839]	1,9	77/80/85	AR32302 <M1 CF2>; AR37101 <M2 CF3>; 937A2.000 <M3 CF3>	10.99-11.06		0 445 010 007	0 986 437 002
2.4 JTD [839]	2,4	98/103/110	839A5.000/AR32501 <M6/M5 CF2>; 839A6.000 <M7 CF3>; 841C000 <M8 CF3>	10.99-09.05		0 445 010 006	0 986 437 001
<b>Musa</b>							
1.3 MJTD [184]	1,3	51	188A9000 <M30>	10.04→		0 445 010 276	0 986 437 023
MJTD 16V [184]	1,3	66	199A3000 <M72>				
			Mot.Nr. MOT1438789→	10.06→		0 445 010 293	0 986 437 036
			Mot.Nr. →MOT1438788	01.06-09.06		0 445 010 286	0 986 437 035
		70	199B1000	02.10→		0 445 010 310	0 986 437 038
1.6 JTD [184]	1,6	85/88	350A2000 <M78>; 350A3000 <M77>	10.07→		0 445 010 185	
1.9 JTD [184]	1,9	74	188B2000 <M40>	10.04→		0 445 010 071	
<b>Phedra</b>							
2.0 JTD 16V [180]	2,0	80	RHM <M7>; RHW <M5>	09.02-03.06		0 445 010 021	0 986 437 012
2.2 JTD 16V [180]	2,2	95	4HW <M10>	09.02-09.07		0 445 010 021	0 986 437 012
		125	4HT <M11>; 4H01 <M12/M13>	10.07-12.10		0 445 010 139	0 986 437 034
<b>Thesis</b>							
2.4 JTD 10V [841]	2,4	110	841C.000 <M20>	04.02-02.05		0 445 010 006	0 986 437 001
JTD 20V [841]	2,4	120/129	841G.000 <M24>; 841H.000 <M25>; 841M.000 <M22>; 841N.000 <M23>	06.03-02.06		0 445 010 072	
		136	841P.000 <M99 CF4>	03.06-12.09		0 445 010 123	
<b>Ypsilon</b>							
1.3 JTD 16V, Multijet 16V [843]	1,3	51/55	188A9000 <M15>; 199A2000 <M73>	06.03→		0 445 010 276	0 986 437 023
Multijet 16V [843]	1,3	55/66/77	199A2000 <M75>; 199A3000 <M72>; 199A3000 <M105>	10.06→		0 445 010 293	0 986 437 036
Multijet 16V [846]	1,3	70	199B1000	06.11→		0 445 010 310	0 986 437 038
<b>ZETA</b>							
2.0 JTD [122]	2,0	80	RHW <M11>	10.00-06.02		0 445 010 021	0 986 437 012

**LAND ROVER GROUP**

<b>Discovery IV</b>							
3.0 TDV6	3,0	180-188	306DT	09.09→		0 445 010 662	
<b>Freelander</b>							
2.0 TD4 [LN]	2,0	80-82	204D3/TD4	09.01-03.07		0 445 010 011	0 986 437 006
<b>Freelander II</b>							
2.2 Td4	2,2	110-118	224DT	10.06→		0 445 010 367	0 986 437 034
<b>Range Rover Evoque</b>							
2.2 SD4, TD4	2,2	110/140		09.11→		0 445 010 298	
<b>Range Rover III</b>							
3.0 Td6	2,9	130	M57 D30	03.02-09.06		0 445 010 009	0 986 437 004
<b>Range Rover Sport II</b>							
3.0 TDV6	3,0	155-188	306DT	09.09→		0 445 010 662	

**MAZDA**

<b>BT-50</b>							
2.5 D Turbo [UN]	2,5	105	WL3 <DuraTORQ TDCi>	03.06→	TW	0 445 010 213	
D Turbo, D Turbo 4x4 [UN]	2,5	105	WLC <DuraTORQ TDCi>	03.06-01.07		0 445 010 107	
				02.08→		0 445 010 213	
3.0 D Turbo [UN]	3,0	115	WEC <DuraTORQ TDCi>	03.06-07.08	TW	0 445 010 107	
				03.06→	TW	0 445 010 213	
D Turbo 4x4 [UN]	3,0	115	WEC <DuraTORQ TDCi>	03.06-01.07		0 445 010 107	
				02.08→		0 445 010 213	
<b>2</b>							
1.6 CD [DE]	1,6	66	Y6				
			Fg.Nr. →DEA4**400000 →DEA3**300000	11.08-07.10		0 445 010 296	0 986 437 028





<b>3</b>									
1.6 MZ-CD [BK]	1,6	80	Y6		12.03-12.08	TW		0 445 010 089	0 986 437 322
								0 445 010 296	0 986 437 028
MZR-CD [BL]	1,6	80-81	Y6		12.08→			0 445 010 296	0 986 437 028
<b>3 Hatchback</b>									
1.6 MZ-CD [BK]	1,6	66/80	Y6		12.03-12.08	TW		0 445 010 089	0 986 437 322
								0 445 010 296	0 986 437 028
MZR-CD [BL]	1,6	80-81	Y6		12.08→			0 445 010 296	0 986 437 028

**MERCEDES-BENZ**

<b>Serie A</b>									
160 CDI [168]	1,7	44/55	OM 668.940 <DE 17 LA>; OM 668.941 <DE 17 A>		09.98-08.04			0 445 010 268	0 986 437 100
CDI [169]	2,0	60	OM 640.942 <DE 20 LA>		09.04→	WAS		0 445 010 341	0 986 437 368
						WAS		0 445 010 352	
170 CDI [168]	1,7	66/70	OM 668.940 <DE 17 LA>; OM 668.942 <DE 17 LA>		07.98-08.04			0 445 010 268	0 986 437 100
180 CDI [169]	2,0	80	OM 640.940 <DE 20 LA>		09.04→	WAS		0 445 010 341	0 986 437 368
						WAS		0 445 010 352	
200 CDI [169]	2,0	103	OM 640.941 <DE 20 LA>		09.04→	WAS		0 445 010 341	0 986 437 368
						WAS		0 445 010 352	
<b>Serie B</b>									
180 CDI [245]	2,0	80	OM 640.940 <DE 20 LA>		04.05→	WAS		0 445 010 341	0 986 437 368
						WAS		0 445 010 352	
200 CDI [245]	2,0	103	OM 640.941 <DE 20 LA>		04.05→	WAS		0 445 010 341	0 986 437 368
						WAS		0 445 010 352	
<b>Serie C</b>									
30 AMG CDI [203]	3,0	170	OM 612.990 <DE 30 LA AMG>		01.03-08.04			0 445 010 334	0 986 437 360
200 CDI [202]	2,2	75	OM 611.960 <DE LA>		03.98-04.00	RAP		0 445 010 268	0 986 437 100
						RAP		0 445 010 274	0 986 437 105
CDI [203]	2,2	85	OM 611.962 <DE LA>		10.00-02.03	RAP		0 445 010 268	0 986 437 100
						RAP		0 445 010 274	0 986 437 105
220 CDI [202]	2,2	92	OM 611.960 <DE LA>		12.97-04.00	RAP		0 445 010 268	0 986 437 100
						RAP		0 445 010 274	0 986 437 105
CDI [203]	2,2	100-105	OM 611.962 <DE LA>		05.00-02.03	RAP		0 445 010 268	0 986 437 100
						RAP		0 445 010 274	0 986 437 105
270 CDI [203]	2,7	125	OM 612.962 <DE LA>		12.00-08.04			0 445 010 271	0 986 437 104
320 CDI [203]	3,0	165	OM 642.910 <D 30>		09.04-05.07			0 445 010 356	0 986 437 365
CDI 4MATIC [204]	3,0	165	OM 642.961 <D 30>		07.07-04.09	WAS		0 445 010 356	0 986 437 365
350 CDI [204]	3,0	195	OM 642.834		02.11→	SSJ		0 445 010 362	
						SSJ		0 445 010 361	
CDI, CDI 4MATIC [204]	3,0	170	OM 642.830 <D 30 LHD>; OM 642.832 <D 30 LHD>		10.09→			0 445 010 362	
CDI 4MATIC [204]	3,0	165	OM 642.961 <D 30>		05.09-09.09	WAS		0 445 010 356	0 986 437 365
<b>Serie C (Sportcoupe)</b>									
30 AMG CDI [203]	3,0	170	OM 612.990 <DE 30 LA AMG>		09.02-08.04			0 445 010 334	0 986 437 360
200 CDI [203]	2,2	90	OM 646.962 <DE 22 LA>						
			Mot.Nr. 30478283→		03.03-02.08			0 445 010 346	0 986 437 364
220 CDI [203]	2,2	105	OM 611.962 <DE LA>		01.01-02.03	RAP		0 445 010 268	0 986 437 100
						RAP		0 445 010 274	0 986 437 105
		110	OM 646.963 <DE 22 LA>						
			Mot.Nr. 30478283→		03.03-02.08			0 445 010 346	0 986 437 364
<b>Serie C (T-Modell)</b>									
30 AMG CDI [203]	3,0	170	OM 612.990 <DE 30 LA AMG>		01.03-08.04			0 445 010 334	0 986 437 360
200 CDI [202]	2,2	75	OM 611.960 <DE LA>		03.98-02.01	RAP		0 445 010 268	0 986 437 100
						RAP		0 445 010 274	0 986 437 105
CDI [203]	2,2	85	OM 611.962 <DE LA>		10.01-02.03	RAP		0 445 010 268	0 986 437 100
						RAP		0 445 010 274	0 986 437 105
220 CDI [202]	2,2	92	OM 611.960 <DE LA>		12.97-02.01	RAP		0 445 010 268	0 986 437 100
						RAP		0 445 010 274	0 986 437 105
CDI [203]	2,2	105	OM 611.962 <DE LA>		01.01-02.03	RAP		0 445 010 268	0 986 437 100
						RAP		0 445 010 274	0 986 437 105
270 CDI [203]	2,7	125	OM 612.962 <DE LA>		01.01-08.04			0 445 010 271	0 986 437 104





◀ MERCEDES-BENZ

320 CDI [203]	3,0	165	OM 642.910 <D 30>	09.04-08.07	WAS	0 445 010 356	0 986 437 365
					WAS	0 445 010 345	0 986 437 363
CDI 4MATIC [204]	3,0	165	OM 642.961 <D 30>	09.07-04.09	WAS	0 445 010 356	0 986 437 365
					WAS	0 445 010 345	0 986 437 363
350 CDI [204]	3,0	195	OM 642.834	02.11→	SSJ	0 445 010 362	
					SSJ	0 445 010 361	
CDI, CDI 4MATIC [204]	3,0	170	OM 642.830 <D 30 LHD REPO>; OM 642.832 <D 30 LHD REPO>	10.09→		0 445 010 362	
<b>Serie CLC</b>							
200 CDI [203]	2,2	90	OM 646.962 <DE 22 LA>	03.08-05.10		0 445 010 346	0 986 437 364
220 CDI [203]	2,2	110	OM 646.963 <DE 22 LA>	03.08-05.10		0 445 010 346	0 986 437 364
<b>Serie CLK (Cabrio)</b>							
320 CDI [209]	3,0	165	OM 642.910 <D 30>	04.05-12.09	WAS	0 445 010 356	0 986 437 365
					WAS	0 445 010 345	0 986 437 363
<b>Serie CLK (Coupé)</b>							
220 CDI [209]	2,1	110	OM 646.966 <DE 22 LA> Mot.Nr. 30478283→	04.05-04.09		0 445 010 346	0 986 437 364
270 CDI [209]	2,7	125	OM 612.962; 967 <DE LA>	09.02-03.05		0 445 010 271	0 986 437 104
320 CDI [209]	3,0	165	OM 642.910 <D 30>	04.05-04.09		0 445 010 356	0 986 437 365
<b>Serie CLS</b>							
320 CDI [219]	3,0	165	OM 642.920 <D 30>	05.05-04.09	WAS	0 445 010 356	0 986 437 365
					WAS	0 445 010 345	0 986 437 363
350 CDI [219]	3,0	165	OM 642.920 <D 30>	05.09-09.09	WAS	0 445 010 356	0 986 437 365
					WAS	0 445 010 345	0 986 437 363
CDI, CDI 4MATIC [218]	3,0	195	OM 642.853 <D 30 LHD>; OM 642.854 <D 30 LHD REPO GEST>	10.10→	SSJ	0 445 010 362	
					SSJ	0 445 010 361	
<b>Serie E</b>							
200 CDI [210]	2,1	85	OM 611.961 <DE LA>	07.99-03.02	RAP	0 445 010 268	0 986 437 100
					RAP	0 445 010 274	0 986 437 105
	2,2	75	OM 611.961 <DE LA>	07.98-03.02	RAP	0 445 010 268	0 986 437 100
					RAP	0 445 010 274	0 986 437 105
CDI [211]	2,1	75/90	OM 646.951 <DE 22 LA> Mot.Nr. 30478283→	07.02-09.08		0 445 010 346	0 986 437 364
220 CDI [210]	2,1	100-105	OM 611.961 <DE LA>	07.99-03.02	RAP	0 445 010 268	0 986 437 100
					RAP	0 445 010 274	0 986 437 105
	2,2	92	OM 611.961 <DE LA>	07.98-05.99	RAP	0 445 010 268	0 986 437 100
					RAP	0 445 010 274	0 986 437 105
CDI [211]	2,1	100/110	OM 646.961 <DE 22 LA> Mot.Nr. 30478283→	03.02-01.09		0 445 010 346	0 986 437 364
270 CDI [210]	2,7	125	OM 612.961 <DE LA>	06.99-03.02		0 445 010 271	0 986 437 104
CDI [211]	2,7	130	OM 647.961 <DE 27 LA>	03.02-03.05		0 445 010 346	0 986 437 364
280 CDI [211]	3,2	130	OM 648.961 <DE 32 LA>	04.04-03.05		0 445 010 346	0 986 437 364
CDI, CDI 4MATIC [211]	3,0	140	OM 642.920 <D 30>; OM 642.921 <D 30>	04.05-03.09		0 445 010 356	0 986 437 365
300 CDI [212]	3,0	150/170	OM 642.850 <D 30 LHD REPO>	12.09→	SCJ, WAS	0 445 010 362	
					SCJ, WAS	0 445 010 363	
					SCJ	0 445 010 356	0 986 437 365
		170	OM 642.852 <D 30 LHD REPO.GEST.>	08.11→	SSJ	0 445 010 362	
					SSJ	0 445 010 361	
320 CDI [210]	3,2	145	OM 613.961 <DE LA>	06.99-03.02		0 445 010 270	0 986 437 102
CDI [211]	3,2	150	OM 648.961 <DE 32 LA>	11.02-08.06		0 445 010 346	0 986 437 364
CDI, CDI 4MATIC [211]	3,0	165	OM 642.920 <D 30>; OM 642.921 <D 30>	04.05-03.09		0 445 010 356	0 986 437 365
350 BlueTec [212]	3,0	155	OM 642.850 <D 30>	04.09→		0 445 010 356	0 986 437 365
CDI [212]	3,0	195	OM 642.852 <D 30 LL>	12.10→	SSJ	0 445 010 362	
					SSJ	0 445 010 361	
CDI, CDI 4MATIC [212]	3,0	170	OM 642.850 <D 30 LL>; OM 642.856 <D 30>	08.08-11.10	WAS	0 445 010 362	
					WAS	0 445 010 360	
CDI 4MATIC [212]	3,0	195	OM 642.858 <D 30 LHD REP GEST>	12.10→	SSJ	0 445 010 362	
					SSJ	0 445 010 361	
400 CDI [211]	4,0	191	OM 628.961 <DE 40 LA>	02.03-04.05		0 445 010 334	0 986 437 360
420 CDI [211]	4,0	231	OM 629.910 <DE 40 LL>	09.05-01.09		0 445 010 339	0 986 437 367





<b>Serie E (Cabrio)</b>									
350 CDI [207]	3,0	170	OM 642.836 <D 30 LHD REPO>	01.10-01.11					<b>0 445 010 362</b>
		195	OM 642.838 <D 30 LHD REPO.GEST.>	04.11→	SSJ			<b>0 445 010 362</b>	
								SSJ	<b>0 445 010 361</b>
<b>Serie E (Coupé)</b>									
350 CDI [207]	3,0	170	OM 642.836 <D 30>	02.09-03.11					<b>0 445 010 362</b>
		195	OM 642.838 <D 30 LHD REPO.GEST.>	04.11→	SCJ			<b>0 445 010 362</b>	
								SSJ	<b>0 445 010 361</b>
<b>Serie E (T-Modell)</b>									
220 CDI [210]	2,1	100-105	OM 611.961 <DE LA>	07.99-01.03	RAP				<b>0 445 010 268 0 986 437 100</b>
					RAP				<b>0 445 010 274 0 986 437 105</b>
	2,2	92	OM 611.961 <DE LA>	07.98-05.99	RAP				<b>0 445 010 268 0 986 437 100</b>
					RAP				<b>0 445 010 274 0 986 437 105</b>
CDI [211]	2,1	100/110	OM 646.961 <DE 22 LA> Mot.Nr. 30478283→	02.03-08.09					<b>0 445 010 346 0 986 437 364</b>
270 CDI [210]	2,7	125	OM 612.961 <DE LA>	06.99-01.03					<b>0 445 010 271 0 986 437 104</b>
CDI [211]	2,7	130	OM 647.961 <DE 27 LA>	02.03-03.05					<b>0 445 010 346 0 986 437 364</b>
280 CDI [211]	3,2	130	OM 648.961 <DE 32 LA>	04.04-03.05					<b>0 445 010 346 0 986 437 364</b>
CDI, CDI 4MATIC [211]	3,0	140	OM 642.920 <D 30>; OM 642.921 <D 30>	04.05-08.09					<b>0 445 010 356 0 986 437 365</b>
300 CDI [212]	3,0	150	OM 642.850 <D 30 LHD REPO>	12.09-12.10					<b>0 445 010 362</b>
		170	OM 642.850 <D 30 LHD REPO>	01.11→	SCJ,WAS			<b>0 445 010 362</b>	
					SCJ,WAS			<b>0 445 010 363</b>	
					SCJ			<b>0 445 010 356 0 986 437 365</b>	
			OM 642.852 <D 30 LHD REPO.GEST.>	08.11→	SSJ			<b>0 445 010 362</b>	
					SSJ			<b>0 445 010 361</b>	
320 CDI [210]	3,2	145	OM 613.961 <DE LA>	07.99-01.03					<b>0 445 010 270 0 986 437 102</b>
CDI [211]	3,2	150	OM 648.961 <DE 32 LA>	02.03-03.05					<b>0 445 010 346 0 986 437 364</b>
CDI, CDI 4MATIC [211]	3,0	165	OM 642.920 <D 30>; OM 642.921 <D 30>	04.05-08.09					<b>0 445 010 356 0 986 437 365</b>
350 BlueTec [212]	3,0	155	OM 642.850 <D 30 LHD REPO>	08.09→					<b>0 445 010 345 0 986 437 363</b>
CDI [212]	3,0	170	OM 642.850 <D 30 LHD REPO>	08.09-11.10	WAS				<b>0 445 010 362</b>
					WAS				<b>0 445 010 360</b>
CDI, CDI 4MATIC [212]	3,0	195	OM 642.852 <D 30 LHD REPO GEST>; OM 642.858 <D 30 LHD REPO>	12.10→					<b>0 445 010 362</b>
CDI 4MATIC [212]	3,0	170	OM 642.856 <D 30 LHD REPO>	08.09-11.10	WAS				<b>0 445 010 362</b>
					WAS				<b>0 445 010 360</b>
<b>Serie G</b>									
270 CDI [463]	2,7	115	OM 612.965 <DE LA>	10.01-08.06					<b>0 445 010 271 0 986 437 104</b>
320 CDI [463]	3,0	165	OM 642.970	09.06→					<b>0 445 010 345 0 986 437 363</b>
350 BlueTEC [463]	3,0	155	OM 642...; OM 642.886	07.11→					<b>0 445 010 345 0 986 437 363</b>
400 CDI [463]	4,0	184	OM 628.962 <DE40LARL>	12.00-08.06					<b>0 445 010 334 0 986 437 360</b>
<b>Serie GL</b>									
320 CDI 4MATIC [164]	3,0	165	OM 642.820 <D 30 LHD REPO>	09.08→	SCJ				<b>0 445 010 362</b>
					SCJ,WAS			<b>0 445 010 345 0 986 437 363</b>	
					SCJ,WAS				<b>0 445 010 360</b>
			OM 642.940 <D 30>	02.06-04.09	WAS				<b>0 445 010 356 0 986 437 365</b>
					WAS				<b>0 445 010 345 0 986 437 363</b>
350 BlueTec 4MATIC [164]	3,0	155	OM 642.820 <D 30 LHD REPO>	04.09→	WAS				<b>0 445 010 345 0 986 437 363</b>
					WAS				<b>0 445 010 360</b>
CDI 4MATIC [164]	3,0	165	OM 642.940 <D 30>	05.09-08.10	WAS				<b>0 445 010 356 0 986 437 365</b>
					WAS				<b>0 445 010 345 0 986 437 363</b>
		195	OM 642.822 <D 30 LHD REPO>	09.10→	SCJ				<b>0 445 010 362</b>
					SCJ				<b>0 445 010 356 0 986 437 365</b>
420 CDI 4MATIC [164]	4,0	225	OM 629.912 <DE 30 LA>	02.06-04.09					<b>0 445 010 339 0 986 437 367</b>
450 CDI 4MATIC [164]	4,0	225	OM 629.912 <DE 30 LA>	05.09→					<b>0 445 010 339 0 986 437 367</b>
<b>Serie GLK</b>									
320 CDI 4MATIC [204]	3,0	165	OM 642.961 <D 30>	09.08→	WAS				<b>0 445 010 356 0 986 437 365</b>
					WAS				<b>0 445 010 345 0 986 437 363</b>
350 CDI 4MATIC [204]	3,0	165-170	OM 642.832 <D 30 LHD REPO>	04.09→					<b>0 445 010 362</b>
<b>Serie ML</b>									
270 CDI [163]	2,7	120	OM 612.963 <DE LA>	11.99-06.05					<b>0 445 010 271 0 986 437 104</b>
280 CDI 4MATIC [164]	3,0	140	OM 642.940 <D 30>	07.05-04.09	WAS				<b>0 445 010 356 0 986 437 365</b>
					WAS				<b>0 445 010 345 0 986 437 363</b>





◀ MERCEDES-BENZ

300 CDI 4MATIC [164]	3,0	140	OM 642.940 <D 30>	05.09-12.10	WAS	0 445 010 356	0 986 437 365
					WAS	0 445 010 345	0 986 437 363
		150	OM 642.820 <D 30 LHD REPO>	05.09→	SCJ,TW	0 445 010 362	
			Komp.Nr. 801	05.09→	SCJ,TW	0 445 010 356	0 986 437 365
					TW,WAS	0 445 010 363	
320 CDI 4MATIC [164]	3,0	165	OM 642.940 <D 30>	03.05-04.09		0 445 010 356	0 986 437 365
350 BlueTec 4MATIC [166]	3,0	190	OM 642.826 <D 30 LHD REPO GEST>	06.11→	SSJ,WAS	0 445 010 362	
					SSJ,WAS	0 445 010 363	
					SSJ,WAS	0 445 010 361	
					SSJ,WAS	0 445 010 322	
BlueTec 4MATIC, CDI 4MATIC [164]	3,0	155/165	OM 642.820 <D 30 LHD REPO>; OM 642.940 <D 30>	05.09→		0 445 010 356	0 986 437 365
CDI 4MATIC [164]	3,0	170	OM 642.820 <D 30>	02.10→	SCJ,WAS	0 445 010 362	
					SCJ,WAS	0 445 010 363	
					SCJ	0 445 010 356	0 986 437 365
400 CDI [163]	4,0	184	OM 628.963 <DE 40 LA LL>	09.01-06.05		0 445 010 334	0 986 437 360
420 CDI 4MATIC [164]	4,0	225	OM 629.912 <DE 40 LA>	02.06-04.09		0 445 010 339	0 986 437 367
450 CDI 4MATIC [164]	4,0	225	OM 629.912 <DE 40 LA>	05.09→		0 445 010 339	0 986 437 367
<b>Serie R</b>							
280 CDI, CDI 4MATIC [251]	3,0	140	OM 642.950 <D 30>	04.06-04.09	WAS	0 445 010 356	0 986 437 365
					WAS	0 445 010 345	0 986 437 363
300 CDI [251]	3,0	140	OM 642.87... <D 30>	05.10→		0 445 010 362	
CDI, CDI 4MATIC [251]	3,0	140	OM 642.950 <D 30>	05.09-05.10	WAS	0 445 010 356	0 986 437 365
					WAS	0 445 010 345	0 986 437 363
320 CDI 4MATIC [251]	3,0	165	OM 642.950 <D 30>	09.05-04.09		0 445 010 356	0 986 437 365
				06.07-05.09	WAS	0 445 010 356	0 986 437 365
					WAS	0 445 010 345	0 986 437 363
350 BlueTec 4MATIC [251]	3,0	155	OM 642.870 <D 30 LHD REPO>	05.09→		0 445 010 345	0 986 437 363
CDI 4MATIC [251]	3,0	195	OM 642.872 <D 30>	05.10→		0 445 010 362	
<b>Serie S</b>							
320 CDI [220]	3,2	145	OM 613.960 <DE 32 LA>	06.99-08.02		0 445 010 270	0 986 437 102
CDI, CDI 4MATIC [221]	3,0	173	OM 642.930 <D 30>	12.05-04.09	WAS	0 445 010 356	0 986 437 365
					WAS	0 445 010 345	0 986 437 363
350 BlueTEC, BlueTEC 4MATIC [221]	3,0	190	OM 642.862 <D 30 LHD>; OM 642.868 <D 30 LHD>	07.10→		0 445 010 362	
CDI [221]	3,0	173	OM 642.930 <D 30>	05.09-06.10	WAS	0 445 010 356	0 986 437 365
					WAS	0 445 010 345	0 986 437 363
CDI 4MATIC [221]	3,0	173	OM 642.932 <D 30>	05.09-06.10	WAS	0 445 010 356	0 986 437 365
					WAS	0 445 010 345	0 986 437 363
400 CDI [220]	4,0	184/191	OM 628.960 <DE 40 LA>	06.99-08.05		0 445 010 334	0 986 437 360
420 CDI [221]	4,0	235	OM 629.911 <DE 40 LA>	12.06-04.09		0 445 010 339	0 986 437 367
450 CDI [221]	4,0	235	OM 629.911 <DE 40 LA>	05.09-06.10		0 445 010 339	0 986 437 367
<b>Serie V</b>							
200 CDI [638 TON]	2,2	75	OM 611.980	06.99-09.03		0 445 010 269	0 986 437 101
220 CDI [638 TON]	2,2	90	OM 611.980	06.99-09.03		0 445 010 269	0 986 437 101
<b>Vaneo</b>							
1.7 CDI [414]	1,7	55/67	OM 668.914 <DE 17 LA>	02.02-08.05		0 445 010 268	0 986 437 100
<b>Viano</b>							
2.0 CDI [639 TON]	2,1	80/85	OM 646.981 <OM 646 DE22LA>; OM 646.982 <OM 646 DE22LA (MOC2)>				
			Mot.Nr. ...50 178027→	09.03-08.10		0 445 010 346	0 986 437 364
2.2 CDI [639 TON]	2,1	110	OM 646.982 <OM 646 DE22LA>				
			Mot.Nr. ...50 178027→	09.03-08.10		0 445 010 346	0 986 437 364
3.0 CDI [639 TON]	3,0	150/165	OM 642.990 <OM 642 DE 30LA>	04.06→	WAS	0 445 010 356	0 986 437 365
					WAS	0 445 010 345	0 986 437 363





**MG**

<b>ZT</b>							
<b>135</b> 2.0 CDTi	2,0	96	20 4D 2 <M47R>		10.02-05.05	<b>0 445 010 011</b>	<b>0 986 437 006</b>
<b>190</b> 2.0 CDT	2,0	85	20 4D 2 <M47R>		10.01-05.05	<b>0 445 010 011</b>	<b>0 986 437 006</b>
<b>ZT-Tourer</b>							
<b>135</b> 2.0 CDTi	2,0	96	20 4D 2 <M47R>		10.02-05.05	<b>0 445 010 011</b>	<b>0 986 437 006</b>
<b>190</b> 2.0 CDT	2,0	85	20 4D 2 <M47R>		10.01-05.05	<b>0 445 010 011</b>	<b>0 986 437 006</b>

**NISSAN**

<b>Patrol GR</b>							
<b>3.0</b> dCi 4x4 [Y61]	3,0	118	ZD30DDTI		01.07-03.10	<b>0 445 010 136</b>	<b>0 986 437 031</b>
<b>Qashqai</b>							
<b>2.0</b> dCi, dCi 4x4 [J10]	2,0	110	M9R		04.07-10.08	<b>0 445 010 170</b>	<b>0 986 437 037</b>
					11.08→	<b>0 445 010 223</b>	<b>0 986 437 044</b>
<b>Qashqai+2</b>							
<b>2.0</b> dCi, dCi 4x4 [JJ10]	2,0	110	M9R		08.08-10.08	<b>0 445 010 170</b>	<b>0 986 437 037</b>
					11.08→	<b>0 445 010 223</b>	<b>0 986 437 044</b>
<b>X-Trail</b>							
<b>2.0</b> dCi, dCi 4x4 [T31]	2,0	110/127	M9R		04.07-10.08	<b>0 445 010 170</b>	<b>0 986 437 037</b>
					11.08→	<b>0 445 010 223</b>	<b>0 986 437 044</b>

**OPEL**

<b>Agila</b>							
<b>1.3</b> CDTi [A]	1,3	51	Z 13 DT <Turbo>		08.03-02.08	<b>0 445 010 278</b>	<b>0 986 437 201</b>
CDTi [B]	1,2	55	Z 13 DTJ		07.08→	<b>0 445 010 278</b>	<b>0 986 437 201</b>
<b>Antara</b>							
<b>2.0</b> CDTi, CDTi 4x4	2,0	93/110	Z 20 DM <Ecotec>; Z 20 DMH; Z 20 DMH <Ecotec> Fg.Nr. →80169709		05.06→	<b>0 445 010 142</b>	<b>0 986 437 032</b>
<b>Astra</b>							
<b>1.3</b> CDTi [H]	1,3	66	Z 13 DTH <Ecotec>		08.05-03.10	<b>0 445 010 293</b>	<b>0 986 437 036</b>
CDTi [J]	1,2	66-70	A 13 DTE <ecoFLEX>		09.09→ SSJ	<b>0 445 010 293</b>	<b>0 986 437 036</b>
<b>1.7</b> CDTi [G]	1,7	59	Z 17 DTL <Turbo>		03.03-01.04	<b>0 445 010 086</b>	<b>0 986 437 317</b>
CDTi [H]	1,7	59/74	Z 17 DTH <Turbo Ecotec>; Z 17 DTL <Turbo Ecotec>		03.04-03.07	<b>0 445 010 086</b>	<b>0 986 437 317</b>
<b>1.9</b> CDTi [H]	1,9	74/88	Z 19 DT <Turbo Ecotec>; Z 19 DTJ <Turbo Ecotec>; Z 19 DTL <Turbo Ecotec>		04.04-03.10	LLE <b>0 445 010 288</b>	RLE <b>0 986 437 025</b>
		110	Z 19 DTH <Turbo Ecotec>		04.04-03.10	LLE <b>0 445 010 288</b>	RLE <b>0 986 437 025</b>
			Mot.Nr. →17579269		04.04-03.10	RLE <b>0 445 010 287</b>	RLE <b>0 986 437 026</b>
			Mot.Nr. 17579270→		04.04-03.10	RLE <b>0 445 010 371</b>	RLE <b>0 986 437 047</b>
<b>2.0</b> CDTi [J]	2,0	118/121	A 20 DTH <Ecotec>		09.09→ SSJ	<b>0 445 010 371</b>	<b>0 986 437 047</b>
						SSJ <b>0 445 010 382</b>	
<b>Astra Caravan</b>							
<b>1.3</b> CDTi [H]	1,3	66	Z 13 DTH <Ecotec>		08.05-03.10	<b>0 445 010 293</b>	<b>0 986 437 036</b>
<b>1.7</b> CDTi [G]	1,7	59	Z 17 DTL <Turbo>		03.03-06.04	<b>0 445 010 086</b>	<b>0 986 437 317</b>
CDTi [H]	1,7	59/74	Z 17 DTH <Turbo Ecotec>; Z 17 DTL <Turbo Ecotec>		08.04-03.07	<b>0 445 010 086</b>	<b>0 986 437 317</b>
<b>1.9</b> CDTi [H]	1,9	74/88	Z 19 DT <Turbo Ecotec>; Z 19 DTJ <Turbo Ecotec>; Z 19 DTL <Turbo Ecotec>		09.04-07.10	LLE <b>0 445 010 288</b>	RLE <b>0 986 437 025</b>
		110	Z 19 DTH <Turbo Ecotec>		09.04-03.10	LLE <b>0 445 010 288</b>	RLE <b>0 986 437 025</b>
			Mot.Nr. →17579269		09.04-03.10	RLE <b>0 445 010 287</b>	RLE <b>0 986 437 026</b>
			Mot.Nr. 17579270→		09.04-03.10	RLE <b>0 445 010 371</b>	RLE <b>0 986 437 047</b>
<b>Astra GTC</b>							
<b>1.3</b> CDTi [H]	1,3	66	Z 13 DTH <Ecotec>		06.05-02.09	<b>0 445 010 293</b>	<b>0 986 437 036</b>
<b>1.7</b> CDTi [H]	1,7	59/74	Z 17 DTH <Turbo Ecotec>; Z 17 DTL <Turbo Ecotec>		03.05-03.07	<b>0 445 010 086</b>	<b>0 986 437 317</b>
<b>1.9</b> [H]	1,9	74	Z 19 DTL <Turbo Ecotec>		07.05-07.10	LLE <b>0 445 010 288</b>	RLE <b>0 986 437 025</b>
						RLE <b>0 445 010 287</b>	RLE <b>0 986 437 026</b>
		88	Z 19 DT <Turbo Ecotec>		07.05-07.10	LLE <b>0 445 010 288</b>	RLE <b>0 986 437 025</b>
						RLE <b>0 445 010 287</b>	RLE <b>0 986 437 026</b>





◀ OPEL

<b>1.9 CDTI [H]</b>	1,9	88	Z 19 DTJ <Turbo Ecotec>	03.05-03.08	LLE	<b>0 445 010 288</b>	<b>0 986 437 025</b>
					RLE	<b>0 445 010 287</b>	<b>0 986 437 026</b>
		110	Z 19 DTH <Turbo Ecotec>	03.05-09.09	LLE	<b>0 445 010 288</b>	<b>0 986 437 025</b>
			Mot.Nr. →17579269	03.05-09.09	RLE	<b>0 445 010 287</b>	<b>0 986 437 026</b>
			Mot.Nr. 17579270→	03.05-09.09	RLE	<b>0 445 010 371</b>	<b>0 986 437 047</b>
<b>2.0 [J]</b>	2,0	121	A 20 DTH <ecoFlex>	09.11→	SSJ	<b>0 445 010 371</b>	<b>0 986 437 047</b>
					SSJ	<b>0 445 010 382</b>	
<b>Astra Sports Tourer</b>							
<b>1.3 CDTI [J]</b>	1,2	67-70	A 13 DTE <ecoFlex>	09.10→	SSJ	<b>0 445 010 293</b>	<b>0 986 437 036</b>
<b>2.0 CDTI [J]</b>	2,0	118/121	A 20 DTH <Ecotec>	09.10→	SSJ	<b>0 445 010 371</b>	<b>0 986 437 047</b>
					SSJ	<b>0 445 010 382</b>	
<b>Astra TwinTop</b>							
<b>1.9 CDTI [H]</b>	1,9	110	Z 19 DTH <Ecotec>	09.05→	LLE	<b>0 445 010 288</b>	<b>0 986 437 025</b>
			Mot.Nr. →17579269	09.05→	RLE	<b>0 445 010 287</b>	<b>0 986 437 026</b>
			Mot.Nr. 17579270→	09.05→	RLE	<b>0 445 010 371</b>	<b>0 986 437 047</b>
<b>Combo</b>							
<b>1.3 CDTI [Tour]</b>	1,3	51/55	Y 13 DT <Ecotec>; Z 13 DT <Ecotec>; Z 13 DTJ <Ecotec>	09.04→		<b>0 445 010 278</b>	<b>0 986 437 201</b>
<b>Corsa</b>							
<b>1.3 CDTI [C]</b>	1,3	51/55	Y 13 DT <Ecotec>; Z 13 DT <Ecotec>; Z 13 DTJ <Ecotec>	09.03-09.06		<b>0 445 010 278</b>	<b>0 986 437 201</b>
CDTI [D]	1,2	55	A 13 DTC <Ecotec>	01.11→	SSJ	<b>0 445 010 278</b>	<b>0 986 437 201</b>
			Z 13 DTJ <Ecotec>	07.06-02.09		<b>0 445 010 278</b>	<b>0 986 437 201</b>
				07.06→		<b>0 445 010 278</b>	<b>0 986 437 201</b>
			A 13 DTH <Ecotec>	10.06-02.09		<b>0 445 010 293</b>	<b>0 986 437 036</b>
			Z 13 DTH <Ecotec>	07.06→		<b>0 445 010 293</b>	<b>0 986 437 036</b>
			A 13 DTR	10.10→		<b>0 445 010 293</b>	<b>0 986 437 036</b>
			Z 13 DTE	12.09-09.10	SSJ	<b>0 445 010 293</b>	<b>0 986 437 036</b>
<b>Insignia</b>							
<b>2.0 CDTI [68]</b>	2,0	81/96/	A 20 D... <ecoFlex>; A 20 DT... <Ecotec>;	09.08→		<b>0 445 010 371</b>	<b>0 986 437 047</b>
		118	A 20 DTH <ecoFlex>				
CDTI [69]	2,0	81/96/	A 20 D... <ecoFlex>; A 20 DT... <Ecotec>;	09.08→		<b>0 445 010 371</b>	<b>0 986 437 047</b>
		118	A 20 DTH <ecoFlex>				
CDTI, CDTI 4x4 [68]	2,0	140	A 20 DTR <Ecotec>	07.09→		<b>0 445 010 550</b>	
CDTI, CDTI 4x4 [69]	2,0	140	A 20 DTR <Ecotec>	07.09→		<b>0 445 010 550</b>	
CDTI 4x4 [68]	2,0	118	A 20 DTH <Ecotec>	06.10→		<b>0 445 010 371</b>	<b>0 986 437 047</b>
CDTI 4x4 [69]	2,0	118	A 20 DTH <Ecotec>	06.10→		<b>0 445 010 371</b>	<b>0 986 437 047</b>
<b>Insignia Sports Tourer</b>							
<b>2.0 CDTI [35]</b>	2,0	81/96/	A 20 D... <ecoFlex>; A 20 DT... <Ecotec>;	02.09→		<b>0 445 010 371</b>	<b>0 986 437 047</b>
		118	A 20 DTH <ecoFlex>				
			A 20 DTR <Ecotec>		07.09→		
CDTI 4x4 [35]	2,0	118	A 20 DTH <Ecotec>	06.10→		<b>0 445 010 371</b>	<b>0 986 437 047</b>
<b>Meriva</b>							
<b>1.3 CDTI [A]</b>	1,3	55	Y 13 DT <Ecotec>; Z 13 DT <Ecotec>; Z 13 DTJ <Ecotec>	09.03-03.10		<b>0 445 010 278</b>	<b>0 986 437 201</b>
CDTI [B]	1,2	55	A 13 DTC <Ecotec>	04.10→		<b>0 445 010 278</b>	<b>0 986 437 201</b>
		70	A 13 DTE <ecoFLEX>	04.10→	SSJ	<b>0 445 010 293</b>	<b>0 986 437 036</b>
<b>Omega</b>							
<b>2.5 DTI Turbo [B]</b>	2,5	110	Y 25 TD	06.01-09.03		<b>0 445 010 009</b>	<b>0 986 437 004</b>
<b>Signum</b>							
<b>1.9 CDTI</b>	1,9	74	Z 19 DTL <Ecotec>	08.05-09.08	LLE	<b>0 445 010 288</b>	<b>0 986 437 025</b>
					RLE	<b>0 445 010 287</b>	<b>0 986 437 026</b>
		88	Z 19 DT <Ecotec>	04.04-09.08	LLE	<b>0 445 010 288</b>	<b>0 986 437 025</b>
					RLE	<b>0 445 010 287</b>	<b>0 986 437 026</b>
		110	Z 19 DTH <Ecotec>	04.04-09.08	LLE	<b>0 445 010 288</b>	<b>0 986 437 025</b>
			Mot.Nr. →17579269	04.04-09.08	RLE	<b>0 445 010 287</b>	<b>0 986 437 026</b>
	Mot.Nr. 17579270→	04.04-09.08	RLE	<b>0 445 010 371</b>	<b>0 986 437 047</b>		
<b>Tigra TwinTop</b>							
<b>1.3 CDTI [B]</b>	1,3	51	Z 13 DT <Turbo Ecotec>	06.04-03.09		<b>0 445 010 278</b>	<b>0 986 437 201</b>
<b>Vectra</b>							
<b>1.9 CDTI, CDTI GTS [C]</b>	1,9	74/88	Z 19 DT <Ecotec>; Z 19 DTL <Ecotec>	04.04-10.08	LLE	<b>0 445 010 288</b>	<b>0 986 437 025</b>
					RLE	<b>0 445 010 287</b>	<b>0 986 437 026</b>



<b>1.9</b> CDTI, CDTI GTS [C]	1,9	110	Z 19 DTH <Ecotec>	04.04-03.08	LLE	<b>0 445 010 288</b>	<b>0 986 437 025</b>
			Mot.Nr. →17579269	04.04-03.08	RLE	<b>0 445 010 287</b>	<b>0 986 437 026</b>
			Mot.Nr. 17579270→	04.04-03.08	RLE	<b>0 445 010 371</b>	<b>0 986 437 047</b>
<b>Vectra Caravan</b>							
<b>1.9</b> CDTI [C]	1,9	74/88	Z 19 DT <Ecotec>; Z 19 DTL <Ecotec>	04.04-10.08	LLE	<b>0 445 010 288</b>	<b>0 986 437 025</b>
					RLE	<b>0 445 010 287</b>	<b>0 986 437 026</b>
		110	Z 19 DTH <Ecotec>	04.04-03.08	LLE	<b>0 445 010 288</b>	<b>0 986 437 025</b>
			Mot.Nr. →17579269	04.04-03.08	RLE	<b>0 445 010 287</b>	<b>0 986 437 026</b>
			Mot.Nr. 17579270→	04.04-03.08	RLE	<b>0 445 010 371</b>	<b>0 986 437 047</b>
<b>Zafira</b>							
<b>1.9</b> CDTI [B]	1,9	74	Z 19 DTL <Ecotec>	07.05-03.08	LLE	<b>0 445 010 288</b>	<b>0 986 437 025</b>
					RLE	<b>0 445 010 287</b>	<b>0 986 437 026</b>
		88	Z 19 DT <Ecotec>	07.05→	LLE	<b>0 445 010 288</b>	<b>0 986 437 025</b>
					RLE	<b>0 445 010 287</b>	<b>0 986 437 026</b>
		110	Z 19 DTH <Ecotec>	07.05→	LLE	<b>0 445 010 288</b>	<b>0 986 437 025</b>
			Mot.Nr. →17579269	07.05→	RLE	<b>0 445 010 287</b>	<b>0 986 437 026</b>
	Mot.Nr. 17579270→	07.05→	RLE	<b>0 445 010 371</b>	<b>0 986 437 047</b>		
<b>2.0</b> CDTI [B]	2,0	81	A 20 DTL	01.12→		<b>0 445 010 371</b>	<b>0 986 437 047</b>
			A 20 DT <ecoFLEX>	01.12→	SSJ	<b>0 445 010 371</b>	<b>0 986 437 047</b>
		121	A 20 DTH <ecoFLEX>	01.12→	SSJ	<b>0 445 010 371</b>	<b>0 986 437 047</b>
					SSJ	<b>0 445 010 382</b>	

**PEUGEOT**

<b>Bipper</b>									
<b>1.4</b> HDi [A9]	1,4	50	8HS <DV4TED>	02.08→		<b>0 445 010 296</b>	<b>0 986 437 028</b>		
<b>Expert</b>									
<b>1.6</b> HDi [G9]	1,6	66	9HM <DV6U C>	12.10→		<b>0 445 010 552</b>			
			9HU <DV6UTED4>	02.07→		<b>0 445 010 296</b>	<b>0 986 437 028</b>		
<b>2.0</b> HDi [U64]	2,0	70	RHX <DW10BTED>						
			Org.Nr. →9008	10.99-07.01		<b>0 445 010 010</b>	<b>0 986 437 005</b>		
			Org.Nr. 9009→10558	08.01-10.05		<b>0 445 010 046</b>	<b>0 986 437 017</b>		
			Org.Nr. 10559→	11.05-01.07		<b>0 445 010 132</b>	<b>0 986 437 018</b>		
		80	RHZ <DW10ATED>						
			Org.Nr. →9008	10.99-07.01		<b>0 445 010 010</b>	<b>0 986 437 005</b>		
			Org.Nr. 9009→	08.01-01.07		<b>0 445 010 046</b>	<b>0 986 437 017</b>		
		81	RHW <DW10ATED4/L4>	06.00-01.07		<b>0 445 010 021</b>	<b>0 986 437 012</b>		
		<b>Partner</b>							
		<b>1.6</b> HDi [B9]	1,6	55/66/68	9HF <DV6DTEDE>; 9HJ <DV6DTEDE M>; 9HK <DV6ETED M>; 9HN <DV6ETED4>; 9HP <DV6DTEDE>	07.10→		<b>0 445 010 552</b>	
55/66/80	9HS <DV6TED4BU/FAP>; 9HT <DV6B/DV6BUTED4>; 9HV <DV6TED4/FAP>; 9HX <DV6ATED4/DV6AUTED4>; 9HZ <DV6TED4 FAP>				05.08→		<b>0 445 010 296</b>	<b>0 986 437 028</b>	
Hdi [M5]	1,6			55/66	9HW <DV6BTED4>; 9HX <DV6ATED4>	09.05-04.08		<b>0 445 010 296</b>	<b>0 986 437 028</b>
<b>2.0</b> HDi [M4]	2,0	66	RHY <DW10TD>						
			Org.Nr. →8994	12.99-06.01	BO	<b>0 445 010 010</b>	<b>0 986 437 005</b>		
			Org.Nr. 8995→	07.01-08.02	BO	<b>0 445 010 046</b>	<b>0 986 437 017</b>		
HDI	2,0	66	DW10TD	10.00→		<b>0 445 010 010</b>	<b>0 986 437 005</b>		
<b>206</b>									
<b>1.4</b> HDi [T1]	1,4	50	8H... <DV4TD>						
			Org.Nr. →10100	09.01-06.04		<b>0 445 010 042</b>	<b>0 986 437 309</b>		
			Org.Nr. 10101→	07.04-02.09		<b>0 445 010 296</b>	<b>0 986 437 028</b>		
<b>1.6</b> HDi [T1]	1,6	80	9H... <DV6TED4>						
			Org.Nr. →10247	05.04-11.04		<b>0 445 010 089</b>	<b>0 986 437 322</b>		
			Org.Nr. 10248→	12.04-03.07		<b>0 445 010 296</b>	<b>0 986 437 028</b>		
<b>2.0</b> HDi	2,0	66	RHY <DW10TD>	05.02-10.03		<b>0 445 010 010</b>	<b>0 986 437 005</b>		
			Hdi [T1]	2,0	66	RHY <DW10TD>			
			Org.Nr. →8945	04.99-05.01		<b>0 445 010 010</b>	<b>0 986 437 005</b>		
			Org.Nr. 8946→10262	06.01-12.04		<b>0 445 010 046</b>	<b>0 986 437 017</b>		
			Org.Nr. 10263→	01.05-10.05		<b>0 445 010 132</b>	<b>0 986 437 018</b>		





◀ PEUGEOT

206+						
1.4 HDi [T3E]	1,4	50	8HR <DV4C>	06.10→	0 445 010 552	
			8HZ <DV4TD>	03.09→	0 445 010 296	0 986 437 028
206 CC						
1.6 HDi [T1]	1,6	80	9H... <DV6TED4>	06.05-03.07	0 445 010 296	0 986 437 028
206 Sedan						
1.4 HDi 16V [T1]	1,4	50	8H... <DV4TD>	09.08-12.10	0 445 010 296	0 986 437 028
206 SW						
1.4 HDi [T1]	1,4	50	8HX <DV4TD>			
			Org.Nr. →10100	03.02-06.04	0 445 010 042	0 986 437 309
			Org.Nr. 10101→	07.04-12.06	0 445 010 296	0 986 437 028
1.6 HDi [T1]	1,6	80	9H... <DV6TED4>			
			Org.Nr. →10247	05.04-11.04	0 445 010 089	0 986 437 322
			Org.Nr. 10248→	12.04-12.06	0 445 010 296	0 986 437 028
2.0 HDi [T1]	2,0	66	RHY <DW10TD>			
			Org.Nr. →10262	03.02-12.04	0 445 010 046	0 986 437 017
			Org.Nr. 10263→	01.05-10.05	0 445 010 132	0 986 437 018
207						
1.4 HDi [A7]	1,4	50	8HR <DV4C>	05.10→	0 445 010 552	
			8HZ <DV4TD>	05.06-04.10	0 445 010 296	0 986 437 028
1.6 HDi [A7]	1,6	66/80	9H... <DV6TED4>; 9HV <DV6TED4/FAP>;	05.06-04.11	0 445 010 296	0 986 437 028
			9HX <DV6ATED4>			
		68	9HP <DV6DTED>	04.10→	0 445 010 552	
207 CC						
1.6 HDi [A7]	1,6	80	9HZ <DV6TED4>	03.07-02.11	0 445 010 296	0 986 437 028
207 SW						
1.6 HDi [A7]	1,6	66/80	9H... <DV6TED4>; 9HV <DV6TED4/FAP>;	06.07-04.11	0 445 010 296	0 986 437 028
			9HX <DV6ATED4>			
		68	9HP <DV6DTED>	04.10→	0 445 010 552	
208						
1.4 HDi	1,4	50	8H... <DV4C>	01.12→	0 445 010 552	
1.6 HDi	1,6	68	9HP <DV6DTED>	01.12→	0 445 010 552	
306						
2.0 HDi [N5]	2,0	66	RHY <DW10TD>			
			Org.Nr. →9015	06.99-07.01	0 445 010 010	0 986 437 005
			Org.Nr. 9016→	08.01-10.03	0 445 010 046	0 986 437 017
HDI	2,0	66	<DW10TD>	12.00→	0 445 010 010	0 986 437 005
306 Break						
2.0 HDi [N5]	2,0	66	RHY <DW10TD>			
			Org.Nr. →9015	06.99-07.01	0 445 010 010	0 986 437 005
			Org.Nr. 9016→	08.01-03.02	0 445 010 046	0 986 437 017
307						
1.4 HDi [T5]	1,4	50	8HZ <DV4TD>			
			Org.Nr. →10100	10.01-06.04	0 445 010 042	0 986 437 309
			Org.Nr. 10101→	07.04-05.05	0 445 010 296	0 986 437 028
1.6 HDi [T5]	1,6	80	9H... <DV6TED4>			
			Org.Nr. →10191	02.04-10.04	0 445 010 089	0 986 437 322
			Org.Nr. 10192→	11.04-05.05	0 445 010 296	0 986 437 028
HDi [T6]	1,6	66/80	9H... <DV6TED4>; 9HV <DV6TED4/FAP>;	06.05-08.07	0 445 010 296	0 986 437 028
			9HX <DV6ATED4>			
2.0 HDi [T5]	2,0	66	RHY <DW10TD>	11.04→	0 445 010 010	0 986 437 005
			Org.Nr. →8973	08.00-06.01 BO	0 445 010 010	0 986 437 005
			Org.Nr. 8974→10264	07.01-12.04 BO	0 445 010 046	0 986 437 017
			Org.Nr. 10265→	01.05-05.05 BO	0 445 010 132	0 986 437 018
		79	RHS <DW10ATED/FAP>			
			Org.Nr. →10262	03.02-12.04	0 445 010 046	0 986 437 017
			Org.Nr. 10263→	01.05-05.05	0 445 010 132	0 986 437 018
307 Break/SW						
1.4 HDi [T5]	1,4	50	8HZ <DV4TD>			
			Org.Nr. →10100	03.02-06.04	0 445 010 042	0 986 437 309
			Org.Nr. 10101→	07.04-05.05	0 445 010 296	0 986 437 028







<b>1.6</b> HDi [T5]	1,6	80	9H... <DV6TED4> Org.Nr. →10191 Org.Nr. 10192→	02.04-10.04 11.04-05.05	<b>0 445 010 089</b> <b>0 986 437 322</b> <b>0 445 010 296</b> <b>0 986 437 028</b>
HDi [T6]	1,6	66/80	9H... <DV6TED4>; 9HV <DV6TED4/FAP>; 9HX <DV6ATED4>	06.05-05.08	<b>0 445 010 296</b> <b>0 986 437 028</b>
<b>2.0</b> HDi [T5]	2,0	66	RHY <DW10TD> Org.Nr. →10264 Org.Nr. 10265→	03.02-12.04 BO 01.05-05.05 BO	<b>0 445 010 046</b> <b>0 986 437 017</b> <b>0 445 010 132</b> <b>0 986 437 018</b>
		79	RHS <DW10ATED/FAP> Org.Nr. →10262 Org.Nr. 10263→	03.02-12.04 01.05-05.05	<b>0 445 010 046</b> <b>0 986 437 017</b> <b>0 445 010 132</b> <b>0 986 437 018</b>
<b>308</b>					
<b>1.6</b> HDi [T7]	1,6	66/80	9HV <DV6TED4/FAP>; 9HX <DV6ATED4>; 9HZ <DV6TED4/FAP>	09.07→	<b>0 445 010 296</b> <b>0 986 437 028</b>
		68	9HJ <DV6DTE M>; 9HP <DV6DTE D>	04.10→	<b>0 445 010 552</b>
<b>308 SW</b>					
<b>1.6</b> HDi [T7]	1,6	66/80	9H... <DV6TED4>; 9HV <DV6TED4/FAP>; 9HX <DV6ATED4>	05.08→	<b>0 445 010 296</b> <b>0 986 437 028</b>
		68	9HJ <DV6DTE M>; 9HP <DV6DTE D>	06.10→	<b>0 445 010 552</b>
<b>406</b>					
<b>2.0</b> HDi [D8]	2,0	80	RHZ <DW10ATED>	10.98-03.99	<b>0 445 010 010</b> <b>0 986 437 005</b>
HDi [D9]	2,0	66	RHY <DW10TD> Org.Nr. →8945 Org.Nr. 8946→	04.99-05.01 BO 06.01-06.04 BO	<b>0 445 010 010</b> <b>0 986 437 005</b> <b>0 445 010 046</b> <b>0 986 437 017</b>
		79	RHS <DW10ATED/FAP>	08.01-06.04	<b>0 445 010 046</b> <b>0 986 437 017</b>
		80	RHZ <DW10ATED> Org.Nr. →8945 Org.Nr. 8946→	04.99-05.01 06.01-06.04	<b>0 445 010 010</b> <b>0 986 437 005</b> <b>0 445 010 046</b> <b>0 986 437 017</b>
<b>2.2</b> HDi [D9]	2,2	98	4HX <DW12TED4>	03.00-06.04	<b>0 445 010 021</b> <b>0 986 437 012</b>
<b>406 Break</b>					
<b>2.0</b> HDi [D8]	2,0	80	RHZ <DW10ATED>	10.98-03.99	<b>0 445 010 010</b> <b>0 986 437 005</b>
HDi [D9]	2,0	66	RHY <DW10TD> Org.Nr. →8945 Org.Nr. 8946→	04.99-05.01 BO 06.01-06.04 BO	<b>0 445 010 010</b> <b>0 986 437 005</b> <b>0 445 010 046</b> <b>0 986 437 017</b>
		79	RHS <DW10ATED/FAP>	08.01-06.04	<b>0 445 010 046</b> <b>0 986 437 017</b>
		80	RHZ <DW10ATED> Org.Nr. →8945 Org.Nr. 8946→	04.99-05.01 06.01-06.04	<b>0 445 010 010</b> <b>0 986 437 005</b> <b>0 445 010 046</b> <b>0 986 437 017</b>
<b>2.2</b> HDi [D9]	2,2	98	4HX <DW12TED4>	03.00-06.04	<b>0 445 010 021</b> <b>0 986 437 012</b>
<b>406 Coupé</b>					
<b>2.2</b> HDi [D9]	2,2	98	4HX <DW12TED4>	03.00-02.05	<b>0 445 010 021</b> <b>0 986 437 012</b>
<b>407</b>					
<b>1.6</b> HDi [D2]	1,6	80	9H... <DV6TED4> Org.Nr. →10247 Org.Nr. 10248→	05.04-11.04 12.04→	<b>0 445 010 089</b> <b>0 986 437 322</b> <b>0 445 010 296</b> <b>0 986 437 028</b>
<b>2.2</b> HDi [D2]	2,2	125	4H... <DW12BTED4>	05.06→	<b>0 445 010 367</b> <b>0 986 437 034</b>
<b>407 Coupé</b>					
<b>3.0</b> HDi 24V [D2]	3,0	177	X8Z <DT20C>	07.09→	<b>0 445 010 614</b>
<b>407 SW</b>					
<b>1.6</b> HDi [D2]	1,6	80	9H... <DV6TED4> Org.Nr. →10247 Org.Nr. 10248→	05.04-11.04 12.04→	<b>0 445 010 089</b> <b>0 986 437 322</b> <b>0 445 010 296</b> <b>0 986 437 028</b>
<b>2.2</b> HDi [D2]	2,2	125	4H... <DW12BTED4>	09.06→	<b>0 445 010 367</b> <b>0 986 437 034</b>
<b>508</b>					
<b>2.2</b> HDi	2,2	150	4HL <DW12C>	10.10→	<b>0 445 010 367</b> <b>0 986 437 034</b>
<b>508 SW</b>					
<b>2.2</b> HDi	2,2	150	4HL <DW12C>	10.10→	<b>0 445 010 367</b> <b>0 986 437 034</b>
<b>607</b>					
<b>2.0</b> HDi [Z8]	2,0	79/80	RHS <DW10ATED/FAP>; RHZ <DW10ATED>	03.00-11.04	<b>0 445 010 046</b> <b>0 986 437 017</b>
HDi [Z9]	2,0	79	RHS <DW10ATED>	12.04-12.07	<b>0 445 010 046</b> <b>0 986 437 017</b>
<b>2.2</b> HDi [Z8]	2,2	98	4HX <DW12TED4>	03.00-11.04	<b>0 445 010 021</b> <b>0 986 437 012</b>
HDi [Z9]	2,2	98	4HX <DW12TED4>	12.04-12.07	<b>0 445 010 021</b> <b>0 986 437 012</b>
		125	4H... <DW12BTED4>	05.06→	<b>0 445 010 367</b> <b>0 986 437 034</b>





◀ PEUGEOT

<b>806</b>							
2.0 HDi [U60]	2,0	80	RHZ <DW10ATED> Org.Nr. →9008 Org.Nr. 9009→		08.99-07.01 08.01-08.02	<b>0 445 010 010</b> <b>0 445 010 046</b>	<b>0 986 437 005</b> <b>0 986 437 017</b>
		81	RHW <DW10ATED4/L4>		06.00-08.02	<b>0 445 010 021</b>	<b>0 986 437 012</b>
<b>807</b>							
2.0 HDi [V2]	2,0	81	RH... <DW10ATED4/FAP>; RHW <DW10ATED4>		06.02-12.06	<b>0 445 010 021</b>	<b>0 986 437 012</b>
2.2 HDi [V2]	2,2	94	4HW <DW12TED4/FAP>		06.02-07.06	<b>0 445 010 021</b>	<b>0 986 437 012</b>
		125	4H ... <DW12BTED4>		09.07-05.10	<b>0 445 010 367</b>	<b>0 986 437 034</b>
<b>1007</b>							
1.6 HDi [A8]	1,6	80	9HZ <DV6TED4>		03.07→	<b>0 445 010 296</b>	<b>0 986 437 028</b>
<b>3008</b>							
1.6 HDi [T8]	1,6	80	9HZ <DV6TED4/FAP>		05.09→	<b>0 445 010 296</b>	<b>0 986 437 028</b>
<b>4007</b>							
2.2 HDi 4x4 [I3]	2,2	115	4HK <DW12ME5>; 4HN <DW12METED4 /FAP>		09.07→	<b>0 445 010 367</b>	<b>0 986 437 034</b>
<b>5008</b>							
1.6 HDi [T8]	1,6	80	9H... <DV6TED4/FAP>		09.09→	<b>0 445 010 296</b>	<b>0 986 437 028</b>

**RENAULT**

<b>Avantime</b>							
2.2 DCi [XEO]	2,2	110	G9T 712		12.01-12.03	<b>0 445 010 033</b>	<b>0 986 437 302</b>
<b>Espace III</b>							
2.2 dCi [JEO]	2,2	85-95	G9T...		07.00-10.02	<b>0 445 010 028</b>	<b>0 986 437 015</b>
<b>Espace IV</b>							
1.9 dCi [JK0]	1,9	88	F9Q 680; F9Q 820; F9Q 826		11.02-12.06	<b>0 445 010 075</b>	<b>0 986 437 301</b>
2.0 dCi [JK]	2,0	96/110/ 127	M9R 740; M9R 760		05.05→	<b>0 445 010 099</b>	<b>0 986 437 355</b>
		2,0	127 M9R 761		05.05→	<b>0 445 010 099</b>	<b>0 986 437 355</b>
2.2 dCi [JK]	2,2	102	G9T 645		07.05→	<b>0 445 010 081</b>	
		2,2	110 G9T 642		11.02-12.06	<b>0 445 010 081</b>	
			G9T 742; G9T 743		11.02-12.06	<b>0 445 010 033</b>	<b>0 986 437 302</b>
<b>Kangoo I</b>							
1.9 DCi, DCi 4x4 [FC./KC.]	1,9	59	F9Q 790		05.00-12.07	<b>0 445 010 018</b>	<b>0 986 437 010</b>
<b>Koleos</b>							
2.0 dCi, dCi 4x4 [HY]	2,0	110	M9R 832		09.08-10.08	<b>0 445 010 170</b>	<b>0 986 437 037</b>
					11.08→	<b>0 445 010 223</b>	<b>0 986 437 044</b>
			M9R 833		09.08-10.08	<b>0 445 010 170</b>	<b>0 986 437 037</b>
					11.08→	<b>0 445 010 223</b>	<b>0 986 437 044</b>
		2,0	127 M9R 830		09.08-10.08	<b>0 445 010 170</b>	<b>0 986 437 037</b>
					11.08→	<b>0 445 010 223</b>	<b>0 986 437 044</b>
<b>Laguna I</b>							
1.9 DCi [B56]	1,9	80	F9Q 718		09.99-02.01	<b>0 445 010 018</b>	<b>0 986 437 010</b>
<b>Laguna I Grandtour</b>							
1.9 DCi [K56]	1,9	80	F9Q 718		09.99-02.01	<b>0 445 010 018</b>	<b>0 986 437 010</b>
<b>Laguna II</b>							
1.9 DCi [BG.]	1,9	68/81/88	F9Q 650; F9Q 664; F9Q 670; F9Q 674; F9Q 750		03.01-09.07	<b>0 445 010 075</b>	<b>0 986 437 301</b>
		74	F9Q 751; F9Q 752; F9Q 754		03.01-09.07	<b>0 445 010 018</b>	<b>0 986 437 010</b>
		96	F9Q 758; F9Q 759		01.05-09.07	<b>0 445 010 087</b>	
2.0 DCi [BG.]	2,0	110/127	M9R 740; M9R 760		09.04-09.07	<b>0 445 010 099</b>	<b>0 986 437 355</b>
2.2 DCi [BG.]	2,2	102/110	G9T 600; G9T 605		07.02-09.07	<b>0 445 010 081</b>	
		110	G9T 700; G9T 702; G9T 703; G9T 706; G9T 707		03.01-09.07	<b>0 445 010 033</b>	<b>0 986 437 302</b>
<b>Laguna II Grandtour</b>							
1.9 DCi [KG.]	1,9	68/81	F9Q 664; F9Q 670; F9Q 674		01.05-09.07	<b>0 445 010 075</b>	<b>0 986 437 301</b>
		74-79	F9Q 752; F9Q 754		03.01-12.05	<b>0 445 010 018</b>	<b>0 986 437 010</b>
		88	F9Q 650; F9Q 750		03.01-09.07	<b>0 445 010 075</b>	<b>0 986 437 301</b>
		96	F9Q 758; F9Q 759		04.04-09.07	<b>0 445 010 087</b>	
2.0 DCi [KG.]	2,0	110/127	M9R 740; M9R 760		09.04-09.07	<b>0 445 010 099</b>	<b>0 986 437 355</b>
2.2 DCi [KG.]	2,2	102/110	G9T 600; G9T 605		07.02-09.07	<b>0 445 010 081</b>	
		110	G9T 700; G9T 702; G9T 703; G9T 706; G9T 707		03.01-09.07	<b>0 445 010 033</b>	<b>0 986 437 302</b>





<b>Laguna III</b>							
2.0 DCI [BT]	2,0	96/110	M9R 802	10.07-10.08	0 445 010 170	0 986 437 037	
				11.08→	0 445 010 223	0 986 437 044	
	110		M9R 742	10.07→	0 445 010 099	0 986 437 355	
			M9R 805	10.07-10.08	0 445 010 170	0 986 437 037	
				11.08→	0 445 010 223	0 986 437 044	
	127		M9R 800	10.07-10.08	0 445 010 170	0 986 437 037	
				11.08→	0 445 010 223	0 986 437 044	
	131		M9R 816	02.08-10.08	0 445 010 170	0 986 437 037	
			11.08→	0 445 010 223	0 986 437 044		
<b>Laguna III Coupé</b>							
2.0 DCI [DT]	2,0	110	M9R 742	02.08→	0 445 010 099	0 986 437 355	
			M9R 802	02.08-10.08	0 445 010 170	0 986 437 037	
				11.08→	0 445 010 223	0 986 437 044	
	127		M9R 805	02.08-10.08	0 445 010 170	0 986 437 037	
				11.08→	0 445 010 223	0 986 437 044	
	131		M9R 800	02.08-10.08	0 445 010 170	0 986 437 037	
				11.08→	0 445 010 223	0 986 437 044	
	131		M9R 816	02.08-10.08	0 445 010 170	0 986 437 037	
			11.08→	0 445 010 223	0 986 437 044		
<b>Laguna III Grandtour</b>							
2.0 DCI [KT]	2,0	96/110	M9R 802	10.07-10.08	0 445 010 170	0 986 437 037	
				11.08→	0 445 010 223	0 986 437 044	
	110		M9R 742	10.07→	0 445 010 099	0 986 437 355	
			M9R 805	10.07-10.08	0 445 010 170	0 986 437 037	
				11.08→	0 445 010 223	0 986 437 044	
	127		M9R 800	10.07-10.08	0 445 010 170	0 986 437 037	
				11.08→	0 445 010 223	0 986 437 044	
	131		M9R 816	02.08-10.08	0 445 010 170	0 986 437 037	
			11.08→	0 445 010 223	0 986 437 044		
<b>Latitude</b>							
2.0 dCi [L7]	2,0	110/127	M9R 804; M9R 817; M9R 824	09.10→	0 445 010 223	0 986 437 044	
<b>Megane I</b>							
1.9 DCI [X64]	1,9	72-75	F9Q 732; F9Q 733; F9Q 738	03.99-10.02	0 445 010 018	0 986 437 010	
<b>Megane I Classic</b>							
1.9 DCI [X64]	1,9	72-75	F9Q 732; F9Q 733; F9Q 738	04.99-09.03	0 445 010 018	0 986 437 010	
<b>Megane I Coupé</b>							
1.9 DCI [X64]	1,9	72-75	F9Q 732; F9Q 733	03.99-10.02	0 445 010 018	0 986 437 010	
<b>Megane I Grandtour</b>							
1.9 DCI [X64]	1,9	72-75	F9Q 732; F9Q 733; F9Q 738	03.99-09.03	0 445 010 018	0 986 437 010	
<b>Megane II</b>							
1.9 DCI [LM]	1,9	68/88	F9Q 800; F9Q 808	10.03-10.09	0 445 010 075	0 986 437 301	
		96	F9Q 803; F9Q 804	09.04-10.09	0 445 010 087		
2.0 DCI [LM]	2,0	110	M9R 700	09.04-10.09	0 445 010 099	0 986 437 355	
<b>Megane II Cabrio</b>							
1.9 DCI [EM]	1,9	88	F9Q 800	10.03-03.10	0 445 010 075	0 986 437 301	
		96	F9Q 803; F9Q 804; F9Q 814	05.04-03.10	0 445 010 087		
2.0 DCI [EM]	2,0	110	M9R 700; M9R 722	09.04-03.10	0 445 010 099	0 986 437 355	
<b>Megane II Grandtour</b>							
1.9 DCI [KM.]	1,9	68/88	F9Q 800; F9Q 808	10.03-05.09	0 445 010 075	0 986 437 301	
		96	F9Q 803; F9Q 804	09.04-05.09	0 445 010 087		
2.0 DCI [KM.]	2,0	110	M9R 700; M9R 722	09.04-05.09	0 445 010 099	0 986 437 355	
<b>Megane II Hatchback</b>							
1.9 DCI [BM./CM./GM./SM.]	1,9	68/88	F9Q 800; F9Q 808	11.02-10.08	0 445 010 075	0 986 437 301	
		96	F9Q 803; F9Q 804	09.04-10.08	0 445 010 087		
2.0 DCI [BM./CM./GM./SM.]	2,0	110	M9R 700; M9R 722	09.04-10.08	0 445 010 099	0 986 437 355	
<b>Megane III CC</b>							
1.9 dCi [EZ]	1,9	96	F9Q 870	10.10→	0 445 010 216		
<b>Megane III Coupé</b>							
1.9 dCi [DZ]	1,9	96	F9Q 870	01.09→	0 445 010 216		
			F9Q 872	01.09→	0 445 010 218	0 986 437 043	





◀ RENAULT

Megane III Grandtour							
1.9 dCi [KZ]	1,9	96	F9Q 870	06.09→	0 445 010 216		
			F9Q 872	06.09→	0 445 010 218	0 986 437 043	
Megane III Hatchback							
1.9 dCi [BZ]	1,9	96	F9Q 870	11.08→	0 445 010 216		
			F9Q 872	11.08→	0 445 010 218	0 986 437 043	
Scenic I							
1.9 dCi, dCi RX4 [JA.]	1,9	75	F9Q 732; F9Q 733; F9Q 738; F9Q 740; F9Q 746; F9Q 748; F9Q 796	06.97-04.03	0 445 010 018 0 986 437 010		
Scenic II							
1.9 dCi [JM]	1,9	81/96	F9Q 803; F9Q 804	05.03-04.09	0 445 010 087		
		88	F9Q 812	05.03-04.09	0 445 010 075	0 986 437 301	
2.0 dCi [JM]	2,0	110	M9R 700; M9R 721	09.04-04.09	0 445 010 099 0 986 437 355		
Scenic III							
1.6 dCi [J95]	1,6	96	R9M 402	03.11→	0 445 010 250 0 986 437 045		
1.9 dCi [J95]	1,9	96	F9Q 870	05.09→	0 445 010 216		
			F9Q 872	05.09→	0 445 010 218	0 986 437 043	
Vel Satis							
2.0 dCi [BJ]	2,0	110/127	M9R 760	08.05-12.09	0 445 010 099 0 986 437 355		
2.2 dCi [BJ]	2,2	102/110	G9T 600; G9T 606; G9T 607	09.02-12.09	0 445 010 081		
		110	G9T 702; G9T 703	04.02-12.09	0 445 010 033	0 986 437 302	

**ROVER**

75							
2.0 CDT, CDTi	2,0	85/96	20 4D 2 <M 47 D 20>	01.99-05.05	0 445 010 011 0 986 437 006		
75 Tourer							
2.0 CDT, CDTi	2,0	85/96	20 4D 2 <M 47 D 20>	01.01-05.05	0 445 010 011 0 986 437 006		

**SAAB (SAAB AUTOMOBILE AB)**

9-3								
1.9 TiD [9440]	1,9	88	Z19DT	09.04→	LLE	0 445 010 288 0 986 437 025		
					RLE	0 445 010 287 0 986 437 026		
			110	Z19DTH	09.04→	LLE	0 445 010 288 0 986 437 025	
						RLE	0 445 010 287 0 986 437 026	
TTiD [9440]	1,9	96/118/132	A19DTR (130); A19DTR (160); Z19DTR	02.08→	0 445 010 173			
9-3 Cabriolet								
1.9 TiD [9440]	1,9	110	Z19DTH	01.06→	LLE	0 445 010 288 0 986 437 025		
					RLE	0 445 010 287 0 986 437 026		
TTiD [9440]	1,9	118/132	A19DTR (160); Z19DTR	02.08→	0 445 010 173			
9-3 Kombi								
1.9 TiD [9440]	1,9	88	Z19DT	03.05→	LLE	0 445 010 288 0 986 437 025		
					RLE	0 445 010 287 0 986 437 026		
			110	Z19DTH	03.05→	LLE	0 445 010 288 0 986 437 025	
						RLE	0 445 010 287 0 986 437 026	
TTiD [9440]	1,9	96/118/132	A19DTR (130); A19DTR (160); Z19DTR	02.08→	0 445 010 173			
9-3X								
1.9 TTiD	1,9	132	Z19DTR	03.10→	0 445 010 173			
9-5								
1.9 TiD [9600]	1,9	110	Z19DTH	09.05-02.10	LLE	0 445 010 288 0 986 437 025		
					RLE	0 445 010 287 0 986 437 026		
2.0 TiD4 [650]	2,0	118	A 20 DTH	03.10→	0 445 010 193 0 986 437 047			
9-5 Kombi								
1.9 TiD [9600]	1,9	110	Z19DTH	01.06-02.10	LLE	0 445 010 288 0 986 437 025		
					RLE	0 445 010 287 0 986 437 026		
			129	Z19DTH	01.07-02.10	LLE	0 445 010 365	
						RLE	0 445 010 378	





l/ccm



kW/(PS)



Typ



## SEAT

**Alhambra**

2.0 TDI, TDI 4WD [710]	2,0	85/100/ 103/125	CFFA; CFFB; CFFB <D91>; CFFE <DE4>; CFGB	05.10→		<b>0 445 010 567</b>
------------------------	-----	--------------------	--	--------	--	----------------------

**Altea**

2.0 TDI [5P1]	2,0	103	CFHC <D91>	09.10→		<b>0 445 010 551 0 986 437 412</b>
		125	CEGA <D93>	03.09-05.10		<b>0 445 010 546 0 986 437 408</b>

**Altea Freetrack**

2.0 TDI 4WD [5P5/5P8]	2,0	103/125	CFHC <D91>; CFJA <D93>	09.10→		<b>0 445 010 551 0 986 437 412</b>
		125	CEGA <D93>	03.09-10.10		<b>0 445 010 546 0 986 437 408</b>

**Altea XL**

2.0 TDI [5P5]	2,0	103	CFHC <D91>	10.10→		<b>0 445 010 551 0 986 437 412</b>
		125	CEGA <D93>	03.09-05.10		<b>0 445 010 546 0 986 437 408</b>

**Exeo**

2.0 TDI [3R2]	2,0	88/105/ 125	CAGA <D92>; CAGC <D90>; CAHA <D93>	12.08→		<b>0 445 010 546 0 986 437 408</b>
---------------	-----	----------------	------------------------------------	--------	--	------------------------------------

**Exeo ST**

2.0 TDI [3R5]	2,0	88/105/ 125	CAGA <D92>; CAGC <D90>; CAHA <D93>	06.09→		<b>0 445 010 546 0 986 437 408</b>
---------------	-----	----------------	------------------------------------	--------	--	------------------------------------

**Ibiza**

2.0 TDI [6J5]	2,0	105	CFHD <D92>	01.10-04.11		<b>0 445 010 551 0 986 437 412</b>
---------------	-----	-----	------------	-------------	--	------------------------------------

**Ibiza Sportcoupé**

2.0 TDI [6J1]	2,0	105	CFHD <D92>	01.10-04.11		<b>0 445 010 551 0 986 437 412</b>
---------------	-----	-----	------------	-------------	--	------------------------------------

**Leon**

2.0 TDI [1P1]	2,0	103/125	CFHC <D91>; CFJA <D93>; CLCB <D91>	05.10→		<b>0 445 010 551 0 986 437 412</b>
		125	CEGA <D93>	03.09→		<b>0 445 010 546 0 986 437 408</b>

## SKODA

**Octavia**

2.0 TDI [123]	2,0	81	CFHF <D96>						
			PR-Nr. 7MG	02.11→	EU5	<b>0 445 010 551 0 986 437 412</b>			
			PR-Nr. 7ML	02.11→	EU4	<b>0 445 010 566 0 986 437 420</b>			
			CLCA <D96>						
			PR-Nr. 7MG	03.10→	EU5	<b>0 445 010 551 0 986 437 412</b>			
			PR-Nr. 7ML	03.10→	EU4	<b>0 445 010 566 0 986 437 420</b>			
		103	CLCB <D91>						
			PR-Nr. 7MG	02.10→	EU5	<b>0 445 010 551 0 986 437 412</b>			
			PR-Nr. 7ML	02.10→	EU4	<b>0 445 010 566 0 986 437 420</b>			
			TDI RS [123]	2,0	125	CEGA <D93>	05.08→	<b>0 445 010 546 0 986 437 408</b>	
			TDI, TDI 4x4 [123]	2,0	103	CFHC <D91>			
						PR-Nr. 7MG	05.10→	EU5	<b>0 445 010 551 0 986 437 412</b>
PR-Nr. 7ML	05.10→	EU4	<b>0 445 010 566 0 986 437 420</b>						

**Octavia Combi**

2.0 TDI [125]	2,0	81	CLCA <D96>					
			PR-Nr. 7MG	03.10→	EU5	<b>0 445 010 551 0 986 437 412</b>		
			PR-Nr. 7ML	03.10→	EU4	<b>0 445 010 566 0 986 437 420</b>		
			103	CLCB <D91>				
				PR-Nr. 7MG	02.10→	EU5	<b>0 445 010 551 0 986 437 412</b>	
			PR-Nr. 7ML	02.10→	EU4	<b>0 445 010 566 0 986 437 420</b>		
		TDI RS [125]	2,0	125	CEGA <D93>	05.08→	<b>0 445 010 546 0 986 437 408</b>	
		TDI, TDI 4x4 [125]	2,0	81	CFHF <D96>			
					PR-Nr. 7MG	02.11→	EU5	<b>0 445 010 551 0 986 437 412</b>
					PR-Nr. 7ML	02.11→	EU4	<b>0 445 010 566 0 986 437 420</b>
				103	CFHC <D91>			
					PR-Nr. 7MG	05.10→	EU5	<b>0 445 010 551 0 986 437 412</b>
PR-Nr. 7ML	05.10→				EU4	<b>0 445 010 566 0 986 437 420</b>		





◀ SKODA

Superb										
2.0 TDI [3T4]	2,0	103	CLJA							
			PR-Nr. 7MG		02.10→	EU5	0 445 010 551	0 986 437 412		
			PR-Nr. 7ML		02.10→	EU4	0 445 010 566	0 986 437 420		
TDI, TDI 4x4 [3T4]	2,0	103	CFFB <D91>							
			PR-Nr. 7MG		03.10→	EU5	0 445 010 551	0 986 437 412		
			PR-Nr. 7ML		03.10→	EU4	0 445 010 566	0 986 437 420		
		125	CBBB		06.08→		0 445 010 546	0 986 437 408		
			CFGB							
			PR-Nr. 7MG		05.10→	EU5	0 445 010 551	0 986 437 412		
			PR-Nr. 7ML		05.10→	EU4	0 445 010 566	0 986 437 420		
Superb Combi										
2.0 TDI [3T5]	2,0	103	CLJA <D91>							
			PR-Nr. 7MG		02.10→	EU5	0 445 010 551	0 986 437 412		
			PR-Nr. 7ML		02.10→	EU4	0 445 010 566	0 986 437 420		
TDI, TDI 4x4 [3T5]	2,0	103	CFFB <D91>							
			PR-Nr. 7MG		03.10→	EU5	0 445 010 551	0 986 437 412		
			PR-Nr. 7ML		03.10→	EU4	0 445 010 566	0 986 437 420		
		125	CBBB		09.09→		0 445 010 546	0 986 437 408		
			CFGB							
			PR-Nr. 7MG		05.10→	EU5	0 445 010 551	0 986 437 412		
			PR-Nr. 7ML		05.10→	EU4	0 445 010 566	0 986 437 420		
Yeti										
2.0 TDI [5L7]	2,0	81	CLCA <D96>		09.11→	EU4	0 445 010 566	0 986 437 420		
						EU5	0 445 010 551	0 986 437 412		
TDI, TDI 4x4 [5L7]	2,0	81	CFHA <D96>							
			PR-Nr. 7MG		11.09→	EU5	0 445 010 551	0 986 437 412		
			PR-Nr. 7ML		11.09→	EU4	0 445 010 566	0 986 437 420		
		103	CFHC <D91>							
			PR-Nr. 7MG		11.09→	EU5	0 445 010 551	0 986 437 412		
			PR-Nr. 7ML		11.09→	EU4	0 445 010 566	0 986 437 420		
TDI 4x4 [5L7]	2,0	81	CFHF <D96>		11.09→		0 445 010 551	0 986 437 412		
			PR-Nr. 7MG		11.09→	EU5	0 445 010 551	0 986 437 412		
			PR-Nr. 7ML		11.09→	EU4	0 445 010 566	0 986 437 420		
		103	CLCB <D91>							
			PR-Nr. 7MG		05.10→	EU5	0 445 010 551	0 986 437 412		
			PR-Nr. 7ML		05.10→	EU4	0 445 010 566	0 986 437 420		
		103/125	CBDB <D91>; CEGA <D93>		05.09-05.10		0 445 010 546	0 986 437 408		
		125	CFJA <D93>							
			PR-Nr. 7MG		05.10→	EU5	0 445 010 551	0 986 437 412		
			PR-Nr. 7ML		05.10→	EU4	0 445 010 566	0 986 437 420		

**SMART (MCC)**

Forfour										
1.5 cdi [454]	1,5	50/70	639.939							
			Mot.Nr. 30026697→		02.05-06.07		0 445 010 341	0 986 437 368		
Fortwo Cabrio										
0.8 cdi [450]	0,8	30	OM 660.940		02.04-03.07		0 445 010 273	0 986 437 019		
Fortwo Coupé										
0.8 cdi [450]	0,8	30	OM 660.940		02.04-03.07		0 445 010 273	0 986 437 019		
Smart Cabrio										
0.8 cdi [450]	0,8	30	OM 660.940		03.01-01.04		0 445 010 273	0 986 437 019		
Smart Coupé										
0.8 cdi [450]	0,8	30	OM 660.940		11.99-01.04		0 445 010 273	0 986 437 019		



## SUZUKI

Grand Vitara						
2.0 D Turbo	2,0	80	RHW		11.00-12.05	0 445 010 021 0 986 437 012
			RHZ		11.00-12.05	0 445 010 010 0 986 437 005
Ignis Hatchback						
1.3 DDiS Turbo	1,2	51	Z13DT		10.03-12.07	0 445 010 278 0 986 437 201
Swift Hatchback						
1.3 DDiS D Turbo [MZ/EZ]	1,2	51-55	Z13DT			
			Fg.Nr. →00500000		08.05→	0 445 010 278 0 986 437 201
SX4 Hatchback						
1.6 DDiS	1,6	66	9HX		04.07→	0 445 010 296 0 986 437 028
Wagon R+						
1.3 DDiS D Turbo [MM]	1,3	51	Z13DT		09.03-03.06	0 445 010 277

## TOYOTA

Auris						
1.4 D-4D [E15, JTN]	1,4	66	1NDTV		10.06-01.09	0 445 010 105
					02.09→	0 445 010 214
					WW	0 445 010 214
D-4D [E15, NMT, SB1]	1,4	66	1NDTV		02.07-01.09	0 445 010 105
					02.09→	0 445 010 214
					WW	0 445 010 214
Corolla						
1.4 D Turbo [E12, JTD]	1,4	66	1NDTV		01.04-11.06	0 445 010 105
D Turbo [E12, NMT]	1,4	66	1NDTV		08.04-02.07	0 445 010 105
D-4D [E15]	1,4	66	1NDTV		11.06-11.08	0 445 010 105
					12.08-11.11	0 445 010 214
Corolla Hatchback						
1.4 D Turbo [E12]	1,4	66	1NDTV		09.02-12.07	0 445 010 105
Corolla Wagon						
1.4 D Turbo [E12, NMT]	1,4	66	1NDTV		04.04-02.07	0 445 010 105
iQ						
1.4	1,4	66	1NDTV		11.08→	0 445 010 214
Urban Cruiser						
1.4 D-4D 4x4 [P1]	1,4	66	1NDTV		01.09-11.11	0 445 010 214
Verso-S						
1.4 D-4D	1,4	66	1ND-TV		11.10→	0 445 010 214
Yaris						
1.4 D Turbo [P1]	1,4	55	1ND-TV		10.01-08.05	0 445 010 113
			1NDTV		02.03-08.06	0 445 010 112
						0 445 010 113
D-4D [P9, VNK]	1,4	66	1NDTV		11.08→	0 445 010 214
			Mot.Nr. Dxxxxx-Fxxxxx		11.05-10.08	0 445 010 134
			Mot.Nr. Oxxxxx-9xxxxx		11.05-10.08	0 445 010 105
D-4D [P13, VNK]	1,4	66	1NDTV		07.11→	0 445 010 214
Yaris Verso						
1.4 D Turbo [P2]	1,4	55	1NDTV		08.01-09.05	0 445 010 113

## UAZ

Patriot						
2.2 TD 4x4	2,3	85	F1AE0481B		01.07→	0 445 010 181 0 986 437 085





**VAUXHALL**

<b>Agila</b>									
1.3 CDTI [B]	1,2	55	Z 13 DTJ		07.08→			0 445 010 278	0 986 437 201
<b>Antara</b>									
2.0 CDTI 4x4	2,0	93/110	Z 20 DM <Ecotec>; Z 20 DMH <Ecotec> Fg.Nr. →80169709		11.06→			0 445 010 142	0 986 437 032
<b>Astra</b>									
1.3 CDTI [J]	1,2	70	A 13 DTE <eco Flex>		09.09→	SSJ		0 445 010 293	0 986 437 036
1.7 CDTI [H]	1,7	59/74	Z 17 DTH <Turbo Ecotec>; Z 17 DTL <Turbo Ecotec>		03.04-03.07			0 445 010 086	0 986 437 317
CDTI 16V [G]	1,7	59	Z 17 DTL <Turbo>		03.03-08.05			0 445 010 086	0 986 437 317
1.9 CDTI [H]	1,9	74	Z 19 DTL <Turbo Ecotec>		09.05-03.10	LLE		0 445 010 288	0 986 437 025
			Mot.Nr. →17579269		09.05-03.10	RLE		0 445 010 287	0 986 437 026
			Mot.Nr. 17579270→		09.05-03.10	RLE		0 445 010 371	0 986 437 047
	88		Z 19 DT <Turbo Ecotec>		09.05-03.10	LLE		0 445 010 288	0 986 437 025
			Mot.Nr. →17579269		09.05-03.10	RLE		0 445 010 287	0 986 437 026
			Mot.Nr. 17579270→		09.05-03.10	RLE		0 445 010 371	0 986 437 047
			Z 19 DTJ <Turbo Ecotec>		03.04-03.10	LLE		0 445 010 288	0 986 437 025
						RLE		0 445 010 287	0 986 437 026
	110		Z 19 DTH <Turbo Ecotec>		03.04-03.10	LLE		0 445 010 288	0 986 437 025
			Mot.Nr. →17579269		03.04-03.10	RLE		0 445 010 287	0 986 437 026
			Mot.Nr. 17579270→		03.04-03.10	RLE		0 445 010 371	0 986 437 047
2.0 CDTI [J]	2,0	118/121	A 20 DTH <Ecotec>		09.09→	SSJ		0 445 010 371	0 986 437 047
						SSJ		0 445 010 382	
<b>Astra Estate</b>									
1.7 CDTI [G]	1,7	59	Z 17 DTL <Turbo>		03.03-08.05			0 445 010 086	0 986 437 317
CDTI [H]	1,7	59/74	Z 17 DTH <Turbo Ecotec>; Z 17 DTL <Turbo Ecotec>		08.04-03.07			0 445 010 086	0 986 437 317
1.9 CDTI [H]	1,9	74	Z 19 DTL <Turbo Ecotec>		09.05-03.10	LLE		0 445 010 288	0 986 437 025
			Mot.Nr. →17579269		09.05-03.10	RLE		0 445 010 287	0 986 437 026
			Mot.Nr. 17579270→		09.05-03.10	RLE		0 445 010 371	0 986 437 047
	88		Z 19 DT <Turbo Ecotec>		09.05-03.10	LLE		0 445 010 288	0 986 437 025
			Mot.Nr. →17579269		09.05-03.10	RLE		0 445 010 287	0 986 437 026
			Mot.Nr. 17579270→		09.05-03.10	RLE		0 445 010 371	0 986 437 047
			Z 19 DTJ <Turbo Ecotec>		08.04-03.10	LLE		0 445 010 288	0 986 437 025
						RLE		0 445 010 287	0 986 437 026
	110		Z 19 DTH <Turbo Ecotec>		08.04-03.10	LLE		0 445 010 288	0 986 437 025
			Mot.Nr. →17579269		08.04-03.10	RLE		0 445 010 287	0 986 437 026
			Mot.Nr. 17579270→		08.04-03.10	RLE		0 445 010 371	0 986 437 047
<b>Astra GTC</b>									
1.7 CDTI [H]	1,7	59/74	Z 17 DTH <Turbo Ecotec>; Z 17 DTL <Turbo Ecotec>		06.05-03.07			0 445 010 086	0 986 437 317
1.9 CDTI [H]	1,9	88	Z 19 DTJ <Turbo Ecotec>		06.05-03.09	LLE		0 445 010 288	0 986 437 025
						RLE		0 445 010 287	0 986 437 026
	110		Z 19 DTH <Turbo Ecotec>		06.05-12.09	LLE		0 445 010 288	0 986 437 025
			Mot.Nr. →17579269		06.05-12.09	RLE		0 445 010 287	0 986 437 026
			Mot.Nr. 17579270→		06.05-12.09	RLE		0 445 010 371	0 986 437 047
2.0 [J]	2,0	121	A 20 DTH <ecoFLEX>		09.11→	SSJ		0 445 010 371	0 986 437 047
						SSJ		0 445 010 382	
<b>Astra Sports Tourer</b>									
1.3 CDTI [J]	1,2	70	A 13 DTE		09.10→	SSJ		0 445 010 293	0 986 437 036
2.0 CDTI [J]	2,0	118/121	A 20 DTH; A 20 DTH <Ecotec>		09.10→	SSJ		0 445 010 371	0 986 437 047
						SSJ		0 445 010 382	
<b>Astra TwinTop</b>									
1.9 CDTI [H]	1,9	110	Z 19 DTH <Ecotec>		09.05-12.09	LLE		0 445 010 288	0 986 437 025
			Mot.Nr. →17579269		09.05-12.09	RLE		0 445 010 287	0 986 437 026
			Mot.Nr. 17579270→		09.05-12.09	RLE		0 445 010 371	0 986 437 047
<b>Astra Van</b>									
1.7 CDTI [G]	1,7	59	Z 17 DTL <Turbo>		03.03-08.05			0 445 010 086	0 986 437 317
<b>Combo</b>									
1.3 CDTI [Tour]	1,2	51	Z 13 DT <Turbo>		09.04→			0 445 010 277	0 986 437 024
	1,3	51/55	Y 13 DT <Turbo>; Z 13 DTJ <Turbo>		09.04→			0 445 010 277	0 986 437 024







<b>Corsa</b>									
<b>1.3</b> CDTI [C]	1,2	51	Z 13 DT	09.03-09.06		<b>0 445 010 278</b>	<b>0 986 437 201</b>		
	1,3	51/55	Y 13 DT <Turbo Ecotec>; Z 13 DTJ <Turbo Ecotec>	09.03-09.06		<b>0 445 010 277</b>	<b>0 986 437 024</b>		
CDTI [D]	1,2	55	A 13 DTC <Turbo Ecotec>	01.11→	SSJ	<b>0 445 010 278</b>	<b>0 986 437 201</b>		
			Z 13 DTJ <Turbo Ecotec>	07.06→		<b>0 445 010 277</b>	<b>0 986 437 024</b>		
	66	Z 13 DTH <Turbo Ecotec>	07.06→		<b>0 445 010 293</b>	<b>0 986 437 036</b>			
		A 13 DTR <eco Flex>	01.11→		<b>0 445 010 293</b>	<b>0 986 437 036</b>			
	70	Z 13 DTE <eco Flex>	12.09→	SSJ	<b>0 445 010 293</b>	<b>0 986 437 036</b>			
		A 13 DTJ <Turbo Ecotec>	10.06-02.09		<b>0 445 010 277</b>	<b>0 986 437 024</b>			
66	A 13 DTH <Turbo Ecotec>	10.06-02.09		<b>0 445 010 293</b>	<b>0 986 437 036</b>				
<b>Insignia</b>									
<b>2.0</b> CDTI [68]	2,0	81	A 20 DT... <Ecotec>	11.08→	SSJ	<b>0 445 010 371</b>	<b>0 986 437 047</b>		
			A 20 DT... <eco Flex>	11.08→		<b>0 445 010 382</b>			
CDTI [69]	2,0	81	A 20 DT... <Ecotec>	11.08→	SSJ	<b>0 445 010 371</b>	<b>0 986 437 047</b>		
			A 20 DT... <eco Flex>	11.08→		<b>0 445 010 382</b>			
CDTI, CDTI 4x4 [68]	2,0	118	A 20 DTH <ecoFlex>	11.08→		<b>0 445 010 371</b>	<b>0 986 437 047</b>		
CDTI, CDTI 4x4 [69]	2,0	118	A 20 DTH <ecoFlex>	11.08→		<b>0 445 010 371</b>	<b>0 986 437 047</b>		
CDTI 4x4 [68]	2,0	140	A 20 DTR <Ecotec>	07.09→		<b>0 445 010 550</b>			
CDTI 4x4 [69]	2,0	140	A 20 DTR <Ecotec>	07.09→		<b>0 445 010 550</b>			
<b>Insignia Sports Tourer</b>									
<b>2.0</b> CDTI [35]	2,0	81	A 20 DT... <Ecotec>	02.09→	SSJ	<b>0 445 010 371</b>	<b>0 986 437 047</b>		
			A 20 DT... <eco Flex>	02.09→		<b>0 445 010 382</b>			
CDTI, CDTI 4x4 [35]	2,0	118	A 20 DTH <ecoFlex>	02.09→		<b>0 445 010 371</b>	<b>0 986 437 047</b>		
CDTI 4x4 [35]	2,0	140	A 20 DTR <Ecotec>	07.09→		<b>0 445 010 550</b>			
<b>Meriva</b>									
<b>1.3</b> CDTI [A]	1,2	51	Y 13 DT <Ecotec>	09.05-03.10		<b>0 445 010 277</b>	<b>0 986 437 024</b>		
			Z 13 DT <Ecotec>	09.05-03.10		<b>0 445 010 278</b>	<b>0 986 437 201</b>		
	1,3	55	Z 13 DTJ <Ecotec>	09.03-03.10		<b>0 445 010 278</b>	<b>0 986 437 201</b>		
CDTI [B]	1,2	55	A 13 DTC <Ecotec>	06.10→		<b>0 445 010 278</b>	<b>0 986 437 201</b>		
			A 13 DTE <ecoFlex>	06.10→	SSJ	<b>0 445 010 293</b>	<b>0 986 437 036</b>		
<b>Signum</b>									
<b>1.9</b> CDTI	1,9	74	Z 19 DTL <Ecotec>	09.05-09.08	LLE	<b>0 445 010 288</b>	<b>0 986 437 025</b>		
			Z 19 DT <Ecotec>	04.04-09.08	LLE	<b>0 445 010 288</b>	<b>0 986 437 025</b>		
	88	Z 19 DT <Ecotec>	04.04-09.08	RLE	<b>0 445 010 287</b>	<b>0 986 437 026</b>			
		Z 19 DTH <Ecotec>	04.04-09.08	LLE	<b>0 445 010 288</b>	<b>0 986 437 025</b>			
	110	Mot.Nr. →17579269	04.04-09.08	RLE	<b>0 445 010 287</b>	<b>0 986 437 026</b>			
		Mot.Nr. 17579270→	04.04-09.08	RLE	<b>0 445 010 371</b>	<b>0 986 437 047</b>			
<b>Tigra TwinTop</b>									
<b>1.3</b> CDTI [B]	1,3	51	Z 13 DT <Turbo Ecotec>	06.04-03.09		<b>0 445 010 277</b>	<b>0 986 437 024</b>		
<b>Vectra</b>									
<b>1.9</b> CDTI [C]	1,9	74/88	Z 19 DT <Ecotec>; Z 19 DTL <Ecotec>	04.04-10.08	LLE	<b>0 445 010 097</b>	<b>0 986 437 025</b>		
			Z 19 DTH <Ecotec>	04.04-03.08	LLE	<b>0 445 010 288</b>	<b>0 986 437 025</b>		
	110	Mot.Nr. →17579269	04.04-03.08	RLE	<b>0 445 010 287</b>	<b>0 986 437 026</b>			
		Mot.Nr. 17579270→	04.04-03.08	RLE	<b>0 445 010 371</b>	<b>0 986 437 047</b>			
<b>Vectra Estate</b>									
<b>1.9</b> CDTI [C]	1,9	74/88	Z 19 DT <Ecotec>; Z 19 DTL <Ecotec>	04.04-10.08	LLE	<b>0 445 010 097</b>	<b>0 986 437 025</b>		
			Z 19 DTH <Ecotec>	04.04-03.08	LLE	<b>0 445 010 288</b>	<b>0 986 437 025</b>		
	110	Mot.Nr. →17579269	04.04-03.08	RLE	<b>0 445 010 287</b>	<b>0 986 437 026</b>			
		Mot.Nr. 17579270→	04.04-03.08	RLE	<b>0 445 010 371</b>	<b>0 986 437 047</b>			
<b>Zafira</b>									
<b>1.9</b> CDTI [B]	1,9	74	Z 19 DTL <Ecotec>	07.05-03.08	LLE	<b>0 445 010 288</b>	<b>0 986 437 025</b>		
			Z 19 DT <Ecotec>	07.05→	LLE	<b>0 445 010 288</b>	<b>0 986 437 025</b>		
	88	Z 19 DT <Ecotec>	07.05→	RLE	<b>0 445 010 287</b>	<b>0 986 437 026</b>			
		Z 19 DTH <Ecotec>	07.05→	LLE	<b>0 445 010 288</b>	<b>0 986 437 025</b>			
	110	Mot.Nr. →17579269	07.05→	RLE	<b>0 445 010 287</b>	<b>0 986 437 026</b>			
		Mot.Nr. 17579270→	07.05→	RLE	<b>0 445 010 371</b>	<b>0 986 437 047</b>			





**VOLVO**

<b>C30</b>							
2.0 D3	2,0	110	D5204T5		08.10→		<b>0 445 010 110</b>
D4	2,0	130	D5204T		08.10→	EU3	<b>0 445 010 110</b>
						EU4,EU5	<b>0 445 010 655</b>
2.4 D5	2,4	120/132	D5244T8...; D5244T9		10.06-07.10		<b>0 445 010 110</b>
<b>C70 II Cabrio</b>							
2.0 D3	2,0	110	D5204T5		10.10→		<b>0 445 010 655</b>
2.4 D, D5	2,4	120/132	D5244T8...; D5244T9		08.06-07.10		<b>0 445 010 110</b>
<b>S40 II</b>							
2.0 D3, D4	2,0	110/130	D5204T; D5204T5		08.10→		<b>0 445 010 110</b>
2.4 D5	2,4	120/132	D5244T8...; D5244T9		03.06-07.10		<b>0 445 010 110</b>
<b>S60 I</b>							
2.4 D	2,4	96/120	D5244T; D5244T2		08.01-07.06		<b>0 445 010 043 0 986 437 312</b>
D, D5	2,4	93/120/ 136	D5244T4; D5244T5; D5244T7		08.05-07.09		<b>0 445 010 110</b>
<b>S60 II</b>							
2.0 D3	2,0	120	D5204T2; D5204T3		08.10→		<b>0 445 010 655</b>
2.4 D5, D5 AWD	2,4	151/158	D5244T10; D5244T11; D5244T15		08.10→		<b>0 445 010 655</b>
<b>S80 I</b>							
2.4 D, D5	2,4	96/120	D5244T; D5244T2		08.01-07.06		<b>0 445 010 043 0 986 437 312</b>
<b>S80 II</b>							
2.0 D3	2,0	120	D5204T2; D5204T3		08.10→		<b>0 445 010 655</b>
2.4 D, D5, D5 AWD	2,4	120/129/ 151/158	D5244T10; D5244T14; D5244T15; D5244T19		11.08→		<b>0 445 010 655</b>
		120/136	D5244T4; D5244T5		03.06-07.09		<b>0 445 010 110</b>
<b>V50</b>							
2.0 D3, D4	2,0	110/130	D5204T; D5204T5		08.10→		<b>0 445 010 110</b>
2.4 D5	2,4	120/132	D5244T8...; D5244T9		04.06-07.10		<b>0 445 010 110</b>
<b>V60</b>							
2.0 D3	2,0	120	D5204T2		09.10-08.11		<b>0 445 010 655</b>
2.4 D5, D5 AWD	2,4	151/158	D5244T10; D5244T15		09.10→		<b>0 445 010 655</b>
<b>V70 II</b>							
2.4 D, D AWD, D5, D5 AWD	2,4	96/120/ 136	D5244T; D5244T2; D5244T3		08.01-07.06		<b>0 445 010 043 0 986 437 312</b>
D, D5, D5 AWD	2,4	90/93/ 120/136	D5244T4; D5244T5; D5244T6; D5244T7		08.06-07.07		<b>0 445 010 110</b>
<b>V70 III</b>							
2.0 D3	2,0	120	D5204T2; D5204T3		08.10→		<b>0 445 010 655</b>
2.4 D, D5, D5 AWD	2,4	120/136	D5244T4; D5244T5		08.07-07.09		<b>0 445 010 110</b>
		129/151/ 158	D5244T10; D5244T11; D5244T14; D5244T15		08.09→		<b>0 445 010 655</b>
<b>XC60</b>							
2.0 D3 DRIVe	2,0	120	D5204T2; D5204T3		08.10→		<b>0 445 010 655</b>
2.4 D AWD, D DRIVE, D3 AWD, D5 AWD	2,4	120/129/ 151/158	D 5244...; D5244T10; D5244T14; D5244T16; D5244T17		08.09→		<b>0 445 010 655</b>
D AWD, D5 AWD	2,4	120/136	D5244T4; D5244T5		03.09-07.09		<b>0 445 010 110</b>
<b>XC70 I</b>							
2.4 D	2,4	120	D5244T		08.02-07.06		<b>0 445 010 043 0 986 437 312</b>
D5	2,4	136	D5244T4		12.05-07.07		<b>0 445 010 110</b>
<b>XC70 II</b>							
2.0 D3 DRIVe	2,0	120	D5204T2; D5204T3		08.10→		<b>0 445 010 655</b>
2.4 D AWD, D DRIVE, D3 AWD, D5 AWD	2,4	120/129/ 151/158	D5244T10; D5244T11; D5244T14; D5244T15; D5244T16; D5244T17		08.09→		<b>0 445 010 655</b>
D AWD, D5 AWD	2,4	120/136	D5244T4; D5244T5		08.07-07.09		<b>0 445 010 110</b>
<b>XC90</b>							
2.4 D3 FWD, D5 AWD	2,4	120/136/ 147	D5244T; D5244T4; D5244T5; D5244T18		01.03→		<b>0 445 010 110</b>





**VW (VOLKSWAGEN)**

**Amarok**

2.0 BiTDI, BiTDI 4Motion, TDI, TDI 4Motion [2H]	2,0	90/120	CDBA <D45>; CDCA <D46>	09.10→	<b>0 445 010 543</b>	<b>0 986 437 410</b>
---	-----	--------	------------------------	--------	----------------------	----------------------

**Caddy**

2.0 TDI [2C]	2,0	81	CLCA <D96>	08.10→	<b>0 445 010 566</b>	<b>0 986 437 420</b>
TDI, TDI 4 Motion [2C]	2,0	103	CFHC <D91>; CFHE	11.10→	<b>0 445 010 551</b>	<b>0 986 437 412</b>
TDI 4 Motion [2C]	2,0	81	CFHF	08.10→	<b>0 445 010 551</b>	<b>0 986 437 412</b>

**Eos**

2.0 TDI [1F7]	2,0	103	CBAB <D91>	05.08-11.10	<b>0 445 010 546</b>	<b>0 986 437 408</b>
TDI [1F8]	2,0	100/103	CFFA <D94>; CFFB <D91>	11.10→	<b>0 445 010 551</b>	<b>0 986 437 412</b>

**Golf Plus**

2.0 TDI [521]	2,0	81	CLCA <D96>	05.10-04.11	<b>0 445 010 566</b>	<b>0 986 437 420</b>
		81/100/103	CBDA <D94>; CBDB <D91>; CBDC <D96>	01.09-05.10	<b>0 445 010 546</b>	<b>0 986 437 408</b>
		100	CFHB <D94>	11.09-04.11	<b>0 445 010 551</b>	<b>0 986 437 412</b>
				05.11→	<b>0 445 010 562</b>	
		103	CFHC <D91>	11.09-04.11	<b>0 445 010 551</b>	<b>0 986 437 412</b>
				05.11→	<b>0 445 010 562</b>	

**Golf V Variant**

2.0 TDI [1K5]	2,0	100/103	CBDA; CBDB	07.08-07.09	<b>0 445 010 546</b>	<b>0 986 437 408</b>
---------------	-----	---------	------------	-------------	----------------------	----------------------

**Golf VI**

2.0 TDI [5K1]	2,0	81	CLCA <D96>	05.10→	<b>0 445 010 566</b>	<b>0 986 437 420</b>
		103	CJAA <D91>	09.09→	<b>0 445 010 543</b>	<b>0 986 437 410</b>
TDI, TDI 4 Motion [5K1]	2,0	81/100/103/125	CBAA <D94>; CBAB <D91>; CBDB <D93>; CBDC <D96>	10.08-05.10	<b>0 445 010 546</b>	<b>0 986 437 408</b>
		100/103/125	CFFA <D94>; CFFB <D91>; CFGB <D93>	11.09→	<b>0 445 010 551</b>	<b>0 986 437 412</b>

**Golf VI Cabrio**

2.0 TDI [517]	2,0	103	CFHC <D91>	11.11→	<b>0 445 010 551</b>	<b>0 986 437 412</b>
---------------	-----	-----	------------	--------	----------------------	----------------------

**Golf VI Variant**

2.0 TDI [AJ5]	2,0	81	CLCA <D96>	01.10-10.11	TW	<b>0 445 010 562</b>
				01.10→	TW	<b>0 445 010 566</b>
				12.10→	TW	<b>0 445 010 565</b>
		100	CBDA <D91>	07.09-09.10		<b>0 445 010 546</b>
			CFHB <D94>	07.10-10.11	TW	<b>0 445 010 562</b>
				07.10→	TW	<b>0 445 010 551</b>
		103	CBDB <D91>	07.09-10.11		<b>0 445 010 546</b>
				11.11→		<b>0 445 010 543</b>
			CFHC <D91>	07.09-10.11	TW	<b>0 445 010 562</b>
				07.09→	TW	<b>0 445 010 551</b>

**Jetta**

2.0 TDI [1K2]	2,0	81	CLCA <D96>	01.10-10.10	EU4	<b>0 445 010 566</b>
					EU5	<b>0 445 010 551</b>
		100/103/125	CBDA <D94>; CBDB <D91>; CEGA <D93>	07.08-10.10		<b>0 445 010 546</b>
TDI [162]	2,0	103	CFFB <D91>	10.10→	EU4	<b>0 445 010 566</b>
					EU5	<b>0 445 010 551</b>
			CLCB <D91>	10.10→	EU4	<b>0 445 010 566</b>
					EU5	<b>0 445 010 551</b>

**Jetta SportWagen**

2.0 TDI [1K5]	2,0	103	CBEA	04.08→		<b>0 445 010 546</b>
---------------	-----	-----	------	--------	--	----------------------

**Passat**

2.0 TDI [362]	2,0	100	CFFA <D94>	08.10→	EU3,EU5,EU6	<b>0 445 010 560</b>
					EU4	<b>0 445 010 565</b>
		125	CLLA	11.10→	EU3,EU5,EU6	<b>0 445 010 560</b>
					EU4	<b>0 445 010 565</b>





◀ VW

2.0 TDI, TDI 4 Motion [3C2]	2,0	81/100/103/105/125	CBA <D94>; CBAB <D91>; CBAC <D92>; CBBB <D93>; CBDC <D96>	05.08-11.10		0 445 010 546	0 986 437 408
TDI, TDI 4 Motion [362]	2,0	103	CFFB <D91>	08.10→	EU3,EU5, EU6	0 445 010 560	
					EU4	0 445 010 565	
		125	CFGB <D93>	08.10→	EU3,EU5, EU6	0 445 010 560	
					EU4	0 445 010 565	

**Passat CC**

2.0 TDI [357]	2,0	100	CFFA <D94>	11.10→	EU3,EU5, EU6	0 445 010 560	
					EU4	0 445 010 565	
TDI, TDI 4 Motion [357]	2,0	100/103/105/125	CBA <D94>; CBAB <D91>; CBAC; CBBB <D93>	05.08-11.10		0 445 010 546	0 986 437 408
		103	CFFB <D91>	11.10→	EU3,EU5, EU6	0 445 010 560	
					EU4	0 445 010 565	
		125	CFGB <D93>	11.10→	EU3,EU5, EU6	0 445 010 560	
					EU4	0 445 010 565	

**Passat Variant**

2.0 TDI [365]	2,0	100	CFFA <D94>	08.10→	EU3,EU5, EU6	0 445 010 560	
					EU4	0 445 010 565	
		103	CFFB <D91>	08.10→	EU3,EU5, EU6	0 445 010 560	
					EU4	0 445 010 565	
		125	CFGB <D93>	08.10→	EU3,EU5, EU6	0 445 010 560	
					EU4	0 445 010 565	
TDI, TDI 4 Motion [3C5]	2,0	81/100/103/105/125	CBA <D94>; CBAB <D91>; CBAC <D92>; CBBB <D93>; CBDC <D96>	01.08-11.10		0 445 010 546	0 986 437 408

**Phaeton**

3.0 TDI 4 Motion [3D]	3,0	165	BMK	09.04-05.07		0 445 010 343	0 986 437 348
		171/176	CARA; CEXA <D50>	06.07→		0 445 010 673	

**Scirocco**

2.0 TDI [137]	2,0	100/103/125	CFGB <D93>; CFHB <D94>; CFHC <D91>	11.10→		0 445 010 551	0 986 437 412
		103/125	CBBB <D93>; CBDB <D91>	10.08-11.10		0 445 010 546	0 986 437 408

**Sharan**









2.0 TDI [7N1]	2,0	125	CFGB <D93>	08.10-05.11		0 445 010 560	
				06.11→		0 445 010 567	
TDI, TDI 4 Motion [7N1]	2,0	100	CFFA <D94>	05.10-05.11		0 445 010 560	
				06.11→		0 445 010 567	
		103	CFFB <D91>	05.10-05.11		0 445 010 560	
				06.11→		0 445 010 567	

**Tiguan**

2.0 TDI, TDI 4 Motion [5N1]	2,0	81/100/103/125	CFFA <D94>; CFFB <D91>; CFFD <D96>; CFGB <D93>; CLJA <D91>	11.09-05.11		0 445 010 551	0 986 437 412
		100/103/120/125	CBA <D94>; CBAB <D91>; CBBA <D95>; CBBB <D93>	11.07-05.11		0 445 010 546	0 986 437 408

**Touareg**

3.0 TDI [7LA]	3,0	155	BUN	04.06-11.06		0 445 010 331	0 986 437 093
		165	BKS				
			Fg.Nr. →7L..6..040 000	11.04-11.05		0 445 010 343	0 986 437 348
			Fg.Nr. 7L..6..040 001→	12.05-11.06		0 445 010 331	0 986 437 093
TDI [7L6]	3,0	155	CASB	11.07-04.10		0 445 010 669	0 986 437 404
				05.10-05.10		0 445 010 673	
		155/165	BKS; BUN	12.06-05.08		0 445 010 331	0 986 437 093
		165	CATA	05.09-04.10		0 445 010 654	
				05.10-05.10		0 445 010 673	

								
<b>3.0 TDI [7L6]</b>	3,0	176	CASA		11.07-04.10		<b>0 445 010 669</b>	<b>0 986 437 404</b>
					05.10-05.10		<b>0 445 010 673</b>	
			CASC		01.08-04.10		<b>0 445 010 669</b>	<b>0 986 437 404</b>
					05.10-05.10		<b>0 445 010 673</b>	
TDI [7P5]	3,0	150/176	CASA <D50>; CASD <D1Q>		01.10-05.11		<b>0 445 010 669</b>	<b>0 986 437 404</b>
		150/180	CJMA; CRCA		05.11→		<b>0 445 010 658</b>	
<b>Touran</b>								
<b>2.0 TDI [1T3]</b>	2,0	81	CLCA <D96>		05.10→		<b>0 445 010 566</b>	<b>0 986 437 420</b>
		103/125	CFHC <D91>; CFJA <D93>		05.10→		<b>0 445 010 551</b>	<b>0 986 437 412</b>





**AMUR (AUTOM.AND MOTOR OF URAL)**

<b>10t</b>						
531320	4,8	100	D 245.9 E3 <Euro 3>		01.08→	0 445 020 088
<b>11t</b>						
341240	4,8	111,4	D 245.30 E3 <Euro 3>		04.09→	0 445 020 088
541340	4,8	111,4	D 245.30 E3 <Euro 3>		04.09→	0 445 020 088

**CITROEN**

<b>Jumper</b>						
2.0 HDi [U5]	2,0	62	RHV <DW10TD>		02.02-05.06	0 445 010 046 0 986 437 017
HDi [23]	2,0	62	RHV <DW10TD>		03.01-02.02	0 445 010 046 0 986 437 017
2.2 HDi [U5]	2,2	74	4HY <DW12TED>		02.02-05.06	0 445 010 046 0 986 437 017
2.8 HDi [U5]	2,8	94	8140 43s <SOFIM 2800 HDi>		02.02-05.06	0 445 020 002 0 986 437 501
HDi [23]	2,8	94	8140 43s <SOFIM 2800 HDi>		09.00-02.02	0 445 020 002 0 986 437 501
HDI	2,8	93	8140 43s		09.05-09.09	0 445 020 002 0 986 437 501

**DAF**

<b>CF</b>						
65 .180, .220, .250	5,9	136/162/184	CE 136 <Euro3>; CE 162 <Euro3>; CE 184 C <Euro3>		01.01-01.07	0 445 020 007 0 986 437 341
.220, .250	6,7	165/184	GR 165 <Euro 4/5/EEV>; GR 184 <Euro 4/5>		04.06→ TW	0 445 020 045 0 986 437 342
.280	6,7	210	GR 210 <Euro 4>		04.07→	0 445 020 045 0 986 437 342
<b>LF</b>						
45 .130, .180	5,9	99/136	BE 99 <Euro 3>; CE 136 C <Euro 3>		07.01-12.08	0 445 020 007 0 986 437 341
.140, .160, .180	4,5	103/118/136	FR 103 <Euro 4/5>; FR 118 <Euro 4/5>; FR 136 <Euro 4/5>		05.06→ TW	0 445 020 045 0 986 437 342
.150	3,9	110	BE 110 C <Euro 3>		04.01-10.07	0 445 020 007 0 986 437 341
.170	3,9	123	BE 123 C <Euro 3>		04.01-12.07 TW	0 445 020 007 0 986 437 341
						0 445 020 045 0 986 437 342
.220	5,9	162	CE 162 C <Euro 3>		11.01-01.09 TW	0 445 020 007 0 986 437 341
						0 445 020 045 0 986 437 342
.220, .250	6,7	165/184	GR 165 <Euro 4/5>; GR 184 <Euro 4/5>		09.06→ TW	0 445 020 045 0 986 437 342
55 .180	4,5	136	FR 136 <Euro 4/5>		04.06→ TW	0 445 020 045 0 986 437 342
	5,9	136	CE 136 C		04.01-08.08	0 445 020 007 0 986 437 341
.220	5,9	162	CE 162 C		04.01-08.08 TW	0 445 020 007 0 986 437 341
						0 445 020 045 0 986 437 342
.220, .250, .280	6,7	165/184/210	GR 165 <Euro 4/5>; GR 184 <Euro 4/5>; GR 210 <Euro 4/5>		04.06→ TW	0 445 020 045 0 986 437 342
.250	5,9	184	CE 184 C		04.01-08.08 TW	0 445 020 007 0 986 437 341
						0 445 020 045 0 986 437 342

**DODGE**

<b>Sprinter 2500</b>						
2.7 [VA]	2,7	115	OM 612		01.03-12.03	0 445 010 270 0 986 437 102

**FIAT**

<b>Ducato</b>						
2.0 JTD [250..]	2,0	85			06.11→	0 445 010 306
3.0 JTD [250..]	3,0	130	F1CE348IE		06.11→	0 445 010 545
<b>Ducato Cargo</b>						
2.8 JTD	2,8	93	8140.43S		06.05-08.09	0 445 020 002 0 986 437 501
<b>Ducato Combinato</b>						
2.8 JTD	2,8	93	8140.43S		06.05-08.09	0 445 020 002 0 986 437 501





<b>Ducato Minibus</b>							
2.8 JTD	2,8	93	8140.43S		06.05-08.09	0 445 020 002	0 986 437 501
<b>Ducato Multi</b>							
2.8 JTD	2,8	93	8140.43S		06.05-08.09	0 445 020 002	0 986 437 501
<b>Ducato 10</b>							
2.0 JTD [230..]	2,0	63	RHV <M15>		10.01-03.02	0 445 010 046	0 986 437 017
2.8 JTD EGR 4x4, JTD 4x4 [234..]	2,8	94	8140.43S <M13>; 8140.43S <M14>		08.00-03.02	0 445 020 002	0 986 437 501
JTD, JTD EGR [230..]	2,8	94	8140.43S <M13>; 8140.43S <M14>		08.00-03.02	0 445 020 002	0 986 437 501
<b>Ducato 11</b>							
2.0 JTD [243..]	2,0	62	RHV <M5>		04.02-08.06	0 445 010 046	0 986 437 017
2.3 JTD [243..]	2,3	81	F1AE0481C <M10>		04.02-08.06	0 445 020 008	0 986 437 318
					01.08→	0 445 010 181	0 986 437 085
JTD [250..]	2,3	88/96	F1AE0481D <M94>; F1AE0481N <M95>		06.06→	0 445 010 137	0 986 437 085
JTD EGR [243..]	2,3	81	F1AE0481C <M11>		04.02-08.06	0 445 020 008	0 986 437 318
2.8 JTD EGR 4x4, JTD 4x4 [247..]	2,8	94	8140.43S <M15>; 8140.43S <M20>		04.02-08.06	0 445 020 002	0 986 437 501
JTD, JTD EGR [243..]	2,8	94	8140.43S <M15>; 8140.43S <M20>		04.02-08.06	0 445 020 002	0 986 437 501
3.0 JTD [250..]	3,0	116	F1CE0481D <M96>		06.06→	0 445 020 046	
<b>Ducato 14</b>							
2.0 JTD [231..]	2,0	63	RHV <M15>		10.01-03.02	0 445 010 046	0 986 437 017
2.8 JTD EGR 4x4, JTD 4x4 [234..]	2,8	94	8140.43S <M13>; 8140.43S <M14>		08.00-03.02	0 445 020 002	0 986 437 501
JTD, JTD EGR [231..]	2,8	94	8140.43S <M13>; 8140.43S <M14>		08.00-03.02	0 445 020 002	0 986 437 501
<b>Ducato 15</b>							
2.0 JTD [244..]	2,0	62	RHV <M5>		04.02-08.06	0 445 010 046	0 986 437 017
2.3 JTD [244..]	2,3	81	F1AE0481C <M10>		04.02-08.06	0 445 020 008	0 986 437 318
					01.08→	0 445 010 181	0 986 437 085
JTD [250..]	2,3	88/96	F1AE0481D <M94>; F1AE0481N <M95>		06.06→	0 445 010 137	0 986 437 085
JTD EGR [244..]	2,3	81	F1AE0481C <M11>		04.02-08.06	0 445 020 008	0 986 437 318
					01.08→	0 445 010 181	0 986 437 085
2.8 JTD CGV [244..]	2,8	107	8140.43S <M22>		04.04-08.06	0 445 020 006	0 986 437 502
JTD EGR 4x4, JTD 4x4 [247..]	2,8	94	8140.43S <M15>; 8140.43S <M20>		04.02-08.06	0 445 020 002	0 986 437 501
JTD, JTD EGR [244..]	2,8	94	8140.43S <M15>; 8140.43S <M20>		04.02-08.06	0 445 020 002	0 986 437 501
3.0 JTD [250..]	3,0	116	F1CE0481D <M96>		06.06→	0 445 020 046	
<b>Ducato 17</b>							
2.3 JTD [250..]	2,3	88/96	F1AE0481D <M94>; F1AE0481N <M95>		06.06→	0 445 010 137	0 986 437 085
JTD Maxi [251..]	2,3	88/96	F1AE0481D <M94>; F1AE0481N <M95>		06.06→	0 445 010 137	0 986 437 085
3.0 JTD [250..]	3,0	116	F1CE0481D <M96>		06.06→	0 445 020 046	
JTD Maxi [251..]	3,0	116	F1CE0481D <M96>		06.06→	0 445 020 046	
<b>Ducato 18</b>							
2.3 JTD [245..]	2,3	81	F1AE0481C <M10>		04.02-08.06	0 445 020 008	0 986 437 318
					01.08→	0 445 010 181	0 986 437 085
JTD EGR [245..]	2,3	81	F1AE0481C <M11>		01.08→	0 445 010 181	0 986 437 085
2.8 JTD CGV [245..]	2,8	107	8140.43S <M22>		04.04-08.06	0 445 020 006	0 986 437 502
JTD EGR 4x4, JTD 4x4 [234..]	2,8	94	8140.43S <M13>; 8140.43S <M14>		08.00-03.02	0 445 020 002	0 986 437 501
JTD EGR 4x4, JTD 4x4 [247..]	2,8	94	8140.43S <M15>; 8140.43S <M20>		04.02-08.06	0 445 020 002	0 986 437 501
JTD, JTD EGR [232..]	2,8	94	8140.43S <M13>; 8140.43S <M14>		08.00-03.02	0 445 020 002	0 986 437 501
JTD, JTD EGR [245..]	2,8	94	8140.43S <M15>; 8140.43S <M20>		04.02-08.06	0 445 020 002	0 986 437 501
<b>Ducato 20</b>							
2.3 JTD Maxi [251..]	2,3	88/96	F1AE0481D <M94>; F1AE0481N <M95>		06.06→	0 445 010 137	0 986 437 085
3.0 JTD [251..]	3,0	107/115	F1CE3481M <M99>; F1CE3481N <M97>		09.10→	0 445 010 545	
JTD Maxi [251..]	3,0	116	F1CE0481D <M96>		06.06→	0 445 020 046	

FORD

<b>Cargo Ford-Otosan</b>							
Cargo 1830, 2524, 2530, 3230	0,0	177/221	ECOTORQ 240 <Euro 3>; ECOTORQ 300 <Euro 3>		08.03-11.06	0 445 020 019	
<b>Serie F</b>							
250 4x4	3,9	149	4BTAA <MaxPower>		04.06-07.09	0 445 020 007	0 986 437 341
					08.09-02.12	0 445 020 123	





**GALICH CRANE PLANT**

<b>50t</b>					
KS-64713-2	11,1	303	650.10 <Euro 3>	01.10→	0 445 020 086

**GAZ**

<b>Gazel</b>					
2.7 TD	2,7	80	ADCR110 <Euro 4>	01.07→	0 445 010 177
2.8 TD	2,8	88,3/ 102,7	ISF 2.8s3129T <Euro 3>; ISF 2.8s3148T <Euro 3>	08.10→	0 445 020 119
<b>Sadko</b>					
4.8 TD 4x4	4,8	90	D 245.7 E3 <Euro 3>; D 245.7 E4 <Euro 4>	01.08→	0 445 020 088
<b>Sobol</b>					
2.8 TD	2,8	88,3/ 102,7	ISF 2.8s3129T <Euro 3>; ISF 2.8s3148T <Euro 3>	08.10→	0 445 020 119
<b>Valday</b>					
3.8 TD	3,8	125	ISF 3.8 <Euro 3>	12.11→	0 445 020 045 0 986 437 342
4.8 TD	4,8	90	D 245.7 E3 <Euro 3>; D 245.7 E4 <Euro 4>	01.08→	0 445 020 088
<b>3309</b>					
4.8 TD	4,8	90	D 245.7 E3 <Euro 3>; D 245.7 E4 <Euro 4>	01.08→	0 445 020 088

**HYUNDAI**

<b>H-1</b>					
2.5 CRDi	2,5	103	D4CB	08.03-05.04	0 445 010 354
				06.04-12.06	0 445 010 355
CRDi Cargo, CRDi Travel	2,5	125	D4CB <2.5L A>	03.08-05.08	0 445 010 118 0 986 437 029
<b>Starex</b>					
2.5 CRDi	2,5	103	D4CB	10.02-05.04	0 445 010 354
				06.04-01.07	0 445 010 355

**IVECO**

<b>CityClass</b>					
2.8	2,8	92	8140.43S	10.05-07.07	0 445 020 002 0 986 437 501
<b>Daily</b>					
29L9, 13 [00]	2,8	66/92	8140.43R.43...; 8140.43S...	10.00-03.06	0 445 020 002 0 986 437 501
10, 12, 14 [00]	2,3	70/85/ 100	F1AE0481A...; F1AE0481B...; F1AE0481M...	09.02-03.06	0 445 020 008 0 986 437 318
10, 12, 14 [06]	2,3	71/85/ 100	F1AE0481F...; F1AE0481G...; F1AE0481H...	04.06→	0 445 010 181 0 986 437 085
35C9 [00]	2,8	66	8140.43R...	08.01-09.04	0 445 020 002 0 986 437 501
10, 12, 14 [00]	2,3	70/85/ 100	F1AE0481A*...; F1AE0481B...; F1AE0481M...	09.02-03.06	0 445 020 008 0 986 437 318
10, 12, 14 [06]	2,3	71/85/ 100	F1AE0481F...; F1AE0481G...; F1AE0481H...; F1AE0481R...	04.06→	0 445 010 181 0 986 437 085
11, 13 [00]	2,8	78/92	8140.43B.43...; 8140.43S...	05.99-09.04	0 445 020 002 0 986 437 501
11, 13 [09]	2,3	78/93	F1AE0481U...; F1AE0481V...	06.09→	0 445 010 181 0 986 437 085
14, 17 [00]	3,0	100/122	F1CE0481A...; F1CE0481B...	09.04-03.06	0 445 010 098
14, 17 [09]	3,0	103/125	F1CE3481C...; F1CE3481L...	06.09→	0 445 010 545
15 [00]	2,8	108	8140.43N.43...	05.01-09.04	0 445 020 040
15, 18 [06]	3,0	107/130	F1CE0481F...; F1CE0481H...	04.06→	0 445 020 046
35S9 [00]	2,8	66	8140.43R...	08.01-03.06	0 445 020 002 0 986 437 501
10, 12, 14 [00]	2,3	70/85/ 100	F1AE0481A...; F1AE0481B...; F1AE0481M...	09.02-03.06	0 445 020 008 0 986 437 318
10, 12, 14 [06]	2,3	71/85/ 100	F1AE0481F...; F1AE0481G...; F1AE0481H...; F1AE0481R...	04.06→	0 445 010 181 0 986 437 085
11, 13 [00]	2,8	78/92	8140.43B.43...; 8140.43S...	05.99-03.06	0 445 020 002 0 986 437 501







<b>35 S</b> 11, 13 [09]	2,3	78/93	F1AE0481U...; F1AE0481V...	06.09→	<b>0 445 010 181</b>	<b>0 986 437 085</b>
14, 17 [00]	3,0	100/122	F1CE0481A...; F1CE0481B...	09.04-03.06	<b>0 445 010 098</b>	
14, 17 [09]	3,0	103/125	F1CE3481C...; F1CE3481L...	06.09→	<b>0 445 010 545</b>	
15 [00]	2,8	108	8140.43N.43...	05.01-03.06	<b>0 445 020 040</b>	
15, 18 [06]	3,0	107/130	F1CE0481F...; F1CE0481H...	05.01-09.06	<b>0 445 020 040</b>	
18 [09]	3,0	130	F1CE3481H...	04.06-05.09	<b>0 445 020 046</b>	
<b>40 C</b> 10, 12 [06]	2,3	71/85	F1AE0481F...; F1AE0481G...	11.10→	<b>0 445 020 046</b>	
11, 13 [09]	2,3	78/93	F1AE0481U...; F1AE0481V...	04.06-05.09	<b>0 445 010 181</b>	<b>0 986 437 085</b>
13 [00]	2,8	92	8140.43S...	06.09→	<b>0 445 010 181</b>	<b>0 986 437 085</b>
14, 17 [00]	3,0	100/122	F1CE0481A...; F1CE0481B...	01.01-09.04	<b>0 445 020 002</b>	<b>0 986 437 501</b>
14, 17 [09]	3,0	103/125	F1CE3481C...; F1CE3481CC...	09.04-03.06	<b>0 445 010 098</b>	
15 [00]	2,8	108	8140.43N.43...	06.09→	<b>0 445 010 545</b>	
15, 18 [06]	3,0	107/130	F1CE0481...; F1CE0481H...	04.03-09.04	<b>0 445 020 040</b>	
<b>45 C</b> 13 [00]	2,8	92	8140.43S...	04.06→	<b>0 445 020 046</b>	
15, 18 [06]	3,0	107/130	F1CE0481F...; F1CE0481H...	01.01-09.04	<b>0 445 020 002</b>	<b>0 986 437 501</b>
<b>50 C</b> 11, 13 [00]	2,8	78/92	8140.43B.43...; 8140.43S...	04.06→	<b>0 445 020 046</b>	
12 [00]	2,3	85	F1AE0481B...	05.99-09.04	<b>0 445 020 002</b>	<b>0 986 437 501</b>
12 [06]	2,3	85	F1AE0481G...	09.02-03.06	<b>0 445 020 008</b>	<b>0 986 437 318</b>
14, 17 [00]	3,0	100/122	F1CE0481A...; F1CE0481B...	04.06→	<b>0 445 010 181</b>	<b>0 986 437 085</b>
14, 17 [09]	3,0	103/125	F1CE3481C...; F1CE3481L...	09.04-03.06	<b>0 445 010 098</b>	
15 [00]	2,8	108	8140.43N.43...	06.09→	<b>0 445 010 545</b>	
15, 18 [06]	3,0	107/130	F1CE0481F...; F1CE0481H...	05.01-09.04	<b>0 445 020 040</b>	
<b>55 S</b> 17 [09]	3,0	125	F1CE3481CC...	04.06→	<b>0 445 020 046</b>	
18 [06]	3,0	130	F1CE0481H...	06.09→	<b>0 445 010 545</b>	
<b>60 C</b> 15, 18 [06]	3,0	107/130	F1CE0481F...; F1CE0481H...	04.06→	<b>0 445 020 046</b>	
<b>65 C</b> 13, 15 [00]	2,8	108	8140.43N.43...	05.00-09.04	<b>0 445 020 040</b>	
14, 17 [00]	3,0	100/122	F1CE0481A...; F1CE0481B...	09.04-03.06	<b>0 445 010 098</b>	
14, 17 [09]	3,0	103/125	F1CE3481C...; F1CE3481L...	06.09→	<b>0 445 010 545</b>	
15, 18 [06]	3,0	107/130	F1CE0481F...; F1CE0481H...	04.06→	<b>0 445 020 046</b>	
<b>70 C</b> 14, 17 [09]	3,0	103/125	F1CE3481C...; F1CE3481L...	11.10→	<b>0 445 010 545</b>	
15, 18 [09]	3,0	107/130	F1CE3481F...; F1CE3481H...	06.10→	<b>0 445 020 046</b>	
<b>Daily Chassi</b>						
<b>35</b> .13	2,8	92	8140.43S	10.05-07.07	<b>0 445 020 002</b>	<b>0 986 437 501</b>
<b>35 S</b> 14	3,0	100	F1CE0481 <Euro 3>	08.07→	<b>0 445 020 046</b>	
<b>40</b> .13	2,8	92	8140.43S	10.05-07.07	<b>0 445 020 002</b>	<b>0 986 437 501</b>
<b>50</b> .13	2,8	92	8140.43S	10.05-07.07	<b>0 445 020 002</b>	<b>0 986 437 501</b>
<b>55 C</b> 16	3,0	114	F1CE0481 <Euro 3>	08.07→	<b>0 445 020 046</b>	
<b>70</b> .13	2,8	92	8140.43S	10.05-07.07	<b>0 445 020 002</b>	<b>0 986 437 501</b>
<b>Daily Furgao</b>						
<b>35 S</b> 14	3,0	100	F1CE0481 <Euro 3>	08.07→	<b>0 445 020 046</b>	
<b>38</b> .13	2,8	92	8140.43S	10.05-07.07	<b>0 445 020 002</b>	<b>0 986 437 501</b>
<b>40</b> .13	2,8	92	8140.43S	10.05-07.07	<b>0 445 020 002</b>	<b>0 986 437 501</b>
<b>50</b> .13	2,8	92	8140.43S	10.05-07.07	<b>0 445 020 002</b>	<b>0 986 437 501</b>
<b>55 C</b> 16	3,0	114	F1CE0481 <Euro 3>	08.07→	<b>0 445 020 046</b>	
<b>Daily MaxiVan</b>						
<b>40</b> .13	2,8	92	8140.43S	10.05-07.07	<b>0 445 020 002</b>	<b>0 986 437 501</b>
<b>40 S</b> 16	3,0	114	F1CE0481 <Euro 3>	08.07→	<b>0 445 020 046</b>	
<b>55 C</b> 16	3,0	114	F1CE0481 <Euro 3>	08.07→	<b>0 445 020 046</b>	
<b>EuroCargo</b>						
<b>60 E</b> 14 [03]	3,9	103	F4AE3481C*S...			
			Mot.Nr. →804621	05.09→	<b>0 445 020 007</b>	<b>0 986 437 341</b>
			Mot.Nr. 804622→	05.09→	<b>0 445 020 175</b>	
16 [03]	3,9	118	F4AE3481D*S...			
			Mot.Nr. →804621	05.09→	<b>0 445 020 007</b>	<b>0 986 437 341</b>
			Mot.Nr. 804622→	05.09→	<b>0 445 020 175</b>	
<b>65 E</b> 13	3,9	95	F4AE0481D*C...			
			Mot.Nr. →804621	08.00-08.03	<b>0 445 020 007</b>	<b>0 986 437 341</b>
			Mot.Nr. 804622→	08.00-08.03	<b>0 445 020 175</b>	
13 [03]	3,9	95	F4AE0481D*C...			
			Mot.Nr. →804621	09.03-08.05	<b>0 445 020 007</b>	<b>0 986 437 341</b>
			Mot.Nr. 804622→	09.03-08.05	<b>0 445 020 175</b>	





◀ IVECO

65 E 14 [03]	3,9	103	F4AE3481C*P...				
			Mot.Nr. →804621	09.04-08.06	0 445 020 007	0 986 437 341	
			Mot.Nr. 804622→	09.04-08.06	0 445 020 175		
15	3,9	110	F4AE0481C*C...				
			Mot.Nr. →804621	08.00-08.03	0 445 020 007	0 986 437 341	
			Mot.Nr. 804622→	08.00-08.03	0 445 020 175		
15 [03]	3,9	110	F4AE0481C*C...				
			Mot.Nr. →804621	09.03-08.05	0 445 020 007	0 986 437 341	
			Mot.Nr. 804622→	09.03-08.05	0 445 020 175		
16 [03]	3,9	118	F4AE3481D*P...				
			Mot.Nr. →804621	09.04-08.06	0 445 020 007	0 986 437 341	
			Mot.Nr. 804622→	09.04-08.06	0 445 020 175		
75 E 13	3,9	95	F4AE0481D*...				
			Mot.Nr. →804621	09.00-08.03	0 445 020 007	0 986 437 341	
			Mot.Nr. 804622→	09.00-08.03	0 445 020 175		
13 [03]	3,9	95	F4AE0481D*C...				
			Mot.Nr. →804621	09.03-08.05	0 445 020 007	0 986 437 341	
			Mot.Nr. 804622→	09.03-08.05	0 445 020 175		
14 [03]	3,9	103	F4AE3481C*...				
			Mot.Nr. →804621	09.05→	0 445 020 007	0 986 437 341	
			Mot.Nr. 804622→	09.05→	0 445 020 175		
15	3,9	110	F4AE0481C*...				
			Mot.Nr. →804621	09.00-08.03	0 445 020 007	0 986 437 341	
			Mot.Nr. 804622→	09.00-08.03	0 445 020 175		
15 [03]	3,9	110	F4AE0481C*C...				
			Mot.Nr. →804621	09.03-08.05	0 445 020 007	0 986 437 341	
			Mot.Nr. 804622→	09.03-08.05	0 445 020 175		
16 [03]	3,9	118	F4AE3481D*...				
			Mot.Nr. →804621	09.05→	0 445 020 007	0 986 437 341	
			Mot.Nr. 804622→	09.05→	0 445 020 175		
17	3,9	125	F4AE0481A*C...				
			Mot.Nr. →804621	09.00-08.03	0 445 020 007	0 986 437 341	
			Mot.Nr. 804622→	09.00-08.03	0 445 020 175		
17 [03]	3,9	125	F4AE0481A*C...				
			Mot.Nr. →804621	09.03-08.05	0 445 020 007	0 986 437 341	
			Mot.Nr. 804622→	09.03-08.05	0 445 020 175		
18	5,9	134	F4AE0681E*C...				
			Mot.Nr. →804621	09.00-08.03	0 445 020 007	0 986 437 341	
			Mot.Nr. 804622→	09.00-08.03	0 445 020 175		
18 [03]	3,9	130	F4AE3481B*...				
			Mot.Nr. →804621	09.05→	0 445 020 007	0 986 437 341	
			Mot.Nr. 804622→	09.05→	0 445 020 175		
80 E 15	3,9	110	F4AE0481C*C...				
			Mot.Nr. →804621	09.00-08.03	0 445 020 007	0 986 437 341	
			Mot.Nr. 804622→	09.00-08.03	0 445 020 175		
15 [03]	3,9	110	F4AE0481C*C...				
			Mot.Nr. →804621	09.03-08.05	0 445 020 007	0 986 437 341	
			Mot.Nr. 804622→	09.03-08.05	0 445 020 175		
16 [03]	3,9	118	F4AE3481D*...				
			Mot.Nr. →804621	09.05→	0 445 020 007	0 986 437 341	
			Mot.Nr. 804622→	09.05→	0 445 020 175		
17	3,9	125	F4AE0481A*C...				
			Mot.Nr. →804621	09.00-08.03	0 445 020 007	0 986 437 341	
			Mot.Nr. 804622→	09.00-08.03	0 445 020 175		





<b>80 E 17 [03]</b>	3,9	125	F4AE0481A*C...				
			Mot.Nr. →804621	09.03-08.05	<b>0 445 020 007</b>	<b>0 986 437 341</b>	
			Mot.Nr. 804622→	09.03-08.05		<b>0 445 020 175</b>	
18	5,9	134	F4AE0681E*C...				
			Mot.Nr. →804621	09.00-08.03	<b>0 445 020 007</b>	<b>0 986 437 341</b>	
			Mot.Nr. 804622→	09.00-08.03		<b>0 445 020 175</b>	
18 [03]	3,9	130	F4AE3481B...				
			Mot.Nr. →804621	09.05→	<b>0 445 020 007</b>	<b>0 986 437 341</b>	
			Mot.Nr. 804622→	09.05→		<b>0 445 020 175</b>	
	5,9	134	F4AE0681E*C...				
			Mot.Nr. →804621	09.03-08.05	<b>0 445 020 007</b>	<b>0 986 437 341</b>	
			Mot.Nr. 804622→	09.03-08.05		<b>0 445 020 175</b>	
21	5,9	154	F4AE0681D*C...				
			Mot.Nr. →804621	09.00-08.03	<b>0 445 020 007</b>	<b>0 986 437 341</b>	
			Mot.Nr. 804622→	09.00-08.03		<b>0 445 020 175</b>	
21 [03]	5,9	154	F4AE0681D*C...				
			Mot.Nr. →804621	09.03-08.05	<b>0 445 020 007</b>	<b>0 986 437 341</b>	
			Mot.Nr. 804622→	09.03-08.05		<b>0 445 020 175</b>	
22 [03]	5,9	160	F4AE3681B...				
			Mot.Nr. →804621	09.05→	<b>0 445 020 007</b>	<b>0 986 437 341</b>	
			Mot.Nr. 804622→	09.05→		<b>0 445 020 175</b>	
<b>90 E 17</b>	3,9	125	F4AE0481A*C...				
			Mot.Nr. →804621	09.00-08.03	<b>0 445 020 007</b>	<b>0 986 437 341</b>	
			Mot.Nr. 804622→	09.00-08.03		<b>0 445 020 175</b>	
17 [03]	3,9	125	F4AE0481A*C...				
			Mot.Nr. →804621	09.03-09.05	<b>0 445 020 007</b>	<b>0 986 437 341</b>	
			Mot.Nr. 804622→	09.03-09.05		<b>0 445 020 175</b>	
18	5,9	134	F4AE0681E*C...				
			Mot.Nr. →804621	09.00-08.03	<b>0 445 020 007</b>	<b>0 986 437 341</b>	
			Mot.Nr. 804622→	09.00-08.03		<b>0 445 020 175</b>	
18 [03]	3,9	130	F4AE3481B...				
			Mot.Nr. →804621	09.05→	<b>0 445 020 007</b>	<b>0 986 437 341</b>	
			Mot.Nr. 804622→	09.05→		<b>0 445 020 175</b>	
	5,9	134	F4AE0681E*C...				
			Mot.Nr. →804621	09.03-09.05	<b>0 445 020 007</b>	<b>0 986 437 341</b>	
			Mot.Nr. 804622→	09.03-09.05		<b>0 445 020 175</b>	
21	5,9	154	F4AE0681D*C...				
			Mot.Nr. →804621	09.00-08.03	<b>0 445 020 007</b>	<b>0 986 437 341</b>	
			Mot.Nr. 804622→	09.00-08.03		<b>0 445 020 175</b>	
21 [03]	5,9	154	F4AE0681D*C...				
			Mot.Nr. →804621	09.03-08.05	<b>0 445 020 007</b>	<b>0 986 437 341</b>	
			Mot.Nr. 804622→	09.03-08.05		<b>0 445 020 175</b>	
22 [03]	5,9	160	F4AE3681B*...				
			Mot.Nr. →804621	09.05→	<b>0 445 020 007</b>	<b>0 986 437 341</b>	
			Mot.Nr. 804622→	09.05→		<b>0 445 020 175</b>	
<b>100 E 17</b>	3,9	125	F4AE0481A*C...				
			Mot.Nr. →804621	09.00-08.03	<b>0 445 020 007</b>	<b>0 986 437 341</b>	
			Mot.Nr. 804622→	09.00-08.03		<b>0 445 020 175</b>	
17 [03]	3,9	125	F4AE0481A*C...				
			Mot.Nr. →804621	09.03-08.05	<b>0 445 020 007</b>	<b>0 986 437 341</b>	
			Mot.Nr. 804622→	09.03-08.05		<b>0 445 020 175</b>	
18	5,9	134	F4AE0681E*C...				
			Mot.Nr. →804621	09.00-08.03	<b>0 445 020 007</b>	<b>0 986 437 341</b>	
			Mot.Nr. 804622→	09.00-08.03		<b>0 445 020 175</b>	
18 [03]	3,9	130	F4AE3481B...				
			Mot.Nr. →804621	09.06→	<b>0 445 020 007</b>	<b>0 986 437 341</b>	
			Mot.Nr. 804622→	09.06→		<b>0 445 020 175</b>	
	5,9	134	F4AE0681E*C...				
			Mot.Nr. →804621	09.03-08.05	<b>0 445 020 007</b>	<b>0 986 437 341</b>	
			Mot.Nr. 804622→	09.03-08.05		<b>0 445 020 175</b>	
		135	F4AE3681C*...				
			Mot.Nr. →804621	09.05→	<b>0 445 020 007</b>	<b>0 986 437 341</b>	
			Mot.Nr. 804622→	09.05→		<b>0 445 020 175</b>	





◀ IVECO

<b>100 E 21</b>	5,9	154	F4AE0681D*C...						
			Mot.Nr. →804621			09.00-08.03	<b>0 445 020 007</b>	<b>0 986 437 341</b>	
			Mot.Nr. 804622→			09.00-08.03	<b>0 445 020 175</b>		
21 [03]	5,9	154	F4AE0681D*C...						
			Mot.Nr. →804621			09.03-08.05	<b>0 445 020 007</b>	<b>0 986 437 341</b>	
			Mot.Nr. 804622→			09.03-08.05	<b>0 445 020 175</b>		
22 [03]	5,9	160	F4AE3681B...						
			Mot.Nr. →804621			09.05→	<b>0 445 020 007</b>	<b>0 986 437 341</b>	
			Mot.Nr. 804622→			09.05→	<b>0 445 020 175</b>		
<b>110 E 22 [03]</b>	5,9	160	F4AE3681B...						
			Mot.Nr. →804621			09.07→	<b>0 445 020 007</b>	<b>0 986 437 341</b>	
			Mot.Nr. 804622→			09.07→	<b>0 445 020 175</b>		
25 [03]	5,9	185	F4AE3681D*...						
			Mot.Nr. →804621			09.07→	<b>0 445 020 007</b>	<b>0 986 437 341</b>	
			Mot.Nr. 804622→			09.07→	<b>0 445 020 175</b>		
<b>120 E 17</b>	3,9	125	F4AE0481A*C...						
			Mot.Nr. →804621			09.00-08.03	<b>0 445 020 007</b>	<b>0 986 437 341</b>	
			Mot.Nr. 804622→			09.00-08.03	<b>0 445 020 175</b>		
17 [03]	3,9	125	F4AE0481A*C...						
			Mot.Nr. →804621			09.03-08.05	<b>0 445 020 007</b>	<b>0 986 437 341</b>	
			Mot.Nr. 804622→			09.03-08.05	<b>0 445 020 175</b>		
18	5,9	134	F4AE0681E*C...						
			Mot.Nr. →804621			09.00-08.03	<b>0 445 020 007</b>	<b>0 986 437 341</b>	
			Mot.Nr. 804622→			09.00-08.03	<b>0 445 020 175</b>		
18 [03]	3,9	134	F4AE3481A...						
			Mot.Nr. →804621			09.05→	<b>0 445 020 007</b>	<b>0 986 437 341</b>	
			Mot.Nr. 804622→			09.05→	<b>0 445 020 175</b>		
	5,9	134	F4AE0681E*C...						
			Mot.Nr. →804621			09.03-08.05	<b>0 445 020 007</b>	<b>0 986 437 341</b>	
			Mot.Nr. 804622→			09.03-08.05	<b>0 445 020 175</b>		
21	5,9	154	F4AE0681D*C...						
			Mot.Nr. →804621			09.00-08.03	<b>0 445 020 007</b>	<b>0 986 437 341</b>	
			Mot.Nr. 804622→			09.00-08.03	<b>0 445 020 175</b>		
21 [03]	5,9	154	F4AE0681D*C...						
			Mot.Nr. →804621			09.03-08.05	<b>0 445 020 007</b>	<b>0 986 437 341</b>	
			Mot.Nr. 804622→			09.03-08.05	<b>0 445 020 175</b>		
22 [03]	5,9	160	F4AE3681B...						
			Mot.Nr. →804621			09.05→	<b>0 445 020 007</b>	<b>0 986 437 341</b>	
			Mot.Nr. 804622→			09.05→	<b>0 445 020 175</b>		
24	5,9	176	F4AE0681B*C...						
			Mot.Nr. →804621			09.00-08.03	<b>0 445 020 007</b>	<b>0 986 437 341</b>	
			Mot.Nr. 804622→			09.00-08.03	<b>0 445 020 175</b>		
24 [03]	5,9	176	F4AE0681B*C...						
			Mot.Nr. →804621			09.03-08.05	<b>0 445 020 007</b>	<b>0 986 437 341</b>	
			Mot.Nr. 804622→			09.03-08.05	<b>0 445 020 175</b>		
25 [03]	5,9	185	F4AE3681D...						
			Mot.Nr. →804621			09.05→	<b>0 445 020 007</b>	<b>0 986 437 341</b>	
			Mot.Nr. 804622→			09.05→	<b>0 445 020 175</b>		
28	5,9	202	F4AE0681A*C...						
			Mot.Nr. →804621			09.00-08.03	<b>0 445 020 007</b>	<b>0 986 437 341</b>	
			Mot.Nr. 804622→			09.00-08.03	<b>0 445 020 175</b>		
28 [03]	5,9	202	F4AE0681A*C...						
			Mot.Nr. →804621			09.03-08.05	<b>0 445 020 007</b>	<b>0 986 437 341</b>	
			Mot.Nr. 804622→			09.03-08.05	<b>0 445 020 175</b>		
		205	F4AE3681E...						
			Mot.Nr. →804621			09.05→	<b>0 445 020 007</b>	<b>0 986 437 341</b>	
			Mot.Nr. 804622→			09.05→	<b>0 445 020 175</b>		
<b>120 EL 18 [03]</b>	3,9	130	F4AE3481B*P...						
			Mot.Nr. →804621			09.05→	<b>0 445 020 007</b>	<b>0 986 437 341</b>	
			Mot.Nr. 804622→			09.05→	<b>0 445 020 175</b>		
22 [03]	5,9	160	F4AE3681B...						
			Mot.Nr. →804621			05.09→	<b>0 445 020 007</b>	<b>0 986 437 341</b>	
			Mot.Nr. 804622→			05.09→	<b>0 445 020 175</b>		





<b>130 E 18</b>	5,9	134	F4AE0681E*C...				
			Mot.Nr. →804621	09.00-08.03	<b>0 445 020 007</b>	<b>0 986 437 341</b>	
			Mot.Nr. 804622→	09.00-08.03		<b>0 445 020 175</b>	
18 [03]	3,9	134	F4AE3481A*P...				
			Mot.Nr. →804621	09.05→	<b>0 445 020 007</b>	<b>0 986 437 341</b>	
			Mot.Nr. 804622→	09.05→		<b>0 445 020 175</b>	
	5,9	134	F4AE0681E*C...				
			Mot.Nr. →804621	09.03-08.05	<b>0 445 020 007</b>	<b>0 986 437 341</b>	
			Mot.Nr. 804622→	09.03-08.05		<b>0 445 020 175</b>	
21	5,9	154	F4AE0681D*C...				
			Mot.Nr. →804621	09.01-08.03	<b>0 445 020 007</b>	<b>0 986 437 341</b>	
			Mot.Nr. 804622→	09.01-08.03		<b>0 445 020 175</b>	
21 [03]	5,9	154	F4AE0681D*C...				
			Mot.Nr. →804621	09.03-08.05	<b>0 445 020 007</b>	<b>0 986 437 341</b>	
			Mot.Nr. 804622→	09.03-08.05		<b>0 445 020 175</b>	
24	5,9	176	F4AE0681B*C...				
			Mot.Nr. →804621	09.00-08.03	<b>0 445 020 007</b>	<b>0 986 437 341</b>	
			Mot.Nr. 804622→	09.00-08.03		<b>0 445 020 175</b>	
24 [03]	5,9	176	F4AE0681B*C...				
			Mot.Nr. →804621	09.03-08.05	<b>0 445 020 007</b>	<b>0 986 437 341</b>	
			Mot.Nr. 804622→	09.03-08.05		<b>0 445 020 175</b>	
25 [03]	5,9	185	F4AE3681D*...				
			Mot.Nr. →804621	09.05→	<b>0 445 020 007</b>	<b>0 986 437 341</b>	
			Mot.Nr. 804622→	09.05→		<b>0 445 020 175</b>	
28	5,9	202	F4AE0681A*C...				
			Mot.Nr. →804621	09.00-08.03	<b>0 445 020 007</b>	<b>0 986 437 341</b>	
			Mot.Nr. 804622→	09.00-08.03		<b>0 445 020 175</b>	
28 [03]	5,9	202	F4AE0681A*C...				
			Mot.Nr. →804621	09.03-08.05	<b>0 445 020 007</b>	<b>0 986 437 341</b>	
			Mot.Nr. 804622→	09.03-08.05		<b>0 445 020 175</b>	
<b>140 E 18</b>	5,9	134	F4AE0681E*C...				
			Mot.Nr. →804621	09.00-08.03	<b>0 445 020 007</b>	<b>0 986 437 341</b>	
			Mot.Nr. 804622→	09.00-08.03		<b>0 445 020 175</b>	
18 [03]	3,9	134	F4AE3481A...				
			Mot.Nr. →804621	09.05→	<b>0 445 020 007</b>	<b>0 986 437 341</b>	
			Mot.Nr. 804622→	09.05→		<b>0 445 020 175</b>	
	5,9	134	F4AE0681E*C...				
			Mot.Nr. →804621	09.03-08.05	<b>0 445 020 007</b>	<b>0 986 437 341</b>	
			Mot.Nr. 804622→	09.03-08.05		<b>0 445 020 175</b>	
21	5,9	154	F4AE0681D*C...				
			Mot.Nr. →804621	09.03-08.05	<b>0 445 020 007</b>	<b>0 986 437 341</b>	
			Mot.Nr. 804622→	09.03-08.05		<b>0 445 020 175</b>	
22 [03]	5,9	160	F4AE3681B...				
			Mot.Nr. →804621	09.05→	<b>0 445 020 007</b>	<b>0 986 437 341</b>	
			Mot.Nr. 804622→	09.05→		<b>0 445 020 175</b>	
24	5,9	176	F4AE0681B*C...				
			Mot.Nr. →804621	09.00-08.03	<b>0 445 020 007</b>	<b>0 986 437 341</b>	
			Mot.Nr. 804622→	09.00-08.03		<b>0 445 020 175</b>	
24 [03]	5,9	176	F4AE0681B*C...				
			Mot.Nr. →804621	09.03-08.05	<b>0 445 020 007</b>	<b>0 986 437 341</b>	
			Mot.Nr. 804622→	09.03-08.05		<b>0 445 020 175</b>	
25 [03]	5,9	185	F4AE3681D...				
			Mot.Nr. →804621	09.05→	<b>0 445 020 007</b>	<b>0 986 437 341</b>	
			Mot.Nr. 804622→	09.05→		<b>0 445 020 175</b>	
28 [03]	5,9	202	F4AE0681A*C...				
			Mot.Nr. →804621	09.03-08.05	<b>0 445 020 007</b>	<b>0 986 437 341</b>	
			Mot.Nr. 804622→	09.03-08.05		<b>0 445 020 175</b>	
	205		F4AE3681E...				
			Mot.Nr. →804621	09.05→	<b>0 445 020 007</b>	<b>0 986 437 341</b>	
			Mot.Nr. 804622→	09.05→		<b>0 445 020 175</b>	
<b>150 E 18</b>	5,9	134	F4AE0681E*C...				
			Mot.Nr. →804621	09.00-08.03	<b>0 445 020 007</b>	<b>0 986 437 341</b>	
			Mot.Nr. 804622→	09.00-08.03		<b>0 445 020 175</b>	





◀ IVECO

<b>150 E 18 [03]</b>	3,9	134	F4AE3481A*...				
			Mot.Nr. →804621	09.05→	<b>0 445 020 007</b>	<b>0 986 437 341</b>	
			Mot.Nr. 804622→	09.05→		<b>0 445 020 175</b>	
	5,9	134	F4AE0681E*C...				
			Mot.Nr. →804621	09.03-08.05	<b>0 445 020 007</b>	<b>0 986 437 341</b>	
			Mot.Nr. 804622→	09.03-08.05		<b>0 445 020 175</b>	
21	5,9	154	F4AE0681D*C...				
			Mot.Nr. →804621	09.01-08.03	<b>0 445 020 007</b>	<b>0 986 437 341</b>	
			Mot.Nr. 804622→	09.01-08.03		<b>0 445 020 175</b>	
21 [03]	5,9	154	F4AE0681D*C...				
			Mot.Nr. →804621	09.03-08.05	<b>0 445 020 007</b>	<b>0 986 437 341</b>	
			Mot.Nr. 804622→	09.03-08.05		<b>0 445 020 175</b>	
22 [03]	5,9	160	F4AE3681B*...				
			Mot.Nr. →804621	09.05→	<b>0 445 020 007</b>	<b>0 986 437 341</b>	
			Mot.Nr. 804622→	09.05→		<b>0 445 020 175</b>	
24	5,9	176	F4AE0681B*C...				
			Mot.Nr. →804621	09.00-08.03	<b>0 445 020 007</b>	<b>0 986 437 341</b>	
			Mot.Nr. 804622→	09.00-08.03		<b>0 445 020 175</b>	
24 [03]	5,9	176	F4AE0681B*C...				
			Mot.Nr. →804621	09.03-08.05	<b>0 445 020 007</b>	<b>0 986 437 341</b>	
			Mot.Nr. 804622→	09.03-08.05		<b>0 445 020 175</b>	
25 [03]	5,9	185	F4AE3681D*...				
			Mot.Nr. →804621	09.05→	<b>0 445 020 007</b>	<b>0 986 437 341</b>	
			Mot.Nr. 804622→	09.05→		<b>0 445 020 175</b>	
28	5,9	202	F4AE0681A*C...				
			Mot.Nr. →804621	09.00-08.03	<b>0 445 020 007</b>	<b>0 986 437 341</b>	
			Mot.Nr. 804622→	09.00-08.03		<b>0 445 020 175</b>	
28 [03]	5,9	202	F4AE0681A*C...				
			Mot.Nr. →804621	09.03-08.05	<b>0 445 020 007</b>	<b>0 986 437 341</b>	
			Mot.Nr. 804622→	09.03-08.05		<b>0 445 020 175</b>	
		205	F4AE3681E*...				
			Mot.Nr. →804621	09.05→	<b>0 445 020 007</b>	<b>0 986 437 341</b>	
			Mot.Nr. 804622→	09.05→		<b>0 445 020 175</b>	
30 [03]	5,9	220	F4AE3681A*...				
			Mot.Nr. →804621	09.05→	<b>0 445 020 007</b>	<b>0 986 437 341</b>	
			Mot.Nr. 804622→	09.05→		<b>0 445 020 175</b>	
<b>160 E 18 [03]</b>	3,9	134	F4AE3481A*...				
			Mot.Nr. →804621	09.05→	<b>0 445 020 007</b>	<b>0 986 437 341</b>	
			Mot.Nr. 804622→	09.05→		<b>0 445 020 175</b>	
21 [03]	5,9	154	F4AE0681D*C...				
			Mot.Nr. →804621	09.03-08.05	<b>0 445 020 007</b>	<b>0 986 437 341</b>	
			Mot.Nr. 804622→	09.03-08.05		<b>0 445 020 175</b>	
22 [03]	5,9	160	F4AE3681B*...				
			Mot.Nr. →804621	09.05→	<b>0 445 020 007</b>	<b>0 986 437 341</b>	
			Mot.Nr. 804622→	09.05→		<b>0 445 020 175</b>	
24 [03]	5,9	176	F4AE0681B*C...				
			Mot.Nr. →804621	09.03-08.05	<b>0 445 020 007</b>	<b>0 986 437 341</b>	
			Mot.Nr. 804622→	09.03-08.05		<b>0 445 020 175</b>	
25 [03]	5,9	185	F4AE3681D*...				
			Mot.Nr. →804621	09.05→	<b>0 445 020 007</b>	<b>0 986 437 341</b>	
			Mot.Nr. 804622→	09.05→		<b>0 445 020 175</b>	
28 [03]	5,9	202	F4AE0681A*C...				
			Mot.Nr. →804621	09.03-08.05	<b>0 445 020 007</b>	<b>0 986 437 341</b>	
			Mot.Nr. 804622→	09.03-08.05		<b>0 445 020 175</b>	
		205	F4AE3681E*...				
			Mot.Nr. →804621	09.05→	<b>0 445 020 007</b>	<b>0 986 437 341</b>	
			Mot.Nr. 804622→	09.05→		<b>0 445 020 175</b>	
30 [03]	5,9	220	F4AE3681A*...				
			Mot.Nr. →804621	09.05→	<b>0 445 020 007</b>	<b>0 986 437 341</b>	
			Mot.Nr. 804622→	09.05→		<b>0 445 020 175</b>	
<b>180 E 21</b>	5,9	154	F4AE0681D*C...				
			Mot.Nr. →804621	09.00-08.03	<b>0 445 020 007</b>	<b>0 986 437 341</b>	
			Mot.Nr. 804622→	09.00-08.03		<b>0 445 020 175</b>	





<b>180 E 21 [03]</b>	5,9	154	F4AE0681D*C...					
			Mot.Nr. →804621		09.03-08.05	<b>0 445 020 007</b>	<b>0 986 437 341</b>	
			Mot.Nr. 804622→		09.03-08.05	<b>0 445 020 175</b>		
24	5,9	176	F4AE0681B*C...					
			Mot.Nr. →804621		09.00-08.03	<b>0 445 020 007</b>	<b>0 986 437 341</b>	
			Mot.Nr. 804622→		09.00-08.03	<b>0 445 020 175</b>		
24 [03]	5,9	176	F4AE0681B*C...					
			Mot.Nr. →804621		09.03-08.05	<b>0 445 020 007</b>	<b>0 986 437 341</b>	
			Mot.Nr. 804622→		09.03-08.05	<b>0 445 020 175</b>		
25 [03]	5,9	185	F4AE3681D*...					
			Mot.Nr. →804621		09.05→	<b>0 445 020 007</b>	<b>0 986 437 341</b>	
			Mot.Nr. 804622→		09.05→	<b>0 445 020 175</b>		
28	5,9	202	F4AE0681A*C...					
			Mot.Nr. →804621		09.00-08.03	<b>0 445 020 007</b>	<b>0 986 437 341</b>	
			Mot.Nr. 804622→		09.00-08.03	<b>0 445 020 175</b>		
28 [03]	5,9	202	F4AE0681A*C...					
			Mot.Nr. →804621		09.03-08.05	<b>0 445 020 007</b>	<b>0 986 437 341</b>	
			Mot.Nr. 804622→		09.03-08.05	<b>0 445 020 175</b>		
		205	F4AE3681E*...					
			Mot.Nr. →804621		09.05→	<b>0 445 020 007</b>	<b>0 986 437 341</b>	
			Mot.Nr. 804622→		09.05→	<b>0 445 020 175</b>		
30 [03]	5,9	220	F4AE3681A*...					
			Mot.Nr. →804621		09.05→	<b>0 445 020 007</b>	<b>0 986 437 341</b>	
			Mot.Nr. 804622→		09.05→	<b>0 445 020 175</b>		
<b>260 E 28 [03]</b>	5,9	202	F4AE0681A*C...					
			Mot.Nr. →804621		09.03-08.05	<b>0 445 020 007</b>	<b>0 986 437 341</b>	
			Mot.Nr. 804622→		09.03-08.05	<b>0 445 020 175</b>		
<b>320 E 28</b>	5,9	202	F4AE0681A*C...					
			Mot.Nr. →804621		09.00-08.03	<b>0 445 020 007</b>	<b>0 986 437 341</b>	
			Mot.Nr. 804622→		09.00-08.03	<b>0 445 020 175</b>		
<b>Iveco</b>								
<b>2.8</b>	2,8	125	Sofim		12.04→	<b>0 445 020 002</b>	<b>0 986 437 501</b>	
<b>Scudato</b>								
<b>60 .13</b>	2,8	92	8140.43S		10.05→	<b>0 445 020 002</b>	<b>0 986 437 501</b>	

**KAMAZ**

<b>11t</b>								
<b>4308 -A3</b>	6,7	155	6IS... <Euro 3>		01.08→	<b>0 445 020 045</b>	<b>0 986 437 342</b>	
-H3	4,5	136	4IS... <Euro 3>		01.08→	<b>0 445 020 045</b>	<b>0 986 437 342</b>	
<b>18t</b>								
<b>5460</b>	11,8	265	740.72-360 <Euro 4>		10.09→	<b>0 445 020 089</b>		
<b>5480</b>	11,8	294	740.73-400 <Euro 4>		03.08→	<b>0 445 020 089</b>		
<b>20t</b>								
<b>53605 -D3</b>	6,7	210	6ISBe285 <Euro 3>		01.08→	<b>0 445 020 045</b>	<b>0 986 437 342</b>	
<b>25t</b>								
<b>62115</b>	11,8	206/236	740.70-280 <Euro 4>; 740.71-320 <Euro 4>		10.09→	<b>0 445 020 089</b>		
<b>65115 -D3</b>	6,7	210	6ISBe285 <Euro 3>		01.08→	<b>0 445 020 045</b>	<b>0 986 437 342</b>	

**KAVZ KURGAN**

<b>Serie 4000</b>								
<b>4235</b>	3,9	110	ISBe 150 31 <Euro 3>		09.08→	<b>0 445 020 045</b>	<b>0 986 437 342</b>	
	4,5	136	4ISBe185B <Euro 3>		09.08→	<b>0 445 020 045</b>	<b>0 986 437 342</b>	
<b>4238</b>	6,7	155	6ISBe 210 <Euro 3>		09.08→	<b>0 445 020 045</b>	<b>0 986 437 342</b>	
<b>Serie 320000</b>								
<b>324410</b>	4,8	115	D 245.30 E3 <Euro 3>		01.08→	<b>0 445 020 088</b>		





**LDV GROUP LIMITED**

<b>Maxus</b>					
2.5	2,5	70-88	VM39C; VM40C	01.05→	<b>0 445 010 034</b>

**LIAZ LIKINSKI (RUS)**

<b>Serie 6000</b>					
6212	11,1	303	650 DCi 11 <Euro 3>	06.08→	<b>0 445 020 086</b>

**MAN**

<b>Bus 18t</b>					
18.320 HOCLN	10,5	235	D2066 LOH01 <Euro 4>	10.06→	<b>0 445 020 075 0 986 437 350</b>
18.360 HOCLN	10,5	265	D2066 LOH02 <Euro 4>	10.06→	<b>0 445 020 075 0 986 437 350</b>
18.400 HOCLN	10,5	294	D2066 LOH03 <Euro 4>	10.06→	<b>0 445 020 075 0 986 437 350</b>
18.440 HOCLN	10,5	324	D2066 LOH04 <Euro 4>	10.06→	<b>0 445 020 075 0 986 437 350</b>

<b>Bus 24t</b>					
24.320 HOCLN	10,5	235	D2066 LOH01 <Euro 4>	10.06→	<b>0 445 020 075 0 986 437 350</b>
24.360 HOCLN	10,5	265	D2066 LOH02 <Euro 4>	10.06→	<b>0 445 020 075 0 986 437 350</b>
24.400 HOCLN	10,5	294	D2066 LOH03 <Euro 4>	10.06→	<b>0 445 020 075 0 986 437 350</b>
24.440 HOCLN	10,5	324	D2066 LOH04 <Euro 4>	10.06→	<b>0 445 020 075 0 986 437 350</b>

<b>Lion's City</b>					
G, GL	10,5	228/257	D 2066 LUH02 <Euro4>; D 2066 LUH12 <Euro4>	10.06→	<b>0 445 020 075 0 986 437 350</b>

<b>Lion's City / NL</b>					
[A21]	6,9	176	D 0836 LUH41 <Euro 3>	06.04-09.06	EXW,MPR <b>0 445 020 060 0 986 437 352</b> MPR <b>0 445 020 014</b>

NL 243 [A37]	6,9	176	D 0836 LOH41 <Euro 3>	01.02-09.06	EXW,MPR <b>0 445 020 060 0 986 437 352</b> MPR <b>0 445 020 014</b>
--------------	-----	-----	-----------------------	-------------	--

NL 283 [A37]	6,9	206	D 0836 LOH40 <Euro 3>	01.02-09.06	EXW,MPR <b>0 445 020 060 0 986 437 352</b> MPR <b>0 445 020 014</b>
--------------	-----	-----	-----------------------	-------------	--

<b>Lion's City M / NM</b>					
[A47]	6,9	176/206	D 0836 LOH51 <Euro 4>; D 0836 LOH52 <Euro 4>	01.06-08.09	EXW <b>0 445 020 060 0 986 437 352</b>

<b>Lion's City Ü</b>					
[A21]	10,5	199/228	D 2066 LUH11 <Euro 4>; D 2066 LUH12 <Euro 4>	10.06→	<b>0 445 020 075 0 986 437 350</b>

<b>Lion's City Ü / NÜ</b>					
[A20]	6,9	176	D 0836 LUH41 <Euro 3>	06.04-09.06	EXW,MPR <b>0 445 020 060 0 986 437 352</b> MPR <b>0 445 020 014</b>
		206	D 0836 LUH40 <Euro 3>	06.04-09.06	EXW,MPR <b>0 445 020 060 0 986 437 352</b> MPR <b>0 445 020 014</b>

<b>Lion's Coach</b>					
	10,5	294/324	D 2066 LOH03 <Euro 4>; D 2066 LOH04 <Euro 4>	09.05→	<b>0 445 020 075 0 986 437 350</b>

<b>C, L</b>					
	10,5	294/324	D 2066 LOH07 <Euro 4/OBD1>; D 2066 LOH08 <Euro 4/OBD1>	04.07→	<b>0 445 020 075 0 986 437 350</b>

	12,4	338	D 2676 LOH01 <V6700, Euro 4>	09.05-09.06	<b>0 445 020 075 0 986 437 350</b>
--	------	-----	------------------------------	-------------	------------------------------------

<b>Lion's Regio C</b>					
[R12, R14]	10,5	228/257/287	D 2066 LUH01 <Euro4>; D 2066 LUH02 <V6400, Euro4>; D 2066 LUH03 <V6400, Euro4>	10.06-05.07	<b>0 445 020 075 0 986 437 350</b>

<b>Lion's Regio L</b>					
[R13]	10,5	228/257/287	D 2066 LUH01 <Euro4>; D 2066 LUH02 <Euro4>; D 2066 LUH03 <Euro4>	10.06-05.07	<b>0 445 020 075 0 986 437 350</b>

<b>TAG</b>					
24.430 FN, FP	10,5	316	D 2066 LF01 <V5500, Euro 3>	09.04-09.06	<b>0 445 020 023 0 986 437 351</b>

<b>TGA</b>					
18.310 FA, FH, FC, FK, FL	10,5	228	D 2066 LF04 <V5500, Euro 3>; D 2066 LF14 <V5500, Euro 4>	03.04-09.07	<b>0 445 020 023 0 986 437 351</b>

18.320 F, FL, FA, FC, FK, FL, FC, FK, FL	10,5	235	D 2066 LF20 <V5500, Euro 5>; D 2066 LF28 <Euro 5/OBD1>; D 2066 LF30 <Euro 5/OBD1>; D 2066 LF35 <V5500, Euro 4>; D 2066 LF39 <V5500, Euro 4>	07.06-03.09	<b>0 445 020 075 0 986 437 350</b>
--	------	-----	---	-------------	------------------------------------





								
<b>18.350</b> FA, FA, FC, FK, FL, FA, FH, FC, FK, FL	10,5	257	D 2066 LF03 <V5500, Euro 3>; D 2066 LF13 <V5500, Euro 4>		03.04-08.08		<b>0 445 020 023</b>	<b>0 986 437 351</b>
<b>18.360</b> F, FL, FA, FC, FK, FL	10,5	265	D 2066 LF19 <V5500, Euro 5>; D 2066 LF27 <Euro 5/OBD1>; D 2066 LF29 <V5500, Euro 5>; D 2066 LF33 <V5500, Euro 4>; D 2066 LF38 <V5500, Euro 4>		07.06-03.09		<b>0 445 020 075</b>	<b>0 986 437 350</b>
<b>18.390</b> FA, FH, FA, FL, FC, FK, FL	10,5	287	D 2066 LF02 <V5500, Euro 3>; D 2066 LF12 <Euro 4>		03.04-08.08		<b>0 445 020 023</b>	<b>0 986 437 351</b>
<b>18.400</b> F, FL, FA, FC, FK, FL, FC, FK, FL	10,5	292/294	D 2066 LF18 <Euro 5/OBD1>; D 2066 LF22 <V5500, Euro 5>; D 2066 LF24 <Euro 5/OBD1>; D 2066 LF26 <Euro 5/OBD1>; D 2066 LF32 <V5500, Euro 4>; D 2066 LF37 <V5500, Euro 4>		01.06-03.09		<b>0 445 020 075</b>	<b>0 986 437 350</b>
<b>18.430</b> FA, FH, FC, FK, FL	10,5	316	D 2066 LF01 <V5500, Euro 3>; D 2066 LF11 <V5500, Euro 4>		03.04-08.08		<b>0 445 020 023</b>	<b>0 986 437 351</b>
<b>18.440</b> F, FL, FA, FC, FH, FK, FL, FA, FC, FK, FL, FC, FK, FL	10,5	321/324	D 2066 LF17 <Euro 5/OBD1>; D 2066 LF21 <V5500, Euro 5>; D 2066 LF23 <Euro 5/OBD1>; D 2066 LF25 <Euro 5/OBD1>; D 2066 LF31 <V5500, Euro 4>; D 2066 LF36 <V5500, Euro 4>		01.06-03.09		<b>0 445 020 075</b>	<b>0 986 437 350</b>
<b>18.480</b> F, FA, FC, FK, FL	12,8	353	D 2876 LF12 <V5300, Euro 3>		10.02-09.06		<b>0 445 020 018</b>	<b>0 986 437 353</b>
F, FL, FA, FC, FH, FK, FL	12,4	353	D 2676 LF01 <V7300, Euro 4>; D 2676 LF05 <V7300, Euro 4>; D 2676 LF12 <V7300, Euro 5 OBD>; D 2676 LF14 <V7300, Euro 5>; D 2676 LF16 <V7300, Euro 5>		04.06-03.09		<b>0 445 020 075</b>	<b>0 986 437 350</b>
<b>18.530</b> F, FL, FC, FK, FL	12,8	390	D 2876 LF13 <V5300, Euro 3>		10.02-09.06		<b>0 445 020 018</b>	<b>0 986 437 353</b>
<b>18.540</b> F, FL	12,4	397	D 2676 LF11 <Euro 5/OBD1>; D 2676 LF13 <V7300, Euro 5>; D 2676 LF15 <V7300, Euro 5>		02.07-08.08		<b>0 445 020 075</b>	<b>0 986 437 350</b>
<b>19.350</b> FL-, FC-, FK-WW	10,5	258	D 2066 LF03 <Euro 3>		07.06-05.10		<b>0 445 020 023</b>	<b>0 986 437 351</b>
<b>19.360</b> FL-, FC-, FK-WW	10,5	265	D 2066 LF07 <Euro 2>		07.06-05.10		<b>0 445 020 023</b>	<b>0 986 437 351</b>
<b>19.390</b> FL-, FC-, FK-WW	10,5	287	D 2066 LF02 <Euro 3>		07.06-05.10		<b>0 445 020 023</b>	<b>0 986 437 351</b>
<b>19.400</b> FL-, FC-, FK-WW	10,5	294	D 2066 LF06 <Euro 2>		07.06-05.10		<b>0 445 020 023</b>	<b>0 986 437 351</b>
<b>19.430</b> FL-, FC-, FK-WW	10,5	316	D 2066 LF01 <Euro 3>		07.06-05.10		<b>0 445 020 023</b>	<b>0 986 437 351</b>
<b>19.440</b> FL-, FC-, FK-WW	12,4	324	D 2676 LF04 <Euro 2>		07.06-05.10		<b>0 445 020 075</b>	<b>0 986 437 350</b>
<b>19.480</b> FL-, FC-, FK-WW	12,4	353	D 2676 LF02 <Euro 3>; D 2676 LF03 <Euro 2>		07.06-05.10		<b>0 445 020 075</b>	<b>0 986 437 350</b>
<b>24.350</b> FN, FP	10,5	257	D 2066 LF03 <V5500, Euro 3>; D 2066 LF13 <V5500, Euro 4>		09.04-09.06		<b>0 445 020 023</b>	<b>0 986 437 351</b>
<b>24.360</b> DF, FN	10,5	265	D 2066 LF19 <V5500, Euro 5>; D 2066 LF27 <Euro 5/OBD1>; D 2066 LF29 <V5500, Euro 5>; D 2066 LF33 <V5500, Euro 4>; D 2066 LF38 <V5500, Euro 4>		07.06-03.09		<b>0 445 020 075</b>	<b>0 986 437 350</b>
<b>24.390</b> FN, FP	10,5	287	D 2066 LF02 <V5500, Euro 3>; D 2066 LF12 <Euro 4>		09.04-09.06		<b>0 445 020 023</b>	<b>0 986 437 351</b>
<b>24.400</b> DF, FN	10,5	292/294	D 2066 LF18 <Euro 5/OBD1>; D 2066 LF22 <V5500, Euro 5>; D 2066 LF24 <Euro 5/OBD1>; D 2066 LF26 <Euro 5/OBD1>; D 2066 LF32 <V5500, Euro 4>; D 2066 LF37 <V5500, Euro 4>		07.06-03.09		<b>0 445 020 075</b>	<b>0 986 437 350</b>
<b>24.430</b> FN, FP	10,5	316	D 2066 LF11 <V5500, Euro 4>		10.04-09.06		<b>0 445 020 023</b>	<b>0 986 437 351</b>
<b>24.440</b> DF, FD, FN, FN, FP	10,5	321/324	D 2066 LF17 <Euro 5/OBD1>; D 2066 LF21 <V5500, Euro 5>; D 2066 LF23 <Euro 5/OBD1>; D 2066 LF25 <Euro 5/OBD1>; D 2066 LF31 <V5500, Euro 4>; D 2066 LF36 <V5500, Euro 4>		07.06-03.09		<b>0 445 020 075</b>	<b>0 986 437 350</b>
<b>24.480</b> DF, FN	12,4	353	D 2676 LF01 <V7300, Euro 4>; D 2676 LF05 <V7300, Euro 4>; D 2676 LF12 <V7300, Euro 5 OBD>; D 2676 LF14 <V7300, Euro 5>; D 2676 LF16 <V7300, Euro 5>		07.06-03.09		<b>0 445 020 075</b>	<b>0 986 437 350</b>
FN, FP, FV	12,8	353	D 2876 LF12 <V5300, Euro 3>		06.03-09.06		<b>0 445 020 018</b>	<b>0 986 437 353</b>
<b>24.530</b> FN, FP, FV	12,8	390	D 2876 LF13 <V5300, Euro 3>		12.02-09.06		<b>0 445 020 018</b>	<b>0 986 437 353</b>
<b>24.540</b> DF	12,4	397	D 2676 LF11 <Euro 5/OBD1>; D 2676 LF13 <V7300, Euro 5>; D 2676 LF15 <V7300, Euro 5>		02.07-08.08		<b>0 445 020 075</b>	<b>0 986 437 350</b>
<b>26.280</b> DF	6,9	206	D 0836 LF41 <V5200, Euro 3>		03.03-02.05		<b>0 445 020 014</b>	
<b>26.310</b> FD, FH, FN, FV, FD, FV	10,5	228	D 2066 LF04 <V5500, Euro 3>; D 2066 LF14 <V5500, Euro 4>		03.04-09.07		<b>0 445 020 023</b>	<b>0 986 437 351</b>





◀ MAN

<b>26.320</b> FD, FH, FN, FV	10,5	235	D 2066 LF20 <V5500, Euro 5>; D 2066 LF28 <Euro 5/OBD1>; D 2066 LF30 <Euro 5/OBD1>; D 2066 LF35 <V5500, Euro 4>; D 2066 LF39 <V5500, Euro 4>	07.06-09.08	<b>0 445 020 075</b>	<b>0 986 437 350</b>
<b>26.330</b> DA	6,9	240	D 0836 LF44 <V5200, Euro 3>	03.03-02.05	<b>0 445 020 014</b>	
<b>26.350</b> FD, FH, FN, FV, FD, FV	10,5	257	D 2066 LF03 <V5500, Euro 3>; D 2066 LF13 <V5500, Euro 4>	03.04-09.06	<b>0 445 020 023</b>	<b>0 986 437 351</b>
<b>26.360</b> FD, FH, FN, FV	10,5	265	D 2066 LF19 <V5500, Euro 5>; D 2066 LF27 <Euro 5/OBD1>; D 2066 LF29 <V5500, Euro 5>; D 2066 LF33 <V5500, Euro 4>; D 2066 LF38 <V5500, Euro 4>	07.06-09.08	<b>0 445 020 075</b>	<b>0 986 437 350</b>
<b>26.390</b> FD, FFD, FD, FFD, FV, FD, FH, FN, FV	10,5	287	D 2066 LF02 <V5500, Euro 3>; D 2066 LF12 <Euro 4>	03.04-09.06	<b>0 445 020 023</b>	<b>0 986 437 351</b>
<b>26.400</b> FD, FH, FN, FV	10,5	292/294	D 2066 LF18 <Euro 5/OBD1>; D 2066 LF22 <V5500, Euro 5>; D 2066 LF24 <Euro 5/OBD1>; D 2066 LF26 <Euro 5/OBD1>; D 2066 LF32 <V5500, Euro 4>; D 2066 LF37 <V5500, Euro 4>	01.06-09.08	<b>0 445 020 075</b>	<b>0 986 437 350</b>
<b>26.430</b> FD, FD, FH, FN, FV	10,5	316	D 2066 LF01 <V5500, Euro 3>; D 2066 LF11 <V5500, Euro 4>	03.04-09.06	<b>0 445 020 023</b>	<b>0 986 437 351</b>
<b>26.440</b> F, FL, FD, FH, FN, FV	10,5	321/324	D 2066 LF17 <Euro 5/OBD1>; D 2066 LF21 <V5500, Euro 5>; D 2066 LF23 <Euro 5/OBD1>; D 2066 LF25 <Euro 5/OBD1>; D 2066 LF31 <V5500, Euro 4>; D 2066 LF36 <V5500, Euro 4>	01.06-03.09	<b>0 445 020 075</b>	<b>0 986 437 350</b>
<b>26.480</b> DA, FD, FN, FP, FV	12,8	353	D 2876 LF12 <V5300, Euro 3>	09.02-09.06	<b>0 445 020 018</b>	<b>0 986 437 353</b>
FD, FH, FN, FV	12,4	353	D 2676 LF01 <V7300, Euro 4>; D 2676 LF05 <V7300, Euro 4>; D 2676 LF12 <V7300, Euro 5>; D 2676 LF14 <V7300, Euro 5>; D 2676 LF16 <V7300, Euro 5>	07.06-03.09	<b>0 445 020 075</b>	<b>0 986 437 350</b>
<b>26.530</b> DA, FD, FN, FP, FV	12,8	390	D 2876 LF13 <V5300, Euro 3>	09.02-09.06	<b>0 445 020 018</b>	<b>0 986 437 353</b>
<b>26.540</b> FD, FH, FN, FV	12,4	397	D 2676 LF11 <Euro 5/OBD1>; D 2676 LF13 <V7300, Euro 5>; D 2676 LF15 <V7300, Euro 5>	02.07-08.08	<b>0 445 020 075</b>	<b>0 986 437 350</b>
<b>28.310</b> DF, FN	10,5	228	D 2066 LF04 <V5500, Euro 3>; D 2066 LF14 <V5500, Euro 4>	03.04-06.07	<b>0 445 020 023</b>	<b>0 986 437 351</b>
<b>28.320</b> DF, FN	10,5	235/236	D 2066 LF20 <V5500, Euro 5>; D 2066 LF28 <Euro 5/OBD1>; D 2066 LF30 <Euro 5/OBD1>; D 2066 LF35 <V5500, Euro 4>; D 2066 LF39 <V5500, Euro 4>	04.06-08.08	<b>0 445 020 075</b>	<b>0 986 437 350</b>
<b>28.350</b> DF, FN	10,5	257	D 2066 LF03 <V5500, Euro 3>; D 2066 LF13 <V5500, Euro 4>	03.04-09.06	<b>0 445 020 023</b>	<b>0 986 437 351</b>
<b>28.360</b> DF, FN	10,5	265	D 2066 LF19 <V5500, Euro 5>; D 2066 LF27 <Euro 5/OBD1>; D 2066 LF29 <V5500, Euro 5>; D 2066 LF33 <V5500, Euro 4>; D 2066 LF38 <V5500, Euro 4>	07.06-08.08	<b>0 445 020 075</b>	<b>0 986 437 350</b>
<b>28.390</b> FN	10,5	287	D 2066 LF02 <V5500, Euro 3>; D 2066 LF12 <Euro 4>	03.04-09.06	<b>0 445 020 023</b>	<b>0 986 437 351</b>
<b>28.400</b> FN	10,5	292/294	D 2066 LF18 <Euro 5/OBD1>; D 2066 LF22 <V5500, Euro 5>; D 2066 LF24 <Euro 5/OBD1>; D 2066 LF26 <Euro 5/OBD1>; D 2066 LF32 <V5500, Euro 4>; D 2066 LF37 <V5500, Euro 4>	07.06-08.08	<b>0 445 020 075</b>	<b>0 986 437 350</b>
<b>28.430</b> FN	10,5	257/316	D 2066 LF01 <V5500, Euro 3>; D 2066 LF11 <V5500, Euro 4>	03.04-09.06	<b>0 445 020 023</b>	<b>0 986 437 351</b>
<b>28.440</b> DF, FN	10,5	321/324	D 2066 LF17 <Euro 5/OBD1>; D 2066 LF21 <V5500, Euro 5>; D 2066 LF23 <Euro 5/OBD1>; D 2066 LF25 <Euro 5/OBD1>; D 2066 LF31 <V5500, Euro 4>; D 2066 LF36 <V5500, Euro 4>	01.06-08.08	<b>0 445 020 075</b>	<b>0 986 437 350</b>
<b>28.480</b> DF	12,8	353	D 2876 LF12 <V5300, Euro 3>	06.03-09.06	<b>0 445 020 018</b>	<b>0 986 437 353</b>
FN	12,4	353	D 2676 LF01 <V7300, Euro 4>; D 2676 LF05 <V7300, Euro 4>; D 2676 LF12 <V7300, Euro 5 OBD>; D 2676 LF14 <V7300, Euro 5>; D 2676 LF16 <V7300, Euro 5>	07.06-08.08	<b>0 445 020 075</b>	<b>0 986 437 350</b>
<b>28.530</b> DF	12,8	390	D 2876 LF13 <V5300, Euro 3>	09.02-09.06	<b>0 445 020 018</b>	<b>0 986 437 353</b>
<b>28.540</b> FN	12,4	397	D 2676 LF11 <Euro 5/OBD1>; D 2676 LF13 <V7300, Euro 5>; D 2676 LF15 <V7300, Euro 5>	02.07-08.08	<b>0 445 020 075</b>	<b>0 986 437 350</b>



									
<b>32.350</b> FFD	10,5	257	D 2066 LF03 <V5500, Euro 3>; D 2066 LF13 <V5500, Euro 4>	06.04-09.06	<b>0 445 020 023</b>	<b>0 986 437 351</b>			
<b>32.360</b> FFD	10,5	265	D 2066 LF33 <V5500, Euro 4>; D 2066 LF38 <V5500, Euro 4>	07.06-08.08	<b>0 445 020 075</b>	<b>0 986 437 350</b>			
<b>32.390</b> FFD	10,5	287	D 2066 LF02 <V5500, Euro 3>	06.04-09.06	<b>0 445 020 023</b>	<b>0 986 437 351</b>			
<b>32.400</b> FFD	10,5	292/294	D 2066 LF32 <V5500, Euro 4>; D 2066 LF37 <V5500, Euro 4>	07.06-08.08	<b>0 445 020 075</b>	<b>0 986 437 350</b>			
<b>32.430</b> FFD	10,5	316	D 2066 LF01 <V5500, Euro 3>; D 2066 LF11 <V5500, Euro 4>	06.04-09.06	<b>0 445 020 023</b>	<b>0 986 437 351</b>			
<b>32.440</b> FFD	10,5	324	D 2066 LF31 <V5500, Euro 4>; D 2066 LF36 <V5500, Euro 4>	07.06-08.08	<b>0 445 020 075</b>	<b>0 986 437 350</b>			
<b>32.480</b> FFD	12,4	353	D 2676 LF01 <V7300, Euro 4>; D 2676 LF05 <V7300, Euro 4>	07.06-08.08	<b>0 445 020 075</b>	<b>0 986 437 350</b>			
	12,8	352	D 2876 LF12 <V5300, Euro 3>	05.04-01.06	<b>0 445 020 018</b>	<b>0 986 437 353</b>			
<b>32.530</b> DA	12,8	390	D 2876 LF13 <V5300, Euro 3>	05.04-09.04	<b>0 445 020 018</b>	<b>0 986 437 353</b>			
<b>33.310</b> FFD	10,5	228	D 2066 LF04 <V5500, Euro 3>	03.04-09.06	<b>0 445 020 023</b>	<b>0 986 437 351</b>			
<b>33.350</b> DF, FD, FDA, FDA, FD-WW	10,5	257	D 2066 LF03 <Euro 3>; D 2066 LF03 <V5500, Euro 3>; D 2066 LF13 <V5500, Euro 4>	03.04-05.10	<b>0 445 020 023</b>	<b>0 986 437 351</b>			
<b>33.360</b> FD	10,5	265	D 2066 LF33 <V5500, Euro 4>	07.06-09.08	<b>0 445 020 075</b>	<b>0 986 437 350</b>			
			D 2066 LF38 <V5500, Euro 4>	10.07-09.08	<b>0 445 020 075</b>	<b>0 986 437 350</b>			
FD-, FDA-WW	10,5	265	D 2066 LF07 <Euro 2>	07.06-05.10	<b>0 445 020 023</b>	<b>0 986 437 351</b>			
<b>33.390</b> DF, FDA, FD-WW	10,5	287	D 2066 LF02 <Euro 3>; D 2066 LF02 <V5500, Euro 3>; D 2066 LF12 <Euro 4>	03.04-05.10	<b>0 445 020 023</b>	<b>0 986 437 351</b>			
<b>33.400</b> FD	10,5	292	D 2066 LF32 <V5500, Euro 4>	07.06-08.08	<b>0 445 020 075</b>	<b>0 986 437 350</b>			
		294	D 2066 LF37 <V5500, Euro 4>	10.07-08.08	<b>0 445 020 075</b>	<b>0 986 437 350</b>			
FD-, FDA-WW	10,5	294	D 2066 LF06 <Euro 2>	07.06-05.10	<b>0 445 020 023</b>	<b>0 986 437 351</b>			
<b>33.430</b> DF, FDA, FD-WW	10,5	316	D 2066 LF01 <Euro 3>; D 2066 LF01 <V5500, Euro 3>; D 2066 LF11 <V5500, Euro 4>	03.04-05.10	<b>0 445 020 023</b>	<b>0 986 437 351</b>			
<b>33.440</b> FD	10,5	324	D 2066 LF31 <V5500, Euro 4>; D 2066 LF36 <V5500, Euro 4>	07.06-08.08	<b>0 445 020 075</b>	<b>0 986 437 350</b>			
FD-, FDA-WW	12,4	324	D 2676 LF04 <Euro 2>	07.06-05.10	<b>0 445 020 075</b>	<b>0 986 437 350</b>			
<b>33.480</b> DA, FDA-WW, FD-WW	12,8	352/353	D 2876 LF12 <Euro 3>; D 2876 LF12 <V5300, Euro 3>	10.02-03.09	<b>0 445 020 018</b>	<b>0 986 437 353</b>			
FD	12,4	353	D 2676 LF01 <V7300, Euro 4>	07.06-08.08	<b>0 445 020 075</b>	<b>0 986 437 350</b>			
FD, FD-, FDA-WW, FD-WW	12,4	353	D 2676 LF02 <Euro 3>; D 2676 LF03 <Euro 2>; D 2676 LF05 <V7300, Euro 4>	07.06-05.10	<b>0 445 020 075</b>	<b>0 986 437 350</b>			
FD-WW	12,4	353	D 2876 LF25 <Euro 2>	07.06-03.09	<b>0 445 020 018</b>	<b>0 986 437 353</b>			
<b>33.530</b> DF	12,8	390	D 2876 LF13 <V5300, Euro 3>	10.02-09.06	<b>0 445 020 018</b>	<b>0 986 437 353</b>			
<b>35.350</b> FFD, FV, VF	10,5	257	D 2066 LF03 <V5500, Euro 3>; D 2066 LF13 <V5500, Euro 4>	03.04-09.06	<b>0 445 020 023</b>	<b>0 986 437 351</b>			
<b>35.360</b> FFD	10,5	265	D 2066 LF33 <V5500, Euro 4>; D 2066 LF38 <V5500, Euro 4>	07.06-08.08	<b>0 445 020 075</b>	<b>0 986 437 350</b>			
<b>35.390</b> FFD, FV	10,5	287	D 2066 LF02 <V5500, Euro 3>; D 2066 LF12 <Euro 4>	03.04-09.06	<b>0 445 020 023</b>	<b>0 986 437 351</b>			
<b>35.400</b> FFD	10,5	292/294	D 2066 LF32 <V5500, Euro 4>; D 2066 LF37 <V5500, Euro 4>	07.06-08.08	<b>0 445 020 075</b>	<b>0 986 437 350</b>			
<b>35.430</b> FFD, FV	10,5	316	D 2066 LF01 <V5500, Euro 3>; D 2066 LF11 <V5500, Euro 4>	03.04-09.06	<b>0 445 020 023</b>	<b>0 986 437 351</b>			
<b>35.440</b> FFD	10,5	324	D 2066 LF31 <V5500, Euro 4>; D 2066 LF36 <V5500, Euro 4>	07.06-08.08	<b>0 445 020 075</b>	<b>0 986 437 350</b>			
<b>35.480</b> FFD	12,4	353	D 2676 LF01 <V7300, Euro 4>; D 2676 LF05 <V7300, Euro 4>	07.06-08.08	<b>0 445 020 075</b>	<b>0 986 437 350</b>			
	12,8	352/353	D 2876 LF12 <V5300, Euro 3>	06.03-09.06	<b>0 445 020 018</b>	<b>0 986 437 353</b>			
<b>35.530</b> FFD	12,8	390	D 2876 LF13 <V5300, Euro 3>	06.04-03.06	<b>0 445 020 018</b>	<b>0 986 437 353</b>			
<b>37.350</b> FFD	10,5	257	D 2066 LF03 <V5500, Euro 3>; D 2066 LF13 <V5500, Euro 4>	03.04-09.06	<b>0 445 020 023</b>	<b>0 986 437 351</b>			
<b>37.360</b> FFD	10,5	265	D 2066 LF33 <V5500, Euro 4>; D 2066 LF38 <V5500, Euro 4>	07.06-08.08	<b>0 445 020 075</b>	<b>0 986 437 350</b>			
<b>37.390</b> FFD	10,5	287	D 2066 LF02 <V5500, Euro 3>; D 2066 LF12 <Euro 4>	03.04-09.06	<b>0 445 020 023</b>	<b>0 986 437 351</b>			
<b>37.400</b> FFD	10,5	292/294	D 2066 LF32 <V5500, Euro 4>; D 2066 LF37 <V5500, Euro 4>	07.06-08.08	<b>0 445 020 075</b>	<b>0 986 437 350</b>			













◀ MAN

<b>37.430</b> FFD	10,5	316	D 2066 LF01 <V5500, Euro 3>; D 2066 LF11 <V5500, Euro 4>	03.04-09.06		<b>0 445 020 023</b>	<b>0 986 437 351</b>
<b>37.440</b> FFD	10,5	324	D 2066 LF31 <V5500, Euro 4>; D 2066 LF36 <V5500, Euro 4>	07.06-08.08		<b>0 445 020 075</b>	<b>0 986 437 350</b>
<b>37.480</b> FFD	12,4	353	D 2676 LF01 <V7300, Euro 4>; D 2676 LF05 <V7300, Euro 4>	07.06-08.08		<b>0 445 020 075</b>	<b>0 986 437 350</b>
VF	12,8	353	D 2876 LF12 <V5300, Euro 3>	08.04-09.06		<b>0 445 020 018</b>	<b>0 986 437 353</b>
<b>37.530</b> VF	12,8	390	D 2876 LF13 <V5300, Euro 3>	06.03-09.06		<b>0 445 020 018</b>	<b>0 986 437 353</b>
<b>39.390</b> FV	10,5	287	D 2066 LF02 <V5500, Euro 3>; D 2066 LF12 <Euro 4>	03.04-09.06		<b>0 445 020 023</b>	<b>0 986 437 351</b>
<b>39.400</b> FFD	10,5	292/294	D 2066 LF32 <V5500, Euro 4>; D 2066 LF37 <V5500, Euro 4>	07.06-08.08		<b>0 445 020 075</b>	<b>0 986 437 350</b>
<b>39.430</b> FFD	10,5	316	D 2066 LF01 <V5500, Euro 3>; D 2066 LF11 <V5500, Euro 4>	07.04-09.06		<b>0 445 020 023</b>	<b>0 986 437 351</b>
<b>39.440</b> FFD	10,5	324	D 2066 LF31 <V5500, Euro 4>; D 2066 LF36 <V5500, Euro 4>	07.06-08.08		<b>0 445 020 075</b>	<b>0 986 437 350</b>
<b>39.480</b> FFD	12,4	353	D 2676 LF01 <V7300, Euro 4>; D 2676 LF05 <V7300, Euro 4>	07.06-08.08		<b>0 445 020 075</b>	<b>0 986 437 350</b>
<b>40.390</b> FDA-WW, FD-WW	10,5	287	D 2066 LF02 <Euro 3>	01.05-05.10		<b>0 445 020 023</b>	<b>0 986 437 351</b>
<b>40.400</b> FD-WW	10,5	294	D 2066 LF06 <Euro 2>	07.06-05.10		<b>0 445 020 023</b>	<b>0 986 437 351</b>
			D 2066 LF32 <Euro 4/OBD1>; D 2066 LF37 <Euro 4/OBD1>	09.08-05.10		<b>0 445 020 075</b>	<b>0 986 437 350</b>
<b>40.430</b> FDA-WW, FD-WW	10,5	316	D 2066 LF01 <Euro 3>	07.04-05.10		<b>0 445 020 023</b>	<b>0 986 437 351</b>
<b>40.440</b> FD-WW	10,5	324	D 2066 LF31 <Euro 4/OBD1>; D 2066 LF36 <Euro 4/OBD1>	09.08-05.10		<b>0 445 020 075</b>	<b>0 986 437 350</b>
	12,4	324	D 2676 LF04 <Euro 2>	07.06-05.10		<b>0 445 020 075</b>	<b>0 986 437 350</b>
<b>40.480</b> DF, FD-WW	12,8	353	D 2876 LF12 <Euro 3>; D 2876 LF12 <V5300, Euro 3>; D 2876 LF25 <Euro 2>	10.04-03.09		<b>0 445 020 018</b>	<b>0 986 437 353</b>
FDA-WW	12,4	353	D 2676 LF02 <Euro 3>; D 2676 LF03 <Euro 2>	07.06-05.10		<b>0 445 020 075</b>	<b>0 986 437 350</b>
<b>41.350</b> FFD, FFD-WW	10,5	257	D 2066 LF03 <Euro 3>; D 2066 LF13 <V5500, Euro 4>	03.04-05.10		<b>0 445 020 023</b>	<b>0 986 437 351</b>
<b>41.360</b> FFD	10,5	265	D 2066 LF33 <V5500, Euro 4>	07.06-08.08		<b>0 445 020 075</b>	<b>0 986 437 350</b>
			D 2066 LF38 <V5500, Euro 4>	09.07-08.08		<b>0 445 020 075</b>	<b>0 986 437 350</b>
FV-WW	10,5	265	D 2066 LF07 <Euro 2>	07.06-05.10		<b>0 445 020 023</b>	<b>0 986 437 351</b>
<b>41.390</b> FFD, FFD-WW	10,5	287	D 2066 LF02 <Euro 3>; D 2066 LF12 <Euro 4>	03.04-05.10		<b>0 445 020 023</b>	<b>0 986 437 351</b>
<b>41.400</b> FFD	10,5	292	D 2066 LF32 <V5500, Euro 4>	07.06-08.08		<b>0 445 020 075</b>	<b>0 986 437 350</b>
		294	D 2066 LF37 <V5500, Euro 4>	09.07-08.08		<b>0 445 020 075</b>	<b>0 986 437 350</b>
FV-WW	10,5	294	D 2066 LF06 <Euro 2>	07.06-05.10		<b>0 445 020 023</b>	<b>0 986 437 351</b>
<b>41.430</b> FFD, FFD-WW	10,5	316	D 2066 LF01 <Euro 3>; D 2066 LF01 <V5500, Euro 3>; D 2066 LF11 <V5500, Euro 4>	03.04-05.10		<b>0 445 020 023</b>	<b>0 986 437 351</b>
<b>41.440</b> FFD	10,5	324	D 2066 LF31 <V5500, Euro 4>; D 2066 LF36 <V5500, Euro 4>	07.06-08.08		<b>0 445 020 075</b>	<b>0 986 437 350</b>
FV-WW	12,4	324	D 2676 LF04 <Euro 2>	07.06-05.10		<b>0 445 020 075</b>	<b>0 986 437 350</b>
<b>41.480</b> FFD	12,4	353	D 2676 LF01 <V7300, Euro 4>	07.06-08.08		<b>0 445 020 075</b>	<b>0 986 437 350</b>
FFD, FFD-WW	12,8	353	D 2876 LF12 <Euro 3>; D 2876 LF12 <V5300, Euro 3>	05.03-03.09		<b>0 445 020 018</b>	<b>0 986 437 353</b>
FFD, FV-WW	12,4	353	D 2676 LF02 <Euro 3>; D 2676 LF03 <Euro 2>; D 2676 LF05 <V7300, Euro 4>	07.06-05.10		<b>0 445 020 075</b>	<b>0 986 437 350</b>
FFD-WW	12,4	353	D 2876 LF25 <Euro 2>	07.06-03.09		<b>0 445 020 018</b>	<b>0 986 437 353</b>
<b>41.530</b> FFD, FV	12,8	390	D 2876 LF13 <V5300, Euro 3>	06.03-09.06		<b>0 445 020 018</b>	<b>0 986 437 353</b>
<b>41.540</b> FV	12,4	397	D 2676 LF11 <Euro 5/OBD1>; D 2676 LF13 <V7300, Euro 5>	04.07-07.08		<b>0 445 020 075</b>	<b>0 986 437 350</b>
<b>41.660</b> VF	18,3	485	D 2840 LF25 <V5800, Euro 3>	04.03-09.06		<b>F 00B C00 008</b>	<b>0 986 437 911</b>
<b>TGL</b>							
<b>7.150</b>	4,6	110	D 0834 LFL40 <Euro 3>	06.11→	EXW	<b>0 445 020 060</b>	<b>0 986 437 352</b>
			D 0834 LFL60 <Euro 5/EEV/OBD2>; D 0834 LFL63 <Euro 5/OBD2>	04.09→		<b>0 445 020 100</b>	
L	4,6	110	D 0834 LFL40 <Euro 3>	05.05-09.06	EXW	<b>0 445 020 060</b>	<b>0 986 437 352</b>
			D 0834 LFL50 <Euro 4/OBD1>; D 0834 LFL53 <Euro 4/OBD1>	04.06→	EXW	<b>0 445 020 060</b>	<b>0 986 437 352</b>
<b>7.180</b>	4,6	132	D 0834 LFL41 <Euro 3>	06.11→	EXW	<b>0 445 020 060</b>	<b>0 986 437 352</b>
			D 0834 LFL61 <Euro 5/EEV/OBD2>; D 0834 LFL64 <Euro 5/OBD2>	04.09→		<b>0 445 020 100</b>	



									
		l/ccm	kW/(PS)	Typ					
<b>7.180 L</b>		4,6	132	D 0834 LFL41 <Euro 3>	05.05-09.06	EXW	<b>0 445 020 060</b>	<b>0 986 437 352</b>	
				D 0834 LFL51 <Euro 4/OBD1>; D 0834 LFL54 <Euro 4/OBD1>	04.06→	EXW	<b>0 445 020 060</b>	<b>0 986 437 352</b>	
<b>8.150</b>		4,6	110	D 0834 LFL40 <Euro 3>	06.11→	EXW	<b>0 445 020 060</b>	<b>0 986 437 352</b>	
				D 0834 LFL60 <Euro 5/EEV/OBD2>; D 0834 LFL63 <Euro 5/OBD2>	04.09→		<b>0 445 020 100</b>		
<b>L</b>		4,6	110	D 0834 LFL50 <Euro 4/OBD1>; D 0834 LFL53 <Euro 4/OBD1>	02.07→	EXW	<b>0 445 020 060</b>	<b>0 986 437 352</b>	
<b>8.180</b>		4,6	132	D 0834 LFL61 <Euro 5/EEV/OBD2>; D 0834 LFL64 <Euro 5/OBD2>	04.09→		<b>0 445 020 100</b>		
				D 0834 LFL41 <Euro 3>; D 0834 LFL51 <Euro 4/OBD1>; D 0834 LFL54 <Euro 4/OBD1>	05.05→	EXW	<b>0 445 020 060</b>	<b>0 986 437 352</b>	
<b>8.210 L</b>		4,6	151	D 0834 LFL42 <Euro 3>; D 0834 LFL52 <Euro 4/OBD1>; D 0834 LFL55 <Euro 4/OBD1>	05.05→	EXW	<b>0 445 020 060</b>	<b>0 986 437 352</b>	
<b>8.220</b>		4,6	162	D 0834 LFL62 <Euro 5/EEV/OBD2>; D 0834 LFL65 <Euro 5/OBD2>	04.09→		<b>0 445 020 100</b>		
<b>8.240 L</b>		6,9	176	D 0836 LFL40 <Euro 3>	05.05→	EXW	<b>0 445 020 060</b>	<b>0 986 437 352</b>	
				D 0836 LFL50 <Euro 4/OBD1>	04.06-03.09	TW	<b>0 445 020 073</b>		
					04.06→	EXW,TW	<b>0 445 020 060</b>	<b>0 986 437 352</b>	
					03.10→	TW	<b>0 445 020 073</b>		
			177	D 0836 LFL53 <Euro 4/OBD1>	09.07→	EXW	<b>0 445 020 060</b>	<b>0 986 437 352</b>	
<b>8.250</b>		6,9	184	D 0836 LFL60 <Euro 5/EEV/OBD2>	04.09→		<b>0 445 020 100</b>		
				D 0836 LFL63 <Euro 5/OBD2>	04.09→	TW	<b>0 445 020 100</b>		
					04.10→	TW	<b>0 445 020 167</b>		
<b>10.180</b>		4,6	132	D 0834 LFL61 <Euro 5/EEV/OBD2>; D 0834 LFL64 <Euro 5/OBD2>	04.09→		<b>0 445 020 100</b>		
<b>L</b>		4,6	132	D 0834 LFL41 <Euro 3>; D 0834 LFL51 <Euro 4>; D 0834 LFL54 <Euro 4/OBD1>	05.05→	EXW	<b>0 445 020 060</b>	<b>0 986 437 352</b>	
<b>10.210 L</b>		4,6	151	D 0834 LFL42 <Euro 3>; D 0834 LFL52 <Euro 4>; D 0834 LFL55 <Euro 4/OBD1>	05.05→	EXW	<b>0 445 020 060</b>	<b>0 986 437 352</b>	
<b>10.220</b>		4,6	162	D 0834 LFL62 <Euro 5/EEV/OBD2>; D 0834 LFL65 <Euro 5/OBD2>	04.09→		<b>0 445 020 100</b>		
<b>10.240 L</b>		6,9	176	D 0836 LFL40 <Euro 3>	05.05→	EXW	<b>0 445 020 060</b>	<b>0 986 437 352</b>	
				D 0836 LFL50 <Euro 4/OBD1>	04.06-03.09	TW	<b>0 445 020 073</b>		
					04.06→	EXW,TW	<b>0 445 020 060</b>	<b>0 986 437 352</b>	
					03.10→	TW	<b>0 445 020 073</b>		
			177	D 0836 LFL53 <Euro 4/OBD1>	09.07→	EXW	<b>0 445 020 060</b>	<b>0 986 437 352</b>	
<b>10.250</b>		6,9	184	D 0836 LFL60 <Euro 5/EEV/OBD2>	04.09→		<b>0 445 020 100</b>		
				D 0836 LFL63 <Euro 5/OBD2>	04.09→	TW	<b>0 445 020 100</b>		
					04.10→	TW	<b>0 445 020 167</b>		
<b>12.180</b>		4,6	132	D 0834 LFL61 <Euro 5/EEV/OBD2>; D 0834 LFL64 <Euro 5/OBD2>	04.09→		<b>0 445 020 100</b>		
<b>L</b>		4,6	132	D 0834 LFL41 <Euro 3>; D 0834 LFL51 <Euro 4>; D 0834 LFL54 <Euro 4/OBD1>	05.05→	EXW	<b>0 445 020 060</b>	<b>0 986 437 352</b>	
<b>12.210 L</b>		4,6	151	D 0834 LFL42 <Euro 3>; D 0834 LFL52 <Euro 4>; D 0834 LFL55 <Euro 4/OBD1>	05.05→	EXW	<b>0 445 020 060</b>	<b>0 986 437 352</b>	
<b>12.220</b>		4,6	162	D 0834 LFL62 <Euro 5/EEV/OBD2>; D 0834 LFL65 <Euro 5/OBD2>	04.09→		<b>0 445 020 100</b>		
<b>12.240 L</b>		6,9	176	D 0836 LFL40 <Euro 3>	05.05→	EXW	<b>0 445 020 060</b>	<b>0 986 437 352</b>	
				D 0836 LFL50 <Euro 4/OBD1>	04.06-03.09	TW	<b>0 445 020 073</b>		
					04.06→	EXW,TW	<b>0 445 020 060</b>	<b>0 986 437 352</b>	
					03.10→	TW	<b>0 445 020 073</b>		
			177	D 0836 LFL53 <Euro 4/OBD1>	09.07→	EXW	<b>0 445 020 060</b>	<b>0 986 437 352</b>	
<b>12.250</b>		6,9	184	D 0836 LFL60 <Euro 5/EEV/OBD2>	04.09→		<b>0 445 020 100</b>		
				D 0836 LFL63 <Euro 5/OBD2>	04.09→	TW	<b>0 445 020 100</b>		
					04.10→	TW	<b>0 445 020 167</b>		
<b>TGM</b>									
<b>12.240 L</b>		6,9	177	D 0836 LFL50 <Euro 4/OBD1>	04.06-03.09	TW	<b>0 445 020 073</b>		
					04.06→	EXW,TW	<b>0 445 020 060</b>	<b>0 986 437 352</b>	
					03.10→	TW	<b>0 445 020 073</b>		
			177	D 0836 LFL53 <Euro 4/OBD1>	09.07→	EXW	<b>0 445 020 060</b>	<b>0 986 437 352</b>	
<b>12.250</b>		6,9	184	D 0836 LFL60 <Euro 5/EEV/OBD2>	04.09→		<b>0 445 020 100</b>		













◀ MAN

<b>12.250</b>	6,9	184	D 0836 LFL63 <Euro 5/OBD2>	04.09→	TW	<b>0 445 020 100</b>	
				04.10→	TW	<b>0 445 020 167</b>	
<b>12.280 L</b>	6,9	206	D 0836 LFL51 <V7100, Euro 4>; D 0836 LFL54 <Euro 4/OBD1>	04.06→	EXW	<b>0 445 020 060</b>	<b>0 986 437 352</b>
<b>12.290</b>	6,9	213	D 0836 LFL61 <Euro 5/EEV/OBD2>	04.09→		<b>0 445 020 100</b>	
			D 0836 LFL64 <Euro 5/OBD2>	04.09→	TW	<b>0 445 020 100</b>	
				04.10→	TW	<b>0 445 020 167</b>	
<b>13.240 L</b>	6,9	176	D 0836 LFL40 <Euro 3>	10.06→	EXW	<b>0 445 020 060</b>	<b>0 986 437 352</b>
			D 0836 LFL50 <Euro 4/OBD1>	10.06-03.09	TW	<b>0 445 020 073</b>	
				10.06→	EXW,TW	<b>0 445 020 060</b>	<b>0 986 437 352</b>
				03.10→	TW	<b>0 445 020 073</b>	
		177	D 0836 LFL53 <Euro 4/OBD1>	09.07→	EXW	<b>0 445 020 060</b>	<b>0 986 437 352</b>
<b>13.250</b>	6,9	184	D 0836 LFL60 <Euro 5/EEV/OBD2>	04.09→		<b>0 445 020 100</b>	
			D 0836 LFL63 <Euro 5/OBD2>	04.09→	TW	<b>0 445 020 100</b>	
				04.10→	TW	<b>0 445 020 167</b>	
<b>13.280 L</b>	6,9	206	D 0836 LFL41 <Euro 3>	07.06→	EXW	<b>0 445 020 060</b>	<b>0 986 437 352</b>
			D 0836 LFL51 <V7100, Euro 4>; D 0836 LFL54 <Euro 4/OBD1>	10.06→	EXW	<b>0 445 020 060</b>	<b>0 986 437 352</b>
<b>13.290</b>	6,9	213	D 0836 LFL61 <Euro 5/EEV/OBD2>	04.09→		<b>0 445 020 100</b>	
			D 0836 LFL64 <Euro 5/OBD2>	04.09→	TW	<b>0 445 020 100</b>	
				04.10→	TW	<b>0 445 020 167</b>	
<b>15.240</b>	6,9	176	D 0836 LFL40 <Euro 3>	09.11→	EXW	<b>0 445 020 060</b>	<b>0 986 437 352</b>
L	6,9	177	D 0836 LFL50 <Euro 4/OBD1>	04.06-03.09	TW	<b>0 445 020 073</b>	
				04.06→	EXW,TW	<b>0 445 020 060</b>	<b>0 986 437 352</b>
				03.10→	TW	<b>0 445 020 073</b>	
			D 0836 LFL53 <Euro 4/OBD1>	09.07→	EXW	<b>0 445 020 060</b>	<b>0 986 437 352</b>
<b>15.250</b>	6,9	184	D 0836 LFL60 <Euro 5/EEV/OBD2>	04.09→		<b>0 445 020 100</b>	
			D 0836 LFL63 <Euro 5/OBD2>	04.09→	TW	<b>0 445 020 100</b>	
				04.10→	TW	<b>0 445 020 167</b>	
<b>15.280 , L</b>	6,9	206	D 0836 LFL41 <Euro 3>; D 0836 LFL51 <V7100, Euro 4>; D 0836 LFL54 <Euro 4/OBD1>	04.06→	EXW	<b>0 445 020 060</b>	<b>0 986 437 352</b>
<b>15.290</b>	6,9	213	D 0836 LFL61 <Euro 5/EEV/OBD2>	04.09→		<b>0 445 020 100</b>	
			D 0836 LFL64 <Euro 5/OBD2>	04.09→	TW	<b>0 445 020 100</b>	
				04.10→	TW	<b>0 445 020 167</b>	
<b>15.330 , L</b>	6,9	240	D 0836 LFL44 <Euro 3>; D 0836 LFL55 <Euro 4/OBD1>	09.07→	EXW	<b>0 445 020 060</b>	<b>0 986 437 352</b>
L	6,9	240	D 0836 LFL51 <Euro 4/OBD1>	04.06-09.07	EXW,TW	<b>0 445 020 060</b>	<b>0 986 437 352</b>
					TW	<b>0 445 020 073</b>	
<b>15.340</b>	6,9	250	D 0836 LFL62 <Euro 5/EEV/OBD2>; D 0836 LFL65 <Euro 5/OBD2>	04.09→		<b>0 445 020 100</b>	
<b>18.240 L</b>	6,9	176	D 0836 LFL40 <Euro 3>	10.05→	EXW	<b>0 445 020 060</b>	<b>0 986 437 352</b>
		177	D 0836 LFL50 <Euro 4/OBD1>	04.06-03.09	TW	<b>0 445 020 073</b>	
				04.06→	EXW,TW	<b>0 445 020 060</b>	<b>0 986 437 352</b>
				03.10→	TW	<b>0 445 020 073</b>	
			D 0836 LFL53 <Euro 4/OBD1>	09.07→	EXW	<b>0 445 020 060</b>	<b>0 986 437 352</b>
<b>18.250</b>	6,9	184	D 0836 LFL60 <Euro 5/EEV/OBD2>	04.09→		<b>0 445 020 100</b>	
			D 0836 LFL63 <Euro 5/OBD2>	04.09→	TW	<b>0 445 020 100</b>	
				04.10→	TW	<b>0 445 020 167</b>	
<b>18.280</b>	6,9	206	D 0836 LFL54 <Euro 4/OBD1>	09.07→	EXW	<b>0 445 020 060</b>	<b>0 986 437 352</b>
L	6,9	206	D 0836 LFL41 <Euro 3>	10.05→	EXW	<b>0 445 020 060</b>	<b>0 986 437 352</b>
			D 0836 LFL51 <Euro 4/OBD1>	04.06-03.09	TW	<b>0 445 020 073</b>	
				04.06→	EXW,TW	<b>0 445 020 060</b>	<b>0 986 437 352</b>
				03.10→	TW	<b>0 445 020 073</b>	
<b>18.290</b>	6,9	213	D 0836 LFL61 <Euro 5/EEV/OBD2>	04.09→		<b>0 445 020 100</b>	
			D 0836 LFL64 <Euro 5/OBD2>	04.09→	TW	<b>0 445 020 100</b>	
				04.10→	TW	<b>0 445 020 167</b>	
<b>18.330</b>	6,9	240	D 0836 LFL55 <Euro 4/OBD1>	09.07→	EXW	<b>0 445 020 060</b>	<b>0 986 437 352</b>
L	6,9	240	D 0836 LFL44 <Euro 3>	10.05→	EXW	<b>0 445 020 060</b>	<b>0 986 437 352</b>
			D 0836 LFL52 <Euro 4/OBD1>	07.06→	EXW,TW	<b>0 445 020 060</b>	<b>0 986 437 352</b>
					TW	<b>0 445 020 073</b>	
<b>18.340</b>	6,9	250	D 0836 LFL62 <Euro 5/EEV/OBD2>; D 0836 LFL65 <Euro 5/OBD2>	04.09→		<b>0 445 020 100</b>	
<b>22.240 L</b>	6,9	176	D 0836 LFL53 <Euro 4/OBD1>	09.07→	EXW	<b>0 445 020 060</b>	<b>0 986 437 352</b>



										
22.250	6,9	184	D 0836 LFL60 <Euro 5/EEV/OBD2>	04.09→					<b>0 445 020 100</b>	
			D 0836 LFL63 <Euro 5/OBD2>	04.09→	TW			<b>0 445 020 100</b>		
				04.10→	TW				<b>0 445 020 167</b>	
22.280	6,9	206	D 0836 LFL54 <Euro 4/OBD1>	09.07→	EXW				<b>0 445 020 060</b>	<b>0 986 437 352</b>
22.290	6,9	213	D 0836 LFL61 <Euro 5/EEV/OBD2>	04.09→					<b>0 445 020 100</b>	
			D 0836 LFL64 <Euro 5/OBD2>	04.09→	TW			<b>0 445 020 100</b>		
				04.10→	TW				<b>0 445 020 167</b>	
26.280 L	6,9	206	D 0836 LFL51 <Euro 4/OBD1>	09.06-03.09	TW				<b>0 445 020 073</b>	
				09.06→	EXW,TW			<b>0 445 020 060</b>	<b>0 986 437 352</b>	
				03.10→	TW			<b>0 445 020 073</b>		
			D 0836 LFL54 <Euro 4/OBD1>	09.07→	EXW				<b>0 445 020 060</b>	<b>0 986 437 352</b>
26.290	6,9	213	D 0836 LFL61 <Euro 5/EEV/OBD2>	04.09→					<b>0 445 020 100</b>	
			D 0836 LFL64 <Euro 5/OBD2>	04.09→	TW			<b>0 445 020 100</b>		
				04.10→	TW				<b>0 445 020 167</b>	
26.330 L	6,9	240	D 0836 LFL52 <Euro 4/OBD1>	07.06→	EXW,TW				<b>0 445 020 060</b>	<b>0 986 437 352</b>
					TW			<b>0 445 020 073</b>		
			D 0836 LFL55 <Euro 4/OBD1>	09.07→	EXW				<b>0 445 020 060</b>	<b>0 986 437 352</b>
26.340	6,9	250	D 0836 LFL62 <Euro 5/EEV/OBD2>; D 0836 LFL65 <Euro 5/OBD2>	04.09→					<b>0 445 020 100</b>	
<b>TGS</b>										
18.320	10,5	235	D 2066 LF20 <Euro 5/OBD1>; D 2066 LF28 <Euro 5/OBD1>; D 2066 LF39 <Euro 4/OBD1>; D 2066 LF43 <Euro 5/OBD2>; D 2066 LF60 <Euro 5/EEV/OBD2>	10.07→					<b>0 445 020 075</b>	<b>0 986 437 350</b>
			D 2066 LF53 <Euro 5/OBD2>	10.09→				<b>0 445 020 090</b>		
18.360	10,5	265	D 2066 LF19 <Euro 5/OBD1>; D 2066 LF27 <Euro 5/OBD1>; D 2066 LF38 <Euro 4/OBD1>; D 2066 LF42 <Euro 5/OBD2>; D 2066 LF59 <Euro 5/EEV/OBD2>	10.07→					<b>0 445 020 075</b>	<b>0 986 437 350</b>
			D 2066 LF52 <Euro 5/OBD2>	10.09→				<b>0 445 020 090</b>		
18.400	10,5	294	D 2066 LF18 <Euro 5/OBD1>; D 2066 LF26 <Euro 5/OBD1>; D 2066 LF37 <Euro 4/OBD1>; D 2066 LF41 <Euro 5/OBD2>; D 2066 LF58 <Euro 5/EEV/OBD2>	10.07→					<b>0 445 020 075</b>	<b>0 986 437 350</b>
			D 2066 LF51 <Euro 5/OBD2>	10.09→				<b>0 445 020 090</b>		
18.440	10,5	324	D 2066 LF17 <Euro 5/OBD1>; D 2066 LF25 <Euro 5/OBD1>; D 2066 LF36 <Euro 4/OBD1>; D 2066 LF40 <Euro 5/OBD2>; D 2066 LF57 <Euro 5/EEV/OBD2>	10.07→					<b>0 445 020 075</b>	<b>0 986 437 350</b>
			D 2676 LF22 <Euro 5/OBD2>	10.09→				<b>0 445 020 090</b>		
18.480 , F, FL	12,4	353	D 2676 LF05 <Euro 4/OBD1>; D 2676 LF07 <Euro 5/OBD2>; D 2676 LF14 <Euro 5/OBD1>; D 2676 LF16 <Euro 5/OBD1>; D 2676 LF18 <Euro 5/EEV/OBD2>	10.07→					<b>0 445 020 075</b>	<b>0 986 437 350</b>
			D 2676 LF06 <Euro 5/OBD2>; D 2676 LF13 <Euro 5/OBD1>; D 2676 LF15 <Euro 5/OBD1>	10.07→				<b>0 445 020 075</b>	<b>0 986 437 350</b>	
19.350 WW	10,5	257	D 2066 LF03 <Euro 3>	01.10→					<b>0 445 020 023</b>	<b>0 986 437 351</b>
19.360 WW	10,5	265	D 2066 LF07 <Euro 2>	01.10→					<b>0 445 020 023</b>	<b>0 986 437 351</b>
			D 2066 LF64 <Euro 4/OBD2>	02.11→				<b>0 445 020 075</b>	<b>0 986 437 350</b>	
19.390 WW	10,5	287	D 2066 LF02 <Euro 3>	01.10→					<b>0 445 020 023</b>	<b>0 986 437 351</b>
19.400 WW	10,5	294	D 2066 LF49 <Euro 3>; D 2066 LF63 <Euro 4/OBD2>	02.11→					<b>0 445 020 075</b>	<b>0 986 437 350</b>
			294/316 D 2066 LF01 <Euro 3>; D 2066 LF06 <Euro 2>	01.10→				<b>0 445 020 023</b>	<b>0 986 437 351</b>	
19.440 WW	10,5	324	D 2066 LF50 <Euro 3>; D 2066 LF62 <Euro 4/OBD2>	02.11→					<b>0 445 020 075</b>	<b>0 986 437 350</b>
			12,4 324/353 D 2676 LF02 <Euro 3>; D 2676 LF03 <Euro 2>; D 2676 LF04 <Euro 2>	01.10→				<b>0 445 020 075</b>	<b>0 986 437 350</b>	
19.480 WW	12,4	353	D 2676 LF20 <Euro 4/OBD2>	02.11→					<b>0 445 020 075</b>	<b>0 986 437 350</b>
24.320	10,5	235	D 2066 LF20 <Euro 5/OBD1>; D 2066 LF28 <Euro 5/OBD1>; D 2066 LF39 <Euro 4/OBD1>; D 2066 LF43 <Euro 5/OBD2>; D 2066 LF60 <Euro 5/EEV/OBD2>	10.07→					<b>0 445 020 075</b>	<b>0 986 437 350</b>
			D 2066 LF53 <Euro 5/OBD2>	10.09→				<b>0 445 020 090</b>		













◀ MAN

<b>24.360</b>	10,5	265	D 2066 LF19 <Euro 5/OBD1>; D 2066 LF27 <Euro 5/OBD1>; D 2066 LF38 <Euro 4/OBD1>; D 2066 LF42 <Euro 5/OBD2>; D 2066 LF59 <Euro 5/EEV/OBD2>	10.07→	<b>0 445 020 075</b>	<b>0 986 437 350</b>
			D 2066 LF52 <Euro 5/OBD2>	10.09→	<b>0 445 020 090</b>	
<b>24.400</b>	10,5	294	D 2066 LF18 <Euro 5/OBD1>; D 2066 LF26 <Euro 5/OBD1>; D 2066 LF37 <Euro 4/OBD1>; D 2066 LF41 <Euro 5/OBD2>; D 2066 LF58 <Euro 5/EEV/OBD2>	10.07→	<b>0 445 020 075</b>	<b>0 986 437 350</b>
			D 2066 LF51 <Euro 5/OBD2>	10.09→	<b>0 445 020 090</b>	
<b>24.440</b>	10,5	324	D 2066 LF17 <Euro 5/OBD1>; D 2066 LF25 <Euro 5/OBD1>; D 2066 LF36 <Euro 4/OBD1>; D 2066 LF40 <Euro 5/OBD2>; D 2066 LF57 <Euro 5/EEV/OBD2>	10.07→	<b>0 445 020 075</b>	<b>0 986 437 350</b>
	12,4	324	D 2676 LF22 <Euro 5/OBD2>	10.09→	<b>0 445 020 090</b>	
<b>24.480</b> , DF	12,4	353	D 2676 LF05 <Euro 4/OBD1>; D 2676 LF07 <Euro 5/OBD2>; D 2676 LF14 <Euro 5/OBD1>; D 2676 LF16 <Euro 5/OBD1>; D 2676 LF18 <Euro 5/EEV/OBD2>	10.07→	<b>0 445 020 075</b>	<b>0 986 437 350</b>
<b>24.540</b>	12,4	397	D 2676 LF06 <Euro 5/OBD2>	09.09→	<b>0 445 020 075</b>	<b>0 986 437 350</b>
<b>26.320</b>	10,5	235	D 2066 LF20 <Euro 5/OBD1>; D 2066 LF28 <Euro 5/OBD1>; D 2066 LF39 <Euro 4/OBD1>; D 2066 LF43 <Euro 5/OBD2>; D 2066 LF60 <Euro 5/EEV/OBD2>	10.07→	<b>0 445 020 075</b>	<b>0 986 437 350</b>
			D 2066 LF53 <Euro 5/OBD2>	10.09→	<b>0 445 020 090</b>	
<b>26.350</b> WW	10,5	257	D 2066 LF03 <Euro 3>	01.10→	<b>0 445 020 023</b>	<b>0 986 437 351</b>
<b>26.360</b>	10,5	265	D 2066 LF19 <Euro 5/OBD1>; D 2066 LF27 <Euro 5/OBD1>; D 2066 LF38 <Euro 4/OBD1>; D 2066 LF42 <Euro 5/OBD2>; D 2066 LF59 <Euro 5/EEV/OBD2>	10.07→	<b>0 445 020 075</b>	<b>0 986 437 350</b>
			D 2066 LF52 <Euro 5/OBD2>	10.09→	<b>0 445 020 090</b>	
WW	10,5	265	D 2066 LF64 <Euro 4/OBD2>	02.11→	<b>0 445 020 075</b>	<b>0 986 437 350</b>
<b>26.390</b> WW	10,5	287	D 2066 LF02 <Euro 3>	01.10→	<b>0 445 020 023</b>	<b>0 986 437 351</b>
<b>26.400</b>	10,5	294	D 2066 LF18 <Euro 5/OBD1>; D 2066 LF26 <Euro 5/OBD1>; D 2066 LF37 <Euro 4/OBD1>; D 2066 LF41 <Euro 5/OBD2>; D 2066 LF58 <Euro 5/EEV/OBD2>	10.07→	<b>0 445 020 075</b>	<b>0 986 437 350</b>
			D 2066 LF51 <Euro 5/OBD2>	10.09→	<b>0 445 020 090</b>	
WW	10,5	294	D 2066 LF49 <Euro 3>; D 2066 LF63 <Euro 4/OBD2>	02.11→	<b>0 445 020 075</b>	<b>0 986 437 350</b>
<b>26.430</b> WW	10,5	316	D 2066 LF01 <Euro 3>	01.10→	<b>0 445 020 023</b>	<b>0 986 437 351</b>
<b>26.440</b>	12,4	324	D 2676 LF22 <Euro 5/OBD2>	10.09→	<b>0 445 020 090</b>	
, WW	10,5	324	D 2066 LF17 <Euro 5/OBD1>; D 2066 LF25 <Euro 5/OBD1>; D 2066 LF36 <Euro 4/OBD1>; D 2066 LF40 <Euro 5/OBD2>; D 2066 LF50 <Euro 3>; D 2066 LF57 <Euro 5/EEV/OBD2>; D 2066 LF62 <Euro 4/OBD2>	10.07→	<b>0 445 020 075</b>	<b>0 986 437 350</b>
<b>26.480</b> , WW	12,4	353	D 2676 LF02 <Euro 3>; D 2676 LF05 <Euro 4/OBD1>; D 2676 LF07 <Euro 5/OBD2>; D 2676 LF14 <Euro 5/OBD1>; D 2676 LF16 <Euro 5/OBD1>; D 2676 LF18 <Euro 5/EEV/OBD2>; D 2676 LF20 <Euro 4/OBD2>	10.07→	<b>0 445 020 075</b>	<b>0 986 437 350</b>
<b>26.540</b>	12,4	397	D 2676 LF06 <Euro 5/OBD2>; D 2676 LF13 <Euro 5/OBD1>; D 2676 LF15 <Euro 5/OBD1>	10.07→	<b>0 445 020 075</b>	<b>0 986 437 350</b>
<b>28.320</b>	10,5	235/236	D 2066 LF20 <Euro 5/OBD1>; D 2066 LF28 <Euro 5/OBD1>; D 2066 LF39 <Euro 4/OBD1>; D 2066 LF43 <Euro 5/OBD2>; D 2066 LF60 <Euro 5/EEV/OBD2>	09.07→	<b>0 445 020 075</b>	<b>0 986 437 350</b>
<b>28.350</b> WW	10,5	257	D 2066 LF03 <Euro 3>	04.10→	<b>0 445 020 023</b>	<b>0 986 437 351</b>
<b>28.360</b> , WW	10,5	265	D 2066 LF19 <Euro 5/OBD1>; D 2066 LF27 <Euro 5/OBD1>; D 2066 LF38 <Euro 4/OBD1>; D 2066 LF42 <Euro 5/OBD2>; D 2066 LF59 <Euro 5/EEV/OBD2>; D 2066 LF64 <Euro 4/OBD2>	09.07→	<b>0 445 020 075</b>	<b>0 986 437 350</b>
<b>28.390</b> WW	10,5	287	D 2066 LF02 <Euro 3>	04.10→	<b>0 445 020 023</b>	<b>0 986 437 351</b>





								
28.400 , WW	10,5	294	D 2066 LF18 <Euro 5/OBD1>; D 2066 LF26 <Euro 5/OBD1>; D 2066 LF37 <Euro 4/OBD1>; D 2066 LF41 <Euro 5/OBD2>; D 2066 LF49 <Euro 3>; D 2066 LF58 <Euro 5/EEV/OBD2>; D 2066 LF63 <Euro 4/OBD2>	09.07→			0 445 020 075	0 986 437 350
28.430 WW	10,5	316	D 2066 LF01 <Euro 3>	04.10→			0 445 020 023	0 986 437 351
28.440 , WW	10,5	324	D 2066 LF17 <Euro 5/OBD1>; D 2066 LF25 <Euro 5/OBD1>; D 2066 LF36 <Euro 4/OBD1>; D 2066 LF40 <Euro 5/OBD2>; D 2066 LF50 <Euro 3>; D 2066 LF57 <Euro 5/EEV/OBD2>; D 2066 LF62 <Euro 4/OBD2>	09.07→			0 445 020 075	0 986 437 350
28.480 , WW	12,4	353	D 2676 LF02 <Euro 3>; D 2676 LF05 <Euro 4/OBD1>; D 2676 LF07 <Euro 5/OBD2>; D 2676 LF14 <Euro 5/OBD1>; D 2676 LF16 <Euro 5/OBD1>; D 2676 LF18 <Euro 5/EEV/OBD2>; D 2676 LF20 <Euro 4/OBD2>	09.07→			0 445 020 075	0 986 437 350
28.540	12,4	397	D 2676 LF06 <Euro 5/OBD2>; D 2676 LF13 <Euro 5/OBD1>; D 2676 LF15 <Euro 5/OBD1>	09.07→			0 445 020 075	0 986 437 350
32.320	10,5	235	D 2066 LF20 <Euro 5/OBD1>; D 2066 LF28 <Euro 5/OBD1>; D 2066 LF39 <Euro 4/OBD1>; D 2066 LF43 <Euro 5/OBD2>; D 2066 LF60 <Euro 5/EEV/OBD2>	10.07→			0 445 020 075	0 986 437 350
32.360	10,5	265	D 2066 LF19 <Euro 5/OBD1>; D 2066 LF27 <Euro 5/OBD1>; D 2066 LF38 <Euro 4/OBD1>; D 2066 LF42 <Euro 5/OBD2>; D 2066 LF59 <Euro 5/EEV/OBD2>	10.07→			0 445 020 075	0 986 437 350
32.400	10,5	294	D 2066 LF18 <Euro 5/OBD1>; D 2066 LF26 <Euro 5/OBD1>; D 2066 LF37 <Euro 4/OBD1>; D 2066 LF41 <Euro 5/OBD2>; D 2066 LF58 <Euro 5/EEV/OBD2>	10.07→			0 445 020 075	0 986 437 350
32.440	10,5	324	D 2066 LF17 <Euro 5/OBD1>; D 2066 LF25 <Euro 5/OBD1>; D 2066 LF36 <Euro 4/OBD1>; D 2066 LF40 <Euro 5/OBD2>; D 2066 LF57 <Euro 5/EEV/OBD2>	10.07→			0 445 020 075	0 986 437 350
32.480	12,4	324	D 2676 LF22 <Euro 5/OBD2>	10.09→			0 445 020 090	
32.480	12,4	353	D 2676 LF05 <Euro 4/OBD1>; D 2676 LF07 <Euro 5/OBD2>; D 2676 LF14 <Euro 5/OBD1>; D 2676 LF16 <Euro 5/OBD1>; D 2676 LF18 <Euro 5/EEV/OBD2>	10.07→			0 445 020 075	0 986 437 350
33.320	10,5	235	D 2066 LF20 <Euro 5/OBD1>; D 2066 LF28 <Euro 5/OBD1>; D 2066 LF39 <Euro 4/OBD1>; D 2066 LF43 <Euro 5/OBD2>; D 2066 LF60 <Euro 5/EEV/OBD2>	10.07→			0 445 020 075	0 986 437 350
33.350 WW	10,5	257	D 2066 LF03 <Euro 3>	01.10→			0 445 020 023	0 986 437 351
33.360	10,5	265	D 2066 LF19 <Euro 5/OBD1>; D 2066 LF27 <Euro 5/OBD1>; D 2066 LF38 <Euro 4/OBD1>; D 2066 LF42 <Euro 5/OBD2>; D 2066 LF59 <Euro 5/EEV/OBD2>	10.07→			0 445 020 075	0 986 437 350
WW	10,5	265	D 2066 LF07 <Euro 2>	03.10→			0 445 020 023	0 986 437 351
33.390 WW	10,5	287	D 2066 LF64 <Euro 4/OBD2>	02.11→			0 445 020 075	0 986 437 350
33.400	10,5	294	D 2066 LF02 <Euro 3>	01.10→			0 445 020 023	0 986 437 351
33.400	10,5	294	D 2066 LF18 <Euro 5/OBD1>; D 2066 LF26 <Euro 5/OBD1>; D 2066 LF37 <Euro 4/OBD1>; D 2066 LF41 <Euro 5/OBD2>; D 2066 LF58 <Euro 5/EEV/OBD2>	10.07→			0 445 020 075	0 986 437 350
WW	10,5	294	D 2066 LF06 <Euro 2>	03.10→			0 445 020 023	0 986 437 351
33.430 WW	10,5	316	D 2066 LF49 <Euro 3>; D 2066 LF63 <Euro 4/OBD2>	02.11→			0 445 020 075	0 986 437 350
33.430 WW	10,5	316	D 2066 LF01 <Euro 3>	01.10→			0 445 020 023	0 986 437 351













◀ MAN

<b>33.440</b> , WW	10,5	324	D 2066 LF17 <Euro 5/OBD1>; D 2066 LF25 <Euro 5/OBD1>; D 2066 LF36 <Euro 4/OBD1>; D 2066 LF40 <Euro 5/OBD2>; D 2066 LF50 <Euro 3>; D 2066 LF57 <Euro 5/EEV/OBD2>; D 2066 LF62 <Euro 4/OBD2>	10.07→	<b>0 445 020 075</b>	<b>0 986 437 350</b>
WW	12,4	324	D 2676 LF04 <Euro 2>	03.10→	<b>0 445 020 075</b>	<b>0 986 437 350</b>
<b>33.480</b> , DF, WW	12,4	353	D 2676 LF02 <Euro 3>; D 2676 LF03 <Euro 2>; D 2676 LF05 <Euro 4/OBD1>; D 2676 LF07 <Euro 5/OBD2>; D 2676 LF14 <Euro 5/OBD1>; D 2676 LF16 <Euro 5/OBD1>; D 2676 LF18 <Euro 5/EEV/OBD2>; D 2676 LF20 <Euro 4/OBD2>	10.07→	<b>0 445 020 075</b>	<b>0 986 437 350</b>
<b>33.540</b>	12,4	397	D 2676 LF06 <Euro 5/OBD2>; D 2676 LF13 <Euro 5/OBD1>; D 2676 LF15 <Euro 5/OBD1>	10.07→	<b>0 445 020 075</b>	<b>0 986 437 350</b>
<b>35.320</b>	10,5	235	D 2066 LF20 <Euro 5/OBD1>; D 2066 LF28 <Euro 5/OBD1>; D 2066 LF39 <Euro 4/OBD1>; D 2066 LF43 <Euro 5/OBD2>; D 2066 LF60 <Euro 5/EEV/OBD2>	10.07→	<b>0 445 020 075</b>	<b>0 986 437 350</b>
			D 2066 LF53 <Euro 5/OBD2>	10.09→	<b>0 445 020 090</b>	
<b>35.360</b>	10,5	265	D 2066 LF19 <Euro 5/OBD1>; D 2066 LF27 <Euro 5/OBD1>; D 2066 LF38 <Euro 4/OBD1>; D 2066 LF42 <Euro 5/OBD2>; D 2066 LF59 <Euro 5/EEV/OBD2>	10.07→	<b>0 445 020 075</b>	<b>0 986 437 350</b>
			D 2066 LF52 <Euro 5/OBD2>	10.09→	<b>0 445 020 090</b>	
WW	10,5	265	D 2066 LF64 <Euro 4/OBD2>	02.11→	<b>0 445 020 075</b>	<b>0 986 437 350</b>
<b>35.390</b> WW	10,5	287	D 2066 LF02 <Euro 3>	06.10→	<b>0 445 020 023</b>	<b>0 986 437 351</b>
<b>35.400</b>	10,5	294	D 2066 LF18 <Euro 5/OBD1>; D 2066 LF26 <Euro 5/OBD1>; D 2066 LF37 <Euro 4/OBD1>; D 2066 LF41 <Euro 5/OBD2>; D 2066 LF58 <Euro 5/EEV/OBD2>	10.07→	<b>0 445 020 075</b>	<b>0 986 437 350</b>
			D 2066 LF51 <Euro 5/OBD2>	10.09→	<b>0 445 020 090</b>	
WW	10,5	294	D 2066 LF49 <Euro 3>; D 2066 LF63 <Euro 4/OBD2>	02.11→	<b>0 445 020 075</b>	<b>0 986 437 350</b>
<b>35.430</b> WW	10,5	316	D 2066 LF01 <Euro 3>	06.10→	<b>0 445 020 023</b>	<b>0 986 437 351</b>
<b>35.440</b>	12,4	324	D 2676 LF22 <Euro 5/OBD2>	10.09→	<b>0 445 020 090</b>	
, WW	10,5	324	D 2066 LF17 <Euro 5/OBD1>; D 2066 LF25 <Euro 5/OBD1>; D 2066 LF36 <Euro 4/OBD1>; D 2066 LF40 <Euro 5/OBD2>; D 2066 LF50 <Euro 3>; D 2066 LF57 <Euro 5/EEV/OBD2>; D 2066 LF62 <Euro 4/OBD2>	10.07→	<b>0 445 020 075</b>	<b>0 986 437 350</b>
<b>35.480</b> , WW	12,4	353	D 2676 LF02 <Euro 3>; D 2676 LF05 <Euro 4/OBD1>; D 2676 LF07 <Euro 5/OBD2>; D 2676 LF14 <Euro 5/OBD1>; D 2676 LF16 <Euro 5/OBD1>; D 2676 LF18 <Euro 5/EEV/OBD2>; D 2676 LF20 <Euro 4/OBD2>	10.07→	<b>0 445 020 075</b>	<b>0 986 437 350</b>
<b>35.540</b>	12,4	397	D 2676 LF06 <Euro 5/OBD2>; D 2676 LF13 <Euro 5/OBD1>; D 2676 LF15 <Euro 5/OBD1>	10.07→	<b>0 445 020 075</b>	<b>0 986 437 350</b>
<b>37.320</b>	10,5	235	D 2066 LF20 <Euro 5/OBD1>; D 2066 LF28 <Euro 5/OBD1>; D 2066 LF39 <Euro 4/OBD1>; D 2066 LF43 <Euro 5/OBD2>; D 2066 LF60 <Euro 5/EEV/OBD2>	10.07→	<b>0 445 020 075</b>	<b>0 986 437 350</b>
<b>37.360</b>	10,5	265	D 2066 LF19 <Euro 5/OBD1>; D 2066 LF27 <Euro 5/OBD1>; D 2066 LF38 <Euro 4/OBD1>; D 2066 LF42 <Euro 5/OBD2>; D 2066 LF59 <Euro 5/EEV/OBD2>	10.07→	<b>0 445 020 075</b>	<b>0 986 437 350</b>
<b>37.400</b>	10,5	294	D 2066 LF26 <Euro 5/OBD1>; D 2066 LF37 <Euro 4/OBD1>; D 2066 LF41 <Euro 5/OBD2>; D 2066 LF58 <Euro 5/EEV/OBD2>	10.07→	<b>0 445 020 075</b>	<b>0 986 437 350</b>
<b>37.440</b>	10,5	324	D 2066 LF17 <Euro 5/OBD1>; D 2066 LF25 <Euro 5/OBD1>; D 2066 LF36 <Euro 4/OBD1>; D 2066 LF40 <Euro 5/OBD2>; D 2066 LF57 <Euro 5/EEV/OBD2>	10.07→	<b>0 445 020 075</b>	<b>0 986 437 350</b>



									
<b>37.480</b>		12,4	353	D 2676 LF05 <Euro 4/OBD1>; D 2676 LF07 <Euro 5/OBD2>; D 2676 LF14 <Euro 5/OBD1>; D 2676 LF16 <Euro 5/OBD1>; D 2676 LF18 <Euro 5/EEV/OBD2>	10.07→			<b>0 445 020 075</b>	<b>0 986 437 350</b>
<b>37.540</b>		12,4	397	D 2676 LF06 <Euro 5/OBD2>; D 2676 LF13 <Euro 5/OBD1>; D 2676 LF15 <Euro 5/OBD1>	10.07→			<b>0 445 020 075</b>	<b>0 986 437 350</b>
<b>40.360 WW</b>		10,5	265	D 2066 LF07 <Euro 2> D 2066 LF64 <Euro 4/OBD2>	09.11→ 12.11→			<b>0 445 020 023</b>	<b>0 986 437 351</b>
<b>40.390 WW</b>		10,5	287	D 2066 LF02 <Euro 3>	03.10→			<b>0 445 020 023</b>	<b>0 986 437 351</b>
<b>40.400 WW</b>		10,5	294	D 2066 LF06 <Euro 2> D 2066 LF49 <Euro 3>; D 2066 LF63 <Euro 4/OBD2>	03.10→ 02.11→			<b>0 445 020 023</b>	<b>0 986 437 351</b>
<b>40.430 WW</b>		10,5	316	D 2066 LF01 <Euro 3>	03.10→			<b>0 445 020 023</b>	<b>0 986 437 351</b>
<b>40.440 WW</b>		10,5	324	D 2066 LF50 <Euro 3>; D 2066 LF62 <Euro 4/OBD2>	02.11→			<b>0 445 020 075</b>	<b>0 986 437 350</b>
		12,4	324	D 2676 LF04 <Euro 2>	03.10→			<b>0 445 020 075</b>	<b>0 986 437 350</b>
<b>40.480 WW</b>		12,4	353	D 2676 LF02 <Euro 3>; D 2676 LF03 <Euro 2>; D 2676 LF20 <Euro 4/OBD2>	03.10→			<b>0 445 020 075</b>	<b>0 986 437 350</b>
<b>41.320</b>		10,5	235	D 2066 LF20 <Euro 5/OBD1>; D 2066 LF28 <Euro 5/OBD1>; D 2066 LF39 <Euro 4/OBD1>; D 2066 LF43 <Euro 5/OBD2>; D 2066 LF60 <Euro 5/EEV/OBD2>	10.07→			<b>0 445 020 075</b>	<b>0 986 437 350</b>
<b>41.350 WW</b>		10,5	257	D 2066 LF03 <Euro 3>	01.10→			<b>0 445 020 023</b>	<b>0 986 437 351</b>
<b>41.360</b>		10,5	265	D 2066 LF19 <Euro 5/OBD1>; D 2066 LF27 <Euro 5/OBD1>; D 2066 LF38 <Euro 4/OBD1>; D 2066 LF42 <Euro 5/OBD2>; D 2066 LF59 <Euro 5/EEV/OBD2>	10.07→			<b>0 445 020 075</b>	<b>0 986 437 350</b>
WW		10,5	265	D 2066 LF07 <Euro 2> D 2066 LF64 <Euro 4/OBD2>	01.10→ 02.11→			<b>0 445 020 023</b>	<b>0 986 437 351</b>
<b>41.390 WW</b>		10,5	287	D 2066 LF02 <Euro 3>	01.10→			<b>0 445 020 023</b>	<b>0 986 437 351</b>
<b>41.400</b>		10,5	294	D 2066 LF18 <Euro 5/OBD1>; D 2066 LF26 <Euro 5/OBD1>; D 2066 LF37 <Euro 4/OBD1>; D 2066 LF41 <Euro 5/OBD2>; D 2066 LF58 <Euro 5/EEV/OBD2>	10.07→			<b>0 445 020 075</b>	<b>0 986 437 350</b>
WW		10,5	294	D 2066 LF06 <Euro 2> D 2066 LF49 <Euro 3>; D 2066 LF63 <Euro 4/OBD2>	01.10→ 02.11→			<b>0 445 020 023</b>	<b>0 986 437 351</b>
<b>41.430 WW</b>		10,5	316	D 2066 LF01 <Euro 3>	01.10→			<b>0 445 020 023</b>	<b>0 986 437 351</b>
<b>41.440 , WW</b>		10,5	324	D 2066 LF17 <Euro 5/OBD1>; D 2066 LF25 <Euro 5/OBD1>; D 2066 LF36 <Euro 4/OBD1>; D 2066 LF40 <Euro 5/OBD2>; D 2066 LF50 <Euro 3>; D 2066 LF57 <Euro 5/EEV/OBD2>; D 2066 LF62 <Euro 4/OBD2>	10.07→			<b>0 445 020 075</b>	<b>0 986 437 350</b>
WW		12,4	324	D 2676 LF04 <Euro 2>	01.10→			<b>0 445 020 075</b>	<b>0 986 437 350</b>
<b>41.480 , WW</b>		12,4	353	D 2676 LF02 <Euro 3>; D 2676 LF03 <Euro 2>; D 2676 LF05 <Euro 4/OBD1>; D 2676 LF07 <Euro 5/OBD2>; D 2676 LF14 <Euro 5/OBD1>; D 2676 LF16 <Euro 5/OBD1>; D 2676 LF18 <Euro 5/EEV/OBD2>; D 2676 LF20 <Euro 4/OBD2>	10.07→			<b>0 445 020 075</b>	<b>0 986 437 350</b>
<b>41.540</b>		12,4	397	D 2676 LF06 <Euro 5/OBD2>; D 2676 LF13 <Euro 5/OBD1>; D 2676 LF15 <Euro 5/OBD1>	10.07→			<b>0 445 020 075</b>	<b>0 986 437 350</b>
<b>TGX</b>									
<b>18.360</b>		10,5	265	D 2066 LF19 <Euro 5/OBD1>; D 2066 LF27 <Euro 5/OBD1>; D 2066 LF38 <Euro 4/OBD1>; D 2066 LF42 <Euro 5/OBD2>; D 2066 LF59 <Euro 5/EEV/OBD2>	10.07→			<b>0 445 020 075</b>	<b>0 986 437 350</b>
<b>18.400</b>		10,5	294	D 2066 LF18 <Euro 5/OBD1>; D 2066 LF26 <Euro 5/OBD1>; D 2066 LF37 <Euro 4/OBD1>; D 2066 LF41 <Euro 5/OBD2>; D 2066 LF58 <Euro 5/EEV/OBD2> D 2066 LF51 <Euro 5/OBD2>	10.07→ 10.09→			<b>0 445 020 075</b>	<b>0 986 437 350</b>
<b>18.440</b>		10,5	324	D 2066 LF17 <Euro 5/OBD1>; D 2066 LF25 <Euro 5/OBD1>; D 2066 LF36 <Euro 4/OBD1>; D 2066 LF40 <Euro 5/OBD2>; D 2066 LF57 <Euro 5/EEV/OBD2>	10.07→			<b>0 445 020 075</b>	<b>0 986 437 350</b>
		12,4	324	D 2676 LF22 <Euro 5/OBD2>	10.09→			<b>0 445 020 090</b>	





◀ MAN

<b>18.480</b> , F, FL	12,4	353	D 2676 LF05 <Euro 4/OBD1>; D 2676 LF07 <Euro 5/OBD2>; D 2676 LF14 <Euro 5/OBD1>; D 2676 LF16 <Euro 5/OBD1>; D 2676 LF18 <Euro 5/EEV/OBD2>	10.07→	<b>0 445 020 075</b>	<b>0 986 437 350</b>
<b>18.540</b>	12,4	397	D 2676 LF06 <Euro 5/OBD2>; D 2676 LF13 <Euro 5/OBD1>; D 2676 LF15 <Euro 5/OBD1>	10.07→	<b>0 445 020 075</b>	<b>0 986 437 350</b>
<b>18.680</b>	16,2	500	D 2868 LF02 <Euro 5/OBD1>; D 2868 LF05 <Euro 5/EEV/OBD2>	01.08→	<b>0 445 020 082</b>	
<b>24.360</b>	10,5	265	D 2066 LF19 <Euro 5/OBD1>; D 2066 LF27 <Euro 5/OBD1>; D 2066 LF38 <Euro 4/OBD1>; D 2066 LF42 <Euro 5/OBD2>; D 2066 LF59 <Euro 5/EEV/OBD2>	10.07→	<b>0 445 020 075</b>	<b>0 986 437 350</b>
<b>24.400</b>	10,5	294	D 2066 LF18 <Euro 5/OBD1>; D 2066 LF26 <Euro 5/OBD1>; D 2066 LF37 <Euro 4/OBD1>; D 2066 LF41 <Euro 5/OBD2>; D 2066 LF58 <Euro 5/EEV/OBD2>	10.07→	<b>0 445 020 075</b>	<b>0 986 437 350</b>
<b>24.440</b>	10,5	324	D 2066 LF17 <Euro 5/OBD1>; D 2066 LF25 <Euro 5/OBD1>; D 2066 LF36 <Euro 4/OBD1>; D 2066 LF40 <Euro 5/OBD2>; D 2066 LF57 <Euro 5/EEV/OBD2>	10.07→	<b>0 445 020 075</b>	<b>0 986 437 350</b>
<b>24.480</b>	12,4	324	D 2676 LF22 <Euro 5/OBD2>	10.09→	<b>0 445 020 090</b>	
<b>24.480</b>	12,4	353	D 2676 LF05 <Euro 4/OBD1>; D 2676 LF07 <Euro 5/OBD2>; D 2676 LF14 <Euro 5/OBD1>; D 2676 LF16 <Euro 5/OBD1>; D 2676 LF18 <Euro 5/EEV/OBD2>	10.07→	<b>0 445 020 075</b>	<b>0 986 437 350</b>
<b>24.540</b>	12,4	397	D 2676 LF06 <Euro 5/OBD2>	09.09→	<b>0 445 020 075</b>	<b>0 986 437 350</b>
<b>26.360</b>	10,5	265	D 2066 LF19 <Euro 5/OBD1>; D 2066 LF27 <Euro 5/OBD1>; D 2066 LF38 <Euro 4/OBD1>; D 2066 LF42 <Euro 5/OBD2>; D 2066 LF59 <Euro 5/EEV/OBD2>	10.07→	<b>0 445 020 075</b>	<b>0 986 437 350</b>
<b>26.400</b>	10,5	294	D 2066 LF18 <Euro 5/OBD1>; D 2066 LF26 <Euro 5/OBD1>; D 2066 LF37 <Euro 4/OBD1>; D 2066 LF41 <Euro 5/OBD2>; D 2066 LF58 <Euro 5/EEV/OBD2>	10.07→	<b>0 445 020 075</b>	<b>0 986 437 350</b>
<b>26.440</b>	10,5	324	D 2066 LF17 <Euro 5/OBD1>; D 2066 LF25 <Euro 5/OBD1>; D 2066 LF36 <Euro 4/OBD1>; D 2066 LF40 <Euro 5/OBD2>; D 2066 LF57 <Euro 5/EEV/OBD2>	10.07→	<b>0 445 020 075</b>	<b>0 986 437 350</b>
<b>26.480</b>	12,4	324	D 2676 LF22 <Euro 5/OBD2>	10.09→	<b>0 445 020 090</b>	
<b>26.480</b>	12,4	353	D 2676 LF05 <Euro 4/OBD1>; D 2676 LF07 <Euro 5/OBD2>; D 2676 LF14 <Euro 5/OBD1>; D 2676 LF16 <Euro 5/OBD1>; D 2676 LF18 <Euro 5/EEV/OBD2>	10.07→	<b>0 445 020 075</b>	<b>0 986 437 350</b>
<b>26.540</b>	12,4	397	D 2676 LF06 <Euro 5/OBD2>; D 2676 LF13 <Euro 5/OBD1>; D 2676 LF15 <Euro 5/OBD1>	10.07→	<b>0 445 020 075</b>	<b>0 986 437 350</b>
<b>28.360</b>	10,5	265	D 2066 LF19 <Euro 5/OBD1>; D 2066 LF27 <Euro 5/OBD1>; D 2066 LF38 <Euro 4/OBD1>; D 2066 LF42 <Euro 5/OBD2>; D 2066 LF59 <Euro 5/EEV/OBD2>	10.07→	<b>0 445 020 075</b>	<b>0 986 437 350</b>
<b>28.400</b>	10,5	294	D 2066 LF18 <Euro 5/OBD1>; D 2066 LF26 <Euro 5/OBD1>; D 2066 LF37 <Euro 4/OBD1>; D 2066 LF41 <Euro 5/OBD2>; D 2066 LF58 <Euro 5/EEV/OBD2>	10.07→	<b>0 445 020 075</b>	<b>0 986 437 350</b>
<b>28.440</b>	10,5	324	D 2066 LF17 <Euro 5/OBD1>; D 2066 LF25 <Euro 5/OBD1>; D 2066 LF36 <Euro 4/OBD1>; D 2066 LF40 <Euro 5/OBD2>; D 2066 LF57 <Euro 5/EEV/OBD2>	10.07→	<b>0 445 020 075</b>	<b>0 986 437 350</b>
<b>28.480</b>	12,4	353	D 2676 LF05 <Euro 4/OBD1>; D 2676 LF07 <Euro 5/OBD2>; D 2676 LF14 <Euro 5/OBD1>; D 2676 LF18 <Euro 5/EEV/OBD2>	10.07→	<b>0 445 020 075</b>	<b>0 986 437 350</b>



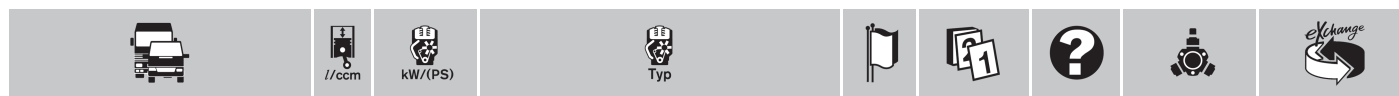

28.540	12,4	397	D 2676 LF06 <Euro 5/OBD2>; D 2676 LF13 <Euro 5/OBD1>; D 2676 LF15 <Euro 5/OBD1>	10.07→	0 445 020 075	0 986 437 350
33.360	10,5	265	D 2066 LF19 <Euro 5/OBD1>; D 2066 LF27 <Euro 5/OBD1>; D 2066 LF38 <Euro 4/OBD1>; D 2066 LF42 <Euro 5/OBD2>; D 2066 LF59 <Euro 5/EEV/OBD2>	10.07→	0 445 020 075	0 986 437 350
33.400	10,5	294	D 2066 LF18 <Euro 5/OBD1>; D 2066 LF26 <Euro 5/OBD1>; D 2066 LF37 <Euro 4/OBD1>; D 2066 LF41 <Euro 5/OBD2>; D 2066 LF58 <Euro 5/EEV/OBD2>	10.07→	0 445 020 075	0 986 437 350
33.440	10,5	324	D 2066 LF17 <Euro 5/OBD1>; D 2066 LF25 <Euro 5/OBD1>; D 2066 LF36 <Euro 4/OBD1>; D 2066 LF40 <Euro 5/OBD2>; D 2066 LF57 <Euro 5/EEV/OBD2>	10.07→	0 445 020 075	0 986 437 350
33.480 , DF	12,4	353	D 2676 LF05 <Euro 4/OBD1>; D 2676 LF07 <Euro 5/OBD2>; D 2676 LF14 <Euro 5/OBD1>; D 2676 LF16 <Euro 5/OBD1>; D 2676 LF18 <Euro 5/EEV/OBD2>	10.07→	0 445 020 075	0 986 437 350
33.540	12,4	397	D 2676 LF06 <Euro 5/OBD2>; D 2676 LF13 <Euro 5/OBD1>; D 2676 LF15 <Euro 5/OBD1>	10.07→	0 445 020 075	0 986 437 350
33.680	16,2	500	D 2868 LF02 <Euro 5/OBD1>; D 2868 LF05 <Euro 5/EEV/OBD2>	01.08→	0 445 020 082	
35.360	10,5	265	D 2066 LF19 <Euro 5/OBD1>; D 2066 LF27 <Euro 5/OBD1>; D 2066 LF38 <Euro 4/OBD1>; D 2066 LF42 <Euro 5/OBD2>; D 2066 LF59 <Euro 5/EEV/OBD2>	09.07→	0 445 020 075	0 986 437 350
35.400	10,5	294	D 2066 LF18 <Euro 5/OBD1>; D 2066 LF26 <Euro 5/OBD1>; D 2066 LF37 <Euro 4/OBD1>; D 2066 LF41 <Euro 5/OBD2>; D 2066 LF58 <Euro 5/EEV/OBD2>	09.07→	0 445 020 075	0 986 437 350
35.440	10,5	324	D 2066 LF17 <Euro 5/OBD1>; D 2066 LF25 <Euro 5/OBD1>; D 2066 LF36 <Euro 4/OBD1>; D 2066 LF40 <Euro 5/OBD2>; D 2066 LF57 <Euro 5/EEV/OBD2>	09.07→	0 445 020 075	0 986 437 350
35.480	12,4	353	D 2676 LF05 <Euro 4/OBD1>; D 2676 LF07 <Euro 5/OBD2>; D 2676 LF14 <Euro 5/OBD1>; D 2676 LF16 <Euro 5/OBD1>; D 2676 LF18 <Euro 5/EEV/OBD2>	09.07→	0 445 020 075	0 986 437 350
35.540	12,4	397	D 2676 LF06 <Euro 5/OBD2>; D 2676 LF13 <Euro 5/OBD1>; D 2676 LF15 <Euro 5/OBD1>	09.07→	0 445 020 075	0 986 437 350
41.540	12,4	397	D 2676 LF06 <Euro 5/OBD2>; D 2676 LF13 <Euro 5/OBD1>; D 2676 LF15 <Euro 5/OBD1>	10.07→	0 445 020 075	0 986 437 350
41.680	16,2	500	D 2868 LF03 <Euro 5/OBD1>; D 2868 LF06 <Euro 5/OBD2>	01.08→	0 445 020 082	

MAZ MINSK

## Serie 100

103	7,1	161,5/ 169	D 260.5 E2 <Euro 2>; D 260.5 E3 <Euro 3>	01.02→	0 445 020 087	
<b>10t</b>						
437041	4,8	115	D 245.30 E3 <Euro 3>	01.08→	0 445 020 088	
457043	4,8	115	D 245.30 E3 <Euro 3>	01.08→	0 445 020 088	
<b>13t</b>						
438043	4,8	130	D245.35 E4 <Euro 4>	12.11→	0 445 020 088	
<b>18t</b>						
5440A9	11,1	303	650.10 <Euro 3>	01.02→	0 445 020 086	
555147	7,1	169	D 260.5 E3 <Euro 3>	01.08→	0 445 020 087	





**MERCEDES-BENZ**

**Sprinter**

<b>208</b> CDI [T1N]	2,2	60	OM 611.987 DE LA	Mot.Nr. →..900359	04.00-05.06	<b>0 445 010 272</b>	<b>0 986 437 103</b>
				Mot.Nr. ...900360→	04.00-05.06	<b>0 445 010 268</b>	<b>0 986 437 100</b>
<b>209</b> CDI [NCV3]	2,1	65	OM 646.984 DE 22 LA <Euro 4>	Komp.Nr. 522612/08	04.06-03.09 TNK	<b>0 445 010 336</b>	<b>0 986 437 366</b>
				Mot.Nr. ...50 178027→	04.06-03.09 TNK	<b>0 445 010 346</b>	<b>0 986 437 364</b>
				Komp.Nr. 522612/03			
<b>211</b> CDI [NCV3]	2,1	80	OM 646.985 DE 22 LA <Euro 4>	Komp.Nr. 522612/08	04.06→ TNK	<b>0 445 010 336</b>	<b>0 986 437 366</b>
				Mot.Nr. ...50 178027→	04.06→ TNK	<b>0 445 010 346</b>	<b>0 986 437 364</b>
				Komp.Nr. 522612/03			
CDI [T1N]	2,2	80	OM 611.981 DE LA	Mot.Nr. →..900069	04.00-05.06	<b>0 445 010 272</b>	<b>0 986 437 103</b>
				Mot.Nr. ...900070→	04.00-05.06	<b>0 445 010 268</b>	<b>0 986 437 100</b>
<b>213</b> CDI [NCV3]	2,1	95	OM 646.986 DE 22 LA <Euro 4>	Komp.Nr. 522612/08	04.06-03.09 TNK	<b>0 445 010 336</b>	<b>0 986 437 366</b>
				Mot.Nr. ...50 178027→	04.06-03.09 TNK	<b>0 445 010 346</b>	<b>0 986 437 364</b>
				Komp.Nr. 522612/03			
CDI [T1N]	2,2	95	OM 611.981 DE LA	Mot.Nr. →..900069	04.00-05.06	<b>0 445 010 272</b>	<b>0 986 437 103</b>
				Mot.Nr. ...900070→	04.00-05.06	<b>0 445 010 268</b>	<b>0 986 437 100</b>
<b>215</b> CDI [NCV3]	2,1	110	OM 646... <Euro 4>		04.06→	<b>0 445 010 336</b>	<b>0 986 437 366</b>
<b>216</b> CDI [T1N]	2,7	115	OM 612.981 DE LA	Mot.Nr. →50 899863	04.00-05.06	<b>0 445 010 275</b>	<b>0 986 437 106</b>
				Mot.Nr. 50 899864→	04.00-05.06	<b>0 445 010 271</b>	<b>0 986 437 104</b>
<b>218</b> CDI [NCV3]	3,0	135	OM 642... <Euro 4>		04.06-03.09	<b>0 445 010 356</b>	<b>0 986 437 365</b>
<b>219</b> CDI [NCV3]	3,0	140	OM 642.992 DE 30 LA <Euro 5>		03.09→	<b>0 445 010 356</b>	<b>0 986 437 365</b>
<b>308</b> CDI [T1N]	2,2	60	OM 611.987 DE LA	Mot.Nr. →..900359	04.00-05.06	<b>0 445 010 272</b>	<b>0 986 437 103</b>
				Mot.Nr. ...900360→	04.00-05.06	<b>0 445 010 268</b>	<b>0 986 437 100</b>
<b>309</b> CDI [NCV3]	2,1	65	OM 646.984 DE 22 LA <Euro 4>	Komp.Nr. 522612/08	04.06-03.09 TNK	<b>0 445 010 336</b>	<b>0 986 437 366</b>
				Mot.Nr. ...50 178027→	04.06-03.09 TNK	<b>0 445 010 346</b>	<b>0 986 437 364</b>
				Komp.Nr. 522612/03			
<b>311</b> CDI	2,2	80	OM 611 LA	Komp.Nr. 522612/01	06.01-12.04	<b>0 445 010 272</b>	<b>0 986 437 103</b>
				Komp.Nr. 522612/06	06.01-12.04	<b>0 445 010 268</b>	<b>0 986 437 100</b>
CDI [NCV3]	2,1	80	OM 646.985 DE 22 LA <Euro 4>	Komp.Nr. 522612/08	04.06→ TNK	<b>0 445 010 336</b>	<b>0 986 437 366</b>
				Mot.Nr. ...50 178027→	04.06→ TNK	<b>0 445 010 346</b>	<b>0 986 437 364</b>
				Komp.Nr. 522612/03			
CDI [T1N]	2,1	80	OM 611.981 DE LA	Mot.Nr. →..900069	08.02-05.06	<b>0 445 010 272</b>	<b>0 986 437 103</b>
				Mot.Nr. ...900070→	08.02-05.06	<b>0 445 010 268</b>	<b>0 986 437 100</b>
	2,2	80	OM 611.981 DE LA	Mot.Nr. →..900069	04.00-05.06	<b>0 445 010 272</b>	<b>0 986 437 103</b>
				Mot.Nr. ...900070→	04.00-05.06	<b>0 445 010 268</b>	<b>0 986 437 100</b>
CDI Street	2,2	95	OM 611 LA	Komp.Nr. 522612/01	01.09→	<b>0 445 010 272</b>	<b>0 986 437 103</b>
				Komp.Nr. 522612/06	01.09→	<b>0 445 010 268</b>	<b>0 986 437 100</b>
<b>313</b> CDI	2,2	95	OM 611 LA	Komp.Nr. 522612/01	06.01→	<b>0 445 010 272</b>	<b>0 986 437 103</b>
				Komp.Nr. 522612/06	06.01→	<b>0 445 010 268</b>	<b>0 986 437 100</b>
CDI [NCV3]	2,1	95	OM 646.986 DE 22 LA <Euro 4>	Komp.Nr. 522612/08	04.06-03.09 TNK	<b>0 445 010 336</b>	<b>0 986 437 366</b>
				Mot.Nr. ...50 178027→	04.06-03.09 TNK	<b>0 445 010 346</b>	<b>0 986 437 364</b>
				Komp.Nr. 522612/03			





<b>313</b> CDI [T1N]	2,2	95	OM 611.981 DE LA				
			Mot.Nr. →..900069	04.00-05.06		<b>0 445 010 272</b>	<b>0 986 437 103</b>
			Mot.Nr. →..900359	08.02-05.06		<b>0 445 010 272</b>	<b>0 986 437 103</b>
			Mot.Nr. ..900070→	04.00-05.06		<b>0 445 010 268</b>	<b>0 986 437 100</b>
			Mot.Nr. ..900360→	08.02-05.06		<b>0 445 010 268</b>	<b>0 986 437 100</b>
<b>315</b> CDI [NCV3]	2,1	110	OM 646... <Euro 4>	04.06→		<b>0 445 010 336</b>	<b>0 986 437 366</b>
<b>316</b> CDI [T1N]	2,7	115	OM 647.981 DE 27 LA	10.04-05.06		<b>0 445 010 346</b>	<b>0 986 437 364</b>
CDI, CDI James Cook [T1N]	2,7	115	OM 612.981 DE LA				
			Mot.Nr. →50 899863	04.00-05.06		<b>0 445 010 275</b>	<b>0 986 437 106</b>
			Mot.Nr. 50 899864→	04.00-05.06		<b>0 445 010 271</b>	<b>0 986 437 104</b>
<b>318</b> CDI [NCV3]	3,0	135	OM 642... <Euro 4>	04.06-03.09		<b>0 445 010 356</b>	<b>0 986 437 365</b>
<b>319</b> CDI [NCV3]	3,0	140	OM 642.992 DE 30 LA <Euro 5>	03.09→		<b>0 445 010 356</b>	<b>0 986 437 365</b>
<b>408</b> CDI [T1N]	2,2	60	OM 611.987 DE LA				
			Mot.Nr. →..900359	04.00-05.06		<b>0 445 010 272</b>	<b>0 986 437 103</b>
			Mot.Nr. ..900360→	04.00-05.06		<b>0 445 010 268</b>	<b>0 986 437 100</b>
<b>411</b> CDI [NCV3]	2,1	80	OM 646.985 DE 22 LA <Euro 4>				
			Komp.Nr. 522612/08	04.06-03.09 TNK		<b>0 445 010 336</b>	<b>0 986 437 366</b>
			Mot.Nr. ..50 178027→	04.06-03.09 TNK		<b>0 445 010 346</b>	<b>0 986 437 364</b>
			Komp.Nr. 522612/03				
CDI [T1N]	2,2	80	OM 611.981 DE LA				
			Mot.Nr. →..900069	04.00-05.06		<b>0 445 010 272</b>	<b>0 986 437 103</b>
			Mot.Nr. ..900070→	04.00-05.06		<b>0 445 010 268</b>	<b>0 986 437 100</b>
<b>413</b> CDI	2,2	95	OM 611 LA				
			Komp.Nr. 522612/01	06.01→		<b>0 445 010 272</b>	<b>0 986 437 103</b>
			Komp.Nr. 522612/06	06.01→		<b>0 445 010 268</b>	<b>0 986 437 100</b>
CDI [T1N]	2,2	95	OM 611.981 DE LA				
			Mot.Nr. →..900069	04.00-05.06		<b>0 445 010 272</b>	<b>0 986 437 103</b>
			Mot.Nr. ..900070→	04.00-05.06		<b>0 445 010 268</b>	<b>0 986 437 100</b>
<b>415</b> CDI [NCV3]	2,1	110	OM 646... <Euro 4>	04.06-03.09		<b>0 445 010 336</b>	<b>0 986 437 366</b>
<b>416</b> CDI [T1N]	2,7	115	OM 612.981 DE LA				
			Mot.Nr. →50 899863	04.00-05.06		<b>0 445 010 275</b>	<b>0 986 437 106</b>
			Mot.Nr. 50 899864→	04.00-05.06		<b>0 445 010 271</b>	<b>0 986 437 104</b>
			OM 647.981 DE 27 LA	10.04-05.06		<b>0 445 010 346</b>	<b>0 986 437 364</b>
<b>418</b> CDI [NCV3]	3,0	135	OM 642... <Euro 4>	04.06-03.09		<b>0 445 010 356</b>	<b>0 986 437 365</b>
<b>419</b> CDI [NCV3]	3,0	140	OM 642.992 DE 30 LA <Euro 5>	03.09→		<b>0 445 010 356</b>	<b>0 986 437 365</b>
<b>509</b> CDI [NCV3]	2,1	65	OM 646.984 DE 22 LA <Euro 4>				
			Komp.Nr. 522612/08	04.06-03.09 TNK		<b>0 445 010 336</b>	<b>0 986 437 366</b>
			Mot.Nr. ..50 178027→	04.06-03.09 TNK		<b>0 445 010 346</b>	<b>0 986 437 364</b>
			Komp.Nr. 522612/03				
<b>511</b> CDI [NCV3]	2,1	80	OM 646.985 DE 22 LA <Euro 4>				
			Komp.Nr. 522612/08	04.06-03.09 TNK		<b>0 445 010 336</b>	<b>0 986 437 366</b>
			Mot.Nr. ..50 178027→	04.06-03.09 TNK		<b>0 445 010 346</b>	<b>0 986 437 364</b>
			Komp.Nr. 522612/03				
<b>515</b> CDI [NCV3]	2,1	110	OM 646... <Euro 4>				
			Mot.Nr. ..50 178027→	04.06-03.09		<b>0 445 010 346</b>	<b>0 986 437 364</b>
			Mot. Typ 646.986				
			Mot. Typ 646.990	04.06-03.09		<b>0 445 010 336</b>	<b>0 986 437 366</b>
<b>518</b> CDI [NCV3]	3,0	135	OM 642... <Euro 4>	04.06-03.09		<b>0 445 010 356</b>	<b>0 986 437 365</b>
<b>519</b> CDI [NCV3]	3,0	140	OM 642.992 DE 30 LA <Euro 5>	03.09→		<b>0 445 010 356</b>	<b>0 986 437 365</b>
<b>616</b> CDI [T1N]	2,7	115	OM 612.981 DE LA				
			Mot.Nr. →50 899863	02.01-05.06		<b>0 445 010 275</b>	<b>0 986 437 106</b>
			Mot.Nr. 50 899864→	02.01-05.06		<b>0 445 010 271</b>	<b>0 986 437 104</b>
<b>Vito</b>							
<b>108</b> CDI [638 TON]	2,2	60	OM 611.980	04.99-09.03		<b>0 445 010 269</b>	<b>0 986 437 101</b>
<b>109</b> CDI [639 TON]	2,1	65	OM 646.983 <OM 646 DE22LA>				
			Mot.Nr. ..50 178027→	10.03-10.06		<b>0 445 010 346</b>	<b>0 986 437 364</b>
		70	OM 646.980 <OM 646 DE22LA>				
			Komp.Nr. 522612/08	11.06-07.10 TNK		<b>0 445 010 336</b>	<b>0 986 437 366</b>
			Mot.Nr. ..50 178027→	11.06-07.10 TNK		<b>0 445 010 346</b>	<b>0 986 437 364</b>
			Komp.Nr. 522612/03				
<b>110</b> CDI [638 TON]	2,2	75	OM 611.980	04.99-09.03		<b>0 445 010 269</b>	<b>0 986 437 101</b>





◀ MERCEDES-BENZ

<b>111</b> CDI [639 TON]	2,1	80/85	OM 646.981 <OM 646 DE22LA>; OM 646.982 <OM 646 DE22LA> Mot.Nr. ...50 178027→	10.03-07.10		<b>0 445 010 346</b>	<b>0 986 437 364</b>
<b>112</b> CDI [638 TON]	2,2	90	OM 611.980	04.99-09.03		<b>0 445 010 269</b>	<b>0 986 437 101</b>
<b>115</b> CDI [639 TON]	2,1	110	OM 646.982 <OM 646 DE22LA> Mot.Nr. ...50 178027→	10.03-07.10		<b>0 445 010 346</b>	<b>0 986 437 364</b>
<b>120</b> CDI [639 TON]	3,0	150	642.990 <OM 642 DE30LA>	04.06-07.10	WAS	<b>0 445 010 356</b>	<b>0 986 437 365</b>
					WAS	<b>0 445 010 345</b>	<b>0 986 437 363</b>
<b>122</b> CDI [639 TON]	3,0	165	OM 642 DE 30 LA <Euro 5>	07.10→	WAS	<b>0 445 010 356</b>	<b>0 986 437 365</b>
					WAS	<b>0 445 010 345</b>	<b>0 986 437 363</b>

**mitsubishi**

<b>Canter 35</b>							
<b>3C</b> 11, 13, 15 [FB]	3,0	81/92/ 107	4M42-T1 <Euro 4>; 4M42-T2 <Euro 4>; 4M42-T4 <Euro 4>	04.06→		<b>0 445 020 049</b>	
<b>3S</b> 11, 13 [FE]	3,0	81/92	4M42-T1 <Euro 4>; 4M42-T2 <Euro 4>	04.06→		<b>0 445 020 049</b>	
<b>Canter 55</b>							
<b>5S</b> 13 [FE]	3,0	92	4M42-3A T2 <Euro 4>	04.06→		<b>0 445 020 049</b>	
<b>Canter 65</b>							
<b>6C</b> 15 [FE]	3,0	107	4M42-3A T4 <Euro 4>	04.06→		<b>0 445 020 049</b>	
18 [FE]	4,9	132	4M50-T5 <Euro 4>	08.06→		<b>0 445 020 050</b>	
<b>Canter 75</b>							
<b>7C</b> 15 [FE]	3,0	107	4M42-3A T4 <Euro 4>	04.06→		<b>0 445 020 049</b>	
18 [FE]	4,9	132	4M50-T5 <Euro 4>	08.06→		<b>0 445 020 050</b>	

**MITSUBISHI FUSO TRUCK & BUS CO**

<b>Canter</b>							
<b>3.0</b> D Turbo	3,0	81/92/ 107	4M42-3AT1 <Euro 4>; 4M42-3AT2 <Euro 4>; 4M42-3AT4 <Euro 4>	04.06→		<b>0 445 020 049</b>	
<b>4.9</b> D Turbo	4,9	110	4M50-7AT7 <Euro 3>	11.09→		<b>0 445 020 028</b>	
		132	4M50-T5 <Euro 4>	04.06→		<b>0 445 020 050</b>	

**MZKT**

<b>42t</b>							
<b>700600</b>	11,1	303	650.10 <Euro 3>	01.10→		<b>0 445 020 086</b>	

**NEFAZ NEFTEKAMSK**

<b>Serie 5000</b>							
<b>5297</b>	5,9	184	6ISBe 250.30 <Euro 3>	01.00→	TW	<b>0 445 020 007</b>	<b>0 986 437 341</b>
						<b>0 445 020 045</b>	<b>0 986 437 342</b>
<b>5299</b>	6,7	184	6ISBe 250.30 <Euro 3>	01.08→	TW	<b>0 445 020 007</b>	<b>0 986 437 341</b>
						<b>0 445 020 045</b>	<b>0 986 437 342</b>
		198	6ISBe 270B <Euro 3>	01.08→	TW	<b>0 445 020 007</b>	<b>0 986 437 341</b>
						<b>0 445 020 045</b>	<b>0 986 437 342</b>

**NEOPLAN**

<b>Trendliner</b>							
<b>N 3516..</b>	10,5	228	D 2066 LUH01 <Euro 4>	01.06-03.10		<b>0 445 020 075</b>	<b>0 986 437 350</b>







## NISSAN

## Atleon

3.0	3,0	110	ZD30Kai	09.09→	0 445 010 257
-----	-----	-----	---------	--------	---------------

## Cabstar

3.0 D Turbo [F24]	3,0	110	ZD30DDTI	09.06-06.08	0 445 010 136	0 986 437 031	
				07.08→	3T5	0 445 010 136	0 986 437 031
					4T5, MG5	0 445 010 195	
					4T5, MG6	0 445 010 136	0 986 437 031

## Interstar

1.9 D Turbo dCi 80 [X70]	1,9	59-60	F9Q...	07.02→	0 445 010 075	0 986 437 301
2.2 D Turbo dCi 90 [X70]	2,2	66	G9T...	07.02→	0 445 010 033	0 986 437 302
2.5 D Turbo dCi 100 [X70]	2,5	73-74	G9U...			
			Mot.Nr. G9U 650	11.03-09.07	0 445 010 140	0 986 437 033
				10.07→	0 445 010 295	0 986 437 039
			Mot.Nr. G9U 754	11.03→	0 445 010 033	0 986 437 302
D Turbo dCi 120 [X70]	2,5	84-88	G9U...			
			Mot.Nr. G9U 632	07.02-09.07	0 445 010 140	0 986 437 033
			Mot.Nr. G9U 650	10.07→	0 445 010 295	0 986 437 039
			Mot.Nr. G9U 720	07.02→	0 445 010 033	0 986 437 302
			Mot.Nr. G9U 724			
			Mot.Nr. G9U 750			
			Mot.Nr. G9U 754			

3.0 D Turbo dCi 140 [X70]	3,0	99-100	ZD3	11.03→	0 445 020 024
---------------------------	-----	--------	-----	--------	---------------

## Primastar

1.9 dCi 80, dCi 100 [X83]	1,9	59-60/74	F9Q 760; F9Q 762	07.02→	0 445 010 075	0 986 437 301
2.0 dCi 90, dCi 115 [X83]	2,0	66/84-85	M9R...			
			Mot.Nr. M9R 780	10.06→	0 445 010 099	0 986 437 355
			Mot.Nr. M9R 782	10.06-11.08	0 445 010 170	0 986 437 037
				12.08→	0 445 010 223	0 986 437 044
2.5 dCi 140 [X83]	2,5	99	G9U 730	09.03→	0 445 010 033	0 986 437 302
dCi 150 [X83]	2,5	107-110	G9U 630	10.06-12.07	0 445 010 140	0 986 437 033
				01.08→	0 445 010 295	0 986 437 039

## OPEL

## Movano

1.9 DTI [A]	1,9	60	F9Q-77... <EEC99/102A>	10.01-10.05	0 445 010 075	0 986 437 301
2.2 DTI [A]	2,2	66	G9T-7... <ECC99/102A>; G9T-720 <EEC96/69>	09.00-10.05	0 445 010 033	0 986 437 302
2.5 DTI [A]	2,5	73-74/84	G9U-7... <ECC99/102A>; G9U-754 <ECC99/102A>	10.01-03.10	0 445 010 033	0 986 437 302

## Vivaro

1.9 CDTI, DTI	1,9	60/74	F9Q-760; F9Q-762	03.01-08.06	0 445 010 075	0 986 437 301
2.5 CDTI	2,5	99	G9U-730 <Turbo>	09.02-08.06	0 445 010 033	0 986 437 302

## PAZ PAVLOVO

## Serie 3000

3237	3,9	110	ISBe 150.30 <Euro 3>	01.00→	0 445 020 007	0 986 437 341
-03, -09	4,5	117,7/136	4ISBe 160B <Euro 3>; 4ISBe 185B <Euro 3>	06.09→	0 445 020 045	0 986 437 342

## Serie 4000

4230	4,5	136	4ISBe 185B <Euro 3>	06.09→	0 445 020 045	0 986 437 342
4234	4,8	100/110	D 245.9 E3 <Euro 3>; D 245.9 E4 <Euro 4>	01.08→	0 445 020 088	

## Serie 32000

32053	4,8	100/110	D 245.9 E3 <Euro 3>; D 245.9 E4 <Euro 2>	01.08→	0 445 020 088	
-------	-----	---------	--	--------	---------------	--

## Serie 320000

320301 -03	4,5	136	4ISBe 185B <Euro 3>	06.09→	0 445 020 045	0 986 437 342
------------	-----	-----	---------------------	--------	---------------	---------------





**PEUGEOT**

Boxer							
2.0 HDi [U3]	2,0	62	RHV <DW10TD>		09.01-02.02	0 445 010 046	0 986 437 017
HDi [U5]	2,0	62	RHV <DW10TD>		02.02-05.06	0 445 010 046	0 986 437 017
2.2 HDi [U5]	2,2	74	4HY <DW12TED>		02.02-05.06	0 445 010 046	0 986 437 017
2.8 HDi [U3]	2,8	94	8140 43s <SOFIM 2800 HDi>		09.00-02.02	0 445 020 002	0 986 437 501
HDi [U5]	2,8	94	8140 43s <SOFIM 2800 HDi>		02.02-05.06	0 445 020 002	0 986 437 501
HDI	2,8	93	8140 43s		09.05-09.09	0 445 020 002	0 986 437 501

**RENAULT**

Kerax							
270	11,1	195	dCi 11 I <Euro 3>				
			Mot.Nr. →83MO610300		01.01-03.04	0 445 020 012	
			Mot.Nr. 83MO610301→		04.04-04.06	0 445 020 035	
320	11,1	230	dCi 11 G <Euro 3>				
			Mot.Nr. →83MO610300		01.01-03.04	0 445 020 012	
			Mot.Nr. 83MO610301→		04.04-04.06	0 445 020 035	
370	11,1	266	dCi 11 E <Euro 3>				
			Mot.Nr. →83MO610300		01.01-03.04	0 445 020 012	
			Mot.Nr. 83MO610301→		04.04-04.06	0 445 020 035	
420	11,1	303	dCi 11 C <Euro 3>				
			Mot.Nr. →83MO610300		01.01-03.04	0 445 020 012	
			Mot.Nr. 83MO610301→		04.04-04.06	0 445 020 035	
Mascott							
110	2,8	78	8140.43B.3586/3588		01.01-06.04	0 445 020 002	0 986 437 501
120	3,0	85	DXi 3-120 ZD3 600		05.04-05.07	0 445 010 094	
130	2,8	92	8140.43S.2585; 8140.43S.3585		01.99-06.04	0 445 020 002	0 986 437 501
	3,0	96	DXi 3-130 <ZD30DDTI>		06.07→	0 445 010 136	0 986 437 031
150	3,0	110	DXi 3-150 <ZD30DDTI>		06.07→	0 445 010 136	0 986 437 031
160	3,0	115	DXi 3-160 ZD3 604		05.04-05.07	0 445 010 094	
Master							
1.9 dCi 80 [X70]	1,9	60	F9Q 772; F9Q 774		05.00-10.06	0 445 010 075	0 986 437 301
2.2 dCi 90 [X70]	2,2	66	G9T 720; G9T 722; G9T 750		01.00-10.06	0 445 010 033	0 986 437 302
2.3 dCi	2,3	74-92/ 107	M9T 6... <120CG/CH/CK>; M9T 672 <120CA/CB>; M9T 676 <120BX/BY>; M9T 678 <120BZ>; M9T 694 <120CJ> M9T 69... <120CD/CE/CL>; M9T 670 <120BU/BV>; M9T 680 <120BW/FY>; M9T 698 <120CF/CY>		02.10→  02.10→	0 445 010 351  0 455 010 234	0 986 437 041
2.5 dCi 16V [ADCU]	2,5	85	G9U-724		10.04→	0 445 010 033	0 986 437 302
dCi 90, dCi 100, dCi 110, dCi 120 [X70]	2,5	73/81/84	G9U 720; G9U 724; G9U 750; G9U 754		05.00-10.06	0 445 010 033	0 986 437 302
dCi 100	2,5	74	G9U 650 (M2) <120BN, Euro 4>		11.06-09.07 10.07-04.10	0 445 010 140 0 445 010 295	0 986 437 033 0 986 437 039
dCi 120	2,5	88	G9U 650 (M1) <120BO, Euro 4>		11.06-09.07 10.07-04.10	0 445 010 140 0 445 010 295	0 986 437 033 0 986 437 039
dCi 120 FAP	2,5	88	G9U 632 (M1) <120BQ, Euro 4>		11.06-09.07 10.07-04.10	0 445 010 140 0 445 010 295	0 986 437 033 0 986 437 039
dCi 150 FAP	2,5	107	G9U 632 (MY) <Euro 4>		11.06-09.07 10.07-04.10	0 445 010 140 0 445 010 295	0 986 437 033 0 986 437 039
3.0 dCi 140 [X70]	3,0	100	ZD3 200 <Euro 3>; ZD3 202 <Euro 3>		10.03-10.06	0 445 010 094	
Maxity							
150	3,0	110	DXi 3 150 <ZD30DDTI, Euro 4>		03.07→ TW	0 445 010 136	0 986 437 031
Midlum							
150	4,0	112	dCi 4B <Euro 3>		07.01-04.06	0 445 020 009	
180	4,0	128	dCi 4C <Euro 3>		07.01-04.06	0 445 020 009	
220 4x2, 4x4	6,2	158/162	dCi 6W <Euro 3>				
			Mot.Nr. →83MO6605194		07.01-04.06	0 445 020 012	
			Mot.Nr. 83MO6605195→		07.01-04.06	0 445 020 035	





<b>270</b>	6,2	195	dCI 6 A <Euro 3>					
			Mot.Nr. →83MO6605194		07.01-04.06		<b>0 445 020 012</b>	
			Mot.Nr. 83MO6605195→		07.01-04.06		<b>0 445 020 035</b>	
<b>Premium</b>								
<b>220</b> Distribution	6,2	158	dCI 6 W <Euro 3>					
			Mot.Nr. →83MO6605194		11.00-02.04		<b>0 445 020 012</b>	
			Mot.Nr. 83MO6605195→		03.04-04.06		<b>0 445 020 035</b>	
<b>270</b> Distribution, Lander	6,2	195	dCI 6 A <Euro 3>					
			Mot.Nr. →83MO6605194		11.00-02.04		<b>0 445 020 012</b>	
			Mot.Nr. 83MO6605195→		03.04-04.06		<b>0 445 020 035</b>	
<b>320</b> Distribution, Lander, Route	11,1	229	dCI 11 G <Euro 3>					
			Mot.Nr. →83MO610300		01.00-03.04		<b>0 445 020 012</b>	
			Mot.Nr. 83MO610301→		04.04-04.06		<b>0 445 020 035</b>	
<b>370</b> Distribution, Lander, Route	11,1	266	dCI 11 E <Euro 3>					
			Mot.Nr. →83MO610300		01.00-03.04		<b>0 445 020 012</b>	
			Mot.Nr. 83MO610301→		04.04-04.06		<b>0 445 020 035</b>	
<b>420</b> Distribution, Lander, Route	11,1	303	dCI 11 C <Euro 3>					
			Mot.Nr. →83MO610300		11.00-03.04		<b>0 445 020 012</b>	
			Mot.Nr. 83MO610301→		04.04-04.06		<b>0 445 020 035</b>	
Route	11,1	303	dCI 06.23.56 B43 <Euro 3>		01.00-09.01		<b>0 445 020 012</b>	
<b>Traffic</b>								
<b>1.9</b> DCI [EL./FL./JL.]	1,9	60/74	F9Q 760; F9Q 762		05.01-12.06		<b>0 445 010 075</b>	<b>0 986 437 301</b>
<b>2.0</b> DCI [EL./FL./JL.]	2,0	66	M9R 780		01.06-10.08		<b>0 445 010 170</b>	<b>0 986 437 037</b>
					11.08→		<b>0 445 010 223</b>	<b>0 986 437 044</b>
		66/84	M9R630		05.10→		<b>0 455 010 234</b>	
		85	M9R 780		01.06→		<b>0 445 010 099</b>	<b>0 986 437 355</b>
			M9R 782		01.06-10.08		<b>0 445 010 170</b>	<b>0 986 437 037</b>
					11.08→		<b>0 445 010 223</b>	<b>0 986 437 044</b>
<b>2.5</b> DCI [EL./FL./JL.]	2,5	98	G9U 730		06.02-12.06		<b>0 445 010 033</b>	<b>0 986 437 302</b>
		107	G9U 630		01.06-12.07		<b>0 445 010 140</b>	<b>0 986 437 033</b>
					01.08→		<b>0 445 010 295</b>	<b>0 986 437 039</b>

**TEMSA**
**Opalin**

<b>8</b>	4,6	152	D0834 LFL51/52 <Euro 4>		09.05→	EXW	<b>0 445 020 060</b>	<b>0 986 437 352</b>
<b>9</b>	6,9	176	D0836 LOH52 <Euro 4>		09.05→	EXW	<b>0 445 020 060</b>	<b>0 986 437 352</b>

**TONAR**
**24t**

<b>5422</b>	11,1	303	650.10 <Euro 3>		01.10→		<b>0 445 020 086</b>	
<b>6428</b>	11,1	303	650.10 <Euro 3>		01.10→		<b>0 445 020 086</b>	
<b>6528</b>	11,1	303	650.10 <Euro 3>		01.10→		<b>0 445 020 086</b>	

**URAL AUTOMOBIL PLANT**
**18t**

<b>6367-31</b>	11,1	266	6501.10 <Euro 3>		12.09→		<b>0 445 020 086</b>	
----------------	------	-----	------------------	--	--------	--	----------------------	--

**29t**

<b>6470</b>	11,1	303	650 DCi 11 <Euro 3>		01.08→		<b>0 445 020 086</b>	
-------------	------	-----	---------------------	--	--------	--	----------------------	--

**33t**

<b>63621</b>	11,1	303	650.10 <Euro 3>		01.08→		<b>0 445 020 086</b>	
--------------	------	-----	-----------------	--	--------	--	----------------------	--

<b>65685</b>	11,1	303	650 DCi 11 <Euro 3>		01.08→		<b>0 445 020 086</b>	
--------------	------	-----	---------------------	--	--------	--	----------------------	--

**41t**

<b>6563</b>	11,1	303	650 DCi 11 <Euro 3>		01.08→		<b>0 445 020 086</b>	
-------------	------	-----	---------------------	--	--------	--	----------------------	--





**VAUXHALL**

<b>Movano</b>						
1.9 DTI [A]	1,9	60	F9Q-772		10.01-10.05	<b>0 445 010 075 0 986 437 301</b>
			F9Q-774		10.01-10.05 TW	<b>0 445 010 075 0 986 437 301</b>
2.2 DTI [A]	2,2	66	G9T-720; G9T-722; G9T-750		01.01-10.05	<b>0 445 010 033 0 986 437 302</b>
2.5 DTI [A]	2,5	74-84	G9U-7... <Turbo>; G9U-75... <Turbo>; G9U-724		10.01-03.10	<b>0 445 010 033 0 986 437 302</b>
<b>Vivaro</b>						
1.9 DI, DTI	1,9	59-60/74	F9Q-760; F9Q-762		03.01-08.06	<b>0 445 010 075 0 986 437 301</b>
2.5 DTI	2,5	99	G9U-730 <Turbo>		04.04-08.06	<b>0 445 010 033 0 986 437 302</b>

**VW (VOLKSWAGEN)**

<b>California T5</b>						
2.0 TDI, TDI 4 Motion [7E]	2,0	62/75/84/ 100/103/ 132	CAAA <D54>; CAAB <D55>; CAAC <D94>; CAAD <DK3>; CAAE <D94>; CCHA <D91>; CCHB <D94>; CFCA <D49>		09.09->	<b>0 445 010 555</b>
<b>Caravelle T5</b>						
2.0 TDI, TDI 4 Motion [7E]	2,0	62/75/84/ 100/103/ 132	CAAA <D54>; CAAB <D55>; CAAC <D94>; CAAD <DK3>; CAAE <D94>; CCHA <D91>; CCHB <D94>; CFCA <D49>		09.09->	<b>0 445 010 555</b>
<b>Crafter 30</b>						
2.5 TDI [2E, 2F]	2,5	65/80/ 100/120	BJJ <D5K>; BJK <D5L>; BJL <D5M>; BJM <D5N>; CEBA <D5K>; CEBB <D5L>; CECA <D5M>; CECB <D5N>		04.06->	<b>0 445 010 343 0 986 437 348</b>
<b>Crafter 35</b>						
2.5 TDI [2E, 2F]	2,5	65/80/ 100/120	BJJ <D5K>; BJK <D5L>; BJL <D5M>; BJM <D5N>; CEBA <D5K>; CEBB <D5L>; CECA <D5M>; CECB <D5N>		04.06->	<b>0 445 010 343 0 986 437 348</b>
<b>Crafter 50</b>						
2.5 TDI [2E, 2F]	2,5	80/100/ 120	BJK <D5L>; BJL <D5M>; BJM <D5N>; CEBB <D5L>; CECA <D5M>; CECB <D5N>		04.06->	<b>0 445 010 343 0 986 437 348</b>
<b>LT</b>						
28 2.8 TDI [2D, 2H]	2,8	116	AUH; BCQ		02.02-04.06	<b>0 445 010 044</b>
35 2.8 TDI [2D, 2H]	2,8	116	AUH; BCQ		02.02-04.06	<b>0 445 010 044</b>
46 2.8 TDI [2D, 2H]	2,8	116	AUH		02.02-04.06	<b>0 445 010 044</b>
<b>Multivan T5</b>						
2.0 TDI, TDI 4 Motion [7E]	2,0	62/75/84/ 100/103/ 132	CAAA <D54>; CAAB <D55>; CAAC <D94>; CAAD <DK3>; CAAE <D94>; CCHA <D91>; CCHB <D94>; CFCA <D49>		09.09->	<b>0 445 010 555</b>
<b>Transporter T5</b>						
2.0 TDI, TDI 4 Motion [7E]	2,0	62/75/84/ 100/103/ 132	CAAA <D54>; CAAB <D55>; CAAC <D94>; CAAD <DK3>; CAAE <D94>; CCHA <D91>; CCHB <D94>; CFCA <D49>		09.09->	<b>0 445 010 555</b>
TDI, TDI 4 Motion [7F]	2,0	62/75/84/ 100/103/ 132	CAAA <D54>; CAAB <D55>; CAAC <D94>; CAAD <DK3>; CAAE <D94>; CCHA <D91>; CCHB <D94>; CFCA <D49>		09.09->	<b>0 445 010 555</b>

**ZIL**

<b>Serie 7t</b>						
5301EE	4,8	100	D 245.9 E3 <Euro 3>		01.08->	<b>0 445 020 088</b>
<b>Serie 14t</b>						
433185	7,1	169	D 260.5 E3 <Euro 3>		05.08->	<b>0 445 020 087</b>
<b>Serie 15t</b>						
4334B1	4,8	115	D 245.30 E3 <Euro 3>		05.08->	<b>0 445 020 088</b>





**MTZ (MINSK TRAKTOR WERK)**

**Belarus**  
1025      4,8    105    D 245 E3 <Euro 3>      01.08→      0 445 020 088



**KAMAZ****Serie 740**

<b>740.60</b> -360	11,8	265	740.72-360 <Euro 4>	08.08→	<b>0 445 020 089</b>
<b>740.61</b> -320	11,8	236	740.71-320 <Euro 4>	08.08→	<b>0 445 020 089</b>
<b>740.62</b> -280	11,8	206	740.70-280 <Euro 4>	08.08→	<b>0 445 020 089</b>
<b>740.63</b> -400	11,8	294	740.73-400 <Euro 4>	08.08→	<b>0 445 020 089</b>
<b>740.64</b> -420	11,8	309	740.74-420 <Euro 4>	08.08→	<b>0 445 020 089</b>
<b>740.65</b> -240	11,8	324	740.75-440 <Euro 4>	08.08→	<b>0 445 020 089</b>

**MMZ (MINSK MOTOREN WERK)****Serie D**

<b>245</b> .30 E3, .35 E3, .7 E3, .9 E3	4,8	90/100/ 115/125	D 245.30 E3 <Euro 3>; D 245.35 E3 <Euro 3>; D 245.7 E3 <Euro 3>; D 245.9 E3 <Euro 3>	01.08→	<b>0 445 020 088</b>
<b>249</b>	4,8	140	D 249 <Euro 3>	10.07→	<b>0 445 020 088</b>
<b>260</b> E3	7,1	169	D 260 E3 <Euro 3>	01.08→	<b>0 445 020 087</b>
<b>262</b> S2	7,9	220,5	D 262 S2 <Euro 3>	10.07→	<b>0 445 020 087</b>
<b>263</b> .1 E3	8,7	257,4	D 263.1 E3 <Euro 3>	10.07→	<b>0 445 020 087</b>

**YAMZ (YAROSLAWL MOTORENWERKE)****Serie 650**

<b>650</b> .10	11,1	303	650.10 <Euro 3>	11.08→	<b>0 445 020 086</b>
<b>6501</b> .10	11,1	266	6501.10 <Euro 3>	11.08→	<b>0 445 020 086</b>
<b>6502</b> .10	11,1	230	6502.10 <Euro 3>	11.08→	<b>0 445 020 086</b>





**ALFA ROMEO**

<b>6</b>						
2.5 D Turbo	2,5	77	VM-HR 588 HT Mot.Nr. 003255→	09.84-02.87	<b>0 460 405 035</b>	
<b>33 Berlina</b>						
1.8 D Turbo [905]	1,8	62	VM 82 A <M9>	09.86-12.89	<b>0 460 403 008</b>	
D Turbo [907]	1,8	62	VM 96 A <M4>	02.90-10.94	<b>0 460 403 013</b>	
<b>33 Sport Wagon</b>						
1.8 D Turbo [905]	1,8	62	VM 82 A <M9>	03.88-12.89	<b>0 460 403 008</b>	
D Turbo [907]	1,8	62	VM 96 A <M4>	01.90-10.94	<b>0 460 403 013</b>	
<b>75</b>						
2.0 TD	2,0	70	VM80A <M5>	05.85-02.92	<b>0 460 494 167</b>	
2.4 TD	2,4	81	VM81A <M6>	09.88-02.92	<b>0 460 404 042</b>	
<b>90</b>						
2.4 D Turbo	2,4	81	VM 81 A	01.85-01.87	<b>0 460 404 042</b>	
<b>145</b>						
1.9 TD [930 MY95]	1,9	66	AR 33601 <M7>	10.94-11.96	<b>0 460 494 390</b>	
			AR 67501 <M6>	04.94-11.96	<b>0 460 494 304</b>	
TD [930 MY97]	1,9	66	AR 33601 <M5>	11.96-05.98	<b>0 460 494 390</b>	
			AR 67501 <M6>	11.96-05.98	<b>0 460 494 389</b>	
<b>146</b>						
1.9 TD [930 MY95]	1,9	66	AR 33601 <U2 M6 CF2>	12.94-11.96	<b>0 460 494 390</b>	
			AR 67501 <U2 M5>	12.94-11.96	<b>0 460 494 304</b>	
TD [930 MY97]	1,9	66	AR 33601 <M5>; AR 67501 <M6>	11.96-05.98	<b>0 460 494 389</b>	
				AGF	<b>0 460 494 390</b>	
<b>155</b>						
1.9 TD [167 MY92]	1,9	66	AR 67501 <U6 M1>	04.93-02.95	<b>0 460 494 304</b>	
				03.95-04.96	<b>0 460 494 389</b>	
TD [167 MY96]	1,9	66	AR 33601 <M1>	05.96-10.97	<b>0 460 494 390</b>	
2.5 TD [167 MY92]	2,5	92	VM07B / VM31B <M2/M3>			
			Mot.Nr. VM 07 B→	04.93-04.96	<b>0 460 404 997</b>	
			Mot.Nr. VM 31 B→	04.93-04.96	<b>0 460 404 991</b>	
TD [167 MY96]	2,5	92	VM31B <M2>	05.96-10.97	<b>0 460 404 991</b>	
<b>164</b>						
2.5 D Turbo [164]	2,5	85	VM84A <M7>	06.87-12.88	<b>0 460 404 050</b>	
				01.89-09.92	<b>0 460 404 065</b>	
		92	VM08B / VM32B <M8/M9>	09.92-12.93	<b>0 460 404 997</b>	
				01.94-10.98 EDC	<b>0 460 404 991</b>	

**AUDI**

<b>A3</b>						
1.9 TDI [8L1]	1,9	66	ALH	08.97-06.01 GS	<b>0 460 404 977</b>	<b>0 986 440 557</b>
		66/81	AGR; AHF	09.96-09.06	<b>0 460 404 977</b>	<b>0 986 440 557</b>
		81	ASV	09.99-06.01	<b>0 460 404 977</b>	<b>0 986 440 557</b>
<b>A4</b>						
1.9 TDI [8D2; B5]	1,9	55	AFF	08.97-06.00	<b>0 460 404 971</b>	<b>0 986 440 555</b>
		66	AHU	08.97-06.00	<b>0 460 404 971</b>	<b>0 986 440 555</b>
			1Z			
			Fg.Nr. →8D-S 250 000	11.94-05.95	<b>0 460 404 994</b>	<b>0 986 440 555</b>
			Fg.Nr. 8D-T 000 001→	05.95-07.96	<b>0 460 404 971</b>	<b>0 986 440 555</b>
TDI, TDI quattro [8D2; B5]	1,9	81	AFN	02.96-07.99	<b>0 460 404 969</b>	<b>0 986 440 554</b>
			AVG	08.99-06.00	<b>0 460 404 969</b>	<b>0 986 440 554</b>
2.5 TDI [8EC; B7]	2,5	120	BDG	11.04-05.06	AG,THI <b>0 470 506 037</b>	<b>0 986 444 084</b>
					GS,THI <b>0 470 506 038</b>	<b>0 986 444 083</b>
TDI [8E2; B6]	2,5	120	BCZ	06.03-12.04	GS,THI <b>0 470 506 033</b>	<b>0 986 444 073</b>
			BDG	06.03-12.04	AG,THI <b>0 470 506 037</b>	<b>0 986 444 084</b>
					GS,THI <b>0 470 506 038</b>	<b>0 986 444 083</b>
TDI quattro [8E2; B6]	2,5	132	AKE; BAU	12.00-12.04	THI <b>0 470 506 033</b>	<b>0 986 444 073</b>
			BDH	11.02-12.04	THI <b>0 470 506 038</b>	<b>0 986 444 083</b>





◀ AUDI

2.5 TDI, TDI quattro [8D2; B5]	2,5	110	AFB	08.97-06.00	VP4	0 470 506 002	0 986 444 067
			AKN	07.98-10.00	AG	0 470 506 010	0 986 444 070
					GS	0 470 506 006	0 986 444 068

**A4 Avant**

1.9 TDI [8D5; B5]	1,9	66	AHU	08.97-06.00		0 460 404 971	0 986 440 555
			1Z				
			Fg.Nr. →8D-S 250 000	01.95-05.95		0 460 404 994	0 986 440 555
			Fg.Nr. 8D-T 000 001→	05.95-07.96		0 460 404 971	0 986 440 555
TDI, TDI quattro [8D5; B5]	1,9	81	AFN	02.96-07.99		0 460 404 969	0 986 440 554
			AVG	08.99-06.00		0 460 404 969	0 986 440 554

2.5 TDI [8ED; B7]	2,5	120	BDG	11.04-05.06	AG,THI	0 470 506 037	0 986 444 084
					GS,THI	0 470 506 038	0 986 444 083
TDI [8E5; B6]	2,5	120	BCZ	06.03-12.04	GS,THI	0 470 506 033	0 986 444 073
			BDG	06.03-12.04	AG,THI	0 470 506 037	0 986 444 084
TDI quattro [8E5; B6]	2,5	132	AKE; BAU	09.01-12.04	THI	0 470 506 033	0 986 444 073
			BDH	11.02-12.04	THI	0 470 506 038	0 986 444 083
TDI, TDI quattro [8D5; B5]	2,5	110	AFB	11.97-06.00	VP4	0 470 506 002	0 986 444 067
			AKN	07.98-09.01	AG	0 470 506 010	0 986 444 070
					GS	0 470 506 006	0 986 444 068

**A4 Cabriolet**

2.5 TDI [8H7; B6]	2,5	120	BCZ	06.03-12.05	GS,THI	0 470 506 033	0 986 444 073
			BDG	06.03-12.05	AG,THI	0 470 506 037	0 986 444 084
					GS,THI	0 470 506 038	0 986 444 083

**A6**

1.9 TDI [4A2; C4]	1,9	66	AHU; 1Z	06.94-10.97		0 460 404 971	0 986 440 555
			TDI [4B2; C5]	1,9	81	AFN; AVG	04.97-10.00
2.5 TDI [4B2; C5]	2,5	120	BDG	11.02-05.04	THI	0 470 506 037	0 986 444 084
TDI, TDI quattro [4A2; C4]	2,5	85/103	AAT; AEL	06.94-10.97		0 460 415 989	0 986 440 563
TDI, TDI quattro [4B2; C5]	2,5	110	AFB	04.97-05.00	VP4	0 470 506 002	0 986 444 067
			AKN	11.98-04.01	AG	0 470 506 010	0 986 444 070
					GS	0 470 506 006	0 986 444 068
		132	AKE	10.99-05.01		0 470 506 016	0 986 444 071
				06.01-08.03	THI	0 470 506 033	0 986 444 073
			BAU	11.02-05.04	THI	0 470 506 033	0 986 444 073
			BDH	11.02-05.04	THI	0 470 506 038	0 986 444 083

**A6 Avant**

1.9 TDI [4A5; C4]	1,9	66	AHU; 1Z	07.94-10.97		0 460 404 971	0 986 440 555
			TDI [4B5; C5]	1,9	81	AFN	02.98-04.01
2.5 TDI [4B5; C5]	2,5	120	BDG	11.02-01.05	THI	0 470 506 037	0 986 444 084
TDI, TDI quattro [4A5; C4]	2,5	85/103	AAT; AEL	06.94-10.97		0 460 415 989	0 986 440 563
TDI, TDI quattro [4B5; C5]	2,5	110	AFB	02.98-05.00	VP4	0 470 506 002	0 986 444 067
			AKN	11.98-04.01	AG	0 470 506 010	0 986 444 070
					GS	0 470 506 006	0 986 444 068
		132	AKE	10.99-05.01		0 470 506 016	0 986 444 071
				06.01-08.03	THI	0 470 506 033	0 986 444 073
			BAU	11.02-01.05	THI	0 470 506 033	0 986 444 073
			BDH	11.02-01.05	THI	0 470 506 038	0 986 444 083

**A6 Avant Allroad**

2.5 TDI [4BH; C5]	2,5	132	AKE	05.00-05.03		0 470 506 016	0 986 444 071
			BAU	06.03-08.05	THI	0 470 506 033	0 986 444 073

**A8**

2.5 TDI, TDI quattro [4D2; D2]	2,5	110	AFB	06.97-06.98	AG,VP4	0 470 506 002	0 986 444 067
					GS	0 470 506 046	0 986 444 074
				Fg.Nr. →4D..W..016 000		07.98-06.00	VP4
			Fg.Nr. 4D..W..016 001→				
		132	AKN	11.97-09.02	AG	0 470 506 010	0 986 444 070
					GS	0 470 506 006	0 986 444 068
			AKE	11.99-09.02		0 470 506 016	0 986 444 071

**Cabriolet**

1.9 TDI [8G7; B4]	1,9	66	AHU; 1Z	07.95-08.00		0 460 404 983	0 986 440 558
-------------------	-----	----	---------	-------------	--	---------------	---------------







<b>80</b>							
1.6 D [81; 85; B2]	1,6	40	JK	Fg.Nr. 81..E..000 001→	07.83-03.87	AG	<b>0 460 484 108</b>
						GS,TW	<b>0 460 494 131</b>
TD [81; 85; B2]	1,6	51	CY		08.81-03.87		<b>0 460 494 063</b>
TD [89; 8A2; B3]	1,6	59	RA		04.88-03.89		<b>0 460 494 237</b>
			SB		04.89-12.91		<b>0 460 494 274</b>
1.9 D [89; 8A2; B3]	1,9	47	1Y		08.89-12.91		<b>0 460 484 029</b>
TD [8C2; B4]	1,9	55	AAZ	Fg.Nr. →8C..P..059 107	09.91-08.92	KL	<b>0 460 494 284</b>
				Fg.Nr. 8C..P..059 108→8C..S..030 000	09.92-08.94	KL	<b>0 460 494 321</b>
						KL	<b>0 460 494 322</b>
				Fg.Nr. 8C..S..030 001→	09.94-05.95	KL	<b>0 460 494 366</b>
						KL	<b>0 460 494 365</b>
TDI [8C2; B4]	1,9	66	1Z	Fg.Nr. →8C..R..058 996	09.91-08.92		<b>0 460 404 998 0 986 440 560</b>
				Fg.Nr. 8C..P..058 997→8C..R..128 400	09.92-01.94		<b>0 460 404 995 0 986 440 559</b>
				Fg.Nr. 8C..R..128 401→	02.94-05.95		<b>0 460 404 983 0 986 440 558</b>
<b>80 Avant</b>							
1.9 TD [8C5; B4]	1,9	55	AAZ	Fg.Nr. →8C..S..030 000	07.93-08.94	KL	<b>0 460 494 321</b>
						KL	<b>0 460 494 322</b>
				Fg.Nr. 8C..S..030 001→	09.94-07.95	KL	<b>0 460 494 366</b>
						KL	<b>0 460 494 365</b>
TDI [8C5; B4]	1,9	66	1Z	Fg.Nr. →8C..R..128 400	08.92-01.94		<b>0 460 404 995 0 986 440 559</b>
				Fg.Nr. 8C..R..128 401→	02.94-07.95		<b>0 460 404 983 0 986 440 558</b>
<b>90</b>							
1.6 TD [89; 8A2; B3]	1,6	59	RA		07.87-07.90		<b>0 460 494 237</b>
			SB		04.89-12.91		<b>0 460 494 274</b>
<b>100</b>							
2.0 D [44; 44Q; C3]	2,0	51	CN		08.80-07.89	AG	<b>0 460 405 032</b>
					08.83-07.89		<b>0 460 405 030</b>
TD [44; 44Q; C3]	2,0	66	DE		08.82-12.87		<b>0 460 405 034</b>
		75	NC		08.87-12.90	CSA	<b>0 460 495 001</b>
2.4 D [4A2; C4]	2,4	60	AAS	Fg.Nr. →4A..P..120 000	05.91-06.93		<b>0 460 485 006</b>
				Fg.Nr. 4A..P..120 001→	07.93-07.94		<b>0 460 485 012</b>
D [44; 44Q; C3]	2,4	60	3D		08.89-12.90		<b>0 460 485 001</b>
2.5 TDI [4A2; C4]	2,5	85	AAT		08.91-07.94	AG	<b>0 460 415 989 0 986 440 563</b>
						GS	<b>0 460 415 998 0 986 440 566</b>
			ABP		06.91-07.92		<b>0 460 415 999</b>
TDI [44; 44Q; C3]	2,5	88	1T		01.90-12.90		<b>0 460 415 999</b>
<b>100 Avant</b>							
2.0 D [44; 44Q; C3]	2,0	51	CN		05.83-07.89	AG	<b>0 460 405 032</b>
TD [44; 44Q; C3]	2,0	66	DE		05.83-12.87		<b>0 460 405 034</b>
		75	NC		03.88-07.88	CSA	<b>0 460 495 001</b>
2.4 D [4A5; C4]	2,4	60	AAS	Fg.Nr. →4A..P..120 000	08.91-06.93		<b>0 460 485 006</b>
				Fg.Nr. 4A..P..120 001→	07.93-07.94		<b>0 460 485 012</b>
D [44; 44Q; C3]	2,4	60	3D		08.89-12.90		<b>0 460 485 001</b>
2.5 TDI [4A5; C4]	2,5	85	AAT		08.91-07.94	AG	<b>0 460 415 989 0 986 440 563</b>
						GS	<b>0 460 415 998 0 986 440 566</b>
			ABP		08.91-07.92		<b>0 460 415 999</b>
TDI [44; 44Q; C3]	2,5	88	1T		01.90-12.90		<b>0 460 415 999</b>





**BMW**

Serie 3							
318 d [E 46]	2,0	85	20 4D 1 <M 47 D 20>		09.01-03.03	0 470 504 025	0 986 444 035
tds [E 36]	1,7	66	17 4T 1 <M 41 D 18>		10.94-03.98	0 460 494 995	0 986 440 538
320 d [E 46]	2,0	100	20 4D 1 <M 47 D 20>		04.98-09.01	AG 0 470 504 020	0 986 444 019
						GS 0 470 504 005	0 986 444 004
324 d [E 30]	2,4	63	24 6D A/B <M 21 D 24>		09.85-12.88	0 460 406 047	
					01.89-12.90	0 460 406 997	0 986 440 518
td [E 30]	2,4	85	24 6T B <M 21 D 24>		09.87-12.90	0 460 406 997	0 986 440 518
325 td [E 36]	2,5	85	25 6T 1 <M 51 D 25>		09.91-01.94	0 460 406 995	0 986 440 517
					02.94-01.95	0 460 406 993	0 986 440 515
					02.95-12.98	0 460 406 994	0 986 440 516
tds [E 36]	2,5	105	25 6T 1 <M 51 D 25>		05.93-12.98	EDC 0 460 406 994	0 986 440 516
Serie 3 Compact							
318 tds [E 36]	1,7	66	17 4T 1 <M 41 D 18>		01.95-09.00	0 460 494 995	0 986 440 538
Serie 3 Touring							
318 d [E 46]	2,0	85	20 4D 1 <M 47 D 20>		03.02-03.03	0 470 504 025	0 986 444 035
tds [E 36]	1,7	66	17 4T 1 <M 41 D 18>		03.95-12.99	0 460 494 995	0 986 440 538
320 d [E 46]	2,0	100	20 4D 1 <M 47 D 20>		10.99-09.01	AG 0 470 504 020	0 986 444 019
						GS 0 470 504 005	0 986 444 004
324 td [E 30]	2,4	85	24 6T B <M 21 D 24>		01.88-12.93	0 460 406 997	0 986 440 518
325 tds [E 36]	2,5	105	25 6T 1 <M 51 D 25>		09.95-12.99	EDC 0 460 406 994	0 986 440 516
Serie 5							
520 d [E 39]	2,0	100	20 4D 1 <M 47 D 20>		04.00-07.03	0 470 504 020	0 986 444 019
524 d [E 28]	2,4	63	24 6D A <M 21 D 24>		03.86-12.87	0 460 406 047	
td [E 28]	2,4	85	24 6T A <M 21 D 24>		09.83-01.87	0 460 406 022	
					01.87-12.87	0 460 406 998	
td [E 34]	2,4	85	24 6T B <M 21 D 24>		03.88-12.91	0 460 406 997	0 986 440 518
525 td, tds [E 34]	2,5	85/105	25 6T 1 <M 51 D 25>		09.91-01.94	0 460 406 995	0 986 440 517
					02.94-01.95	0 460 406 993	0 986 440 515
					02.95-12.95	0 460 406 994	0 986 440 516
td, tds [E 39]	2,5	85/105	25 6T 1 <M 51 D 25>		01.96-09.00	EDC 0 460 406 994	0 986 440 516
Serie 5 Touring							
520 d [E 39]	2,0	100	20 4D 1 <M 47 D 20>		04.00-07.03	0 470 504 020	0 986 444 019
525 td, tds [E 34]	2,5	85/105	25 6T 1 <M 51 D 25>		12.91-01.94	0 460 406 995	0 986 440 517
					02.94-01.95	0 460 406 993	0 986 440 515
					02.95-12.96	0 460 406 994	0 986 440 516
tds [E 39]	2,5	105	25 6T 1 <M 51 D 25>		03.97-09.00	EDC 0 460 406 994	0 986 440 516
Serie 7							
725 tds [E 38]	2,5	105	25 6T 1 <M 51 D 25>		01.96-12.00	0 460 406 994	0 986 440 516

**CHEVROLET**

Blazer							
2.5 D	2,5	74	4A		10.97-01.00	0 460 414 127	

**CHRYSLER**

Cherokee							
2.5 D	2,5	83	VM		01.99-01.04	0 460 404 980	
3.1 D	3,1	110	EXA <VM 3,1 TDI>		01.00-12.01	0 460 405 999	0 986 440 550
Voyager							
2.5 TD [ES]	2,5	85-87	VM HR 425 CLIEE <ENC>		04.92-08.95	0 460 404 073	
					09.95-12.95	0 460 404 988	
TD [GS]	2,5	85	VM HR 425 CLIEE <ENC>		01.95-08.95	0 460 404 073	
					09.95-08.96	0 460 404 988	
					09.96-08.97	CSA 0 460 404 975	
					01.98-12.00	0 460 404 963	



## CITROEN

AX							
1.4 D	1,4	37-39	K9A <TUD3>; K9Y <TUD3Y> Org.Nr. →6244		09.88-02.94	BO	<b>0 460 484 016</b>
Berlingo							
1.9 D [M49]	1,9	50-51	DJY <XUD9> Org.Nr. →7539 Org.Nr. 7540→7664 Org.Nr. 7665→		07.96-11.02 07.96-06.97 07.97-11.97 12.97-11.02	BO,WEG BO,WEG BO,WZT BO,EFV, WZT	<b>0 460 484 070</b> <b>0 460 484 109</b> <b>0 460 484 132</b> <b>0 460 484 137</b>
		52	WJC/WJZ <DW8/W3>		07.98-11.02	BO,WEG BO,WEG	<b>0 460 494 463</b> <b>0 460 494 462</b>
BX							
17 D [X56]	1,8	44	161A <XUD7> Org.Nr. →3978 Org.Nr. 3979→4832 Org.Nr. 4833→		07.85-09.87 10.87-03.90 03.90-03.93	BO BO BO	<b>0 460 484 010</b> <b>0 460 484 014</b> <b>0 460 484 034</b>
D Turbo [X56]	1,8	66	AJZ <XUD7TE/Y> Org.Nr. →5637 ABA <XUD7TE> Org.Nr. →5637		02.88-05.92 03.88-05.92	BO BO	<b>0 460 484 038</b> <b>0 460 484 019</b>
19 D [X56]	1,9	47	DJZ <XUD9Y> 162 <XUD9> Org.Nr. →3613 Org.Nr. 3614→3795 Org.Nr. 3796→3978 Org.Nr. 3979→4161	CH,S CH,S	01.89-12.94 01.89-12.94	AGF,BO AGF,BO	<b>0 460 494 279</b> <b>0 460 494 224</b> <b>0 460 494 153</b> <b>0 460 494 223</b> <b>0 460 494 211</b> <b>0 460 494 222</b>
		51	D9B <XUD9A> Org.Nr. 3614→3795 Org.Nr. 3796→3978 Org.Nr. 3979→4161 Org.Nr. 4162→5653 Org.Nr. 4162→5805 Org.Nr. 5654→		03.87-04.87 03.87-10.87 10.87-04.88 03.88-03.92 03.88-10.92 03.92-12.94	BO BO BO BO AG,BO BO	<b>0 460 494 223</b> <b>0 460 494 211</b> <b>0 460 494 222</b> <b>0 460 494 240</b> <b>0 460 494 240</b> <b>0 460 484 054</b>
C 15							
1.8 D	1,8	44	161A <XUD7> Org.Nr. →3978 Org.Nr. 3979→4890 Org.Nr. 4890→5653 Org.Nr. 5654→		07.86-09.87 10.87-03.90 03.90-04.92 04.92-05.00	BO BO BO BO	<b>0 460 484 010</b> <b>0 460 484 014</b> <b>0 460 484 034</b> <b>0 460 484 056</b>
CX							
25 D Turbo 2	2,5	78	M25-671	A,CH	01.87-12.92	BO	<b>0 460 494 998</b>
Evasion							
1.9 D Turbo [U60]	1,9	66	DHX <XUD9TE> Org.Nr. 7632→7664 Org.Nr. 7665→		10.94-07.02 10.97-11.97 12.97-07.02	N05,WEG N05,WEG EFV,N05, WZT	<b>0 460 494 367</b> <b>0 460 494 427</b> <b>0 460 494 447</b> <b>0 460 494 455</b> <b>0 986 440 161</b>
		67-68	D8B <XUD9TE> Org.Nr. →6968 Org.Nr. 6969→		10.94-07.02 10.94-12.95 01.96-07.02	CSA,N09, WEK N09,OWO N39,OWK N39,WOK N03,WEG N07,WEG EFV,N03, WEG	<b>0 460 494 412</b> <b>0 460 494 370</b> <b>0 460 494 411</b> <b>0 460 494 384</b> <b>0 460 494 341</b> <b>0 460 494 371</b> <b>0 460 494 423</b> <b>0 986 440 156</b>













◀ CITROEN

Jumpy						
1.9 D [U64]	1,9	50-52	D9B <XUD9A>	10.95-01.07	CSA,WEK	<b>0 460 484 098</b>
					OWK	<b>0 460 484 097</b>
					OWO	<b>0 460 484 064 0 986 440 094</b>
					WOK	<b>0 460 484 091</b>
D Turbo [U64]	1,9	66	DHX <XUD9TE>	10.95-01.07	WEG	<b>0 460 494 423 0 986 440 156</b>
					WEG	<b>0 460 494 427</b>
					WZT	<b>0 460 494 455 0 986 440 161</b>
		67-68	D8B <XUD9TF>	10.95-01.07	CSA,N09,	<b>0 460 494 412</b>
					WEK	
					N03,WEG	<b>0 460 494 423 0 986 440 156</b>
					N03,WEG	<b>0 460 494 384</b>
					N09,OWK	<b>0 460 494 411</b>
					N09,OWO	<b>0 460 494 370</b>
					N09,WOK	<b>0 460 494 388</b>
Saxo						
1.5 D [S8]	1,5	40	VJX <TUD5B>	09.00-09.03		<b>0 460 484 148</b>
		40/42	VJY <TUD5Y>; VJZ <TUD5L>	07.96-09.03	BO,OWK	<b>0 460 484 099</b>
					BO,OWO	<b>0 460 484 078</b>
			Org.Nr. →7664	07.96-10.97	BO,CSA,	<b>0 460 484 100</b>
					WEG	
			Org.Nr. 7665→7706	11.97-12.97	BO,WZT	<b>0 460 484 138</b>
			Org.Nr. 7707→	01.98-09.03	BO,WZT	<b>0 460 484 142</b>
Visa						
1.8 D [VD]	1,8	44	161A <XUD7>			
			Org.Nr. →3978	04.84-09.87	BO	<b>0 460 484 010</b>
			Org.Nr. 3979→	10.87-03.90	BO	<b>0 460 484 014</b>
				04.90-03.91	BO	<b>0 460 484 034</b>
Xantia						
1.9 D [X1]	1,9	50-52	DJY/DJZ <XUD9A/Y>	05.94-01.98	AG,BOW	<b>0 460 484 092</b>
					WEG	<b>0 460 484 070</b>
			Org.Nr. →7144	05.94-05.96	WEG	<b>0 460 484 093</b>
			Org.Nr. 6100→	05.94-01.98	AG,BOW	<b>0 460 484 057</b>
			Org.Nr. 7145→	06.96-01.98	WEG	<b>0 460 484 109</b>
			D9B <XUD9A/L>	07.93-01.98	AG,BOW	<b>0 460 484 092</b>
					BOW,GS	<b>0 460 484 091</b>
					BOW,GS	<b>0 460 484 064 0 986 440 094</b>
			Org.Nr. 6100→	07.93-01.98	AG,BOW	<b>0 460 484 057</b>
D Turbo [X1]	1,9	66	DHX, DHY <XUD9BTF/Y, L3>	02.94-01.98	WEG	<b>0 460 494 367</b>
			Org.Nr. →7144	02.94-06.96	WEG	<b>0 460 494 382</b>
			Org.Nr. 7145→	07.96-01.98	WEG	<b>0 460 494 427</b>
		67-68	D8B <XUD9TF/L>	07.93-12.96	WEG	<b>0 460 494 383</b>
			Org.Nr. →6567	07.93-11.94	AGF,WEG	<b>0 460 494 342</b>
			Org.Nr. →6931	07.93-11.95	AGF,WEG	<b>0 460 494 388</b>
			Org.Nr. →6968	07.93-12.95	WEG	<b>0 460 494 341</b>
			Org.Nr. 6568→6931	12.94-11.95	AGF,WEG	<b>0 460 494 370</b>
			Org.Nr. 6932→	12.95-12.96	AGF,CSA,	<b>0 460 494 412</b>
					WEK	
					AGF,WEG	<b>0 460 494 409</b>
					AGF,OWK	<b>0 460 494 411</b>
					AGF,WEG	<b>0 460 494 410</b>
			Org.Nr. 6969→	01.96-12.96	WEG	<b>0 460 494 423 0 986 440 156</b>
D Turbo [X2]	1,9	66	DHX <XUD9BTF/L3>	12.97-12.01	AG	<b>0 460 494 446</b>
					GS	<b>0 460 494 455 0 986 440 161</b>
Xantia Break						
1.9 D Turbo [X1]	1,9	55	DHW <XUD9SD>	04.97-01.98	WEG	<b>0 460 494 367</b>
			Org.Nr. 7145→	04.97-01.98	WEG	<b>0 460 494 427</b>
		66	DHX, DHY <XUD9BTF/L3>	09.95-01.98	WEG	<b>0 460 494 367</b>
			Org.Nr. →7144	09.95-06.96	WEG	<b>0 460 494 382</b>
			Org.Nr. 7145→	07.96-01.98	WEG	<b>0 460 494 427</b>



										
<b>1.9 D Turbo [X1]</b>	1,9	67-68	D8B <XUD9TF/L>	09.95-12.96	WEG	<b>0 460 494 383</b>				
			Org.Nr. →6931	09.95-11.95	AGF,WEG	<b>0 460 494 388</b>				
			Org.Nr. →6968	09.95-12.95	WEG	<b>0 460 494 341</b>				
			Org.Nr. 6568→6931	09.95-11.95	AGF,WEG	<b>0 460 494 370</b>				
			Org.Nr. 6932→	12.95-12.96	AGF,CSA, WEK	<b>0 460 494 412</b>				
					AGF,WEG	<b>0 460 494 409</b>				
					AGF,OWK	<b>0 460 494 411</b>				
		AGF,WEG	<b>0 460 494 410</b>							
		Org.Nr. 6969→	01.96-12.96	WEG	<b>0 460 494 423</b>	<b>0 986 440 156</b>				
<b>D Turbo [X2]</b>	1,9	66	DHX <XUD9BTF/L3>	12.97-12.01	AG	<b>0 460 494 446</b>				
						GS	<b>0 460 494 455</b>	<b>0 986 440 161</b>		
<b>XM</b>										
<b>2.1 D [Y3]</b>	2,1	60-61	P9A <XUD11A>	05.89-03.93	BO	<b>0 460 494 265</b>				
<b>D Turbo [Y3]</b>	2,1	80-81	PHZ <XUD11ATE/L>	05.89-05.92	BO	<b>0 460 494 255</b>				
				Org.Nr. →5669	05.89-06.92	AG,BO	<b>0 460 494 276</b>			
				Org.Nr. →5713	05.92-06.94	BO	<b>0 460 494 310</b>			
				Org.Nr. 5670→	06.92-06.94	AG,BO	<b>0 460 494 313</b>			
				Org.Nr. 5714→	05.89-03.93	BO	<b>0 460 494 264</b>			
				P8A <XUD11ATE>; P8B <XUD11ATE/L>	05.89-06.94	AG,BO	<b>0 460 494 275</b>			
<b>D Turbo [Y4]</b>	2,1	80-81	PHZ <XUD11ATE>	07.94-10.00	AG,WEG	<b>0 460 494 313</b>				
						AG,WEG	<b>0 460 494 386</b>			
						GS,WEG	<b>0 460 494 310</b>			
						AG,WEG	<b>0 460 494 276</b>			
						AG,WEG	<b>0 460 494 385</b>			
		GS,WEG	<b>0 460 494 255</b>							
<b>2.5 D Turbo [Y4]</b>	2,5	94-96	THY <DK5ATE>	07.94-10.00		<b>0 460 404 993</b>	<b>0 986 440 512</b>			
<b>Xsara</b>										
<b>1.9 D [N6]</b>	1,9	50	DJY <XUD9A>	07.97-10.97	BO	<b>0 460 484 132</b>				
				Org.Nr. →7664	11.97-08.00	BO,EFV	<b>0 460 484 137</b>			
				Org.Nr. 7665→	04.98-08.00	BO	<b>0 460 494 467</b>			
				51	WJZ <DW8>	04.98-08.00	BO	<b>0 460 494 467</b>		
<b>D Turbo [N6]</b>	1,9	55	DHV <XUD9BSD>	01.98-08.00		<b>0 460 484 131</b>				
<b>Xsara Break</b>										
<b>1.9 D [N6]</b>	1,9	50	DJY <XUD9A>	04.98-08.00	BO	<b>0 460 484 137</b>				
				51	WJZ <DW8>	04.98-08.00	BO	<b>0 460 494 467</b>		
<b>D Turbo [N6]</b>	1,9	55	DHV <XUD9BSD>	04.98-08.00		<b>0 460 484 131</b>				
<b>Xsara Coupé</b>										
<b>1.9 D [N6]</b>	1,9	50	DJY <XUD9A>	07.97-10.97	BO	<b>0 460 484 132</b>				
				Org.Nr. →7664	11.97-08.00	BO,EFV	<b>0 460 484 137</b>			
				Org.Nr. 7665→	04.98-08.00	BO	<b>0 460 494 467</b>			
				51	WJZ <DW8>	04.98-08.00	BO	<b>0 460 494 467</b>		
<b>D Turbo [N6]</b>	1,9	55	DHV <XUD9BSD>	01.98-08.00		<b>0 460 484 131</b>				
<b>ZX</b>										
<b>1.9 D [N20/N21]</b>	1,9	47-48	DJZ <XUD9Y>	03.91-04.94	AG,BOW	<b>0 460 484 092</b>				
						BOW,GS	<b>0 460 494 279</b>			
				Org.Nr. →6099	03.91-08.93	AG,BOW	<b>0 460 484 055</b>			
				Org.Nr. 6100→	09.93-04.94	AG,BOW	<b>0 460 484 057</b>			
				50	DJY <XUD9Y>	05.94-10.97	BOW,GS	<b>0 460 484 070</b>		
					Org.Nr. →7144	05.94-08.96	BOW,GS	<b>0 460 484 093</b>		
					Org.Nr. 7145→	09.96-10.97	BOW,GS	<b>0 460 484 109</b>		
					Org.Nr. 7301→	12.96-10.97	AG,BOW	<b>0 460 484 110</b>		
				51-52	D9B <XUD9A>	03.91-10.97	AG,BOW	<b>0 460 484 092</b>		
							BOW,GS	<b>0 460 484 091</b>		
					Org.Nr. →5653	03.91-05.92	BOW,GS	<b>0 460 484 047</b>		
					Org.Nr. →6099	03.91-08.93	AG,BOW	<b>0 460 484 055</b>		
					Org.Nr. 5654→	06.92-10.97	BOW,GS	<b>0 460 484 064</b>	<b>0 986 440 094</b>	
	Org.Nr. 6100→	09.93-10.97	AG,BOW	<b>0 460 484 057</b>						
<b>D Turbo [N20/N21]</b>	1,9	66	DHY <XUD9TE/Y>	11.94-10.97	BO,WEG	<b>0 460 494 388</b>				
				Org.Nr. →6566	07.92-11.94	BO,WEG	<b>0 460 494 309</b>			
				Org.Nr. 6567→	12.94-10.97	BO,WEG	<b>0 460 494 344</b>			





◀ CITROEN

1.9 D Turbo [N20/N21]	1,9	68	D8A <XUD9TE>	11.94-10.97	BO,WEG	<b>0 460 494 388</b>
			Org.Nr. →6534	07.92-08.94	BO,WEG	<b>0 460 494 278</b>
			Org.Nr. 6535→6566	09.94-10.94	BO,WEG	<b>0 460 494 342</b>
			Org.Nr. 6567→	11.94-10.97	BO,WEG	<b>0 460 494 370</b>

**DODGE**

<b>Caravan</b>						
2.5 TD [NS]	2,5	85	VM HR 425 CLIEE <ENC>	01.95-08.95		<b>0 460 404 073</b>
				09.95-08.96		<b>0 460 404 988</b>
				09.96-08.97	CSA	<b>0 460 404 975</b>
				09.97-08.03		<b>0 460 404 963</b>

**FIAT**

<b>Brava</b>									
1.9 TD [182..]	1,9	55	182 A 8.000 <M9>; 182 A 8.000 <M20>	03.96-09.01		<b>0 460 484 112</b>			
<b>Bravo</b>									
1.9 TD [182..]	1,9	55	182 A 8.000 <M9>; 182 A 8.000 <M20>	03.96-09.01		<b>0 460 484 112</b>			
<b>Campagnola</b>									
2.5 D	2,5	53	8142.61..	04.84-10.86		<b>0 460 494 109</b>			
<b>Cityvan</b>									
1.7 D [257..]	1,7	44	149 B 3.000 <M3>						
			Mot.Nr. →617390	01.85-08.89		<b>0 460 494 204</b>			
			Mot.Nr. 617391→	01.85-08.89		<b>0 460 484 015</b>			
<b>Croma</b>									
1.9 TD i.d. [154..]	1,9	66	154 B	03.88-04.88		<b>0 460 414 056</b>			
				05.88-06.90		<b>0 460 414 059</b>			
			69	154 C 6.000 <M1>	07.90-10.92		<b>0 460 414 059</b>		
				154 D 1.000 <M2>	11.92-12.96	BOW	<b>0 460 414 125</b>		
						BOW	<b>0 460 414 096</b>		
2.5 D [154..]	2,5	55	8144.67	12.85-12.89		<b>0 460 494 173</b>			
			TD [154..]	74	8144.91.2200	12.85-02.89	<b>0 460 404 040</b>		
				77	8144.97 S <M4>	12.91-11.92	<b>0 460 404 064</b>		
				85	8144.97Y (EM.04) <M5>	11.92-12.96	BOW	<b>0 460 494 419</b>	
							BOW	<b>0 460 494 317</b>	
					8144.97.2200	03.89-06.90		<b>0 460 414 059</b>	
					86	8144.97 <M3>	07.90-10.92		<b>0 460 404 059</b>
			TDI [154..]	2,5	85	8144.97Y (US87) <M5>	09.93-11.96		<b>0 460 494 996</b>
<b>Duna</b>									
1.7 D [155..]	1,7	44	149 B 3.000						
			Mot.Nr. →617390	10.86-12.90		<b>0 460 494 204</b>			
			Mot.Nr. 617391→	10.86-12.90		<b>0 460 484 015</b>			
<b>Duna Weekend</b>									
1.7 D [155..]	1,7	44	149 B 3.000						
			Mot.Nr. →617390	10.86-12.90		<b>0 460 494 204</b>			
			Mot.Nr. 617391→	10.86-12.90		<b>0 460 484 015</b>			
<b>Fiorino</b>									
1.3 D [127..]	1,3	33	127 A 5.000	04.82-12.87		<b>0 460 484 006</b>			
D [255..]	1,3	33	127 A 5.000 <M4>	01.88-08.93		<b>0 460 484 023</b>			
1.7 D [255..]	1,7	42	149 B 4.046 <M7>	01.88-08.93		<b>0 460 494 235</b>			
			43	146 B 2.000 <M6>	09.93-12.01	BOW	<b>0 460 484 095</b>		
						BOW	<b>0 460 484 051</b>		
				Mot.Nr. 0674374→1040480	01.88-08.93		<b>0 460 484 015</b>		
				Mot.Nr. 1040481→	01.88-08.93	BOW	<b>0 460 484 051</b>		
				149 B 3.000 <M5>					
		Mot.Nr. →617390	01.88-12.90		<b>0 460 494 204</b>				
		Mot.Nr. 617391→	01.88-12.90		<b>0 460 484 015</b>				
<b>Fiorino Furgao</b>									
1.7 D	1,7	52	146 B 2.000	01.04-12.08		<b>0 460 484 051</b>			





<b>Marea</b>						
1.9 TD [185..]	1,9	55,1	182 A 8.000 <M2>		10.96-09.02	<b>0 460 484 112</b>
2.4 TD [185..]	2,4	91	185 A 2.000 <M3>		10.96-02.99	<b>0 460 495 998</b>
<b>Marengo</b>						
1.9 D [259..]	1,9	48	160 A 7.000 <M1>			
			Mot.Nr. →1060717		02.90-12.96 BO	<b>0 460 484 024</b>
			Mot.Nr. 1060718 →1360563		02.90-12.96 BO	<b>0 460 484 052</b>
D Turbo [259..]	1,9	66	160 A 6.000 <M2>		02.90-12.96 BOW	<b>0 460 494 389</b>
			Mot.Nr. →10329777		02.90-11.91	<b>0 460 494 250</b>
			Mot.Nr. 1032978 →		12.91-12.96 BOW	<b>0 460 494 304</b>
TD [285..]	1,9	55/55,1	182 A 8.000 <M2>		01.97-09.02	<b>0 460 484 112</b>
2000 D [138..]	2,0	48	149 A 1..		01.86-07.89	<b>0 460 494 132</b>
<b>Palio</b>						
1.7 D, TD	1,7	52	M 708 N7 17 L; 176A3000		02.97-08.01 BOW	<b>0 460 484 084</b>
					WEG	<b>0 460 484 126</b>
D Turbo [Fase II]	1,7	52			01.04-12.07	<b>0 460 484 083</b>
<b>Palio SW</b>						
1.7 T	1,7	53	M 708 H7 17 D		09.97-08.01	<b>0 460 484 155</b>
<b>Palio Weekend</b>						
1.7 D Turbo [Fase II]	1,7	52			10.04-12.08	<b>0 460 484 083</b>
TD [178..]	1,7	46/51	176 B 7.000 <M41>; 178 C 9.066 <M40>		08.00-02.02 BOW	<b>0 460 484 113</b>
					BOW	<b>0 460 484 154</b>
		51	176 A 3.000 <M3>		09.97-10.00 BOW	<b>0 460 484 083</b>
<b>Panda</b>						
1.3 D [141..]	1,3	27	156 A 5.000		07.90-08.92	<b>0 460 484 012</b>
1300 D [141..]	1,3	27	156 A 5.000		03.86-12.89	<b>0 460 484 012</b>
<b>Punto</b>						
1.7 TD [176]	1,7	46	176 B 7.000 <M3>		05.97-08.99 BOW	<b>0 460 484 113</b>
		51	176 A 3.000 <M2>		08.93-04.97 BOW,CSA	<b>0 460 484 067</b>
					08.93-08.99 BOW	<b>0 460 484 083</b>
		51-53	176 A 5.000 <M1>		08.93-04.97 BOW	<b>0 460 484 084</b>
					BOW	<b>0 460 484 068</b>
<b>Punto VAN</b>						
1.7 TD [276]	1,7	51	176 A 3.000 <M2>		05.97-08.99 BOW	<b>0 460 484 083</b>
		53	176 A 5.000 <M1>		05.97-08.99 BOW	<b>0 460 484 084</b>
TD SOFT [276]	1,7	46	176 B 7.000 <M3>		05.97-08.99 BOW	<b>0 460 484 113</b>
<b>Regata</b>						
1.7 D [138..]	1,7	44	149 B 3.000		05.85-03.89	<b>0 460 494 170</b>
1.9 D Super [138..]	1,9	48	149 A 1..		04.84-07.89	<b>0 460 494 132</b>
D Turbo [138..]	1,9	59	831 D 1..		05.86-07.89	<b>0 460 494 187</b>
					AGF	<b>0 460 494 236</b>
					KL	<b>0 460 494 163</b>
<b>Ritmo</b>						
1.7 D [138A..]	1,7	44	149 B 3..		05.85-08.86 AGF	<b>0 460 494 196</b>
					05.85-12.87	<b>0 460 494 170</b>
					09.86-12.87 AGF	<b>0 460 494 204</b>
1.9 D Turbo [138A..]	1,9	59	831 D 1..		12.85-12.87	<b>0 460 494 163</b>
<b>Scudo</b>						
1.9 D [222..]	1,9	51	D9B <M2>		10.95-05.00 CSA,WEK	<b>0 460 484 098</b>
					OWK	<b>0 460 484 097</b>
					OWO	<b>0 460 484 064 0 986 440 094</b>
					WOK	<b>0 460 484 091</b>
TD [222..]	1,9	66	DHX <M4>		03.97-05.97 WEG	<b>0 460 494 427</b>
			Ricam.Nr →7665		06.97-11.97 WZT	<b>0 460 494 447</b>
			Ricam.Nr 7666 →		12.97-05.00 WZT	<b>0 460 494 455 0 986 440 161</b>
			Ricam.Nr 7848 →		06.98-05.00 WEG	<b>0 460 494 423 0 986 440 156</b>
		68	D8B <M3>		10.95-05.00 CSA,LWG,	<b>0 460 494 412</b>
					WEK	
					KOB,WEG	<b>0 460 494 423 0 986 440 156</b>
					KOB,WEG	<b>0 460 494 384</b>
					LWG,OWK	<b>0 460 494 411</b>
					LWG,OWO	<b>0 460 494 370</b>
					LWG,WOK	<b>0 460 494 388</b>





◀ FIAT

**Strada**

1.7 D Turbo	1,7	52		07.99-12.04	<b>0 460 484 083</b>
D Turbo [Fase II]	1,7	52		01.05-12.08	<b>0 460 484 083</b>
TDS [278]	1,7	51	176 A 3.000 <M10>	03.99-03.03 BOW	<b>0 460 484 083</b>

**Tempra**

1.9 D [159]	1,9	48	160 A 7.000 <M1>		
			Mot.Nr. →1060717	02.90-03.93 BO	<b>0 460 484 024</b>
			Mot.Nr. →1360563	04.93-12.96 BO	<b>0 460 484 052</b>
			Mot.Nr. 1060718→1360563	02.90-03.93 BO	<b>0 460 484 052</b>
TD [159]	1,9	60	160 B 6.046 <M3>	07.90-03.93	<b>0 460 494 272</b>
		66	160 A 6.000 <M2>	04.93-12.96 BOW	<b>0 460 494 389</b>
			Mot.Nr. →10329777	02.90-11.91	<b>0 460 494 250</b>
			Mot.Nr. 1032978→	12.91-12.96 BOW	<b>0 460 494 304</b>
			160 D 1.000 <M3>	04.93-12.96 BOW	<b>0 460 494 339</b>
			Mot.Nr. →1743413	04.93-12.96 BOW	<b>0 460 414 125</b>
			Mot.Nr. 1743414→	04.93-12.96 BOW	<b>0 460 494 390</b>
		68	160 A 6.046 <M4>	07.90-03.93 BO	<b>0 460 494 246</b>

**Tempra SW**

1.9 D [159]	1,9	48	160 A 7.000 <M1>		
			Mot.Nr. →1060717	12.90-03.93 BO	<b>0 460 484 024</b>
			Mot.Nr. →1360563	04.93-12.96 BO	<b>0 460 484 052</b>
			Mot.Nr. 1060718→1360563	12.90-03.93 BO	<b>0 460 484 052</b>
TD [159]	1,9	60	160 B 6.046 <M3>	07.90-03.93	<b>0 460 494 272</b>
		66	160 A 6.000 <M2>	04.93-12.96 BOW	<b>0 460 494 389</b>
			Mot.Nr. →10329777	02.90-11.91	<b>0 460 494 250</b>
			Mot.Nr. 1032978→	12.91-12.96 BOW	<b>0 460 494 304</b>
			160 D 1.000 <M3>	04.93-12.96 BOW	<b>0 460 494 339</b>
			Mot.Nr. →1743413	04.93-12.96 BOW	<b>0 460 414 125</b>
			Mot.Nr. 1743414→	04.93-12.96 BOW	<b>0 460 494 390</b>
		68	160 A 6.046 <M4>	07.90-03.93 BO	<b>0 460 494 246</b>

**Tipo**

1.7 D [160..]	1,7	42	149 B 4.000 <M1>	07.91-03.93 BO	<b>0 460 484 051</b>
			Mot.Nr. →538535	07.87-03.89 BO	<b>0 460 494 204</b>
			Mot.Nr. 538536→	04.89-06.91 BO	<b>0 460 484 015</b>
1.9 D [160..]	1,9	48	160 A 7.000 <M2>		
			Mot.Nr. →1060717	07.89-06.91	<b>0 460 484 024</b>
			Mot.Nr. 1060717→	03.93-10.95	<b>0 460 484 052</b>
			Mot.Nr. 1060718→	07.91-03.93	<b>0 460 484 052</b>
D Turbo [160..]	1,9	65	160 D 1.000 <M4>	03.93-10.95	<b>0 460 494 339</b>
		68	160 A 6.000 <M3>	03.93-10.95	<b>0 460 494 304</b>
TD [160..]	1,9	59	160 B 6.046 <M4>		
			Mot.Nr. →0773741	06.90-03.93 BO	<b>0 460 494 225</b>
			Mot.Nr. 0773742→	06.90-03.93 BO	<b>0 460 494 272</b>
		67,6	160 A 6.046 <M5>		
			Mot.Nr. →0773741	06.90-03.93 BO	<b>0 460 494 225</b>
			Mot.Nr. 0773742→	06.90-03.92 BO	<b>0 460 494 246</b>
			Ricam.Nr 4325795		
			Ricam.Nr 4325796→	04.92-03.93 BO	<b>0 460 494 272</b>
		68	160 A 6.000 <M3>		
			Mot.Nr. →0773741	07.87-03.93 BO	<b>0 460 494 225</b>
			Mot.Nr. 0773742→1035403	12.89-03.93 BO	<b>0 460 494 250</b>
			Mot.Nr. 1035404→	12.89-03.93 BO	<b>0 460 494 304</b>

**Ulysse**

1.9 TD [121..]	1,9	66	DHX <M4>		
			Ricam.Nr VET.6970→	01.96-05.98	<b>0 460 494 423 0 986 440 156</b>
			Ricam.Nr →VET.6969	01.95-12.95	<b>0 460 494 371</b>
			DHX <M7>	10.96-12.99 WEG	<b>0 460 494 367</b>
			Ricam.Nr →7510	10.96-06.97 WEG	<b>0 460 494 427</b>
			Ricam.Nr 7511→7665	07.97-11.97 WZT	<b>0 460 494 447</b>
			Ricam.Nr 7666→	12.97-12.99 WZT	<b>0 460 494 455 0 986 440 161</b>







1.9 TD [121..]	1,9	66	D8B <M3>		01.95-05.98	CSA,WEK	0 460 494 412	
						OWK	0 460 494 411	
						WOK	0 460 494 384	
					Ricam.Nr →6969	01.95-12.95	OWO	0 460 494 370
			Ricam.Nr 6970→	01.96-05.98	OWO	0 460 494 423	0 986 440 156	

**Uno**

1.3 D	1,3	33	146B000		05.91-12.94		0 460 484 023	
D [146..]	1,3	33	127 A 5.000		06.83-08.89		0 460 484 006	
			146 B 1.000 <M1>		09.89-03.92	BO	0 460 484 023	

1.4 D Turbo [146..]	1,4	52	146 B 3.000 <M2>					
				Mot.Nr. →1049014	09.89-09.92	BO	0 460 484 028	
				Mot.Nr. 1049015→	09.89-09.92	BO	0 460 484 053	
TD [146..]	1,4	52	146 B 3.000		03.86-08.89		0 460 494 193	

1.7 D [146..]	1,7	42	146 B 2.000 <M3>						
				Mot.Nr. →1042804	09.89-03.94	BO	0 460 484 015		
				Mot.Nr. 10428805→	09.89-03.94	BO	0 460 484 051		
				44	149 B 3.000	07.86-03.89		0 460 494 204	
						10.87-08.89	AGF	0 460 494 235	
		04.89-08.89		0 460 484 015					

1.9 D [146..]	1,9	44	149 B 5.046 <M4>		09.89-03.94	BO	0 460 494 253	
---------------	-----	----	------------------	--	-------------	----	---------------	--

**Uno Van**

1.7 D [246..]	1,7	42	146 B 2.000 <M3>					
				Mot.Nr. →1042804	01.91-03.94	BO	0 460 484 015	
				Mot.Nr. 10428805→	01.91-03.94	BO	0 460 484 051	

**127**

1300 D, D Panorama	1,3	33	127 A..		06.83-12.86		0 460 484 006	
--------------------	-----	----	---------	--	-------------	--	---------------	--

**147**

1.3 CLD Spazio	1,3	33	146B000		02.84-08.89		0 460 484 006	
					09.89-11.97		0 460 484 023	

**FISSORE**

**Magnum**

2.4 D Turbo 4x4	2,4	77	Sofim 8144.81..		07.84-04.86		0 460 404 041	
-----------------	-----	----	-----------------	--	-------------	--	---------------	--

**Rayton**

2.4 D Turbo 4x4	2,4	82	HR 492 HIM		03.88-12.01		0 460 404 042	
-----------------	-----	----	------------	--	-------------	--	---------------	--

**FORD**

**Courier**

1.8 D	1,8	44	DKK <Endura-DE>		01.97-04.99		0 460 484 143	0 986 440 107
					05.99→		0 460 484 150	0 986 440 225

**Escort**

1.8 D	1,8	44	RTF; RTH <Endura-DE>		01.95-11.01	BO,E93	0 460 484 079	
-------	-----	----	----------------------	--	-------------	--------	---------------	--

**Escort IV**

1.6 D [86]	1,6	40	LTC <D16>		01.86-12.88	AGR,BO, CSA	0 460 494 122	
				CH	04.88-12.88	AGR,BO	0 460 494 233	
				CH	01.86-12.88	AGR,BO	0 460 494 186	

1.8 D [86]	1,8	44	RTA <IDI>; RTB <IDI>		01.89-07.90		0 460 494 216	
						AGF	0 460 494 218	
				CH	06.90-07.90	AGF	0 460 494 257	

**Escort IV Express**

1.6 D [86]	1,6	40	LTC <D16>		01.86-12.88	AGR,BO, CSA	0 460 494 122	
				CH	04.88-12.88	AGR,BO	0 460 494 233	
				CH	01.86-12.88	AGR,BO	0 460 494 186	

1.8 D [86]	1,8	44	RT... <D18>		01.89-07.90		0 460 494 216	
						AGF	0 460 494 218	
				CH	06.90-07.90	AGF	0 460 494 257	





◀ FORD

Escort IV Turnier							
1.6 D [86]	1,6	40	LTC <D16>	01.86-12.88	AGR, BO, CSA		<b>0 460 494 122</b>
				CH 04.88-12.88	AGR, BO		<b>0 460 494 233</b>
				CH 01.86-12.88	AGR, BO		<b>0 460 494 186</b>
Escort VII							
1.8 D [86]	1,8	44	RT... <IDI>	01.89-07.90			<b>0 460 494 216</b>
					AGF		<b>0 460 494 218</b>
				CH 06.90-07.90	AGF		<b>0 460 494 257</b>
Escort VII Express							
1.8 D 55, D 75 [95]	1,8	44	RTF <D18NA>; RTH <D18NA>	01.95-09.01	BO, E93		<b>0 460 484 079</b>
					BO, N07		<b>0 460 494 374</b>
Escort VII Turnier							
1.8 D [95]	1,8	44	RTF <D18NA>; RTH <D18NA>	01.95-09.01	BO, E93		<b>0 460 484 079</b>
					BO, N07		<b>0 460 494 374</b>
Escort V/VI							
1.8 D [91]	1,8	44	RT... <D18NA>	08.90-11.93	BO, N07		<b>0 460 494 218</b>
				08.90-12.94	BO, N01		<b>0 460 494 216</b>
				12.93-08.94	BO, E93		<b>0 460 484 063</b>
				12.93-12.94	BO, N07		<b>0 460 494 374</b>
				09.94-12.94	BO, E93		<b>0 460 484 079</b>
Escort V/VI Express							
1.8 D [91]	1,8	44	RTH <D18NA>	08.90-11.93	BO, N07		<b>0 460 494 218</b>
				08.90-12.94	BO, N01		<b>0 460 494 216</b>
				12.93-08.94	BO, E93		<b>0 460 484 063</b>
				12.93-12.94	BO, N07		<b>0 460 494 374</b>
				09.94-12.94	BO, E93		<b>0 460 484 079</b>
Escort V/VI Turnier							
1.8 D [91]	1,8	44	RTH <D18NA>	08.90-11.93	BO, N07		<b>0 460 494 218</b>
				08.90-12.94	BO, N01		<b>0 460 494 216</b>
				12.93-08.94	BO, E93		<b>0 460 484 063</b>
				12.93-12.94	BO, N07		<b>0 460 494 374</b>
				09.94-12.94	BO, E93		<b>0 460 484 079</b>
Fiesta							
1.8 D	1,8	44	RTC; RTD <Endura-DE>	01.98-04.99			<b>0 460 484 143</b>
				05.99-08.03			<b>0 460 484 150</b>
							<b>0 986 440 107</b>
							<b>0 986 440 225</b>
Fiesta II							
1.6 D [84]	1,6	40	LTB <XLD>	10.85-02.89	AGR		<b>0 460 494 186</b>
					AGR, CSA		<b>0 460 494 122</b>
Fiesta III							
1.8 D [89]	1,8	44	RT... <DSL>	03.89-11.93	BO, N01		<b>0 460 494 216</b>
					BO, N07		<b>0 460 494 218</b>
				12.93-08.94	BO, E93		<b>0 460 484 063</b>
				12.93-12.96	BO, N07		<b>0 460 494 374</b>
				09.94-12.96	BO, E93		<b>0 460 484 079</b>
				10.95-12.96	BO, E93,		<b>0 460 484 096</b>
					LH		
					E96, WEG		<b>0 460 484 144</b>
Fiesta III Courier							
1.8 D [89]	1,8	44	RT... <D18NA>	09.91-11.93	BO, N01		<b>0 460 494 216</b>
					BO, N07		<b>0 460 494 218</b>
				09.91-08.96	AGF, BO		<b>0 460 494 218</b>
				12.93-08.94	BO, E93		<b>0 460 484 063</b>
				12.93-08.96	BO, N07		<b>0 460 494 374</b>
				09.94-08.96	BO, E93		<b>0 460 484 079</b>
				10.95-08.96	BO, E93,		<b>0 460 484 096</b>
					LH		
					E96, WEG		<b>0 460 484 144</b>





<b>Fiesta IV</b>							
1.8 D [96]	1,8	44	RT... <D18, Endura-DE>	10.95-08.96	BO,E93, WW	0 460 484 096	
				10.95-04.99	BO,E96, WEG	0 460 484 144	
					BO,E96, WEG	0 460 484 143	0 986 440 107
				10.95-06.01	BO,E93	0 460 484 079	
					BO,N07	0 460 494 374	
				05.99-06.01	BO,E96, WEG	0 460 484 152	0 986 440 226
					BO,E96, WEG	0 460 484 150	0 986 440 225
TD [96]	1,8	55	RT... <LD18, Endura-DI>	02.00-12.02	EE2	0 470 004 008	0 986 444 521
					E96,FD3	0 470 004 007	0 986 444 519
<b>Fiesta IV Courier</b>							
1.8 D [96]	1,8	44	RT... <D18, Endura-DE>	10.95-08.96	BO,E93, WW	0 460 484 096	
				10.95-04.99	BO,E96, WEG	0 460 484 144	
					BO,E96, WEG	0 460 484 143	0 986 440 107
				10.95-06.01	BO,E93	0 460 484 079	
					BO,N07	0 460 494 374	
				05.99-06.01	BO,E96, WEG	0 460 484 152	0 986 440 226
					BO,E96, WEG	0 460 484 150	0 986 440 225
TD [96]	1,8	55	RT... <LD18, Endura-DI>	02.00-12.02	EE2	0 470 004 008	0 986 444 521
					E96,FD3	0 470 004 007	0 986 444 519
<b>Focus I</b>							
1.8 TDDi [99]	1,8	55/66	BHD... <LD18,Endura-DI>; BHDA <LD18,Endura-DI>; BHDB <LD18,Endura-DI>; C9D... <LD18,Endura-DI>; C9DA <LD18,Endura-DI>; C9DC <LD18,Endura-DI>	01.99-07.00		0 470 004 007	0 986 444 519
				08.00-05.05		0 470 004 008	0 986 444 521
<b>Focus I Turnier</b>							
1.8 TDDi [99]	1,8	55/66	BHDA <LD18,Endura-DI>; BHDB <LD18,Endura-DI>; C9DA <LD18,Endura-DI>; C9DB <LD18,Endura-DI>; C9DC <LD18,Endura-DI>	01.99-07.00		0 470 004 007	0 986 444 519
				08.00-05.05		0 470 004 008	0 986 444 521
<b>Focus Sedan</b>							
1.8 D Turbo	1,8	66	C9DC	09.00→		0 470 004 007	0 986 444 519
<b>Galaxy</b>							
1.9 TDI [95]	1,9	66/81	AHU <D19N (VW 19N)>; AVG <D19P (VW 19P)>; 1Z <D19N (VW 19N)>	02.95-03.00		0 460 404 971	0 986 440 555
		81	AFN <D19P (VW 19P)>	11.97-03.00		0 460 404 968	0 986 440 567
<b>Granada III</b>							
2.5 D Turbo [92]	2,5	68	SF... <PD25T>	02.92-09.94		0 460 404 075	
<b>Granada III Estate</b>							
2.5 D Turbo [92]	2,5	68	SF... <PD25T>	02.92-09.94		0 460 404 075	
<b>Maverick</b>							
2.7 TD [UDS, UNS]	2,7	74	TD27	06.93-04.96		9 460 610 619	
<b>Mondeo III</b>							
2.0 TDDi [01]	2,0	66	D5BA <Duratorq-DI>	10.00-03.07		0 470 004 013	0 986 444 520
		85	D6BA <Duratorq-DI>	10.00-07.02		0 470 504 024	0 986 444 079
				08.02-08.02		0 470 504 036	0 986 444 075
<b>Mondeo III Turnier</b>							
2.0 TDDi [01]	2,0	66	D5BA <Duratorq-DI>	10.00-03.07		0 470 004 013	0 986 444 520
		85	D6BA <Duratorq-DI>	10.00-07.02		0 470 504 024	0 986 444 079
				08.02-08.02		0 470 504 036	0 986 444 075
<b>Orion II</b>							
1.6 D [86]	1,6	40	LTC <D16>	04.86-01.89	AGR,BO, CSA	0 460 494 122	
				CH 04.88-01.89	AGR,BO	0 460 494 233	
				GH 04.86-01.89	AGR,BO	0 460 494 186	





◀ FORD

<b>1.8 D [86]</b>	1,8	44	RT... <IDI>	01.89-07.90		<b>0 460 494 216</b>
					AGF	<b>0 460 494 218</b>
				CH 06.90-07.90	AGF	<b>0 460 494 257</b>
<b>Orion III</b>						
<b>1.8 D [91]</b>	1,8	44	RT... <IDI>	07.90-11.93	BO,N07	<b>0 460 494 218</b>
				07.90-12.93	BO,N01	<b>0 460 494 216</b>
				12.93-12.93	BO,N07	<b>0 460 494 374</b>
TD [91]	1,8	66	RF... <D18T>	12.93-12.93	BO,E93	<b>0 460 484 063</b>
<b>Ranger</b>						
<b>2.5 D, D 4x4 [99]</b>	2,5	57	WL <MD25NA>	01.99-10.07	TW	<b>9 460 613 382</b>
						<b>9 460 613 519</b>
						<b>9 460 613 526</b>
						<b>9 460 613 527</b>
TD, TD 4x4 [99]	2,5	62/80	WL-T <MD25TI(HP)>; WL-T <MD25TI(NP)>	01.99-10.07	TW	<b>9 460 613 525</b>
<b>Scorpio I</b>						
<b>2.5 TD [92]</b>	2,5	85	SCB <VM25T>	08.93-09.94		<b>0 460 404 075</b>
<b>Scorpio I Turnier</b>						
<b>2.5 TD [92]</b>	2,5	85	SCB <VM25T>	08.93-09.94		<b>0 460 404 075</b>
<b>Scorpio II</b>						
<b>2.5 TD [95]</b>	2,5	85	SCC <VM25-TCI>	10.94-03.96		<b>0 460 404 075</b>
				04.96-12.98		<b>0 460 404 981</b>
		92	SCD <VM25-TCI>	04.96-12.98		<b>0 460 404 981</b>
<b>Scorpio II Turnier</b>						
<b>2.5 TD [95]</b>	2,5	85	SCC <VM25-TCI>	10.94-03.96		<b>0 460 404 075</b>
				04.96-12.98		<b>0 460 404 981</b>
		92	SCD <VM25-TCI>	01.97-12.98		<b>0 460 404 981</b>
<b>Tourneo Connect</b>						
<b>1.8 TDDi [02]</b>	1,8	55	BHPA <Euro3>; BHPB <93EEC>	05.02-06.10		<b>0 470 004 008 0 986 444 521</b>

**HONDA**

<b>Accord Hatchback</b>						
<b>2.0 TDi [CG/CH/CL]</b>	2,0	77	20T2N	01.99-10.00		<b>0 460 414 992 0 986 440 522</b>
<b>Accord Sedan</b>						
<b>2.0 D Turbo [CE/CF]</b>	2,0	77	20T2N	09.95-10.98	EDC	<b>0 460 414 992 0 986 440 522</b>
TDi [CG/CH/CL]	2,0	77	20T2N	01.99-02.03		<b>0 460 414 992 0 986 440 522</b>
<b>Civic Aerodeck</b>						
<b>2.0 D Turbo [MB/MC]</b>	2,0	77	20T2N	04.98-02.01		<b>0 460 414 992 0 986 440 522</b>

**INNOCENTI (NUOVA INNOCENTI)**

<b>Elba</b>						
<b>1.7 D</b>	1,7	42	146 B 2.000	09.92-12.96		<b>0 460 484 015</b>
			146 B 2.000 <M5>	09.92-12.96		<b>0 460 484 051</b>

**ISUZU**

<b>Gemini</b>						
<b>1.5 D</b>	1,5	37/40	4EC1	01.88-12.93		<b>9 460 610 330</b>
<b>Pick-Up</b>						
<b>2.0 D [KB]</b>	2,0	34	C190	01.83-12.93		<b>9 460 610 015</b>
				04.86-12.93		<b>9 460 610 104</b>
<b>2.2 D [KB]</b>	2,2	39	C223	04.86-12.90	TW	<b>9 460 610 122</b>
					WW	<b>9 460 610 123</b>
			Fg.Nr. C*6206726→	08.86-12.90	TW	<b>9 460 610 116</b>
						<b>9 460 612 356</b>
						<b>9 460 614 696</b>



l/ccm



kW/(PS)



Typ



<b>Trooper</b>					
2.2 D [UBS]	2,2	53	C223	02.81-10.88	9 460 610 274
					9 460 610 332
					DRE, KL 9 460 610 106
					KL, MDR 9 460 610 016
					HL, KL, 9 460 610 109
					MDR
					HL, KL, 9 460 610 110
					MDR
					HL, KL, 9 460 610 111
					MDR
					HL, KL, TW 9 460 610 112
					KL, MDR 9 460 610 107
					KL, MDR 9 460 610 108
					TW 9 460 610 131
				10.83-10.88	9 460 610 179
				01.84-10.88	KL, MDR, 9 460 610 114
					WW
					KL, MDR 9 460 610 115
					KL, MDR, 9 460 610 116
					WW
					KL, MDR, 9 460 610 117
					WW
				01.88-10.88	9 460 610 099
D Turbo [UBS]	2,2	84	C223T	03.84-10.88	DRE, KL 9 460 610 127
					DRE, KL 9 460 610 102
					KL, MDR 9 460 610 100
					KL, MDR 9 460 610 101
					TW 9 460 610 131
				03.85-10.88	TW 9 460 610 259
2.8 D Turbo [UBS]	2,8	71	4JB1T	10.87-12.91	9 460 610 287
					9 460 610 315
					DRE 9 460 610 316
				10.88-12.91	9 460 610 367
					9 460 610 375
D Turbo Interc. [UBS]	2,8	78	4JB1TC	10.88-02.90	9 460 610 360
				03.90-12.91	9 460 610 453

**JEEP**

<b>Cherokee</b>					
2.1 D Turbo [XJ]	2,1	64/65	Renault J8S-814	04.84-08.95	0 460 494 160
		65	Renault J8S-890	09.91-08.95	0 460 494 315
2.5 D Turbo [XJ]	2,5	85-89	ENC, ENO <VM HR 425 CLIRX>	10.95-12.01	0 460 404 078
<b>Comanche</b>					
2.1 D Turbo [MJ]	2,1	64	J8S-814	01.88-09.88	0 460 494 160
<b>Wagoneer</b>					
2.1 D Turbo [SJ]	2,1	64	J8S-814	01.88-12.94	0 460 494 160

**KIA**

<b>Carnival</b>					
2.9 D Turbo	2,9	92	JR TCI	03.00-03.03	0 460 414 178
D Turbo [UP]	2,9	93	J3	06.98-09.01	AG 0 460 414 193
					GS 0 460 414 191
<b>Sedona</b>					
2.9 D Turbo [UP]	2,9	93	J3	06.98-09.01	AG 0 460 414 193
					GS 0 460 414 191





**LADA**

Niva					
1.5 TD	1,5	48	3411	09.94-12.99	<b>0 460 484 147</b>
1.8 TD	1,8	55	3431	07.99-12.00	<b>0 460 484 147</b>
Serie 2100					
2104 1.5 TD	1,5	48	341	01.97-12.00	<b>0 460 484 147</b>

**LANCIA**

Dedra Berlina					
1.9 TD [835]	1,9	66	835A4.000 <M1>	01.89-10.94	<b>0 460 494 250</b>
			835A4.000/160D1.000 <M1/M2>	10.94-10.99	EU2,WEG <b>0 460 494 339</b>
					EU2,WEG <b>0 460 494 390</b>
					EU2,WEG <b>0 460 494 304</b>
					EU2,WEG <b>0 460 494 389</b>

Dedra Station Wagon					
1.9 TD [835]	1,9	66	835A4.000/160D1.000 <M1/M2>	10.94-10.99	EU2,WEG <b>0 460 494 339</b>
					EU2,WEG <b>0 460 494 390</b>
					EU2,WEG <b>0 460 494 304</b>
					EU2,WEG <b>0 460 494 389</b>

Delta					
1.9 TD [831]	1,9	59	831D1.000 <M8>	06.86-06.91	<b>0 460 494 163</b>
TD [836]	1,9	66	160D1.000 <SQ M2>	A,D 10.95-08.98	WEG <b>0 460 494 390</b>
				A,D 10.95-12.99	<b>0 460 494 339</b>
			835A4.000 <SQ M1>	07.94-10.95	WEG <b>0 460 494 389</b>
				A,D 07.94-10.95	<b>0 460 494 304</b>

Kappa Berlina					
2.4 TD [838]	2,4	91	838A3.000 <M1>; 838A7.000 <M2>	11.94-03.98	<b>0 460 495 998</b>

Kappa Station Wagon					
2.4 D Turbo [838]	2,4	91	838A7.000 <M2>	06.96-03.98	<b>0 460 495 998</b>

Prisma					
1.9 D	1,9	48	831 D..	06.84-07.88	<b>0 460 494 144</b>
				08.88-12.89	<b>0 460 494 238</b>
D Turbo	1,9	59	831 D..	05.85-12.89	<b>0 460 494 163</b>
				03.86-12.89	AGF <b>0 460 494 236</b>

Thema Berlina					
2.5 TD [104]	2,5	74	8144.91.2200	A 03.88-09.88	<b>0 460 404 060</b>
				A 11.84-09.88	<b>0 460 404 040</b>
		85	8144.97S.2200 <M9>	06.88-05.92	<b>0 460 494 996</b>
			8144.97Y	05.92-11.94	<b>0 460 494 317</b>
				01.93-11.94	<b>0 460 494 997</b>
			8144.97.2200 <M8>	06.88-05.92	<b>0 460 404 059</b>

Thema Station Wagon					
2.5 TD [104]	2,5	74	8144.91.2200	A 03.88-09.88	<b>0 460 404 060</b>
				A 11.84-09.88	<b>0 460 404 040</b>
		85	8144.97S.2200 <M9>	06.88-05.92	<b>0 460 494 996</b>
			8144.97Y	05.92-11.94	<b>0 460 494 317</b>
			8144.97Y EDC-Bosch	01.93-11.94	<b>0 460 494 996</b>
			8144.97.2200 <SZ M8>	06.88-05.92	<b>0 460 404 059</b>

**LAND ROVER GROUP**

Defender 90					
2.5 D Turbo	2,5	80-83	Gemini TCI D.I. 23L <200/300 Tdi>		
			Mot.Nr. →23L 03832 A	09.94-12.01	AGR,WEG <b>0 460 414 099</b>
			Mot.Nr. 11 L...→	08.90-12.01	<b>0 460 414 080</b>
			Mot.Nr. 16L...→	09.94-12.01	AGR <b>0 460 414 098</b> <b>0 986 440 038</b>
			Mot.Nr. 23 L 03833 A→	09.94-12.01	AGR,WEG <b>0 460 414 136</b>



Defender 110						
2.5 D Turbo	2,5	80-83	Gemini TCI D.I. 23L <200/300 Tdi>			
			Mot.Nr. →23L 03832 A	09.94-12.01	AGR,WEG	0 460 414 099
			Mot.Nr. 11 L ...→	08.90-12.01		0 460 414 080
			Mot.Nr. 16L ...→	09.94-12.01	AGR	0 460 414 098 0 986 440 038
			Mot.Nr. 23 L 03833 A→	09.94-12.01	AGR,WEG	0 460 414 136
		85	Maxion HS4TCC <Euro I>	08.98-12.05	TW	0 460 414 194
						0 460 414 205

Defender 130						
2.5 D Turbo	2,5	80-83	Gemini TCI D.I. 23L <200/300 Tdi>			
			Mot.Nr. →23L 03832 A	09.94-12.01	AGR,WEG	0 460 414 099
			Mot.Nr. 11 L ...→	08.90-12.01		0 460 414 080
			Mot.Nr. 16L ...→	09.94-12.01	AGR	0 460 414 098 0 986 440 038
			Mot.Nr. 23 L 03833 A→	09.94-12.01	AGR,WEG	0 460 414 136
		85	Maxion HS4TCC <Euro II>	02.00-12.05		0 460 414 205

Discovery I						
2.5 TDi	2,5	82-83	200 Tdi	A	09.89-09.94	0 460 414 093
		82-90	19L 21L 22L 300 Gemi		10.93-12.98	AGF 0 460 414 098 0 986 440 038
			Fg.Nr. VA 703237→VA 534104→		10.93-12.98	AGR 0 460 414 136
						AGR 0 460 414 991
			Fg.Nr. →TA 703236 →TA 534103		10.93-12.98	AGR 0 460 414 099
						AGR 0 460 414 997

Freelander						
2.0 D [LN]	2,0	70-72	20T <L-Serie>		09.97-09.03	0 460 404 973 0 986 440 507

Land Rover 110						
2.5 D Turbo	2,5	79	200 Tdi <DI TCI Gemini>; 300 Tdi <DI TCI Gemini>		07.89-07.90	TW 0 460 414 069
						0 460 414 080

Range Rover I						
2.4 D Turbo	2,4	78-89	VM-81A		04.86-12.90	0 460 404 042
2.5 D Turbo	2,5	89	VM-HR-492.4		09.90-09.94	0 460 404 070
TDi Classic	2,5	83	14L <200 Tdi>		10.92-09.95	0 460 414 997
				A	10.92-09.95	0 460 414 093

Range Rover II						
2.5 D	2,5	100-102	25 6T		09.94-08.02	0 460 406 994 0 986 440 516
TDi	2,5	81-83	14L <300 Tdi>		10.94-04.96	AGF 0 460 414 098 0 986 440 038
						AGR 0 460 414 099
						EDC 0 460 414 997

MAHINDRA

Bolero						
2.5 D	2,5	53	XD 3P IDI		05.00-04.05	BS1 0 460 494 479
D, D XLS	2,5	46	MDI 3200TC		05.05→	TW 0 460 414 251
						0 460 414 254
D XL	2,5	43	MDI 3200D		01.04-03.05	BS1 0 460 414 197
						BS2 0 460 414 231
D XLS	2,5	44,5	XD 3PH		01.04-12.05	BS1 0 460 494 479
D 4WD	2,5	46	MDI 3200 TC		05.05→	TW 0 460 414 251
						0 460 414 254
		53	XD 3P IDI		05.00-04.05	0 460 494 479
Bolero Invader						
2.5 D	2,5	40	MDI 3200		06.03-10.04	0 460 414 197
D, D 4WD	2,5	46	MDI 3200 TC		12.04→	TW 0 460 414 251
						0 460 414 254
D GLX	2,5	53	XD 3P IDI		06.03-10.04	0 460 494 479
Classic						
2.1 D 4WD	2,1	46	XDP 4.90		05.96-10.02	0 460 494 434
MM 540/550						
DP 2.1 D 4WD	2,1	46	XDP 4.90C		04.96→	0 460 494 434
XDB 2.5 D, D 4WD	2,5	53	XD 3P		11.91-05.97	9 460 034 409
MM 775 XDB						
2.5 D	2,5	53	XD 3PB		05.91→	9 460 034 409





◀ MAHINDRA

Scorpio						
2.6 D Turbo	2,6	80	SZ2600 plus	06.02-01.03	BS2	0 460 414 223
				06.02-03.06	BS1	0 460 414 221
				02.03-03.06	BS2	0 460 414 228
D Turbo 4WD [MI]	2,6	80	SZ2600 plus	06.02-01.03	BS2	0 460 414 223
				06.02-03.06	BS1	0 460 414 221
				02.03-03.06	BS2	0 460 414 228

**MAZDA**

MPV							
2.5 12V D Turbo [LV]	2,5	85	WLT		03.96-05.99	9 460 614 272	
Serie B							
2500 D, D 4x4 [UN]	2,5	57	MD25NA		02.99-03.06	9 460 613 527	
				TR	02.99-03.06	9 460 613 519	
D Turbo, D Turbo 4x4 [UN]	2,5	62	WLE7		09.01-03.06	<del>EU3</del> 9 460 614 809	
				Fg.Nr. →322592	09.01-03.06	EU3	9 460 614 206
D Turbo 4x4 [UN]	2,5	80	WLT		02.99-03.06	EU3	9 460 613 941
						<del>EU3</del>	9 460 613 522
				Fg.Nr. 322593→	02.99-03.06	EU3	9 460 614 206
						<del>EU3</del>	9 460 614 208
12VD [UF]	2,5	63	WL		03.96-05.99	9 460 613 266	
12VD 4x4 [UF]	2,5	57-63	WL		03.96-05.99	9 460 613 266	

323								
1.7 D [BF]	1,7	40-44	PN27		04.85-11.87	9 460 610 223		
				Fg.Nr. →349499	04.85-11.87	9 460 610 262		
				Fg.Nr. 349500→400000	04.87-05.89	9 460 610 245		
				Fg.Nr. 400001→409282	04.87-05.89	9 460 610 263		
				Fg.Nr. 409283→	05.98-10.00	9 460 613 193		
2.0 D [BJ]	2,0	52	RF		05.98-10.00	9 460 613 193		
323 Hatchback								
1.7 D [BG]	1,7	41	PN46		06.89-03.91	9 460 610 448		
		43	PN62		04.91-02.96	9 460 610 499		
2.0 D [BJ]	2,0	52	RF		06.98-09.99	9 460 613 193		
323 Sedan								
1.7 D [BG]	1,7	41	PN46		06.89-03.91	9 460 610 448		
		43	PN62		03.91-05.94	9 460 610 499		
323 Wagon								
1.7 D [BW]	1,7	40-44	PN27		04.86-06.87	9 460 610 262		
				Fg.Nr. BW12117976→	04.86-06.87	9 460 610 223		
				Fg.Nr. →BW12117976	07.87-04.90	9 460 610 263		
				41	PN26		07.87-04.90	9 460 610 263
					PN54		09.89-06.95	9 460 610 428
				Fg.Nr. →503670	09.89-06.95	9 460 610 448		
				Fg.Nr. 503670→507988	09.89-06.95	9 460 610 549		
				Fg.Nr. 507988→520435	09.89-06.95	9 460 610 601		
Fg.Nr. 520435→528904	09.89-06.95	9 460 610 601						
Fg.Nr. 528904→	09.89-06.95	9 460 610 716						

626						
2.0 D [GC]	2,0	53	RF46		07.85-06.87	9 460 610 193
				D [GD]	2,0	44
D Complex [GE]	2,0	55	RF		12.88-07.91	9 460 610 311
				Fg.Nr. →115899	03.92-05.94	9 460 610 585
				Fg.Nr. 115900→	06.94-12.95	9 460 611 767
				Fg.Nr. GE***426631→	12.95-03.97	9 460 611 062
				Fg.Nr. GE***465703→	06.94-12.95	9 460 614 031
Fg.Nr. →GE***426631						







626 Hatchback						
2.0 D Comprex [GE]	2,0	55	RF		03.92-05.94	9 460 610 585
				Fg.Nr. GE***426631→	06.94-12.95	9 460 611 767
				Fg.Nr. GE***465703→	12.95-03.97	9 460 611 062
				Fg.Nr. →GE***426631	06.94-12.95	9 460 614 031
626 Wagon						
2.0 D [GV]	2,0	44	RF		03.88-03.92	9 460 610 311
		55	RFH7		03.92-10.97	9 460 610 547
D Comprex [GV]	2,0	60	RFH5		03.92-10.97	9 460 610 548
			RF83		03.88-10.89	9 460 610 309

**MERCEDES-BENZ**

Serie E						
290 D Turbo [210]	2,9	95	OM 602.982 <DE LA>		01.96-05.99 EDC	0 460 415 991 0 986 440 530
Serie E (T-Modell)						
290 D Turbo [210]	2,9	95	OM 602.982 <DE LA>		05.96-05.99 EDC	0 460 415 991 0 986 440 530

**MG**

ZR						
2.0 D Turbo	2,0	74/82	20 T2N <L-Serie>		10.01-05.05	0 470 004 005 0 986 444 503
ZS						
2.0 TD	2,0	74	20 T2N <L-Serie>		10.01-05.05	0 470 004 005 0 986 444 503

**MITSUBISHI**

Colt						
1.8 D [C1]	1,8	44	4D65		11.83-05.86	9 460 610 078
					06.86-06.88	9 460 610 225
Galant						
1.8 D Turbo [E1]	1,8	60-63	4D65		05.84-05.86	AG, GLX 9 460 610 197
						GLA 9 460 610 079
						GLX, GS 9 460 610 080
					06.86-11.87	AG 9 460 610 228
						GLA, GS 9 460 610 226
						GLX, GS 9 460 610 227
L 200						
2.5 D, D 4WD [K6/K7]	2,5	64	4D56		01.96-06.01	LLE 9 460 614 549
						RLE 9 460 614 157
D Turbo Interc. 2WD [K6/K7]	2,5	74-85	4D56		01.96-12.07	AG 9 460 613 999
						GS 9 460 613 955
D Turbo Interc. 4WD [K6/K7]	2,5	73-85	4D56		01.96-03.98	ABS, GS, 9 460 610 915
						WEG
						ABS, GS, 9 460 610 961
						WEG
						AG, WEG 9 460 613 177
						AG, WEG 9 460 610 962
						ABS, GS, 9 460 610 913
						WEG
						ABS, GS, 9 460 610 960
						WEG
					04.98-06.01	AG, WEG 9 460 613 232
						AG, WEG 9 460 614 544
						GS, WEG 9 460 614 187
						GS, WEG 9 460 613 234
					07.01-12.07	AG 9 460 613 999
						GS 9 460 613 955





◀ MITSUBISHI

2.5 D Turbo 4WD [K0-K3]	2,5	73	4D56	11.92-10.93	9 460 610 623				
				11.93-05.94	9 460 610 663				
				06.94-03.01	9 460 610 671				
D 2WD [K0-K3]	2,5	54	4D56	10.84-10.93 LH	9 460 610 591				
				11.88-05.94 LH	9 460 610 625				
				11.93-05.94 LH	9 460 610 876				
				06.94-05.96 LH	9 460 610 908				
				LH	9 460 610 909				
D 2WD [K6/K7]	2,5	55-64	4D56	06.95-03.98 ABS,FKR, WEG	9 460 611 605				
				ABS,FKR, WEG	9 460 612 412				
				06.95-06.01 ABS	9 460 610 959				
				FLR,LLE	9 460 614 549				
				FLR,RLE	9 460 614 157				
				04.98-06.01 FKR,WEG	9 460 614 104				
D 4WD [K0-K3]	2,5	54	4D56	A 11.89-10.92	9 460 610 374				
				A 12.87-10.92	9 460 610 625				
2.8 D [K6/K7]	2,8	92	4M40	06.95→	9 460 614 393				
<b>L 200 Forte</b>									
2.5 D Turbo Interc. [K7]	2,5	73-85	4D56	01.97-03.98 ABS,GS, WEG	9 460 610 915				
				ABS,GS, WEG	9 460 610 961				
				AG,WEG	9 460 613 177				
				AG,WEG	9 460 610 962				
				ABS,GS, WEG	9 460 610 913				
				ABS,GS, WEG	9 460 610 960				
				01.97→ RLE	9 460 614 158				
				04.98→ AG,WEG	9 460 613 232				
				AG,WEG	9 460 614 544				
				GS,WEG	9 460 614 187				
GS,WEG	9 460 613 234								
<b>L 300</b>									
2.3 D Wagon [L]	2,3	49-50	4D55	06.84-10.86	9 460 610 168				
<b>L 300 Wagon</b>									
2.5 D Turbo 4WD [P]	2,5	62-64	4D56	12.87-10.89	9 460 610 522				
				11.89-12.91	9 460 610 582				
				01.92-05.96	9 460 610 583				
				D 2WD long [P]	2,5	51	4D56	11.86-12.91	9 460 610 580
				01.92-06.95	9 460 610 579				
				07.95-12.00	9 460 610 683				
				D 2WD short [P]	2,5	51	4D56	11.86-10.89	9 460 610 398
				11.89-10.90	9 460 610 580				
				11.90-12.91	9 460 610 528				
				01.92-08.97	9 460 610 581				
<b>L 400</b>									
2.5 D Turbo 2WD, D Turbo 4WD	2,5	64	4D56	12.94-03.01 AGF	9 460 610 687				
				AGF	9 460 610 685				
<b>Lancer</b>									
1.8 D [C1/C3]	1,8	43	4D65	11.83-05.86	9 460 610 078				
				06.86-06.88	9 460 610 225				
<b>Lancer Station Wagon</b>									
1.8 D [C1/C3]	1,8	45	4D65	07.85-05.86	9 460 610 078				
				06.86-05.88	9 460 610 225				
<b>Pajero</b>									
2.3 TD [L]	2,3	62	4D55	09.84-04.86	9 460 610 004				





2.5 TD [L]	2,5	62	4D56			05.86-10.88	AG	9 460 610 372
							GS	9 460 610 361
						11.88-10.89	AG	9 460 610 559
							GS	9 460 610 406
TD [V]	2,5	62	4D56			11.89-06.91		9 460 610 559
						04.91-07.93		9 460 614 315
						08.93-05.95		9 460 610 954
TD Interc. [L]	2,5	70	4D56			06.95-05.99		9 460 614 177
						05.86-10.88	AG	9 460 610 372
							GS	9 460 610 361
TD Interc. [V]	2,5	73-77	4D56			11.88-10.89	AG	9 460 610 559
							GS	9 460 610 406
						11.89-06.91	AG	9 460 610 465
							GS	9 460 610 442
TD Interc. [V60; V70]	2,5	85	4D56			CH 12.90-06.00		9 460 610 546
						GH 12.90-05.92	AGF	9 460 610 493
						12.90-10.93	ABS	9 460 610 523
							ABS	9 460 610 529
						06.92-05.97	AGF	9 460 610 643
						11.93-05.97	ABS	9 460 610 642
							ABS	9 460 610 640
						06.97-02.98	WEG	9 460 612 419
							WEG	9 460 612 420
						03.98-06.00	EU2,WEG	9 460 614 187
	EU2,WEG	9 460 613 234						
		EU3	9 460 613 955					
2.8 D [V]	2,8	92	4M40			02.00-06.01		9 460 613 234
						07.01-08.06		9 460 613 981
TD Interc. [V]	2,8	103	4M40			06.94-05.99		9 460 614 156
						11.93-04.00	ABS,FMA	9 460 610 647
							ABS,KL	9 460 614 513
		ABS,KL	9 460 614 111					
3.2 DI-D [V]	3,2	121				05.00→		F 019 Z1D 003
DI-D 4WD [V60; V70]	3,2	118-121	4M41			02.00-11.00		F 019 Z1D 003
<b>Pajero Cabrio</b>								
2.5 D [V]	2,5	62	4D56			08.93-05.95		9 460 610 954
						06.95-05.99		9 460 614 177
TD Interc. [V]	2,5	73-77	4D56			CH 12.90-05.01		9 460 610 546
						GH 12.90-10.93		9 460 610 529
						11.93-05.94	ABS	9 460 610 640
						06.94-09.95		9 460 610 724
						10.95-05.96	WEG	9 460 610 724
							WEG	9 460 610 926
						06.96-02.98	WEG	9 460 611 612
							WEG	9 460 611 565
						03.98-05.01	WEG	9 460 614 187
							WEG	9 460 613 234
<b>Pajero Sport</b>								
2.5 TD [K]	2,5	73-85	4D56			08.98-06.01		9 460 613 234
						07.01-02.09		9 460 613 955
TD+ [K]	2,5	98	4D56			07.01-02.09		9 460 613 955





◀ MITSUBISHI

Space Gear								
2.5 D Turbo Interc. 2WD	2,5	73	4D56	12.94-05.96	AGF	9 460 610 688		
					AGF,KZO,	9 460 610 686		
					WEG			
					AGF,KZO,	9 460 610 689		
					WEG			
					AGF,KZO	9 460 610 924		
					06.96-02.98	ABS,WEG	9 460 614 530	
						ABS,WEG	9 460 614 531	
						ABS,WEG	9 460 612 415	
						ABS,WEG	9 460 613 499	
03.98-03.01	WEG	9 460 614 546						
	WEG	9 460 614 161						
D Turbo Interc. 4WD	2,5	73	4D56	12.94-05.96	AGF	9 460 610 688		
					AGF,KZO,	9 460 610 686		
					WEG			
					AGF,KZO,	9 460 610 689		
					WEG			
					AGF,KZO	9 460 610 924		
					06.96-02.98	ABS,WEG	9 460 614 530	
						ABS,WEG	9 460 614 531	
						ABS,WEG	9 460 612 415	
						ABS,WEG	9 460 613 499	
03.98-03.01	WEG	9 460 614 546						
	WEG	9 460 614 161						
D Turbo 2WD long	2,5	64	4D56	06.94-05.95	9 460 614 518			
D Turbo 2WD short	2,5	64	4D56	12.94-05.96	AGF	9 460 610 688		
					AGF,KZO,	9 460 610 686		
					WEG			
					AGF,KZO,	9 460 610 689		
					WEG			
					AGF,KZO	9 460 610 924		
					06.96-02.98	ABS,WEG	9 460 614 530	
						ABS,WEG	9 460 614 531	
						ABS,WEG	9 460 612 415	
						ABS,WEG	9 460 613 499	
03.98-03.01	WEG	9 460 614 546						
	WEG	9 460 614 161						

Space Wagon							
1.8 D Turbo [D]	1,8	55	4D65	06.85-05.87	9 460 610 219		
				06.87-04.91	9 460 610 322		

**NISSAN**

Almera Hatchback							
2.0 D [N15]	2,0	55	CD20	04.96-04.00	EDC	9 460 611 579	
				FIN,IS,	07.95-04.96	9 460 610 682	
				N,S			
2.2 D Turbo [N16E]	2,2	81	YD22DDT	07.95-04.96		9 460 610 705	
				FIN,IS,			
				N,S			
2.2 D Turbo [N16E]	2,2	81	YD22DDT	01.00-03.01		0 470 504 012	0 986 444 013
				⊕	04.01-02.03	0 470 504 028	0 986 444 057
Almera Sedan							
2.0 D [N15]	2,0	55	CD20	04.96-04.00	EDC	9 460 611 579	
				FIN,IS,	07.95-04.96	9 460 610 682	
				N,S			
2.2 D Turbo [N16E]	2,2	81	YD22DDT	07.95-04.96		9 460 610 705	
				FIN,IS,			
				N,S			
2.2 D Turbo [N16E]	2,2	81	YD22DDT	04.00-03.01		0 470 504 012	0 986 444 013
				⊕	03.01-02.03	0 470 504 028	0 986 444 057
Almera Tino							
2.2 D Turbo [V10M]	2,2	81-84	YD22DDTI	05.00-03.01		0 470 504 012	0 986 444 013
				⊕	04.01-01.03	0 470 504 028	0 986 444 057



Bluebird Hatchback						
2.0 D [T12]	2,0	47-49	LD20		12.85-02.88	9 460 610 438
					03.88-02.90	9 460 610 338
D [T72]	2,0	49	LD20		09.88-04.90	9 460 610 338
Bluebird Kombi						
2.0 D [U11]	2,0	43	LD20		11.83-01.86	9 460 610 405
		49	LD20		02.86-05.90	9 460 610 438
					11.85-04.90	9 460 610 438
D Turbo [U11]	2,0	55	LD20T		11.83-01.86	9 460 610 176
Bluebird Sedan						
2.0 D [T12]	2,0	47-49	LD20		12.85-02.88	9 460 610 438
					03.88-02.90	9 460 610 338
D [T72]	2,0	49	LD20		09.88-04.90	9 460 610 338
D [U11]	2,0	43	LD20		11.83-01.86	9 460 610 405
		49	LD20		11.85-04.90	9 460 610 438
D Turbo [U11]	2,0	55	LD20T		11.83-01.86	9 460 610 176
Cherry Hatchback						
1.7 D [N12]	1,7	40	CD17		06.84-05.86	AG 9 460 610 065
						GS 9 460 610 068
						GS,WW 9 460 610 064
Gloria						
2.8 D [430]	2,8	67	LD28		08.80-06.87	HL 9 460 610 177
					12.81-06.87	NOR 9 460 610 085
Laurel						
2.8 D [C32]	2,8	62-67	LD28		01.85-02.87	9 460 610 232
						AG 9 460 610 497
		70	RD28		02.87-10.90	9 460 610 313
						AG 9 460 610 266
Patrol						
2.8 D [260]	2,8	80	RD28		04.89-05.98	9 460 610 573
D Turbo [260]	2,8	85	RD28T		06.89-05.98	9 460 610 574
						AGF 9 460 610 600
Patrol GR						
2.8 D Turbo [Y60]	2,8	85	RD28T		10.94-08.95	9 460 611 162
					08.95-09.97	9 460 611 325
				CH,D	09.88-09.97	9 460 610 488
				CH,D	09.88-09.97	9 460 610 423
D Turbo, D Turbo 4x4 [Y61]	2,8	95-96	RD28TI		10.97→	9 460 611 586
3.0 Di Hardtop 4x4, Di 4x4 [Y61]	3,0	116	ZD30DDTI		02.00-07.04	9 443 615 728
				D	08.04-03.10	0 470 504 046
Pickup						
2.3 D [D21]	2,3	51	SD23		S 09.85-08.87	9 460 610 141
					S 09.85-08.87	9 460 610 220
2.5 D, D 4WD [D21]	2,5	53	SD25		S 09.85-08.87	9 460 610 142
					S 09.85-08.87	9 460 610 140
		59-63	TD25		08.87-02.98	9 460 610 314
D, D 4WD [D22]	2,5	61	TD25		02.98-11.01	WEG 9 460 613 482
						WEG 9 460 611 649
D Turbo 4WD [D22]	2,5	76	TD25TI		05.98-11.01	WEG 9 460 614 027
D 4WD [D21]	2,5	55	TD25		08.87-02.92	9 460 610 444
2.7 D 2WD [D21]	2,7	62	TD27		08.87-11.90	9 460 610 325
					11.90-03.92	9 460 610 536
					03.92-10.95	9 460 610 325
D 2WD [D22]	2,7	64	TD27		02.97→	TW 9 460 611 352
						9 460 611 960
D 4WD [D21]	2,7	62	TD27		08.87-11.90	9 460 610 325
					11.90-03.92	9 460 610 536
					03.92-10.95	9 460 610 325





◀ NISSAN

Primera Hatchback						
2.0 D [P10E]	2,0	55	CD20	01.91-11.91		9 460 610 478
					AGF	9 460 610 468
					SLX	9 460 610 479
				01.91-05.93	AG	9 460 610 551
					AG,SLX	9 460 610 552
				12.91-08.92	AGF	9 460 610 531
				12.91-05.93		9 460 610 554
					SLX	9 460 610 550
				09.92-09.94	AGF	9 460 610 553
				06.93-09.94	AGF,SLX	9 460 610 550
				10.94-06.96	AGF	9 460 610 703
					AGF,SLX	9 460 610 705
					AGF,TW	9 460 610 682
D Turbo [P11E]	2,0	66	CD20T	06.96-10.97		9 460 611 579
				11.97-12.01		0 460 404 965
Primera Sedan						
2.0 D [P10E]	2,0	55	CD20	01.91-11.91		9 460 610 478
					AGF	9 460 610 468
					SLX	9 460 610 479
				01.91-05.93	AG	9 460 610 551
					AG,SLX	9 460 610 552
				12.91-08.92	AGF	9 460 610 531
				12.91-05.93		9 460 610 554
					SLX	9 460 610 550
				09.92-09.94	AGF	9 460 610 553
				06.93-09.94	AGF,SLX	9 460 610 550
				10.94-06.96	AGF	9 460 610 703
					AGF,SLX	9 460 610 705
					AGF,TW	9 460 610 682
D Turbo [P11E]	2,0	66	CD20T	06.96-10.97		9 460 611 579
				11.97-12.01		0 460 404 965
Primera Wagon						
2.0 D [W10]	2,0	55	CD20	07.90-01.92	SLX	9 460 610 479
				07.90-02.94		9 460 610 554
				02.92-02.94	SLX	9 460 610 550
				04.93-02.94	AGF	9 460 610 553
				03.94-01.95		9 460 610 703
					AGF	9 460 610 682
					SLX	9 460 610 705
				02.95-04.96		9 460 610 704
					SLX	9 460 610 706
				A 07.90-01.92		9 460 610 480
				02.92-08.92		9 460 610 531
D Turbo [WP11E]	2,0	66	CD20T	01.98-12.01		0 460 404 965
Pulsar Hatchback						
1.7 D [N13]	1,7	41	CD17	06.86-08.90		9 460 610 333
					AG	9 460 610 258
					TW	9 460 610 257
						9 460 610 334
Serena						
2.0 D [C23M]	2,0	49	LD20	07.92-05.93	AGF	9 460 610 568
					AGF	9 460 610 569
				06.93-09.94	AGF	9 460 610 635
					AGF	9 460 610 684





2.3 D [C23M]	2,3	55	LD23	09.94-10.95	0 460 494 403
				11.95-06.96	AGF,WEG 0 460 494 403
					AGF,TW 0 460 494 355
				11.95-03.98	AGF,WEG 0 460 494 404
				07.96-03.98	TW,WEG 0 460 494 355
				04.98-07.99	AGF,WEG 0 460 494 461
					AGF,TW 0 460 494 465
					AGF,WEG 0 460 494 469
	AGF,TW 0 460 494 468				
		08.99-11.01		0 460 494 461	

**Sunny**

2.0 D	2,0	56	CD20	01.94→	9 460 610 557
-------	-----	----	------	--------	---------------

**Sunny Hatchback**

1.7 D [N13]	1,7	40	CD17	06.86-08.90	9 460 610 333
					AG 9 460 610 258
					TW 9 460 610 257
				WW 9 460 610 334	

2.0 D [N14]	2,0	55	CD20	10.90-08.91	9 460 610 468
					9 460 610 478
					SLX 9 460 610 479
				09.91-10.92	9 460 610 531
					9 460 610 554
					SLX 9 460 610 550
				10.92-05.95	9 460 610 703
					GS,SLX 9 460 610 705
				11.92-05.95	GS,SLX 9 460 610 705
				DK,FIN, IS,N,S	11.92-05.95
DK,FIN, IS,N,S	11.92-05.95	9 460 610 703			

**Sunny Sedan**

1.7 D [B11]	1,7	40	CD17	03.84-05.88	9 460 610 066
					AG 9 460 610 067
		45	CD17	03.84-05.88	9 460 610 485
				AG 9 460 610 486	
D [B12]	1,7	40	CD17	01.86-04.90	9 460 610 334
D [N13]	1,7	40	CD17	06.86-08.90	9 460 610 333
					AG 9 460 610 258
					TW 9 460 610 257
				WW 9 460 610 334	

2.0 D [N14]	2,0	55	CD20	10.90-08.91	9 460 610 468
					9 460 610 478
					SLX 9 460 610 479
				09.91-10.92	9 460 610 531
					9 460 610 554
					SLX 9 460 610 550
				10.92-05.95	9 460 610 703
					GS,SLX 9 460 610 705
				11.92-05.95	GS,SLX 9 460 610 705
				DK,FIN, IS,N,S	11.92-05.95
DK,FIN, IS,N,S	11.92-05.95	9 460 610 703			

**Sunny Wagon**

1.7 D [B11]	1,7	40	CD17	03.84-05.88	9 460 610 066
					AG 9 460 610 067
		45	CD17	03.84-05.88	9 460 610 485
				AG 9 460 610 486	
D [B12]	1,7	40	CD17	01.86-06.88	9 460 610 334
				06.88-09.90	AGF 9 460 610 627





◀ NISSAN

1.7 D [Y10]	1,7	40	CD17 <VA>	05.92-04.98		<b>9 460 610 597</b>			
				BG,PL,RO	05.92-04.98	<b>9 460 610 593</b>			
				BG,PL,RO	05.92-04.98	<b>9 460 610 597</b>			
2.0 D [Y10]	2,0	55	CD20 <VC>	11.90-10.92		<b>9 460 610 478</b>			
				11.90-03.00		<b>9 460 610 553</b>			
					SLX	<b>9 460 610 550</b>			
				10.92-03.94		<b>9 460 610 554</b>			
<b>Terrano I</b>									
2.7 D [WD21]	2,7	62	TD27	08.87-11.90	HL	<b>9 460 610 326</b>			
					KZO	<b>9 460 610 327</b>			
					NOR	<b>9 460 610 325</b>			
				12.90-11.95	HL	<b>9 460 610 538</b>			
					KZO	<b>9 460 610 727</b>			
D Turbo [WD21]	2,7	73	TD27T	02.89-09.92		<b>9 460 610 519</b>			
				10.92-10.93		<b>9 460 610 561</b>			
<b>Terrano II</b>									
2.7 D Turbo 4x4 [R20]	2,7	74	TD27T	02.93-09.93	GRF	<b>9 460 610 619</b>			
					GRF,WW	<b>9 460 610 702</b>			
					02.93-05.96	TW	<b>9 460 610 791</b>		
				09.93-05.96	GRF,TW	<b>9 460 610 702</b>			
				06.95-05.96	WEG	<b>9 460 610 791</b>			
				04.99-10.99	KL,TW	<b>9 460 610 702</b>			
				12.99-02.02		<b>9 460 610 702</b>			
				92	TD27TI	01.96-12.06	DKF,EDC	<b>9 460 613 261</b>	
						11.96-10.97	DKF,EDC	<b>9 460 613 261</b>	
						10.97-12.06	BO,EDC	<b>0 460 404 974</b>	<b>0 986 440 508</b>
						11.98-12.99	EDC	<b>0 460 404 974</b>	<b>0 986 440 508</b>
						11.98-→		<b>9 461 610 088</b>	
						04.99-02.02	EDC,TW	<b>9 460 610 702</b>	
01.00-→		<b>9 460 613 261</b>							
<b>Urvan</b>									
3.0 DD ZDI Diesel	3,0	78	ZD30E	02.02-→		<b>0 470 504 029</b>			
<b>Xterra</b>									
2.8 D	2,8	97	4.07 TCA <Euro 2>	02.03-07.05		<b>0 460 424 245</b>			

OPEL

<b>Ascona</b>							
1.6 D [C]	1,6	40	16 D, 16 DA	09.87-08.88		<b>0 460 494 174</b>	
					AG	<b>0 460 494 175</b>	
				A	11.85-08.87	<b>0 460 494 174</b>	
					AG	<b>0 460 494 175</b>	
				A	11.85-08.87	<b>0 460 494 176</b>	
		AG	<b>0 460 494 177</b>				
<b>Astra</b>							
1.7 D [F]	1,7	42-44	17 D/DR <OHC>				
				Mot.Nr. →14363651	12.91-08.94	<b>0 460 494 293</b>	
				Mot.Nr. 14363652→	12.91-08.94	<b>0 460 494 330</b>	<b>0 986 440 143</b>
				DT [G]	03.98-08.00	<b>0 470 004 003</b>	<b>0 986 444 500</b>
				TD [F]	09.94-02.98	WEG	<b>0 460 494 353</b>
		WEG	<b>0 460 494 372</b>	<b>0 986 440 152</b>			





1.7 TD [F]	1,7	60	17 TD/TC4 <OHC EE1>		12.91-02.98	DKF, KL, WEG	9 460 620 011	
						DKF, KL, WEG	9 460 620 013	
						DKF, KL, WEG	9 460 620 020	
					Mot.Nr. →076350	12.91-02.98	DKF, KL, WEG	9 460 620 017
			Mot.Nr. 076351→	12.91-02.98	DKF, KL, WEG	9 460 620 021		
2.0 DT [G]	2,0	60	X 20 DTL <Turbo>		03.98-08.00	EU2, NC8	0 470 504 003	0 986 444 002
						EU3, NT5	0 470 504 011	0 986 444 012
DTI [G]	2,0	74	Y 20 DTH <Turbo>		09.99-01.05		0 470 504 011	0 986 444 012
			Fg.Nr. →Y2999999 →Y5999999 →Y6999999 →Y8999999 →YH999999	09.99-01.05			0 470 504 015	0 986 444 014
			Fg.Nr. 12000001→22999999 15000001→25999999 16000001→26999999 18000001→28999999 1H000001→2H999999					
			Fg.Nr. 32000001→35000001→ 36000001→38000001→3H000001→	09.99-01.05	THS	0 470 504 218	0 986 444 036	
DTL [G]	2,0	60	Y 20 DTL <Turbo>		09.00-01.04	EU2, NC8	0 470 504 003	0 986 444 002
						EU3, NT5	0 470 504 011	0 986 444 012
2.2 DTI [G]	2,2	92	Y 22 DTR <Turbo>		09.01-01.04	THS	0 470 504 209	0 986 444 028
			Fg.Nr. →22999999 →25999999 →26999999 →28999999 →2H999999	09.01-01.04	THS	0 470 504 219	0 986 444 037	
			Fg.Nr. 32000001→35000001→ 36000001→38000001→3H000001→					
<b>Astra Cabrio</b>								
2.2 DTI [G]	2,2	92	Y 22 DTR <Turbo>		03.02-08.05	THS	0 470 504 209	0 986 444 028
			Fg.Nr. →22999999 →25999999 →26999999 →28999999 →2H999999	03.02-08.05	THS	0 470 504 219	0 986 444 037	
			Fg.Nr. 32000001→35000001→ 36000001→38000001→3H000001→					
<b>Astra Caravan</b>								
1.7 D [F]	1,7	42-44	17 D/DR <OHC>		12.91-08.94		0 460 494 293	
			Mot.Nr. →14363651	12.91-08.94		0 460 494 330	0 986 440 143	
			Mot.Nr. 14363652→					
DT [G]	1,7	50	X 17 DTL <Turbo>		03.98-08.00		0 470 004 003	0 986 444 500
TD [F]	1,7	50	X 17 DTL <OHC>		09.94-02.98	WEG	0 460 494 353	0 986 440 150
						WEG	0 460 494 372	0 986 440 152
		60	17 TD/TC4 <OHC EE1>		12.91-02.98	DKF, KL, WEG	9 460 620 011	
						DKF, KL, WEG	9 460 620 013	
						DKF, KL, WEG	9 460 620 020	
			Mot.Nr. →076350	12.91-02.98	DKF, KL, WEG	9 460 620 017	9 460 620 017	
			Mot.Nr. 076351→	12.91-02.98	DKF, KL, WEG	9 460 620 021		
2.0 DT [G]	2,0	60	X 20 DTL <Turbo>		03.98-08.00	EU2, NC8	0 470 504 003	0 986 444 002
						EU3, NT5	0 470 504 011	0 986 444 012





◀ OPEL

<b>2.0 DTI [G]</b>	2,0	74	Y 20 DTH <Turbo>						
			Fg.Nr. →Y2999999 →Y5999999	09.00-06.04			<b>0 470 504 011</b>	<b>0 986 444 012</b>	
			→Y6999999 →Y8999999 →YH999999						
			Fg.Nr. 12000001→22999999	09.00-06.04			<b>0 470 504 015</b>	<b>0 986 444 014</b>	
			15000001→25999999						
			16000001→26999999						
			18000001→28999999						
			1H000001→2H999999						
			Fg.Nr. 32000001→ 35000001→	09.00-06.04	THS		<b>0 470 504 218</b>	<b>0 986 444 036</b>	
			36000001→ 38000001→ 3H000001→						
<b>DTL [G]</b>	2,0	60	Y 20 DTL <Turbo>	09.00-06.04	EU2,NC8		<b>0 470 504 003</b>	<b>0 986 444 002</b>	
					EU3,NT5		<b>0 470 504 011</b>	<b>0 986 444 012</b>	
<b>2.2 DTI [G]</b>	2,2	92	Y 22 DTR <Turbo>						
			Fg.Nr. →22999999 →25999999	09.01-06.04	THS		<b>0 470 504 209</b>	<b>0 986 444 028</b>	
			→26999999 →28999999 →2H999999						
			Fg.Nr. 32000001→ 35000001→	09.01-06.04	THS		<b>0 470 504 219</b>	<b>0 986 444 037</b>	
			36000001→ 38000001→ 3H000001→						
<b>Astra Coupé</b>									
<b>2.2 DTI [G]</b>	2,2	92	Y 22 DTR <Turbo>						
			Fg.Nr. →22999999 →25999999	03.02-02.05	THS		<b>0 470 504 209</b>	<b>0 986 444 028</b>	
			→26999999 →28999999 →2H999999						
			Fg.Nr. 32000001→ 35000001→	03.02-02.05	THS		<b>0 470 504 219</b>	<b>0 986 444 037</b>	
			36000001→ 38000001→ 3H000001→						
<b>Campo Pick-Up</b>									
<b>2.2 D [TFO]</b>	2,2	39-45	4 FD1	08.87-09.96	DKF		<b>9 460 610 332</b>		
<b>2.5 D [TFO]</b>	2,5	56	4 JA1	06.90-09.92	DKF		<b>9 460 610 377</b>		
					DKF,DRE		<b>9 460 610 378</b>		
				10.92-08.97	DKF		<b>9 460 610 603</b>		
					DKF,DRE		<b>9 460 610 604</b>		
<b>TD [TFO]</b>	2,5	56	4 JA1 T	10.89-08.97	DKF,EFV		<b>9 460 611 449</b>		
<b>3.1 TD [TFO]</b>	3,1	80	4 JG2 T	03.95-08.97	DKF		<b>9 460 610 963</b>		
<b>Combo</b>									
<b>1.7 D</b>	1,7	44	X 17 D 4EE1; 17 D <4EE1>						
			Mot.Nr. →076351	09.94-10.01	DKF,WEG		<b>9 460 620 010</b>	<b>9 460 620 010</b>	
			Mot.Nr. 076352→092141	09.94-10.01	DKF,WEG		<b>9 460 620 019</b>		
			Mot.Nr. 092142→	09.94-10.01	DKF,WEG		<b>9 460 620 023</b>		
			Mot.Nr. 877698→076351	09.94-10.01	DKF,WEG		<b>9 460 620 016</b>		
<b>Corsa</b>									
<b>1.5 D [A]</b>	1,5	37	15 D <4EC1-AAD OHC>	09.87-08.94	DKF,TW		<b>9 460 620 001</b>		
<b>D [B]</b>	1,5	37	15 D <4EC1>						
			Mot.Nr. →877695	03.93-08.00	DKF,WEG		<b>9 460 620 008</b>	<b>9 460 620 008</b>	
			Mot.Nr. 877696→	03.93-08.00	DKF,WEG		<b>9 460 620 014</b>		
<b>TD [A]</b>	1,5	49	15 DT/T4EC1-AAADT	03.88-08.94	DKF,TW		<b>9 460 620 002</b>		
<b>TD [B]</b>	1,5	49	15 TD <T4EC1 Turbo>	03.93-08.00	DKF,WEG		<b>9 460 620 009</b>	<b>9 460 620 009</b>	
			Mot.Nr. 877708→	03.93-08.00	DKF,WEG		<b>9 460 620 015</b>	<b>9 460 620 015</b>	
<b>XD [B]</b>	1,5	37	X 15 D <4EC1>						
			Mot.Nr. →877695	04.96-08.00	DKF,WEG		<b>9 460 620 008</b>	<b>9 460 620 008</b>	
			Mot.Nr. 877696→	04.96-08.00	DKF,WEG		<b>9 460 620 014</b>		
<b>XTD [B]</b>	1,5	49	X 15 TD <4EE1 Turbo>	04.96-08.00	DKF,WEG		<b>9 460 620 009</b>	<b>9 460 620 009</b>	
			Mot.Nr. 877708→	04.96-08.00	DKF,WEG		<b>9 460 620 015</b>	<b>9 460 620 015</b>	
<b>1.7 D [B]</b>	1,7	44	X 17 D <4EE1>						
			Mot.Nr. →076351	04.96-08.00	DKF,WEG		<b>9 460 620 010</b>	<b>9 460 620 010</b>	
			Mot.Nr. 076352→092141	04.96-08.00	DKF,WEG		<b>9 460 620 019</b>		
			Mot.Nr. 092142→	04.96-08.00	DKF,WEG		<b>9 460 620 023</b>		
			Mot.Nr. 877698→076351	04.96-08.00	DKF,WEG		<b>9 460 620 016</b>		
			17 D <4EE1>						
			Mot.Nr. →076351	03.93-08.00	DKF,WEG		<b>9 460 620 010</b>	<b>9 460 620 010</b>	
			Mot.Nr. 076352→092141	03.93-08.00	DKF,WEG		<b>9 460 620 019</b>		
			Mot.Nr. 092142→	03.93-08.00	DKF,WEG		<b>9 460 620 023</b>		
			Mot.Nr. 877698→076351	03.93-08.00	DKF,WEG		<b>9 460 620 016</b>		
<b>D Utility [B]</b>	1,7	42	X 17 D4EE1	09.98-10.05			<b>9 460 620 023</b>		
<b>170 D Utility [B]</b>	1,7	42	X 17 D	09.00-12.02			<b>9 460 620 023</b>		



Frontera												
2.2 DTI [B]	2,2	85	X 22 DTH <Turbo>	09.98-10.02		0 470 504 009	0 986 444 005					
		88	Y 22 DTH <Turbo>	09.02-09.04	THS	0 470 504 217	0 986 444 030					
2.3 TD [A]	2,3	74	23 DT <Turbo>	09.91-08.95		0 460 404 056						
					KAT	0 460 404 074	0 986 440 002					
2.5 TDS Turbo [A]	2,5	85	VM 41 B <Venturi-25TD>	06.96-08.98		0 460 404 991						
2.8 TDI [A]	2,8	83	4JB1T <(28TD)>	02.95-08.98	DKF,WEG	9 460 611 452						
			Fg.Nr. →SV799999	02.95-08.98	DKF,WEG	9 460 610 708						
Kadett												
1.5 TD [E]	1,5	53	15 DT <T4EC1>	09.88-08.91	DKF	9 460 620 007						
1.6 D [E]	1,6	40	16 D, DA <OHC>	09.87-01.89		0 460 494 174						
					AG	0 460 494 175						
					A 11.85-08.87	0 460 494 174						
					AG	0 460 494 175						
					A 11.85-08.87	0 460 494 176						
1.7 D/DR [E]	1,7	42	17 D/DR <OHC>	02.89-08.91	AG	0 460 494 230						
					CSA	0 460 494 229						
					DKF	9 460 620 007						
TD [E]	1,7	60	17 DT /TC4 EE1	02.90-08.91	DKF	9 460 620 007						
Monterey												
3.1 TD [A]	3,1	84	4JG2 TC <OHV>	09.93-07.96	WEG	9 460 610 626						
				05.95-07.96	WEG	9 460 610 950						
				07.95-07.96	FHE	9 460 610 951						
					FHE,WEG	9 460 610 952						
				08.96-12.97	WEG	9 460 611 262						
					FFK,WEG	9 460 611 100						
					KL,WEG	9 460 611 263						
					OWO	9 460 611 099						
				CH 09.91-12.91		9 460 610 657						
				01.92-08.93		9 460 610 544						
CH 09.91-12.91		9 460 610 656										
01.92-08.92		9 460 610 596	9 460 610 596									
09.92-08.93		9 460 610 609										
Omega												
2.0 DTI Turbo [B]	2,0	74	X 20 DTH	09.97-08.00	EU2,NC8 FD3,NT5	0 470 504 009	0 986 444 005					
2.2 DTI [B]	2,2	88	Y 22 DTH <Turbo>	06.00-07.03	NC9	0 470 504 016	0 986 444 021					
2.3 D [A]	2,3	54	23 YD	09.86-03.94	GS	0 460 494 197						
					Mot.Nr. 00173159→	AG	0 460 494 231					
					Mot.Nr. 00173159→01194897	GS	0 460 494 232					
					Mot.Nr. 01194898→	GS	0 460 494 316					
					TD [A]	2,3	66	23 YDT	09.86-08.88	AGR,GS	0 460 404 056	
										GS,KAT	0 460 404 074	0 986 440 002
								Fg.Nr. K1000099→	09.86-08.88	EEC,GS, LLE	0 460 404 055	
										EEC,GS, RLE	0 460 404 071	
								Fg.Nr. →K1000098	09.86-08.88	AG	0 460 404 048	
										GS	0 460 404 037	
		74	23 DTR	09.88-03.94	AGR,GS	0 460 404 056						
					GS,KAT	0 460 404 074	0 986 440 002					
			Fg.Nr. K1000099→	09.88-03.94	EEC,GS, LLE	0 460 404 055						
					EEC,GS, RLE	0 460 404 071						
			Fg.Nr. →K1000098	09.88-03.94	AG	0 460 404 048						
					GS	0 460 404 037						
2.5 TD [B]	2,5	96	U 25 TD; X 25 TD	04.94-02.01		0 460 406 994	0 986 440 516					
Rekord												
2.3 D [E]	2,3	52	23 D	05.83-08.86		0 460 494 127						
TD [E]	2,3	63	23 DT	06.84-08.86		0 460 404 037						





◀ OPEL

<b>Senator</b>									
2.3 TD [A]	2,3	64	23 TD		11.84-08.87				<b>0 460 404 036</b>
								AG	<b>0 460 404 039</b>
<b>Signum</b>									
2.0 DTI	2,0	74	Y 20 DTH <Ecotec>		05.03-09.05	THS			<b>0 470 504 217 0 986 444 030</b>
2.2 DTI	2,2	86-92	Y 22 DTR <Ecotec>		05.03-09.05	THS			<b>0 470 504 217 0 986 444 030</b>
<b>Sintra</b>									
2.2 TD	2,2	85	X 22 DTH <Turbo>		09.97-09.99				<b>0 470 504 009 0 986 444 005</b>
<b>Vectra</b>									
1.7 D [A]	1,7	42	17 D/DR						
			Fg.Nr. NV100001→N1000001→N5000001→		10.88-08.95				<b>0 460 494 293</b>
			Fg.Nr. →MV999999 →M1999999 →M5999999		10.88-08.95	CSA			<b>0 460 494 229</b>
TD [A]	1,7	60	X 17 DT <TC4 EE1>						
			Fg.Nr. R1000001→R5000001→R7500001→		03.90-08.95	DKF,WEG			<b>9 460 620 011</b>
						DKF,WEG			<b>9 460 620 017</b>
			Fg.Nr. →P1999999 →P5999999 →P7599999		03.90-08.95	DKF,WEG			<b>9 460 620 007 9 460 620 007</b>
TD [B]	1,7	60	X 17 TD <TC4 EE1>; X 17 TD <TC4 EE1 Turbo>		09.95-09.98	DKF,KL,			<b>9 460 620 011</b>
						WEG			
						DKF,KL,			<b>9 460 620 013</b>
						WEG			
						DKF,KL,			<b>9 460 620 020</b>
						WEG			
			Mot.Nr. →076356		09.95-09.98	DKF,KL,			<b>9 460 620 017 9 460 620 017</b>
						WEG			
			Mot.Nr. 076357→		09.95-09.98	DKF,KL,			<b>9 460 620 021</b>
						WEG			
2.0 DI [B]	2,0	60	X 20 DTL <Ecotec 16V Turbo>; X 20 DTL 16V Turbo <Ecotec>		09.96-08.02	EU2,NC8			<b>0 470 504 003 0 986 444 002</b>
						FD3,NT5			<b>0 470 504 011 0 986 444 012</b>
						TW			<b>0 470 504 002 0 986 444 001</b>
DTI [B]	2,0	74	X 20 DTH		09.97-08.03	EU2,NC8			<b>0 470 504 004 0 986 444 003</b>
						EU3,NT5			<b>0 470 504 011 0 986 444 012</b>
			Y 20 DTH		09.00-09.03				<b>0 470 504 015 0 986 444 014</b>
DTI, DTI GTS [C]	2,0	74	Y 20 DTH <Ecotec>		04.02-09.05	THS			<b>0 470 504 210 0 986 444 029</b>
2.2 DTI [B]	2,2	92	Y 22 DTR <Ecotec>		09.00-09.03				<b>0 470 504 016 0 986 444 021</b>
DTI, DTI GTS [C]	2,2	86-92	Y 22 DTR <Turbo Ecotec>		04.02-09.05	THS			<b>0 470 504 209 0 986 444 028</b>
<b>Vectra Caravan</b>									
1.7 TD [B]	1,7	60	X 17 TD <TC4 EE1 Turbo>		09.95-09.98	DKF,KL,			<b>9 460 620 011</b>
						WEG			
						DKF,KL,			<b>9 460 620 013</b>
						WEG			
						DKF,KL,			<b>9 460 620 020</b>
						WEG			
			Mot.Nr. →076356		09.95-09.98	DKF,KL,			<b>9 460 620 017 9 460 620 017</b>
						WEG			
			Mot.Nr. 076357→		09.95-09.98	DKF,KL,			<b>9 460 620 021</b>
						WEG			
2.0 DI [B]	2,0	60	X 20 DTL <16V Turbo Ecotec>		09.96-08.00	EU2,NC8			<b>0 470 504 003 0 986 444 002</b>
						FD3,NT5			<b>0 470 504 011 0 986 444 012</b>
						TW			<b>0 470 504 002 0 986 444 001</b>
DTI [B]	2,0	74	X 20 DTH		09.97-08.03	EU2,NC8			<b>0 470 504 004 0 986 444 003</b>
						EU3,NT5			<b>0 470 504 011 0 986 444 012</b>
			Y 20 DTH		09.00-09.03				<b>0 470 504 015 0 986 444 014</b>
DTI [C]	2,0	74	Y 20 DTH <Turbo Ecotec>		09.03-09.05	THS			<b>0 470 504 210 0 986 444 029</b>
2.2 DTI [B]	2,2	92	Y 22 DTR <Ecotec>		09.00-09.03				<b>0 470 504 016 0 986 444 021</b>
DTI [C]	2,2	86-92	Y 22 DTR <Turbo Ecotec>		09.03-09.05	THS			<b>0 470 504 209 0 986 444 028</b>
<b>Zafira</b>									
2.0 DI [A]	2,0	60	X 20 DTL <Turbo>		03.99-08.00	EU2,NC8			<b>0 470 504 003 0 986 444 002</b>
						EU3,NT5			<b>0 470 504 011 0 986 444 012</b>
DTI [A]	2,0	74	Y 20 DTH <Turbo>						
			Fg.Nr. →22999999		04.99-07.05				<b>0 470 504 015 0 986 444 014</b>
			Fg.Nr. 32000001→35000001→36000001→		04.99-07.05	AG,THS			<b>0 470 504 217 0 986 444 030</b>
			38000001→3H000001→4G000001→			GS,THS			<b>0 470 504 218 0 986 444 036</b>



2.2 DTI [A]	2,2	92	Y 22 DTR <Turbo> Fg.Nr. →22999999 →25999999 →26999999 →28999999 →2H999999	03.02-07.05	THS	<b>0 470 504 209</b>	<b>0 986 444 028</b>
				03.02-07.05	THS	<b>0 470 504 219</b>	<b>0 986 444 037</b>
			Fg.Nr. 32000001 → 35000001 → 36000001 → 38000001 → 3H000001 →				

**PEUGEOT**

**Expert**

1.9 D [U64]	1,9	51-52	D9B <XUD9>	09.95-05.00	CSA,WEK	<b>0 460 484 098</b>				
					OWK	<b>0 460 484 097</b>				
					OWO	<b>0 460 484 064</b>	<b>0 986 440 094</b>			
					WOK	<b>0 460 484 091</b>				
D Turbo [U64]	1,9	66-68	DHX <XUD9TE>	09.95-05.00	WEG	<b>0 460 494 423</b>	<b>0 986 440 156</b>			
					WEG	<b>0 460 494 427</b>				
					Org.Nr. 7632 → 7664	10.97-11.97	WZT	<b>0 460 494 447</b>		
					Org.Nr. 7665 →	12.97-05.00	EFV,WZT	<b>0 460 494 455</b>	<b>0 986 440 161</b>	
					68	D8B <XUD9TE>	09.95-07.98	CSA,N09, WEK	<b>0 460 494 412</b>	
					WEG		<b>0 460 494 423</b>	<b>0 986 440 156</b>		
					N03,WEG		<b>0 460 494 384</b>			
					N09,OWK		<b>0 460 494 411</b>			
					N09,OWO		<b>0 460 494 370</b>			
					N09,WOK		<b>0 460 494 388</b>			

**P 4**

2.5 D	2,5	56	155 PB <XD3>	10.86-12.96		<b>0 460 494 125</b>	
-------	-----	----	--------------	-------------	--	----------------------	--

**Partner**

1.9 D	1,9	51	DW8	10.99 →		<b>0 460 494 463</b>					
					D [M4]	1,9	50	DJY <XUD9Y>	07.96-08.02	BOW	<b>0 460 484 070</b>
							Org.Nr. →7539	07.96-07.97	BOW	<b>0 460 484 109</b>	
							Org.Nr. 7540 → 7664	08.97-11.97	BO,WZT	<b>0 460 484 132</b>	
							Org.Nr. 7665 →	12.97-08.02	BO,EFV, WZT	<b>0 460 484 137</b>	
		51	WJZ <DW8>	11.98-08.02	BOW	<b>0 460 494 462</b>					
					<del>BOW</del>	<b>0 460 494 463</b>					

**Ranch**

1.9 D [M4]	1,9	51	WJZ <DW8>	11.98-08.02	BOW	<b>0 460 494 462</b>	
					<del>BOW</del>	<b>0 460 494 463</b>	

**106**

1.5 D [S1]	1,5	40-42	VJY <TUD5>; VJZ <TUD5>	07.94-04.96	BO,N03	<b>0 460 484 078</b>			
					D [S2]	1,5	40	VJY <TUD5>	05.96-05.05
						Org.Nr. →7510	05.96-06.97	BOW,CSA	<b>0 460 484 100</b>
						Org.Nr. 7511 → 7706	07.97-01.98	BO,WZT	<b>0 460 484 138</b>
						Org.Nr. 7707 →	02.98-05.05	BO,WZT	<b>0 460 484 142</b>
		40-42	VJZ <TUD5>	05.96-05.05	AGF,BOW, CSA	<b>0 460 484 100</b>			
						<del>BOW,KL</del>	<b>0 460 484 078</b>		
						<del>BOW,KL</del>	<b>0 460 484 099</b>		
						<del>BOW,VAE</del>	<b>0 460 484 099</b>		
						Org.Nr. →7510	05.96-06.97	BOW,CSA, VAE	<b>0 460 484 100</b>
						Org.Nr. 7511 → 7706	07.97-01.98	BO,WZT	<b>0 460 484 138</b>
						Org.Nr. 7707 →	02.98-05.05	BO,WZT	<b>0 460 484 142</b>
		42	VJX <TUD5B>	07.00-05.05				<b>0 460 484 148</b>	

**205**

1.8 D	1,8	44	A9A,161A <XUD7>	07.87-10.87	BO	<b>0 460 484 010</b>		
						11.87-01.90	BO	<b>0 460 484 014</b>
						R171-1 <XUD7>	10.83-10.87	BO
1.9 D	1,9	47	DJZ,162 <XUD9>	10.87-07.92	AGF,BO	<b>0 460 494 224</b>		
						08.92-09.98	AGF,BO	<b>0 460 494 279</b>













◀ PEUGEOT

205 Pickup								
1.8 D	1,8	44	<XUD7>	05.85-10.87	BO	0 460 484 010		
				11.87-01.90	BO	0 460 484 014		
				02.90-07.92	BO	0 460 484 034		
				08.92-09.98	BO	0 460 484 056		
305								
1.8 D	1,8	44	161A <XUD7>	Fg.Nr. →9743923	10.82-10.86	BO	0 460 484 010	
				Fg.Nr. 9743924→	10.86-06.88	BO	0 460 484 014	
1.9 D	1,9	48	162,D9A <XUD9>	03.87-09.87	AGF,BO	0 460 494 215		
				10.87-07.90	BO	0 460 494 223		
				Fg.Nr. →9743923	10.83-10.86	BO	0 460 494 153	
			Fg.Nr. 9743924→	10.86-09.87	BO	0 460 494 195		
306								
1.8 D [N3]	1,8	44	A9A <XUD7>; 161A <XUD7>	05.93-04.97	BO,WEG	0 460 484 056		
1.9 D	1,9	50	<XUD9>	10.97-12.97	KL	0 460 484 064 0 986 440 094		
				10.97→		0 460 484 091		
				01.98→	CSA,KL	0 460 484 098		
D [N3]	1,9	47-48	DJZ <XUD9Y>	05.93-06.94	BO	0 460 494 279		
				07.94-04.97	BO,WEG	0 460 484 070		
		50	DJY <XUD9Y>	Org.Nr. →7144	06.95-06.96	BO,WEG	0 460 484 093	
				Org.Nr. 7145→	07.96-04.97	BO,WEG	0 460 484 109	
51	D9B <XUD9A>	05.93-04.97	BO	0 460 484 064 0 986 440 094				
		BO,WEG	0 460 484 091					
D [N5]	1,9	50	DJY <XUD9>	05.97-10.03	BO,WZT	0 460 484 137		
				BO,W	0 460 484 070			
				05.97-10.03	CSA,WEK	0 460 484 098		
D Turbo [N3]	1,9	66-67	DHY <XUD9TE>	09.98-10.03	BO	0 460 494 467		
				05.93-04.97	BO,WEG	0 460 494 344		
				05.93-11.94	BO,WEG	0 460 494 342		
D Turbo [N5]	1,9	55	DHW <XUD9BSD>	12.94-04.97	BO,WEG	0 460 494 370		
				06.95-04.97	BO,WEG	0 460 494 388		
				06.98-10.03	BO,WZT	0 460 484 131		
306 Break								
1.9 D [N5]	1,9	50	DJY <XUD9>	05.97-03.02	BO,WZT	0 460 484 137		
				BO,W	0 460 484 070			
				05.97-03.02	CSA,WEK	0 460 484 098		
D Turbo [N5]	1,9	55	DHW <XUD9BSD>	09.98-03.02	BO	0 460 494 467		
				06.98-03.02	BO,WZT	0 460 484 131		
309								
1.8 D	1,8	44	161A,A9A <XUD7>	06.86-09.87	BO	0 460 484 010		
				10.87-01.90	BO	0 460 484 014		
				02.90-03.93	BO	0 460 484 034		
1.9 D	1,9	47	DJZ <XUD9Y>	06.86-12.93	AGF	0 460 494 224		
				06.86-10.86	BO	0 460 494 153		
				11.86-09.87	BO	0 460 494 195		
				10.87-12.93	BO	0 460 494 223		
1.9 D	1,9	47	162,D9A <XUD9>					
405								
1.8 D Turbo [15]	1,8	64-66	AJZ <XUD7TEY>	10.90-12.92	BO,KAT	0 460 484 038		
				03.88-12.92	BO	0 460 484 019		
1.9 D	1,9	50	XUD9	03.95→		0 460 484 064 0 986 440 094		
				04.96→		0 460 494 370		
				03.98-07.99		0 460 494 370		
D [4]	1,9	47	DJZ <XUD9Y>	06.92-06.94	BO	0 460 494 279		
				07.94-01.95	BO	0 460 484 070		
				07.94-04.97	BOW	0 460 484 093		
D [15]	1,9	47	DJY <XUD9Y>	02.95-04.97	BOW	0 460 484 070		
				06.92-10.94	BOW	0 460 484 054		
				06.92-04.97	BOW	0 460 484 091		
				11.94-04.97	BOW,EFV	0 460 484 064 0 986 440 094		
				07.88-09.92	AGF,BO	0 460 494 224		
D [15]	1,9	51	D9B <XUD9A>	03.88-12.92	BO	0 460 494 240		



									
<b>1.9 D Turbo [4]</b>	1,9	66-68	DHY <XUD9TE Kat.>	06.92-11.94	BOW		<b>0 460 494 309</b>		
				12.94-04.97	BOW		<b>0 460 494 344</b>		
	68	D8A <XUD9TE>	06.92-04.94	BO,KAT		<b>0 460 494 278</b>			
			04.94-11.94	BO		<b>0 460 494 278</b>			
			12.94-04.97	BOW		<b>0 460 494 388</b>			
					BOW		<b>0 460 494 370</b>		
<b>405 Break</b>									
<b>1.8 D Turbo [15]</b>	1,8	64-66	AJZ <XUD7TEY> A8A,A8B <XUD7TE>	10.90-12.92	BO,KAT		<b>0 460 484 038</b>		
				07.88-12.92	BO		<b>0 460 484 019</b>		
<b>1.9 D [4]</b>	1,9	47	DJZ <XUD9Y> DJY <XUD9Y>	06.92-06.94	BO		<b>0 460 494 279</b>		
				07.94-01.95	BO		<b>0 460 484 070</b>		
				07.94-04.97	BOW		<b>0 460 484 093</b>		
	51-52	D9B <XUD9A>	02.95-04.97	BOW		<b>0 460 484 070</b>			
			06.92-10.94	BOW		<b>0 460 484 054</b>			
				06.92-04.97	BOW		<b>0 460 484 091</b>		
				11.94-04.97	BOW,EFV		<b>0 460 484 064</b>	<b>0 986 440 094</b>	
D [15]	1,9	47	DJZ <XUD9Y> D9B <XUD9A>	07.88-09.92	AGF,BO		<b>0 460 494 224</b>		
				07.88-12.92	BO		<b>0 460 494 240</b>		
D Turbo [4]	1,9	66-68	DHY <XUD9TE Kat.> D8A <XUD9TE>	06.92-11.94	BOW		<b>0 460 494 309</b>		
				12.94-04.97	BOW		<b>0 460 494 344</b>		
				04.94-11.94	BO		<b>0 460 494 278</b>		
				12.94-04.97	BOW		<b>0 460 494 388</b>		
					BOW		<b>0 460 494 370</b>		
<b>406</b>									
<b>1.9 D Turbo [D8]</b>	1,9	66-68	DHX <XUD9TE> Org.Nr. →7144 Org.Nr. 7145→ Org.Nr. 7632→7664 Org.Nr. 7665→ D8B <XUD9TE>	12.95-03.99	WEG		<b>0 460 494 367</b>		
				12.95-06.96	WEG		<b>0 460 494 382</b>		
				07.96-03.99	WEG		<b>0 460 494 427</b>		
				10.97-11.97	WZT		<b>0 460 494 447</b>		
				12.97-03.99	WZT		<b>0 460 494 455</b>	<b>0 986 440 161</b>	
				12.95-03.99	CSA,N09, WEK OWK OWO WOK		<b>0 460 494 412</b>		
					OWK		<b>0 460 494 411</b>		
					OWO		<b>0 460 494 409</b>		
					WOK		<b>0 460 494 410</b>		
<b>406 Break</b>									
<b>1.9 D Turbo [D8]</b>	1,9	66-68	DHX <XUD9TE> Org.Nr. 7632→7664 Org.Nr. 7665→ D8B <XUD9TE>	10.96-03.99	WEG		<b>0 460 494 367</b>		
					WEG		<b>0 460 494 427</b>		
				10.97-11.97	WZT		<b>0 460 494 447</b>		
				12.97-03.99	WZT		<b>0 460 494 455</b>	<b>0 986 440 161</b>	
				10.96-03.99	CSA,N09, WEK OWK OWO WOK		<b>0 460 494 412</b>		
					OWK		<b>0 460 494 411</b>		
					OWO		<b>0 460 494 409</b>		
					WOK		<b>0 460 494 410</b>		
<b>504 Pickup</b>									
<b>2.5 D</b>	2,5	55	<XD3>	07.87-12.89	CSA		<b>0 460 494 079</b>		
<b>505</b>									
<b>2.3 D Turbo</b>	2,3	54-59	147 <XD2S>	09.80-06.86	AG		<b>0 460 404 018</b>		
					CSA		<b>0 460 404 011</b>		
<b>2.5 D</b>	2,5	51-56	155 <XD3>	06.81-12.93	BO,CSA		<b>0 460 494 079</b>		
					BO		<b>0 460 494 121</b>		
	D Turbo	2,5	66-70	152A, 152Y <XD3T> Fg.Nr. 1578001→	10.83-02.86	BO		<b>0 460 494 121</b>	
					02.86-12.93	AG,BO		<b>0 460 494 123</b>	
					BO		<b>0 460 494 158</b>		
		77	152B <XD3TE> Fg.Nr. 1965001→	A,D 10.86-12.93	BO		<b>0 460 494 998</b>		
<b>604</b>									
<b>2.5 D Turbo</b>	2,5	66-70	152A <XD3T>	06.83-06.86			<b>0 460 494 121</b>		
					AG		<b>0 460 494 123</b>		
<b>605</b>									
<b>2.1 D [Y30]</b>	2,1	60-61	PJZ <XUD11A> P9A <XUD11A>	06.92-10.92	BO		<b>0 460 494 265</b>		
				06.89-10.92	BO		<b>0 460 494 265</b>		





◀ PEUGEOT

<b>2.1 D Turbo [Y30]</b>	2,1	80-81	PHZ <XUD11ATE>	06.89-06.95	AG,VAE	<b>0 460 494 276</b>			
					GS,VAE	<b>0 460 494 255</b>			
				06.92-06.95	AGF,GS	<b>0 460 494 310</b>			
				10.92-06.95	AG,AGF	<b>0 460 494 313</b>			
				07.95-10.96	AG,AGF	<b>0 460 494 386</b>			
					AG,VAE	<b>0 460 494 385</b>			
				P8A <XUD11ATE>	06.89-06.92	BO	<b>0 460 494 264</b>		
					06.89-10.92	AG,BO	<b>0 460 494 275</b>		
					06.89-07.95	AG,VAE	<b>0 460 494 276</b>		
					06.92-07.95	AGF,GS	<b>0 460 494 310</b>		
					10.92-07.95	AG,AGF	<b>0 460 494 313</b>		
					P8B <XUD11ATE>	06.92-10.92	AG,BO	<b>0 460 494 275</b>	
				06.92-06.95		AGF,GS	<b>0 460 494 310</b>		
						AG,VAE	<b>0 460 494 276</b>		
				10.92-06.95		AG,AGF	<b>0 460 494 313</b>		
07.95-10.96	AG,AGF	<b>0 460 494 386</b>							
	AG,VAE	<b>0 460 494 385</b>							
<b>2.5 D Turbo [Y30]</b>	2,5	94-96	THY <DK5ATE>	07.94-05.99		<b>0 460 404 993</b>	<b>0 986 440 512</b>		
<b>806</b>									
<b>1.9 D Turbo [U60]</b>	1,9	66	DHX <XUD9TE>	12.94-08.02	N05,WEG	<b>0 460 494 367</b>			
					N05,WEG	<b>0 460 494 427</b>			
				10.97-11.97	WZT	<b>0 460 494 447</b>			
				12.97-08.02	EFV,WZT	<b>0 460 494 455</b>	<b>0 986 440 161</b>		
				66-68	D8B <XUD9TE>	12.94-08.02	AGF,OWK	<b>0 460 494 411</b>	
						AGF,WOK	<b>0 460 494 384</b>		
					N09,OWO	<b>0 460 494 370</b>			
				09.95-08.02	CSA,N09,	<b>0 460 494 412</b>			
					WEK				
				12.94-12.95	N03,WEG	<b>0 460 494 341</b>			
					N07,WEG	<b>0 460 494 371</b>			
				01.96-08.02	N03,WEG	<b>0 460 494 423</b>	<b>0 986 440 156</b>		

**RENAULT**

**Clio I**

<b>1.9 D</b>	1,9	47	F8Q 732	03.96-05.97		<b>0 460 484 061</b>		
				06.97→		<b>0 460 484 049</b>		
D [X57]	1,9	47	F8Q 678	10.94-08.96	BO	<b>0 460 484 073</b>		
				09.96-02.98	BO	<b>0 460 484 120</b>		
			F8Q 732	06.90-02.98		<b>0 460 484 049</b>		
			47-48	F8Q 730	06.90-08.96	BO	<b>0 460 484 048</b>	
					09.96-02.98	BO	<b>0 460 484 122</b>	

**Clio II**

<b>1.9 D DTI [BB./CB./SB.]</b>	1,9	59	F9Q 780	03.99-10.07		<b>0 460 414 988</b>	<b>0 986 440 520</b>
			F9Q 782	08.00-10.07		<b>0 460 414 983</b>	

**Espace I**

<b>2.1 D Turbo [J11/13]</b>	2,1	65	J8S 240; J8S 774	10.84-12.90		<b>0 460 494 141</b>	
-----------------------------	-----	----	------------------	-------------	--	----------------------	--

**Espace II**

<b>2.1 D Turbo [J63]</b>	2,1	65	J8S 776	01.91-09.96		<b>0 460 494 303</b>		
			J8S 778	06.92-09.96	KL	<b>0 460 494 328</b>		
					KL	<b>0 460 494 329</b>		
			65/66	J8S 610; J8S 612	06.92-09.96	KL	<b>0 460 494 326</b>	
						KL,WEG	<b>0 460 494 377</b>	
						KL,LH	<b>0 460 494 327</b>	
D Turbo 4x4 [J63]	2,1	65	J8S 772	01.91-10.93	KL	<b>0 460 494 248</b>		
					KL	<b>0 460 494 249</b>		

**Espace III**

<b>1.9 dTi [JE0]</b>	1,9	72	F9Q 720	02.99-10.02		<b>0 460 414 993</b>	<b>0 986 440 523</b>
			F9Q 722	10.99-10.02		<b>0 460 414 988</b>	<b>0 986 440 520</b>





2.2 D Turbo [JEO]	2,2	83	G8T 714	10.96-10.97		0 460 494 443			
				11.97-10.02		0 460 494 454			
				G8T 716	10.96-10.97	CSA, KL	0 460 494 439		
						KL	0 460 494 440		
			11.97-10.02		0 460 494 451				
<b>Express</b>									
1.9 D	1,9	40	F8Q 682	09.96-09.02	BO	0 460 484 120			
<b>Express, Extra, Rapid</b>									
1.6 D [F40]	1,6	40	F8M 720; F8M 730; F8M 736; F8M 760	03.86-03.97	BO	0 460 494 105			
1.9 D [F40]	1,9	40	F8Q 640	09.94-08.96	BO	0 460 484 073			
				09.96-03.97	BO, WEG	0 460 484 120			
					BO, WFS	0 460 484 121			
				F8Q 682	04.97-09.97	BO, WEG	0 460 484 120		
						BO, WFS	0 460 484 121		
				47-48	F8Q 646	06.96-08.96		0 460 484 103	
					F8Q 680	09.96-03.97	BO	0 460 484 119	
					F8Q 680	04.97-09.97	BO	0 460 484 119	
					F8Q 684	04.97-09.97	BO, WEG	0 460 484 122	
						BO, WFS	0 460 484 123		
					F8Q 724,732	09.91-08.96	BO	0 460 484 044	
					F8Q 776,730	09.91-08.96	BO	0 460 484 048	
						09.96-03.97	BO, WEG	0 460 484 122	
			BO, WFS	0 460 484 123					
<b>Kangoo I</b>									
1.9 DTI [FC./KC.]	1,9	59	F9Q 780	09.98-12.07		0 460 414 988	0 986 440 520		
DTI, DTI 4x4 [FC./KC.]	1,9	59	F9Q 782	02.00-12.07		0 460 414 983			
<b>Laguna I</b>									
1.9 DTI [B56]	1,9	72	F9Q 710	09.99-02.01		0 460 414 988	0 986 440 520		
				F9Q 716	10.97-09.99		0 460 414 993	0 986 440 523	
				F9Q 717	04.99-02.01		0 460 414 988	0 986 440 520	
2.2 D [B56]	2,2	61-63	G8T 706	01.94-10.95	KL, WEG	0 460 494 332			
					KL, WEG	0 460 494 333			
				G8T 752	11.95-02.01	KL, WEG	0 460 494 357		
						KL, WEG	0 460 494 396		
						KL, WEG	0 460 494 358		
						KL, WEG	0 460 494 397		
				G8T 790	01.94-10.95	CSA, WEG	0 460 494 406		
						KL, WEG	0 460 494 332		
						KL, WEG	0 460 494 333		
				G8T 792	09.95-08.96	KL, WEG	0 460 494 375		
						KL, WEG	0 460 494 376		
					09.96-10.97	KL, WEG	0 460 494 435		
						KL, WEG	0 460 494 436		
					11.97-02.01	CSA	0 460 494 452		
				G8T 794	10.95-02.01	KL, WEG	0 460 494 357		
						KL, WEG	0 460 494 396		
						KL, WEG	0 460 494 358		
	KL, WEG	0 460 494 397							
D Turbo [B56]	2,2	83-85	G8T 760	02.96-08.96	KL, WEG	0 460 494 393	0 986 440 205		
				02.96-09.96	KL, WEG	0 460 494 394			
				09.96-10.97	KL, WEG	0 460 494 437			
				10.96-10.97	KL, WEG	0 460 494 438			
				11.97-02.01		0 460 494 449			
<b>Laguna I Grandtour</b>									
1.9 DTI [K56]	1,9	72	F9Q 710	09.99-02.01		0 460 414 988	0 986 440 520		
				F9Q 716	10.97-09.99		0 460 414 993	0 986 440 523	
				F9Q 717	04.99-02.01		0 460 414 988	0 986 440 520	
DTI [S56]	1,9	72	F9Q 716	03.98-02.01		0 460 414 993	0 986 440 523		





◀ RENAULT

2.2 D [K56]	2,2	61-63	G8T 706	02.95-10.95	KL,WEG	0 460 494 332							
					KL,WEG	0 460 494 333							
			G8T 752	11.95-02.01	KL,WEG	0 460 494 357							
					KL,WEG	0 460 494 396							
					KL,WEG	0 460 494 358							
					KL,WEG	0 460 494 397							
					KL,WEG	0 460 494 332							
			G8T 790	06.95-07.95	KL,WEG	0 460 494 332							
					KL,WEG	0 460 494 333							
			G8T 792	08.95-10.95	CSA,WEG	0 460 494 406							
					KL,WEG	0 460 494 375							
				09.95-08.96	KL,WEG	0 460 494 376							
					KL,WEG	0 460 494 435							
					KL,WEG	0 460 494 436							
			G8T 794	11.97-02.01	CSA	0 460 494 452							
KL,WEG	0 460 494 357												
11.95-02.01	KL,WEG	0 460 494 396											
	KL,WEG	0 460 494 358											
	KL,WEG	0 460 494 397											
D [S56]	2,2	61-63	G8T 706	02.95-10.95	KL,WEG	0 460 494 332							
					KL,WEG	0 460 494 333							
			G8T 752	11.95-02.01	KL,WEG	0 460 494 357							
					KL,WEG	0 460 494 396							
					KL,WEG	0 460 494 358							
					KL,WEG	0 460 494 397							
					KL,WEG	0 460 494 332							
			G8T 792	09.95-08.96	KL,WEG	0 460 494 375							
					KL,WEG	0 460 494 376							
				09.96-10.97	KL,WEG	0 460 494 435							
					KL,WEG	0 460 494 436							
					CSA	0 460 494 452							
D Turbo [K56]	2,2	83-85	G8T 760	02.96-08.96	KL,WEG	0 460 494 393	0 986 440 205						
					02.96-09.96	KL,WEG	0 460 494 394						
					09.96-10.97	KL,WEG	0 460 494 437						
					10.96-10.97	KL,WEG	0 460 494 438						
					11.97-02.01		0 460 494 449						
					D Turbo [S56]	2,2	83-85	G8T 760	02.96-08.96	KL,WEG	0 460 494 393	0 986 440 205	
										02.96-09.96	KL,WEG	0 460 494 394	
										09.96-10.97	KL,WEG	0 460 494 437	
10.96-10.97	KL,WEG	0 460 494 438											
11.97-02.01		0 460 494 449											
<b>Megane</b>													
1.9 D	1,9	68	F9QT	06.99→		0 460 414 988	0 986 440 520						
<b>Megane I</b>													
1.9 D [X64]	1,9	47	F8Q 620	01.96-08.96	CSA,KL	0 460 484 075							
					KL	0 460 484 074							
				09.96-02.99	KL	0 460 484 114							
					KL	0 460 484 115							
					01.96-08.96	CSA,KL	0 460 484 075						
						KL	0 460 484 074						
		47-48	01.96-03.97	CSA,KL	0 460 484 075								
				KL	0 460 484 114								
			09.96-02.99	KL	0 460 484 115								
				KL	0 460 484 115								
		F8Q 624	01.97-02.99	KL	0 460 484 114								
				KL	0 460 484 115								
DTI [X64]	1,9	59	F9Q 744	01.01-10.02		0 460 414 983							
			69	F9Q 730	06.97-02.99		0 460 414 993	0 986 440 523					
		72	F9Q 731	03.99-10.02		0 460 414 988	0 986 440 520						
			F9Q 734	06.97-02.99		0 460 414 993	0 986 440 523						
		F9Q 736	03.99-10.02		0 460 414 988	0 986 440 520							
		<b>Megane I Classic</b>											
1.9 D [X64]	1,9	47-48	F8Q 620	09.96-09.96	CSA,KL	0 460 484 075							
					KL	0 460 484 074							
				10.96-04.97	KL	0 460 484 114							
					KL	0 460 484 115							





<b>1.9 D [X64]</b>	1,9	47-48	F8Q 624	09.96-09.03	KL	<b>0 460 484 114</b>	
			Mot.Nr. C011708→	06.97-09.03	KL,WEG	<b>0 460 484 133</b>	
			Mot.Nr. C011708→C024540	06.97-10.97	KL,WEG	<b>0 460 484 133</b>	
			Mot.Nr. C024541→	11.97-09.03	WEG	<b>0 460 484 136</b>	
			Mot.Nr. →C011707	09.96-05.97	KL	<b>0 460 484 117</b>	
					KL,WEG	<b>0 460 484 115</b>	
<b>DTI [X64]</b>	1,9	59	F9Q 744	11.00-09.03		<b>0 460 414 983</b>	
			72	F9Q 730	08.97-09.03		<b>0 460 414 993 0 986 440 523</b>
				F9Q 731	04.99-09.03		<b>0 460 414 988 0 986 440 520</b>
				F9Q 734	08.97-02.99		<b>0 460 414 993 0 986 440 523</b>
				F9Q 736	04.99-09.03		<b>0 460 414 988 0 986 440 520</b>
<b>Megane I Coupé</b>							
<b>1.9 DTI [X64]</b>	1,9	72	F9Q 731	03.99-10.02		<b>0 460 414 988 0 986 440 520</b>	
			F9Q 734	06.97-02.99		<b>0 460 414 993 0 986 440 523</b>	
			F9Q 736	03.99-10.02		<b>0 460 414 988 0 986 440 520</b>	
<b>Megane I Grandtour</b>							
<b>1.9 D [X64]</b>	1,9	59	F9Q 744	01.01-09.03		<b>0 460 414 983</b>	
<b>DTI [X64]</b>	1,9	72	F9Q 731; F9Q 736	07.98-09.03		<b>0 460 414 988 0 986 440 520</b>	
<b>Safrane</b>							
<b>2.1 D Turbo [B54]</b>	2,1	65-66	J8S 760	04.92-09.96	KL,WEG	<b>0 460 494 282</b>	
					KL,WEG	<b>0 460 494 380</b>	
					KL,WEG	<b>0 460 494 288</b>	
					KL,WEG	<b>0 460 494 379</b>	
<b>2.2 12V D Turbo [B54]</b>	2,2	83	G8T 740	10.96-12.00	KL	<b>0 460 494 440</b>	
					CSA,KL	<b>0 460 494 439</b>	
					GES,HEF	<b>0 460 494 451</b>	
					GES,HEF	<b>0 460 494 450</b>	
					KL	<b>0 460 494 426</b>	
					KL	<b>0 460 494 425</b>	
<b>2.5 D Turbo [B54]</b>	2,5	83-85	S8U 762,763 <8144 97 ..>	04.92-09.96	AG,WEG	<b>0 460 494 291</b>	
					AG,WEG	<b>0 460 494 420</b>	
					GS,WEG	<b>0 460 494 292</b>	
<b>Scenic I</b>							
<b>1.9 DTI [JA.]</b>	1,9	59	F9Q 744	11.00-04.03		<b>0 460 414 983</b>	
			72	F9Q 731	03.99-04.03		<b>0 460 414 988 0 986 440 520</b>
				F9Q 734	06.97-02.99		<b>0 460 414 993 0 986 440 523</b>
				F9Q 736	03.99-04.03		<b>0 460 414 988 0 986 440 520</b>
<b>5</b>							
<b>1.6 D</b>	1,6	40	F8M 720	10.84-09.87	BO	<b>0 460 494 105</b>	
			F8M 730	10.87-12.96	BO	<b>0 460 494 105</b>	
				01.89-12.96	BO	<b>0 460 484 030</b>	
<b>9</b>							
<b>1.6 D [L42]</b>	1,6	40	F8M 700; F8M 700,720; F8M 730	09.82-12.92	BO	<b>0 460 494 105</b>	
<b>11</b>							
<b>1.6 D</b>	1,6	40	F8M 700; F8M 720; F8M 730	03.83-03.91	BO	<b>0 460 494 105</b>	
<b>18 Berline</b>							
<b>2.1 D</b>	2,1	48-49	852 710, J8S	05.84-02.86		<b>0 460 494 145</b>	
<b>D Turbo</b>	2,1	65	J8S 712	04.84-02.86		<b>0 460 494 141</b>	
<b>18 Break</b>							
<b>2.1 D, D 4x2</b>	2,1	48-49	852 710, J8S	05.84-02.86		<b>0 460 494 145</b>	
<b>D Turbo</b>	2,1	65	J8S 712	04.84-02.86		<b>0 460 494 141</b>	
<b>19</b>							
<b>1.9 D [X53]</b>	1,9	47	F8Q 706	09.88-12.01	BO,KL	<b>0 460 484 043</b>	
					KL	<b>0 460 484 030</b>	
					BO,KL	<b>0 460 484 059</b>	
					BO,KL	<b>0 460 484 061</b>	
			F8Q 742	06.90-12.01	BO	<b>0 460 484 041</b>	
<b>19 Sedan</b>							
<b>1.9 D</b>	1,9	48	F8Q-756	01.94-11.01		<b>0 460 484 129</b>	





◀ RENAULT

<b>21</b>								
1.9 D	1,9	47	F8Q 706		01.93-12.00	<b>0 460 484 061</b>		
2.1 D [L48]	2,1	46-54	J8S 704		03.86-03.92 BO	<b>0 460 494 145</b>		
		46-56	J8S 600		04.92-12.94 <del>KL</del>	<b>0 460 494 324</b>		
						KL	<b>0 460 494 325</b>	
		49-54	J8S 784		04.92-12.94 <del>KL</del>	<b>0 460 494 299</b>		
						KL	<b>0 460 494 300</b>	
		53	J8S 740		05.89-08.89 <del>KL</del>	<b>0 460 494 228</b>		
						05.89-03.93 KL	<b>0 460 494 247</b>	
				09.89-03.93 <del>KL</del>	<b>0 460 494 251</b>			
D Turbo [L48]	2,1	65	J8S 714		03.86-03.93	<b>0 460 494 141</b>		
			J8S 742		03.86-03.93	<b>0 460 494 248</b>		
			J8S 746		05.89-05.91	<b>0 460 494 141</b>		
			J8S 786		06.91-12.94 <del>KL</del>	<b>0 460 494 297</b>		
						KL	<b>0 460 494 298</b>	
			J8S 788		06.90-03.92	<b>0 460 494 141</b>		
			65-68	J8S 604		04.92-12.94 <del>KL</del>	<b>0 460 494 326</b>	
						KL	<b>0 460 494 327</b>	
<b>21 Fastback</b>								
2.1 D [B48]	2,1	51-53	J8S 784		04.92-12.93 <del>KL</del>	<b>0 460 494 299</b>		
						KL	<b>0 460 494 300</b>	
			51-54	J8S 600		04.92-12.93 <del>KL</del>	<b>0 460 494 324</b>	
							KL	<b>0 460 494 325</b>
			53	J8S 740		09.89-12.93 <del>KL</del>	<b>0 460 494 251</b>	
							KL	<b>0 460 494 247</b>
D Turbo [B48]	2,1	65	J8S 704		09.89-03.92 BO	<b>0 460 494 145</b>		
			J8S 604		04.92-12.93 <del>KL</del>	<b>0 460 494 326</b>		
						KL	<b>0 460 494 327</b>	
			J8S 742		09.89-03.92 <del>KL</del>	<b>0 460 494 248</b>		
							KL	<b>0 460 494 249</b>
			J8S 746,714		09.89-03.92	<b>0 460 494 141</b>		
			J8S 786		06.91-12.93 <del>KL</del>	<b>0 460 494 297</b>		
			KL	<b>0 460 494 298</b>				
			J8S 788,714		06.90-03.92	<b>0 460 494 141</b>		
<b>21 Nevada</b>								
2.1 D [K48]	2,1	49	J8S 704		10.86-12.95 BO	<b>0 460 494 145</b>		
			51-54	J8S 600		04.92-12.95	<b>0 460 494 324</b>	
						KL	<b>0 460 494 325</b>	
			J8S 784		04.92-12.95	<b>0 460 494 299</b>		
						KL	<b>0 460 494 300</b>	
			53-54	J8S 740		05.89-11.89	<b>0 460 494 228</b>	
						05.89-12.95 KL	<b>0 460 494 247</b>	
						12.89-08.94	<b>0 460 494 251</b>	
D Turbo [K48]	2,1	65	J8S 604		04.92-12.95	<b>0 460 494 326</b>		
						KL	<b>0 460 494 327</b>	
			J8S 714		10.86-06.89	<b>0 460 494 141</b>		
			J8S 742		07.89-12.95	<b>0 460 494 248</b>		
						KL	<b>0 460 494 249</b>	
			J8S 746		05.89-12.95	<b>0 460 494 141</b>		
			J8S 786		06.91-12.95	<b>0 460 494 297</b>		
						KL	<b>0 460 494 298</b>	
			J8S 788		06.90-12.95	<b>0 460 494 141</b>		
<b>25</b>								
2.1 D	2,1	46	J8S 706		01.84-04.88	<b>0 460 494 145</b>		
			50-51	J8S 736		04.88-04.89	<b>0 460 494 228</b>	
						05.89-12.92	<b>0 460 494 251</b>	
D Turbo	2,1	63	J8S 708		01.84-09.89	<b>0 460 494 141</b>		
						KL	<b>0 460 494 156</b>	
						09.89-12.92 KL,LH	<b>0 460 494 249</b>	
						LH	<b>0 460 494 248</b>	
			J8S 738		06.89-12.92	<b>0 460 494 141</b>		





## ROVER

**Maestro**

2.0 D	2,0	46	Prima 65	09.88-12.93	<b>0 460 414 029</b>	
D Turbo	2,0	60	Prima-80T	07.89-08.90	<b>0 460 414 030</b>	
				09.90-04.92 BO	<b>0 460 414 082</b>	
				05.92-12.93 BO	<b>0 460 414 094</b>	

**Maestro Estate**

2.0 D	2,0	46	Prima 65	09.88-12.93	<b>0 460 414 029</b>	
D Turbo	2,0	60	Prima-80T	07.89-08.90	<b>0 460 414 030</b>	
				09.90-04.92 BO	<b>0 460 414 082</b>	
				05.92-12.93 BO	<b>0 460 414 094</b>	

**Montego**

2.0 D Turbo, D Turbo Estate	2,0	60	Prima-80T	09.88-08.90 BO	<b>0 460 414 030</b>	
				09.90-04.92 BO	<b>0 460 414 082</b>	
				05.92-12.93 BO	<b>0 460 414 094</b>	

**Serie 200**

220 SD	2,0	63	20 T2R <TCie-M>	09.95-03.00 BO	<b>0 460 414 118</b>	
SDI	2,0	77	20 T2N <TCie>			
			Fg.Nr. YD 471565→	09.95-03.00 BO,EDC	<b>0 470 004 005 0 986 444 503</b>	
			Fg.Nr. →YD 471564	09.95-03.00 BO,EDC	<b>0 460 414 992 0 986 440 522</b>	

**Serie 400**

418 TD	1,8	65	XUD7TE	09.91-02.96 BO	<b>0 460 484 019</b>	
420 SD	2,0	63	20 T2R <Serie-L>	10.95-03.00 BO	<b>0 460 414 118</b>	
SDI	2,0	77	20 T2N <Serie-L>			
			Fg.Nr. YD 471064→	10.95-03.00 BO,EDC	<b>0 470 004 005 0 986 444 503</b>	
			Fg.Nr. →YD 471063	10.95-03.00 BO,EDC	<b>0 460 414 992 0 986 440 522</b>	

**Serie 400 Tourer**

418 TD	1,8	65	XUD7TE	02.96-03.00 BO	<b>0 460 484 019</b>	
--------	-----	----	--------	----------------	----------------------	--

**Serie 600**

620 SDi	2,0	77	20 T2N <SERIE-L>			
			Fg.Nr. BM 246797→	03.95-12.98	<b>0 460 414 992 0 986 440 522</b>	
			Fg.Nr. →AM 246796	03.95-12.98	<b>0 460 414 995</b>	

**Serie 800**

825 TD	2,5	87	VM-425-SLIRR	10.91-12.98	<b>0 460 404 068</b>	
		88/92	VM-425-CLIER; VM-425-SLIER	01.96-12.98	<b>0 460 404 991</b>	

**25**

2.0 IDT	2,0	74/83	20 T2N <L-Serie>			
			Fg.Nr. YD 471565→	02.00-05.05 BO,EDC	<b>0 470 004 005 0 986 444 503</b>	
			Fg.Nr. →YD 471564	02.00-05.05 BO,EDC	<b>0 460 414 992 0 986 440 522</b>	

**45**

2.0 IDT	2,0	74/83	20 T2N <L-Serie>			
			Fg.Nr. YD 471064→	02.00-05.05 BO,EDC	<b>0 470 004 005 0 986 444 503</b>	
			Fg.Nr. →YD 471063	02.00-05.05 BO,EDC	<b>0 460 414 992 0 986 440 522</b>	

**2000-3500**

2400 D Turbo	2,4	67	VM-HR 492 HT	04.83-10.86	<b>0 460 404 034</b>	
--------------	-----	----	--------------	-------------	----------------------	--

## SAAB (SAAB AUTOMOBILE AB)

**9-3**

2.2 16V D Turbo [9400]	2,2	85/92	D223L <X 22 DTH>; D223L <Y 22 DTH>			
			Fg.Nr. →12020000	03.98-09.02	<b>0 470 504 004 0 986 444 003</b>	

**9-3 Coupé**

2.2 16V D Turbo [9400]	2,2	92	D223L <Y 22 DTH>			
			Fg.Nr. →12020000	11.00-09.02	<b>0 470 504 004 0 986 444 003</b>	

**9-5**

2.2 TiD [9600]	2,2	88	D223L	03.02-08.02 GS,THS	<b>0 470 504 208 0 986 444 046</b>	
----------------	-----	----	-------	--------------------	------------------------------------	--

**9-5 Kombi**

2.2 TiD [9600]	2,2	88	D223L	03.02-08.02 GS,THS	<b>0 470 504 208 0 986 444 046</b>	
----------------	-----	----	-------	--------------------	------------------------------------	--





**SEAT**

<b>Alhambra</b>									
1.9 TDI [7V8]	1,9	66	AHU		07.96-02.00			<b>0 460 404 971</b>	<b>0 986 440 555</b>
			1Z		03.96-07.96			<b>0 460 404 971</b>	<b>0 986 440 555</b>
		81	AFN		05.97-02.00			<b>0 460 404 968</b>	<b>0 986 440 567</b>
			AVG		09.97-02.00			<b>0 460 404 968</b>	<b>0 986 440 567</b>
<b>Arosa</b>									
1.7 SDI [6H1]	1,7	44	AKU		08.97-10.03			<b>0 460 404 967</b>	<b>0 986 440 553</b>
<b>Cordoba</b>									
1.9 D [6K2]	1,9	47-50	1Y		09.93-12.02	KL		<b>0 460 484 022</b>	<b>0 986 440 084</b>
								<b>0 460 484 035</b>	
		48	AGP		01.00→	KL		<b>0 460 484 127</b>	<b>0 986 440 240</b>
								<b>0 460 484 108</b>	
SDI [6K2]	1,9	47	AEY						
			Fg.Nr. →6K..V..247 164 →6K..W..021 847		12.95-09.97			<b>0 460 404 964</b>	<b>0 986 440 551</b>
			Fg.Nr. 6K..V..247 165 → Mot.Nr. 134 671		10.97-12.98			<b>0 460 404 966</b>	<b>0 986 440 552</b>
			Fg.Nr. 6K..W..021 848 →						
			Mot.Nr. 134 672 →		01.99-12.02			<b>0 460 404 961</b>	<b>0 986 440 570</b>
		50	AGP		05.99-08.02			<b>0 460 404 972</b>	<b>0 986 440 556</b>
SDI [6L2]	1,9	47	ASY		09.02-12.05			<b>0 460 404 972</b>	<b>0 986 440 556</b>
TD [6K2]	1,9	55	AAZ		09.93-08.97	KL		<b>0 460 494 294</b>	
			Mot.Nr. →367 001		09.93-08.97	KL		<b>0 460 484 058</b>	
			Mot.Nr. 367 012 →		09.93-08.97	KL		<b>0 460 494 346</b>	<b>0 986 440 249</b>
TDI [6K2]	1,9	66	AGR		05.99-12.02			<b>0 460 404 959</b>	<b>0 986 440 557</b>
					01.00→			<b>0 460 404 971</b>	<b>0 986 440 555</b>
					10.00→			<b>0 460 404 977</b>	<b>0 986 440 557</b>
			AHU		07.96-12.02			<b>0 460 404 971</b>	<b>0 986 440 555</b>
			1Z		07.96-12.96			<b>0 460 404 971</b>	<b>0 986 440 555</b>
		66/81	ALH; ASV		05.99-12.02			<b>0 460 404 959</b>	<b>0 986 440 557</b>
		81	AFN		03.97-12.02			<b>0 460 404 969</b>	<b>0 986 440 554</b>
<b>Cordoba Vario</b>									
1.9 SDI [6K5]	1,9	47	AEY						
			Fg.Nr. →6K..V..247 164 →6K..W..021 847		06.97-09.97			<b>0 460 404 964</b>	<b>0 986 440 551</b>
			Fg.Nr. 6K..V..247 165 → Mot.Nr. 134 671		10.97-12.98			<b>0 460 404 966</b>	<b>0 986 440 552</b>
			Fg.Nr. 6K..W..021 848 →						
			Mot.Nr. 134 672 →		01.99-06.99			<b>0 460 404 961</b>	<b>0 986 440 570</b>
		50	AGP		05.99-08.02			<b>0 460 404 972</b>	<b>0 986 440 556</b>
			AQM		06.99-09.00			<b>0 460 404 972</b>	<b>0 986 440 556</b>
TDI [6K5]	1,9	66	AGR		05.99-08.02			<b>0 460 404 959</b>	<b>0 986 440 557</b>
			AHU		06.97-06.99			<b>0 460 404 971</b>	<b>0 986 440 555</b>
			ALH		05.99-05.01			<b>0 460 404 959</b>	<b>0 986 440 557</b>
		81	AFN		02.98-06.99			<b>0 460 404 969</b>	<b>0 986 440 554</b>
			ASV		05.99-08.02			<b>0 460 404 959</b>	<b>0 986 440 557</b>
<b>Ibiza</b>									
1.7 D [Y..]	1,7	40	138 A 5..		06.84-07.88			<b>0 460 494 044</b>	
					08.88-02.90			<b>0 460 494 244</b>	
					03.90-05.93			<b>0 460 494 263</b>	
1.9 D [6K1]	1,9	47-50	1Y		03.93-10.99	KL		<b>0 460 484 022</b>	<b>0 986 440 084</b>
								<b>0 460 484 035</b>	
SDI [6K1]	1,9	47	AEY						
			Fg.Nr. →6K..V..247 164 →6K..W..021 847		12.95-09.97			<b>0 460 404 964</b>	<b>0 986 440 551</b>
			Fg.Nr. 6K..V..247 165 → Mot.Nr. 134 671		10.97-12.98			<b>0 460 404 966</b>	<b>0 986 440 552</b>
			Fg.Nr. 6K..W..021 848 →						
			Mot.Nr. 134 672 →		01.99-10.99			<b>0 460 404 961</b>	<b>0 986 440 570</b>
		50	AGP		05.99-05.02			<b>0 460 404 972</b>	<b>0 986 440 556</b>
			AQM		05.99-05.02			<b>0 460 404 972</b>	<b>0 986 440 556</b>
SDI [6L1]	1,9	47	ASY		01.02-12.05			<b>0 460 404 972</b>	<b>0 986 440 556</b>
TD [6K1]	1,9	55	AAZ		03.93-08.97	KL		<b>0 460 494 346</b>	<b>0 986 440 249</b>
								<b>0 460 494 294</b>	





1.9 TDI [6K1]	1,9	66	AGR	05.99-05.02		0 460 404 959	0 986 440 557
			AHU	12.96-06.99		0 460 404 971	0 986 440 555
			ALH	05.99-05.02		0 460 404 959	0 986 440 557
			1Z	07.96-12.96		0 460 404 971	0 986 440 555
			81 AFN	03.97-06.99		0 460 404 969	0 986 440 554
			ASV	05.99-05.02		0 460 404 959	0 986 440 557

**Inca**

1.7 D [6K9]	1,7	42	AHB				
			Mot.Nr. →005 980	09.96-09.00		0 460 404 967	0 986 440 553

1.9 D	1,9	47	AEY	05.99→	KL	0 460 484 127	0 986 440 240
					KL	0 460 484 128	0 986 440 241

D [6K9]	1,9	47	1Y	11.95-06.03	KL	0 460 484 128	0 986 440 241
---------	-----	----	----	-------------	----	---------------	---------------

SDI [6K9]	1,9	47	AEY				
			Fg.Nr. →9K..W..003 000	12.95-09.97		0 460 404 964	0 986 440 551
			Fg.Nr. 9K..W..003 001→9K..X..015 600	10.97-12.98		0 460 404 966	0 986 440 552
			AYQ	09.00-06.03		0 460 404 959	0 986 440 557

**Leon**

1.9 SDI [1M1]	1,9	50	AQM	12.99-10.03		0 460 404 972	0 986 440 556
TDI [1M1]	1,9	66/81	AGR; AHF; ALH	10.98-07.04		0 460 404 959	0 986 440 557
		81	ASV	10.99-10.05		0 460 404 959	0 986 440 557

**Malaga**

1.7 D	1,7	40	138 A 5..	05.85-07.88		0 460 494 044	
				08.88-02.90		0 460 494 244	
				03.90-12.93		0 460 494 263	

**Ronda**

1.7 D	1,7	40	138 A 5..	06.82-12.86		0 460 494 044	
-------	-----	----	-----------	-------------	--	---------------	--

**Terra**

1.4 D	1,4	35		10.90-12.94		0 460 484 033	0 986 440 238
-------	-----	----	--	-------------	--	---------------	---------------

**Toledo**

1.9 D [1L2]	1,9	47	1Y	05.91-03.99	MKO	0 460 484 035		
					MLK	0 460 484 128	0 986 440 241	
				Fg.Nr. →1L..TR 020 000	05.91-12.95	KL	0 460 484 022	0 986 440 084
			Fg.Nr. 1L..TR 020 001→	01.96-03.99	KL	0 460 484 127	0 986 440 240	
TD [1L2]	1,9	55	AAZ	05.91-04.97	CH	0 460 494 314	0 986 440 142	
				Fg.Nr. 1L..TR006 423→	05.91-04.97	KL	0 460 494 445	0 986 440 251
				Fg.Nr. 1L..ZD241 134→1L..TR006 422	05.91-04.97	KL	0 460 494 294	
				Mot.Nr. AAZ 363 385→AAZ 367 011	05.91-04.97	KL	0 460 494 286	0 986 440 247
				Mot.Nr. AAZ 367 012→Fg.Nr. 1L..ZD241 133	05.91-04.97	KL	0 460 494 285	
				Mot.Nr. →AAZ 363 384	05.91-04.97	KL	0 460 494 277	
TDI [1L2]	1,9	66	AHU	06.96-03.99		0 460 404 971	0 986 440 555	
			1Z	04.95-12.96		0 460 404 971	0 986 440 555	
			81 AFN	11.96-03.99			0 986 440 554	
TDI [1M2]	1,9	66/81	AGR; AHF; ALH; ASV	04.99-07.04		0 460 404 959	0 986 440 557	

SKODA

**Fabia**

1.9 SDI [6Y3]	1,9	47	ASY	09.99-12.07		0 460 404 972	0 986 440 556
---------------	-----	----	-----	-------------	--	---------------	---------------

**Fabia Combi**

1.9 SDI [6Y5]	1,9	47	ASY	08.00-12.07		0 460 404 972	0 986 440 556
---------------	-----	----	-----	-------------	--	---------------	---------------

**Fabia Schrägheck**

1.9 SDI [6Y2]	1,9	47	ASY	09.99-03.08		0 460 404 972	0 986 440 556
---------------	-----	----	-----	-------------	--	---------------	---------------

**Octavia**

1.9 SDI [1U2]	1,9	50	AGP	05.97-07.00		0 460 404 972	0 986 440 556	
			AQM	08.00-12.03		0 460 404 972	0 986 440 556	
TDI [1U2]	1,9	66	ALH	08.00-03.10	AG		0 986 440 519	
					GS	0 460 404 959	0 986 440 557	
			66/81	AGR; AHF	09.96-12.09		0 460 404 959	0 986 440 557
			81	ASV	08.00-01.06		0 460 404 959	0 986 440 557



◀ SKODA

Octavia Combi							
1.9 SDI [1U5]	1,9	50	AGP		05.97-07.00	0 460 404 972	0 986 440 556
			AQM		08.00-12.03	0 460 404 972	0 986 440 556
TDI [1U5]	1,9	66	ALH		08.00-03.10 AG		0 986 440 519
							0 986 440 561
		81	ASV		08.00-01.06	0 460 404 959	0 986 440 557
TDI, TDI 4x4 [1U5]	1,9	66/81	AGR; AHF		08.97-12.09	0 460 404 959	0 986 440 557
Superb							
2.5 TDI [3U4]	2,5	120	BDG		06.03-03.08 THI	0 470 506 038	0 986 444 083

**TAGAZ**

Tager							
2.9 D	2,9	110	662 LA <Euro 3>		04.08→	0 460 495 003	

**TALBOT**

Horizon							
1.9 D	1,9	47-48	XUD9		10.83-06.86 BO	0 460 494 153	

**TATA (TELCO)**

Safari							
2.0 D Turbo, D Turbo 4x4	2,0	66	483 DL		02.98→	BKN 0 460 494 422	KSE 0 460 494 418
Sierra							
1.9 D	1,9	44-50	483 DL		11.89-06.95	9 460 034 410	
					07.95-06.98	9 460 034 413	
D Turbo	1,9	66	483 DL TCIC		06.97-05.02	BKN 0 460 494 422	KSE 0 460 494 418
Sumo							
1.9 D	1,9	50	483 DL		05.94-06.95	9 460 034 410	
					07.95-07.00	9 460 034 413	
					08.00→	EU3 0 460 494 481	
					05.05→	EU3 0 460 494 489	
D Turbo	1,9	66	483 DL TCIC		04.00→	BOK 0 460 494 418	KZO 0 460 494 422
D Turbo 4x4	1,9	66	483 DL TCIC		01.98→	BKN 0 460 494 422	KSE 0 460 494 418
Tatamobile							
2.0 D	1,9	44-50	483 DL		06.89-06.95	9 460 034 410	
					07.95-07.00	9 460 034 413	
Telcoline							
2.0 TDi	2,0	64			10.03→	BOK 0 460 494 418	

**UAZ**

Hunter							
2.2 D 4x4	2,2	72	5143.1 <Euro 2>		01.06→	0 460 414 217	







## VAUXHALL

## Astra

1.7 D [E]	1,7	42	17 D/DR <OHC>	01.89-08.91	AG	<b>0 460 494 230</b>	
					CSA	<b>0 460 494 229</b>	
D/DR [F]	1,7	42-44	17 D/DR <OHC>				
			Mot.Nr. →14363651	12.91-02.98		<b>0 460 494 293</b>	
			Mot.Nr. 14363652→	12.91-02.98		<b>0 460 494 330</b>	<b>0 986 440 143</b>
DT [G]	1,7	50	X 17 DTL <Turbo>	03.98-08.00		<b>0 470 004 003</b>	<b>0 986 444 500</b>
DTL [F]	1,7	50	X 17 DTL <OHC>	07.95-02.98	WEG	<b>0 460 494 353</b>	<b>0 986 440 150</b>
					WEG	<b>0 460 494 372</b>	<b>0 986 440 152</b>
TD [F]	1,7	60	17 DT/TC4 <EE1 OHC>	12.91-02.98	DKF, KL,	<b>9 460 620 011</b>	
					WEG		
					DKF, KL,	<b>9 460 620 013</b>	
					WEG		
					DKF, KL,	<b>9 460 620 020</b>	
					WEG		
			Mot.Nr. →076350	12.91-02.98	DKF, KL,	<b>9 460 620 017</b>	<b>9 460 620 017</b>
					WEG		
			Mot.Nr. 076351→	12.91-02.98	DKF, KL,	<b>9 460 620 021</b>	
					WEG		
2.0 DTI [G]	2,0	74	Y 20 DTH <Turbo>				
			Mot.Nr. 32000001→35000001→36000001→	09.00-08.05	THS	<b>0 470 504 210</b>	<b>0 986 444 029</b>
			38000001→3B000001→H0000001→				
DTL [G]	2,0	60	X 20 DTL <Turbo>	03.98-08.00	NC8	<b>0 470 504 003</b>	<b>0 986 444 002</b>
			Y 20 DTL <Turbo>	09.00-08.05	NC8	<b>0 470 504 003</b>	<b>0 986 444 002</b>
2.2 DTI [G]	2,2	92	Y 22 DTR <Turbo>	09.01-08.05	THS	<b>0 470 504 209</b>	<b>0 986 444 028</b>

## Astra Estate

1.7 D/DR [F]	1,7	42-44	17 D/DR <OHC>				
			Mot.Nr. →14363651	12.91-02.98		<b>0 460 494 293</b>	
			Mot.Nr. 14363652→	12.91-02.98		<b>0 460 494 330</b>	<b>0 986 440 143</b>
DT [G]	1,7	50	X 17 DTL <Turbo>	03.98-08.00		<b>0 470 004 003</b>	<b>0 986 444 500</b>
DTL [F]	1,7	50	X 17 DTL <OHC>	07.95-02.98	WEG	<b>0 460 494 353</b>	<b>0 986 440 150</b>
					WEG	<b>0 460 494 372</b>	<b>0 986 440 152</b>
TD [F]	1,7	60	17 DT <TC4EE1>	12.91-02.98	DKF, KL,	<b>9 460 620 011</b>	
					WEG		
					DKF, KL,	<b>9 460 620 013</b>	
					WEG		
					DKF, KL,	<b>9 460 620 020</b>	
					WEG		
			Mot.Nr. →076350	12.91-02.98	DKF, KL,	<b>9 460 620 017</b>	<b>9 460 620 017</b>
					WEG		
			Mot.Nr. 076351→	12.91-02.98	DKF, KL,	<b>9 460 620 021</b>	
					WEG		
2.0 DTI [G]	2,0	74	Y 20 DTH <Turbo>				
			Mot.Nr. 32000001→35000001→36000001→	09.00-08.05	THS	<b>0 470 504 210</b>	<b>0 986 444 029</b>
			38000001→3B000001→H0000001→				
DTL [G]	2,0	60	X 20 DTL <Turbo>	03.98-08.00	NC8	<b>0 470 504 003</b>	<b>0 986 444 002</b>
			Y 20 DTL <Turbo>	09.00-08.05	NC8	<b>0 470 504 003</b>	<b>0 986 444 002</b>

## Astra Van

1.7 D/DR [F]	1,7	42-44	17 D/DR <OHC>				
			Mot.Nr. →14363651	12.91-02.98		<b>0 460 494 293</b>	
			Mot.Nr. 14363652→	12.91-02.98		<b>0 460 494 330</b>	<b>0 986 440 143</b>
DT [G]	1,7	50	X 17 DTL <Turbo>	03.98-08.00		<b>0 470 004 003</b>	<b>0 986 444 500</b>
DTL [F]	1,7	50	X 17 DTL <OHC>	07.95-02.98	WEG	<b>0 460 494 353</b>	<b>0 986 440 150</b>
					WEG	<b>0 460 494 372</b>	<b>0 986 440 152</b>
2.0 DTI [G]	2,0	74	Y 20 DTH <Turbo>				
			Mot.Nr. 32000001→35000001→36000001→	09.00-08.05	THS	<b>0 470 504 210</b>	<b>0 986 444 029</b>
			38000001→3B000001→H0000001→				
DTL [G]	2,0	60	X 20 DTL <Turbo>	03.98-08.00	NC8	<b>0 470 504 003</b>	<b>0 986 444 002</b>





◀ VAUXHALL

Brava Pick-Up											
2.2 D [TFO]	2,2	39	4 FD1	06.90-09.96	DKF	9 460 610 332					
2.5 D [TFO]	2,5	56-74	4 JA1	06.90-09.92	DKF	9 460 610 377					
					DKF,DRE	9 460 610 378					
				10.92-06.94	DKF	9 460 610 603					
					DKF,DRE	9 460 610 604					
TD [TFO]	2,5	56	4 JA1 T	10.89-12.96	DKF,EFV	9 460 611 449					
3.1 TD [TFO]	3,1	80	4 JG2 T	03.95-12.96	DKF	9 460 610 963					
Carlton II											
2.3 D	2,3	52/63	23 D	05.83-08.86		0 460 494 127					
Carlton III											
2.3 D	2,3	54	23 YD		Mot.Nr. →00173158	09.86-10.94	GS	0 460 494 197			
					Mot.Nr. 00173159→	09.86-10.94	AG	0 460 494 231			
					Mot.Nr. 00173159→01194897	09.86-10.94	GS	0 460 494 232			
					Mot.Nr. 01194898→	09.86-10.94	GS	0 460 494 316			
					TD Interc.	2,3	74	23 DTR	09.88-10.94	AGR,GS	0 460 404 056
					GS,KAT	0 460 404 074 0 986 440 002					
			Fg.Nr. K1000099→	09.88-10.94	AG	0 460 404 057					
					EEC,GS, LLE	0 460 404 055					
					EEC,GS, RLE	0 460 404 071					
			Fg.Nr. →K1000098	09.88-10.94	AG	0 460 404 048					
					GS	0 460 404 037					
YTD	2,3	66	23 YDT	09.86-09.88	AGR,GS	0 460 404 056					
					GS,KAT	0 460 404 074 0 986 440 002					
			Fg.Nr. K1000099→	09.86-09.88	AG	0 460 404 057					
					EEC,GS, LLE	0 460 404 055					
					EEC,GS, RLE	0 460 404 071					
			Fg.Nr. →K1000098	09.86-09.88	AG	0 460 404 048					
					GS	0 460 404 037					
Cavalier III											
1.7 D	1,7	42	17 D/DR		Fg.Nr. NV100001→N1000001→N5000001→	09.88-11.95		0 460 494 293			
					Fg.Nr. →MV999999 →M1999999 →M5999999	09.88-11.95	CSA	0 460 494 229			
TD	1,7	60	17 DT/TC4 EE1		Fg.Nr. R1000001→R5000001→R7500001→	09.88-11.95	DKF,WEG	9 460 620 011			
							DKF,WEG	9 460 620 017 9 460 620 017			
					Fg.Nr. →P1999999 →P5999999 →P7599999	09.88-11.95	DKF,WEG	9 460 620 007 9 460 620 007			
Combo											
1.7 D	1,7	44	X 17 D 4EE1; 17 D <4EE1>		Mot.Nr. →076351	09.94-10.01	DKF,WEG	9 460 620 010 9 460 620 010			
					Mot.Nr. 076352→092141	09.94-10.01	DKF,WEG	9 460 620 019			
					Mot.Nr. 092142→	09.94-10.01	DKF,WEG	9 460 620 023			
					Mot.Nr. 877698→076351	09.94-10.01	DKF,WEG	9 460 620 016			
Corsa											
1.5 D [B]	1,5	37	X 15 D <4EC1 OHC>		Mot.Nr. →877695	04.96-08.00	DKF,WEG	9 460 620 008 9 460 620 008			
					Mot.Nr. 877696→	04.96-08.00	DKF,WEG	9 460 620 014			
			15 D <4EC1>		Mot.Nr. →877695	09.94-08.00	DKF,WEG	9 460 620 008 9 460 620 008			
					Mot.Nr. 877696→	09.94-08.00	DKF,WEG	9 460 620 014			
					TD [B]	1,5	49	15 TD <T4EC1 Turbo>	09.94-08.00	DKF,WEG	9 460 620 009 9 460 620 009
								Mot.Nr. 00877708→	09.94-08.00	DKF,WEG	9 460 620 015 9 460 620 015
XTD [B]	1,5	49	X 15 TD <4EE1 Turbo>		Mot.Nr. 00877708→	04.96-08.00	DKF,WEG	9 460 620 009 9 460 620 009			
							DKF,WEG	9 460 620 015 9 460 620 015			





<b>1.7 D [B]</b>	1,7	44	X 17 D 4EE1; 17 D <4EE1>					
			Mot.Nr. →076351	09.94-08.00	DKF,WEG	<b>9 460 620 010</b>	<b>9 460 620 010</b>	
			Mot.Nr. 076352→092141	09.94-08.00	DKF,WEG	<b>9 460 620 019</b>		
			Mot.Nr. 092142→	09.94-08.00	DKF,WEG	<b>9 460 620 023</b>		
			Mot.Nr. 877698→076351	09.94-08.00	DKF,WEG	<b>9 460 620 016</b>		
<b>Frontera</b>								
<b>2.2 DTI [B]</b>	2,2	85/88	X 22 DTH <Turbo>; Y 22 DTH <Turbo>	09.98-09.04		<b>0 470 504 009</b>	<b>0 986 444 005</b>	
<b>2.3 TD [A]</b>	2,3	74	23 DT <Turbo>	01.92-08.95		<b>0 460 404 056</b>		
					GS,KAT	<b>0 460 404 074</b>	<b>0 986 440 002</b>	
<b>2.5 TDS Turbo [A]</b>	2,5	85	VM41B <Venturi-25TD>	06.96-08.98		<b>0 460 404 991</b>		
<b>2.8 TDI Turbo [A]</b>	2,8	83	4JB1T	02.95-08.98	DKF,WEG	<b>9 460 611 452</b>		
			Fg.Nr. →SV799999	02.95-08.98	DKF,WEG	<b>9 460 610 708</b>		
<b>Monterey</b>								
<b>3.1 TD [A]</b>	3,1	84	4 JG2 TC OHV	09.93-07.96	WEG	<b>9 460 610 626</b>		
				05.95-07.96	WEG	<b>9 460 610 950</b>		
				07.95-07.96	FHE	<b>9 460 610 951</b>		
					FHE,WEG	<b>9 460 610 952</b>		
				08.96-08.98	WEG	<b>9 460 611 262</b>		
					KL,WEG	<b>9 460 611 263</b>		
					OWK,WEG	<b>9 460 611 100</b>		
					OWO	<b>9 460 611 099</b>		
				CH 09.91-12.91		<b>9 460 610 657</b>		
				CH 09.91-12.91		<b>9 460 610 656</b>		
			Fg.Nr. AB/JC→AI/JC	CH 01.92-08.92		<b>9 460 610 596</b>	<b>9 460 610 596</b>	
			Fg.Nr. AC/JC→AI/JD	CH 01.92-08.93		<b>9 460 610 544</b>		
			Fg.Nr. AJ/JC→AI/JD	CH 09.92-08.93		<b>9 460 610 609</b>		
<b>Nova</b>								
<b>1.5 D</b>	1,5	37	15 D/4EC1-AAD <OHC>	09.87-08.94	DKF,TW	<b>9 460 620 001</b>		
TD	1,5	49	15 DT/T4EC1-AADT <OHC>	01.90-08.94	DKF,TW	<b>9 460 620 002</b>		
<b>Omega</b>								
<b>2.0 DTI [B]</b>	2,0	74	X 20 DTH Turbo	09.97-08.00	NC8	<b>0 470 504 009</b>	<b>0 986 444 005</b>	
					NT5	<b>0 470 504 011</b>	<b>0 986 444 012</b>	
<b>2.2 DTI [B]</b>	2,2	88	Y 22 DTH <Turbo>	06.00-09.03	NC9	<b>0 470 504 016</b>	<b>0 986 444 021</b>	
<b>2.5 TD, TDI [B]</b>	2,5	96	U 25 TD <R6 Turbo>; X 25 TD <Turbo>	04.94-09.04		<b>0 460 406 994</b>	<b>0 986 440 516</b>	
<b>Signum</b>								
<b>2.0 DTI</b>	2,0	74	Y 20 DTH <Ecotec>	05.03-09.05	THS	<b>0 470 504 217</b>	<b>0 986 444 030</b>	
<b>2.2 DTI</b>	2,2	86-92	Y 22 DTR <Ecotec>	05.03-09.08	THS	<b>0 470 504 217</b>	<b>0 986 444 030</b>	
<b>Sintra</b>								
<b>2.2 TD</b>	2,2	85	X 22 DTH <Turbo>	09.97-07.99		<b>0 470 504 009</b>	<b>0 986 444 005</b>	
<b>Vectra</b>								
<b>1.7 TD [B]</b>	1,7	60	X 17 TD <TC4 EE1 Turbo>	09.95-08.01	DKF,KL, WEG	<b>9 460 620 011</b>		
					DKF,KL, WEG	<b>9 460 620 013</b>		
					DKF,KL, WEG	<b>9 460 620 020</b>		
			Mot.Nr. →076356	09.95-08.01	DKF,KL, WEG	<b>9 460 620 017</b>	<b>9 460 620 017</b>	
			Mot.Nr. 076357→	09.95-08.01	DKF,KL, WEG	<b>9 460 620 021</b>		
<b>2.0 DI [B]</b>	2,0	60	X 20 DTL <Ecotec 16V Turbo>	09.96-08.00	NT5	<b>0 470 504 011</b>	<b>0 986 444 012</b>	
					TW	<b>0 470 504 002</b>	<b>0 986 444 001</b>	
						<b>0 470 504 003</b>	<b>0 986 444 002</b>	
DTI [B]	2,0	74	X 20 DTH <16V Turbo>	09.97-02.98	NC8	<b>0 470 504 004</b>	<b>0 986 444 003</b>	
				09.97-08.00	NT5	<b>0 470 504 011</b>	<b>0 986 444 012</b>	
			Y 20 DTH <16V Turbo>	09.00-08.01		<b>0 470 504 015</b>	<b>0 986 444 014</b>	
DTI [C]	2,0	74	Y 20 DTH <Turbo Ecotec>	04.02-09.05	THS	<b>0 470 504 210</b>	<b>0 986 444 029</b>	
<b>2.2 DTI [B]</b>	2,2	92	Y 22 DTR <Turbo>	09.00-08.01		<b>0 470 504 016</b>	<b>0 986 444 021</b>	
DTI [C]	2,2	86-92	Y 22 DTR <Turbo Ecotec>	04.02-09.05	THS	<b>0 470 504 209</b>	<b>0 986 444 028</b>	





◀ VAUXHALL

Vectra Estate						
1.7 TD [B]	1,7	60	X 17 TD <TC4 EE1 Turbo>	09.95-08.01	DKF, KL, WEG	9 460 620 011
					DKF, KL, WEG	9 460 620 013
					DKF, KL, WEG	9 460 620 020
			Mot.Nr. →076356	09.95-08.01	DKF, KL, WEG	9 460 620 017 9 460 620 017
			Mot.Nr. 076357→	09.95-08.01	DKF, KL, WEG	9 460 620 021
2.0 DI [B]	2,0	60	X 20 DTL <Ecotec 16V Turbo>	09.96-08.00	NT5	0 470 504 011 0 986 444 012
					TW	0 470 504 002 0 986 444 001
						0 470 504 003 0 986 444 002
DTI [B]	2,0	74	X 20 DTH <16V Turbo>	09.97-02.98	NC8	0 470 504 004 0 986 444 003
				09.97-08.00	NT5	0 470 504 011 0 986 444 012
			Y 20 DTH <16V Turbo>	09.00-08.01		0 470 504 015 0 986 444 014
DTI [C]	2,0	74	Y 20 DTH <Turbo Ecotec>	09.03-09.05	THS	0 470 504 210 0 986 444 029
2.2 DTI [B]	2,2	92	Y 22 DTR <Turbo>	09.00-08.01		0 470 504 016 0 986 444 021
DTI [C]	2,2	86-92	Y 22 DTR <Ecotec>	09.03-09.05	THS	0 470 504 209 0 986 444 028
Zafira						
2.0 DI [A]	2,0	60	X 20 DTL <Turbo Ecotec>	03.99-08.00	NC8	0 470 504 003 0 986 444 002
DTI [A]	2,0	74	Y 20 DTH <Turbo Ecotec>			
			Fg.Nr. →22999999	04.99-06.05		0 470 504 015 0 986 444 014
					THS	0 470 504 218 0 986 444 036
			Fg.Nr. 32000001→ 35000001→ 36000001→ 38000001→ 3H000001→	04.99-06.05	AG, THS	0 470 504 217 0 986 444 030
					GS, THS	0 470 504 218 0 986 444 036
2.2 DTI [A]	2,2	92	Y 22 DTR <Turbo Ecotec>			
			Fg.Nr. →22999999 →25999999 →26999999 →28999999 →2H999999	03.02-06.05	THS	0 470 504 209 0 986 444 028
			Fg.Nr. 32000001→ 35000001→ 36000001→ 38000001→ 3H000001→	03.02-06.05	THS	0 470 504 219 0 986 444 037

**VOLVO**

S40 I						
1.9 D	1,9	70	D4192T2	03.98-07.00		0 460 414 984
S70						
2.5 TDI	2,5	103	D5252T	01.97-07.00		0 460 415 990 0 986 440 564
S80 I						
2.5 TDI	2,5	103	D5252T	08.98-07.01		0 460 415 990 0 986 440 564
V40						
1.9 D	1,9	70	D4192T2	08.98-07.00		0 460 414 984
V70 I						
2.5 TDI	2,5	103	D5252T	01.97-03.00		0 460 415 990 0 986 440 564
V70 II						
2.5 D	2,5	103	D5252T	03.00-07.01		0 460 415 990 0 986 440 564
240						
2.4 D	2,4	58-60	D24	08.83-07.93		0 460 406 037
					AG	0 460 406 038
740						
2.4 D	2,4	60	D24	04.84-07.92		0 460 406 037
					AG	0 460 406 038
TD	2,4	80	D24T	04.85-07.87		0 460 406 019
				08.87-07.92		0 460 406 054
		85	D24TIC	08.87-07.92		0 460 406 077
760						
2.4 D	2,4	60	D24	01.82-07.87	AG	0 460 406 019
					GS	0 460 406 018
TD	2,4	79	D24T	08.84-07.87	AG	0 460 406 044
		80	D24T	08.82-07.87	AG	0 460 406 019
					GS	0 460 406 018



2.4 TD	2,4	85	D24TIC	08.87-07.92		0 460 406 077	
					AG	0 460 406 019	
<b>850</b>							
TDI	2,5	103	D5252T	05.96-07.97		0 460 415 990	0 986 440 564
<b>850 Kombi</b>							
TDI	2,5	103	D5252T	05.96-07.97		0 460 415 990	0 986 440 564
<b>940</b>							
2.4 TD	2,4	80/90	D24T; D24TIC				
			Fg.Nr. →65355	09.90-07.97	KOB	0 460 406 054	
			Fg.Nr. →112962	09.90-07.97		0 460 406 054	
			Fg.Nr. 65356→	09.90-07.97	KOB	0 460 406 077	
			Fg.Nr. 112963→	09.90-07.97		0 460 406 077	
<b>960</b>							
2.4 TD	2,4	85	D24TIC				
			Fg.Nr. →11622	08.90-07.97	KOB	0 460 406 054	
			Fg.Nr. →30003	08.90-07.97		0 460 406 054	
			Fg.Nr. 11623→	08.90-07.97	KOB	0 460 406 077	
			Fg.Nr. 30004→	08.90-07.97		0 460 406 077	

**VW (VOLKSWAGEN)**

<b>Bora</b>							
1.9 SDI [1J2]	1,9	50	AGP	09.98-04.01		0 460 404 972	0 986 440 556
			AQM	09.98-05.05		0 460 404 972	0 986 440 556
TDI [1J2]	1,9	66	ALH	09.98-04.02	GS	0 460 404 977	0 986 440 557
				05.02-05.05	GS	0 460 404 959	0 986 440 557
		81	ASV	05.00-04.02		0 460 404 977	0 986 440 557
				05.02-05.05		0 460 404 959	0 986 440 557
TDI, TDI 4 Motion [1J2]	1,9	66/81	AGR; AHF	09.98-04.02		0 460 404 977	0 986 440 557
				05.02-05.05		0 460 404 959	0 986 440 557
<b>Bora Variant</b>							
1.9 TDI [1J6]	1,9	66/81	AGR; AHF; ASV	09.98-04.02		0 460 404 977	0 986 440 557
				05.02-05.05		0 460 404 959	0 986 440 557
<b>Caddy</b>							
1.7 SDI [9K9]	1,7	42	AHB				
			Mot.Nr. →005 980	07.96-04.98		0 460 404 967	0 986 440 553
			Mot.Nr. 005 981→	05.98-09.00		0 460 404 962	
1.9 D [9K9]	1,9	47	1Y	11.95-06.03	MLK	0 460 484 128	0 986 440 241
					OLK	0 460 484 071	0 986 440 240
SDI [9K9]	1,9	47	AEY				
			Fg.Nr. →9K..W..516 000	11.95-09.97		0 460 404 964	0 986 440 551
			Fg.Nr. 9K..W..516 001→9K..W..529 222	10.97-01.98		0 460 404 966	0 986 440 552
			Fg.Nr. 9K..W..529 223→	02.98-09.00		0 460 404 961	0 986 440 570
SDI, TDI [9K9]	1,9	47/66	ALH; AYQ	09.00-06.03		0 460 404 977	0 986 440 557
TDI [9K9]	1,9	66	AHU	12.96-09.00		0 460 404 971	0 986 440 555
			ALE	09.97-09.00		0 460 404 970	0 986 440 568
			1Z	10.96-03.97		0 460 404 971	0 986 440 555
<b>Caddy Pickup</b>							
1.6 D [14, 1A]	1,6	40	JK	A 08.83-07.90		0 460 494 183	
			Fg.Nr. 14-E-000001→14-L-012000	08.83-07.90	TW	0 460 494 131	
			Fg.Nr. 14-G-000001→14-K-001739	D 08.85-10.88	AGF	0 460 494 179	
			ME	08.90-07.92		0 460 494 269	
<b>Golf</b>							
1.6 D [1G1]	1,6	40	ME	12.88-12.91		0 460 494 210	
D [19]	1,6	38	ME				
			Fg.Nr. ME 520001→	08.85-07.88		0 460 494 185	
<b>Golf I Bakkie</b>							
1.6 D [15, 16]	1,6	40	JK	06.81-12.87	TW	0 460 494 131	





◀ VW

Golf II							
1.6 D [19, 1G]	1,6	40	JP	⊘	08.83-10.91	AG	0 460 494 140
						GS,TW	0 460 494 131
					Fg.Nr. →1G..KW400 000 →1G..KB090 000	D 08.83-01.89	0 460 494 179
					Fg.Nr. 1G..KW400 001 → 1G..KB090 001 →	D 02.89-10.91	0 460 494 241
			ME			CH 09.85-08.92	0 460 494 200
						CH 09.85-08.92	0 460 494 210
TD [19, 1G]	1,6	44	1V		08.89-07.92	CSA	0 460 484 027
		51	JR		D 08.83-10.91		0 460 494 182 0 986 440 125
					⊘ 08.83-10.91		0 460 494 138
			MF		08.88-10.91		0 460 494 182 0 986 440 125
		59	RA		04.89-02.90		0 460 494 239
			SB		08.89-10.91		0 460 494 267 0 986 440 135

Golf III							
1.9 D [1H1]	1,9	47	1Y		Fg.Nr. →1H..S..120 000 →1H..SB060 000	11.91-08.94	0 460 484 046 0 986 440 239
						ECO	0 460 484 069
					Fg.Nr. 1H..S..120 001 → 1H..SB060 001 →	09.94-12.97	0 460 484 127 0 986 440 240
						ECO	0 460 484 077
SDI [1H1]	1,9	47	AEY			01.95-12.97	0 460 404 964 0 986 440 551
TD [1H1]	1,9	55	AAZ		Fg.Nr. →1H..P..990 000	A,FIN, 11.91-07.93	0 460 494 306
						N,S	
					Fg.Nr. →1H..RW160 000 →1H..RB040 000	A,FIN, 11.91-08.93	0 460 494 286 0 986 440 247
						N,S	
					Fg.Nr. →1H..S..120 000 →1H..SB060 000	CH 11.91-08.94	0 460 494 314 0 986 440 142
						A,FIN, 11.91-08.94	0 460 494 294
						N,S	
					Fg.Nr. 1H..RW160 001 →1H..S..120 000 1H..RB040 001 →1H..SB060 000	A,FIN, 09.93-08.94	0 460 494 346 0 986 440 249
						N,S	
					Fg.Nr. 1H..R..000 001 →1H..S..120 000 →1H..SB060 000	A,FIN, 08.93-08.94	0 460 494 347
						N,S	
					Fg.Nr. 1H..S..120 001 → 1H..SB060 001 →	A,FIN, 09.94-12.97	0 460 494 362
						N,S	
						CH 09.94-12.97	0 460 494 414
						A,FIN, 09.94-12.97	0 460 494 444 0 986 440 250
						N,S	KL 0 460 494 445 0 986 440 251
TD [1H1/1W1]	1,9	55	AAZ		Fg.Nr. →1H-R-045 250	10.92-11.93	0 460 494 306
					Fg.Nr. →1H-S-069 870	10.92-12.94	0 460 494 294
					Fg.Nr. 1H-R-045 251 →1H-S-048 650	11.93-10.94	0 460 494 347
					Fg.Nr. 1H-S-048 651 →	10.94-07.98	0 460 494 362
TDI [1H1]	1,9	66	1Z			09.93-07.96	0 460 404 971 0 986 440 555
		81	AFN			03.96-12.97	0 460 404 969 0 986 440 554
TDI [1H1/1W1]	1,9	66	1Z			08.95 →	0 460 404 970 0 986 440 568
TDI syncro [1H1]	1,9	66	1Z			03.95-06.95	0 460 404 994 0 986 440 555
						07.95-07.96	0 460 404 971 0 986 440 555
TDI, TDI syncro [1H1]	1,9	66	AHU			08.96-12.97	0 460 404 971 0 986 440 555
			ALE			05.96-12.97	0 460 404 970 0 986 440 568

Golf III Cabriolet							
1.9 TDI [1E7]	1,9	66	AHU			08.96-04.98	0 460 404 971 0 986 440 555
			ALE			04.97-04.98	0 460 404 970 0 986 440 568
			1Z			08.95-07.96	0 460 404 971 0 986 440 555
		81	AFN			09.96-04.98	0 460 404 969 0 986 440 554

Golf III Variant							
1.9 D [1H5]	1,9	47	1Y		Fg.Nr. →1H..SW180 000	07.93-10.94	0 460 484 046 0 986 440 239
					Fg.Nr. 1H..SW180 001 →	11.94-02.99	0 460 484 127 0 986 440 240
SDI [1H5]	1,9	47	AEY			01.95-02.99	0 460 404 964 0 986 440 551

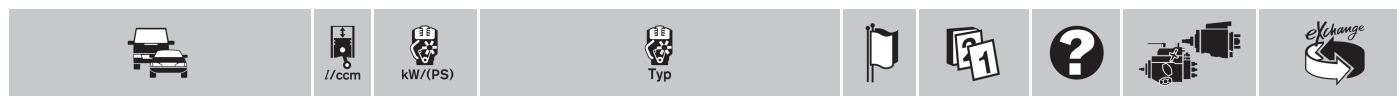

1.9 TD [1H5]	1,9	55	AAZ	CH	07.93-02.99	KL	0 460 494 314	0 986 440 142		
							KL	0 460 494 414		
					Fg.Nr. →1H..P..990 000	A,FIN, N,S	07.93-07.93	KL	0 460 494 306	
					Fg.Nr. →1H..RW160 000 →1H..RB040 000	A,FIN, N,S	07.93-09.93	KL	0 460 494 286	0 986 440 247
					Fg.Nr. →1H..SW180 000	A,FIN, N,S	07.93-10.94	KL	0 460 494 294	
					Fg.Nr. 1H..RW160 001→1H..SW180 000 1H..RB040 001→	A,FIN, N,S	10.93-10.94	KL	0 460 494 346	0 986 440 249
					Fg.Nr. 1H..R..000 001→1H..SW180 000	A,FIN, N,S	08.93-10.94	KL	0 460 494 347	
					Fg.Nr. 1H..SW180 001→	A,FIN, N,S	11.94-02.99	KL	0 460 494 362	
						A,FIN, N,S	11.94-02.99	KL	0 460 494 444	0 986 440 250
								KL	0 460 494 445	0 986 440 251
TDI [1H5]	1,9	66	AHU		08.96-02.99		0 460 404 971	0 986 440 555		
					ALE	05.97-02.99		0 460 404 970	0 986 440 568	
					1Z	07.93-07.96		0 460 404 971	0 986 440 555	
		81	AFN		02.96-02.99		0 460 404 969	0 986 440 554		
TDI syncro [1H5]	1,9	66	AHU		08.96-12.97		0 460 404 985	0 986 440 555		
					ALE	05.96-12.97		0 460 404 985	0 986 440 555	
					1Z	10.94-07.95		0 460 404 994	0 986 440 555	
					08.95-07.96		0 460 404 985	0 986 440 555		
<b>Golf IV</b>										
1.9 SDI [1J1]	1,9	50	AGP		10.97-04.01		0 460 404 972	0 986 440 556		
					AQM	11.98-05.04		0 460 404 972	0 986 440 556	
TDI [1J1]	1,9	66	ALH		10.97-05.04	GS	0 460 404 977	0 986 440 557		
					81	ASV	05.00-05.04		0 460 404 977	0 986 440 557
TDI [9B1]	1,9	66	AGR		07.01-06.02		0 460 404 977	0 986 440 557		
					ALH	07.01-03.07	GS	0 460 404 977	0 986 440 557	
TDI, TDI 4 Motion [1J1]	1,9	66/81	AGR; AHF		10.97-12.05		0 460 404 977	0 986 440 557		
<b>Golf IV Cabriolet</b>										
1.9 TDI [1E7]	1,9	66	AHU		04.98-06.00		0 460 404 971	0 986 440 555		
					ALE	04.98-12.01		0 460 404 970	0 986 440 568	
					81	AFN	04.98-08.99		0 460 404 969	0 986 440 554
						AVG	08.99-10.00		0 460 404 969	0 986 440 554
<b>Golf IV Station Wagon</b>										
1.9 TDI [1J5]	1,9	81	AHF		04.02-12.05		0 460 404 977	0 986 440 557		
<b>Golf IV Variant</b>										
1.9 SDI [1J5]	1,9	50	AGP		05.00-04.01		0 460 404 972	0 986 440 556		
					AQM	05.99-06.06		0 460 404 972	0 986 440 556	
TDI [1J5]	1,9	66	ALH		05.99-06.06	GS	0 460 404 977	0 986 440 557		
					81	ASV	05.00-06.06		0 460 404 977	0 986 440 557
TDI, TDI 4 Motion [1J5]	1,9	66/81	AGR; AHF		05.99-06.06		0 460 404 977	0 986 440 557		
<b>Jetta</b>										
1.6 D [1G2, 19E]	1,6	40	JP		01.84-10.91	AG	0 460 494 140			
						GS	0 460 494 241			
						WW	0 460 494 179			
					ME	CH	08.84-09.92		0 460 494 200	
D Turbo [1G2, 19E]	1,6	44	1V		08.89-07.92	CSA	0 460 484 027			
					51	JR	01.84-10.91	WW	0 460 494 138	
		59	RA		D	01.84-10.91		0 460 494 182	0 986 440 125	
					SB	04.89-02.90		0 460 494 239		
				08.89-10.91		0 460 494 267	0 986 440 135			
1.9 TD [1H2/1W2]	1,9	55	AAZ		10.92-08.93	KL	0 460 494 306			
					Fg.Nr. →1H-S-048 651	10.92-10.94	KL	0 460 494 294		
					Fg.Nr. 1H-R-045 251→1H-S-048 650	08.93-10.94	KL	0 460 494 347		
					Fg.Nr. 1H-S-048 651→	10.94-07.98	KL	0 460 494 362		
					TDI [1H2/1W2]	08.95→		0 460 404 970	0 986 440 568	
<b>Jetta IV</b>										
1.9 TDI	1,9	81	AHF		09.99-12.05	GS	0 460 404 977	0 986 440 557		





◀ VW

<b>Lupo</b>									
1.7 SDI [6X1]	1,7	42	AKU		10.98-07.05			<b>0 460 404 967</b>	<b>0 986 440 553</b>
<b>New Beetle</b>									
1.9 TDI [1C1/9C1]	1,9	66	ALH						
				Fg.Nr. →1C...3..999 000	01.98-06.03	GS		<b>0 460 404 977</b>	<b>0 986 440 557</b>
				Fg.Nr. 1C..4..000 001→	07.03-06.04	GS		<b>0 460 404 959</b>	<b>0 986 440 557</b>
<b>Passat</b>									
1.6 D [32]	1,6	40	BE <222>		09.81-05.86			<b>0 460 494 075</b>	
					06.86-06.89			<b>0 460 494 165</b>	
D [32B]	1,6	40	JK		08.83-03.88	AG		<b>0 460 494 140</b>	
						TW		<b>0 460 494 131</b>	
					A,D 08.85-03.88	AGF		<b>0 460 494 179</b>	
TD [32B]	1,6	51	CY		08.83-03.88			<b>0 460 494 138</b>	
					A,D 08.85-03.88	AGF		<b>0 460 494 182</b>	<b>0 986 440 125</b>
TD [312/351/3A2]	1,6	59	RA		08.88-07.89			<b>0 460 494 239</b>	
			SB		08.89-06.90			<b>0 460 494 252</b>	<b>0 986 440 135</b>
					07.90-09.93			<b>0 460 494 267</b>	<b>0 986 440 135</b>
1.9 D [312/351/3A2]	1,9	47	1Y		05.89-09.93			<b>0 460 484 022</b>	<b>0 986 440 084</b>
TD [312/351/3A2]	1,9	55	AAZ		03.91-07.91	CSA,KL		<b>0 460 494 287</b>	
					03.91-03.97	AG		<b>0 460 494 296</b>	
				Fg.Nr. →3A-S-050 000	10.93-08.94			<b>0 460 494 314</b>	<b>0 986 440 142</b>
						KL		<b>0 460 494 294</b>	
				Fg.Nr. →31-N-500 000	03.91-07.92			<b>0 460 494 277</b>	
				Fg.Nr. 3A-S-050 001→3A-S-300 000	08.94-07.95			<b>0 460 494 368</b>	<b>0 986 440 250</b>
						KL		<b>0 460 494 369</b>	<b>0 986 440 251</b>
				Fg.Nr. 3A-T-000 001→	07.95-03.97			<b>0 460 494 444</b>	<b>0 986 440 250</b>
						KL		<b>0 460 494 445</b>	<b>0 986 440 251</b>
				Fg.Nr. 31-P-000 001→	08.92-10.93			<b>0 460 494 336</b>	
				Fg.Nr. 31-P-000 001→3A-RE-044 453	08.91-10.93	KL		<b>0 460 494 323</b>	
TDI [3B2]	1,9	66	AHU		05.99-11.00			<b>0 460 404 971</b>	<b>0 986 440 555</b>
TDI [312/351/3A2]	1,9	66	AHU						
				Fg.Nr. 3A-T-000 001→	08.96-12.96			<b>0 460 404 971</b>	<b>0 986 440 555</b>
				1Z					
				Fg.Nr. →3A-S-300 000	10.93-07.95			<b>0 460 404 994</b>	<b>0 986 440 555</b>
				Fg.Nr. 3A-T-000 001→	07.95-07.96			<b>0 460 404 971</b>	<b>0 986 440 555</b>
		81	AFN		03.96-03.97			<b>0 460 404 969</b>	<b>0 986 440 554</b>
TDI, TDI syncro [3B2]	1,9	81	AFN		10.96-11.00			<b>0 460 404 969</b>	<b>0 986 440 554</b>
			AVG		08.99-11.00			<b>0 460 404 969</b>	<b>0 986 440 554</b>
2.5 TDI, TDI syncro [3B2]	2,5	110	AFB		08.98-11.00	VP4		<b>0 470 506 002</b>	<b>0 986 444 067</b>
			AKN		08.98-11.00	AG		<b>0 470 506 010</b>	<b>0 986 444 070</b>
						GS		<b>0 470 506 006</b>	<b>0 986 444 068</b>
TDI, TDI 4 Motion [3B3]	2,5	110	AKN		10.00-05.03	AG		<b>0 470 506 010</b>	<b>0 986 444 070</b>
						GS		<b>0 470 506 006</b>	<b>0 986 444 068</b>
		120/132	BDG; BDH		01.03-05.05	THI		<b>0 470 506 038</b>	<b>0 986 444 083</b>
TDI 4 Motion [3B3]	2,5	132	BAU		01.03-05.05	THI		<b>0 470 506 033</b>	<b>0 986 444 073</b>
<b>Passat Variant</b>									
1.6 D [32B]	1,6	40	JK		08.83-03.88	AG		<b>0 460 494 140</b>	
						TW		<b>0 460 494 131</b>	
					A,D 08.85-03.88	AGF		<b>0 460 494 179</b>	
TD [32B]	1,6	51	CY		08.83-03.88			<b>0 460 494 138</b>	
					A,D 08.85-03.88	AGF		<b>0 460 494 182</b>	<b>0 986 440 125</b>
TD [315/351/3A5]	1,6	59	RA		08.88-07.89			<b>0 460 494 239</b>	
			SB		08.89-06.90			<b>0 460 494 252</b>	<b>0 986 440 135</b>
					07.90-09.93			<b>0 460 494 267</b>	<b>0 986 440 135</b>
1.9 D [315/351/3A5]	1,9	47	1Y		05.89-09.93			<b>0 460 484 022</b>	<b>0 986 440 084</b>







1.9 TD [315/35l/3A5]	1,9	55	AAZ	03.91-07.91	CSA, KL	0 460 494 287							
				03.91-03.97	AG	0 460 494 296							
				Fg.Nr. →3A-S-050 000	10.93-08.94		0 460 494 314	0 986 440 142					
						KL	0 460 494 294						
				Fg.Nr. →31-N-500 000	03.91-07.92		0 460 494 277						
				Fg.Nr. 3A-S-050 001→3A-S-300 000	08.94-07.95		0 460 494 368	0 986 440 250					
						KL	0 460 494 369	0 986 440 251					
				Fg.Nr. 3A-T-000 001→	07.95-03.97		0 460 494 444	0 986 440 250					
						KL	0 460 494 445	0 986 440 251					
				Fg.Nr. 31-P-000 001→	08.92-10.93		0 460 494 336						
Fg.Nr. 31-P-000 001→3A-RE-044 453	08.91-10.93	KL	0 460 494 323										
TDI [3B5]	1,9	66	AHU	05.97-11.00		0 460 404 971	0 986 440 555						
TDI [315/35l/3A5]	1,9	66	AHU	Fg.Nr. 3A-T-000 001→	08.96-03.97		0 460 404 971	0 986 440 555					
									1Z				
									Fg.Nr. →3A-S-300 000	10.93-07.95		0 460 404 994	0 986 440 555
									Fg.Nr. 3A-T-000 001→	07.95-07.96		0 460 404 971	0 986 440 555
										03.96-03.97		0 460 404 969	0 986 440 554
TDI, TDI syncro [3B5]	1,9	81	AFN	05.97-11.00		0 460 404 969	0 986 440 554						
				AVG	08.99-11.00		0 460 404 969	0 986 440 554					
2.5 TDI, TDI syncro [3B5]	2,5	110	AFB	08.98-11.00	VP4	0 470 506 002	0 986 444 067						
				AKN	05.99-11.00	AG	0 470 506 010	0 986 444 070					
						GS	0 470 506 006	0 986 444 068					
TDI, TDI 4 Motion [3B6]	2,5	110	AKN	10.00-05.03	AG	0 470 506 010	0 986 444 070						
					GS	0 470 506 006	0 986 444 068						
				120/132	BDG; BDH	01.03-05.05	THI	0 470 506 038	0 986 444 083				
TDI 4 Motion [3B6]	2,5	132	BAU	01.03-05.05	THI	0 470 506 033	0 986 444 073						
<b>Polo</b>													
1.3 D [86,87]	1,3	33	MN	Mot.Nr. MN 054 044→	10.89-08.90	0 460 484 021							
				Mot.Nr. →MN 054 043	08.86-10.89	0 460 484 011							
					10.90-09.94	0 460 484 033	0 986 440 238						
1.4 D [80]	1,4	35	1W	10.90-09.94		0 460 484 033	0 986 440 238						
1.7 SDI [6N1]	1,7	42/44	AHG; AKU	04.97-12.99		0 460 404 967	0 986 440 553						
				10.99-09.01		0 460 404 967	0 986 440 553						
1.9 D [6N1]	1,9	47	AEF	10.94-12.99	WEG	0 460 484 071	0 986 440 240						
				Fg.Nr. 6N-T-000 001→	07.95-12.99	WEG	0 460 484 077						
				AGD									
				Fg.Nr. →6N-V 160 000	07.96-12.99		0 460 404 964	0 986 440 551					
				Fg.Nr. 6N-V-160 001→	07.96-12.99		0 460 404 966	0 986 440 552					
SDI	1,9	47	ASY	05.02→		0 460 404 972	0 986 440 556						
SDI [6N2]	1,9	47	AGD	10.99-09.01		0 460 404 966	0 986 440 552						
				10.99-09.01		0 460 404 967	0 986 440 553						
SDI [9N1]	1,9	47	ASY	09.01-05.05		0 460 404 972	0 986 440 556						
SDI [9N2]	1,9	47	ASY	11.03-05.07		0 460 404 972	0 986 440 556						
SDI [9N3]	1,9	47	ASY	04.05-12.09		0 460 404 972	0 986 440 556						
<b>Polo Classic</b>													
1.3 D [86,87]	1,3	33	MN	Mot.Nr. MN 054 044→	10.89-08.90	0 460 484 021							
				Mot.Nr. →MN 054 043	08.86-10.89	0 460 484 011							
					10.90-09.94	0 460 484 033	0 986 440 238						
1.4 D [80]	1,4	35	1W	10.90-09.94		0 460 484 033	0 986 440 238						
1.7 SDI [6V2]	1,7	44	AKW	Mot.Nr. AKW 001 850→	05.98-08.99	0 460 404 962							
				Mot.Nr. →AKW 001 849	11.97-04.98	0 460 404 967	0 986 440 553						
1.9 D [6V2]	1,9	47	1Y	01.96-04.96	MLK	0 460 484 128	0 986 440 241						
					OLK	0 460 484 127	0 986 440 240						
					05.96-08.00		0 460 484 127	0 986 440 240					
					05.96→	KL	0 460 484 161						
SD	1,9	47	1Y <M9N>	09.00→	KL	0 460 484 128	0 986 440 241						
						0 460 484 160	0 986 440 240						





◀ VW

1.9 SDI [6V2]	1,9	47	AEY	Fg.Nr. →6K..V..247 164 →6K..W..021 847	12.95-04.97	0 460 404 964	0 986 440 551						
				Fg.Nr. 6K..V..247 165 → Mot.Nr. AEY 134 671	05.97-12.98	0 460 404 966	0 986 440 552						
				Fg.Nr. 6K..W..021 848 →									
				Mot.Nr. AEY 134 672 →	01.99-08.99	0 460 404 961	0 986 440 570						
	50	AGP	10.99-09.01	0 460 404 972	0 986 440 556								
			AQM	10.99-09.01	0 460 404 972	0 986 440 556							
	TDI	1,9	66	AGR	09.00 →		0 460 404 977	0 986 440 557					
					AHU <M2K>	03.99-08.00	KL	0 460 484 161					
	TDI [6V2]	1,9	66	AGR	10.99-09.01		0 460 404 977	0 986 440 557					
					AHU	07.96-08.99		0 460 404 971	0 986 440 555				
81		AFN	08.98-08.99		0 460 404 969	0 986 440 554							
			ASV	10.99-09.01		0 460 404 977	0 986 440 557						
1.3 D [86,87]		1,3	33	MN	Mot.Nr. MN 054 044 →	10.89-08.90	0 460 484 021						
					Mot.Nr. →MN 054 043	08.86-10.89	0 460 484 011						
		1.4 D [80]	1,4	35	1W		10.90-09.94	0 460 484 033	0 986 440 238				
						<b>Polo Coupé</b>							
						1.9 SDI	1,9	47	ASY		11.02 →	0 460 404 972	0 986 440 556
										<b>Polo Variant</b>			
1.7 SDI [6V5]	1,7	44	AKW	Mot.Nr. AKW 001 850 →	05.98-08.99	0 460 404 962							
				Mot.Nr. →AKW 001 849	11.97-04.98	0 460 404 967	0 986 440 553						
1.9 SDI [6V5]	1,9	47	AEY	Mot.Nr. AEY 134 672 →	01.99-08.99	0 460 404 961	0 986 440 570						
				Mot.Nr. →AEY 134 671	06.97-12.98	0 460 404 966	0 986 440 552						
				50	AGP	10.99-09.01	0 460 404 972	0 986 440 556					
						AQM	10.99-09.01	0 460 404 972	0 986 440 556				
	TDI [6V5]	1,9	66	AGR	10.99-09.01		0 460 404 977	0 986 440 557					
					AHU	06.97-08.99		0 460 404 971	0 986 440 555				
		81	AFN	06.98-08.99		0 460 404 969	0 986 440 554						
				ASV	10.99-09.01		0 460 404 977	0 986 440 557					
		<b>Santana</b>											
		1.6 D [32]	1,6	40	JK		06.85-03.88	AG	0 460 494 140				
						TW	0 460 494 131						
D Turbo [32]	1,6	51	CY		06.85-03.88		0 460 494 138						
<b>Sharan</b>													
1.9 TDI [7M8]	1,9	66	AHU	07.96-04.98		0 460 404 971	0 986 440 555						
				1Z	09.95-07.96		0 460 404 971	0 986 440 555					
		81	AFN	09.96-02.00		0 460 404 979	0 986 440 567						
				AVG	08.99-02.00		0 460 404 968	0 986 440 567					
<b>Vento</b>													
1.9 D [1H2]	1,9	47	1Y		11.91-12.97	0 460 484 127	0 986 440 240						
SDI [1H2]	1,9	47	AEY		01.95-12.97	0 460 404 964	0 986 440 551						





1.9 TD [1H2]	1,9	55	AAZ	CH	11.91-12.97		<b>0 460 494 314</b>	<b>0 986 440 142</b>	
				Fg.Nr. →1H..P..990 000	A,FIN, N,S	11.91-07.93		<b>0 460 494 306</b>	
				Fg.Nr. →1H..RW160 000 →1H..RB040 000	A,FIN, N,S	11.91-09.93	KL	<b>0 460 494 286</b>	<b>0 986 440 247</b>
				Fg.Nr. →1H..SW180 000	A,FIN, N,S	11.91-09.94	KL	<b>0 460 494 294</b>	
				Fg.Nr. 1H..RW160 001→1H..SW180 000 1H..RB040 001→	A,FIN, N,S	09.93-09.94	KL	<b>0 460 494 346</b>	<b>0 986 440 249</b>
				Fg.Nr. 1H..R..000 001→1H..SW180 000	A,FIN, N,S	07.93-09.94		<b>0 460 494 347</b>	
				Fg.Nr. 1H..SW180 000→	A,FIN, N,S	10.94-12.97	KL	<b>0 460 494 362</b>	
					A,FIN, N,S	10.94-12.97	KL	<b>0 460 494 444</b>	<b>0 986 440 250</b>
							KL	<b>0 460 494 445</b>	<b>0 986 440 251</b>
								<b>0 460 494 445</b>	<b>0 986 440 251</b>
TDI [1H2]	1,9	66	AHU		08.96-12.97		<b>0 460 404 971</b>	<b>0 986 440 555</b>	
			ALE		05.97-12.97		<b>0 460 404 970</b>	<b>0 986 440 568</b>	
			1Z		07.95-07.96		<b>0 460 404 971</b>	<b>0 986 440 555</b>	
			81 AFN		02.96-12.97		<b>0 460 404 969</b>	<b>0 986 440 554</b>	





**ALFA ROMEO**

AR 6						
10	2,5	53	8144.61.200		04.85-02.86	0 460 494 109
		55	8144.67.220		03.86-12.89	0 460 494 189
13	2,5	53	8144.61.200		04.85-02.86	0 460 494 109
14	2,5	55	8144.67.220		03.86-12.89	0 460 494 189
Turbo	2,5	68	8144.21.220		09.86-12.89	0 460 414 008 0 986 440 023
AR 8						
30	2,5	53	8140.61.200		07.84-12.89	0 460 494 109
35	2,5	53	8140.61.200		07.84-12.89	0 460 494 109
Turbo	2,5	68	8140.21.200 D.I.		04.85-12.88	0 460 414 008 0 986 440 023
40	2,5	53	8140.61.200		07.84-12.88	0 460 494 109
Turbo	2,5	68	8140.21.200 D.I.		04.85-12.88	0 460 414 008 0 986 440 023

**ASKAM**

Serie HI-EX						
19 .300	6,9	292	D0836 LFL01		09.03→	0 470 506 009 0 986 444 010
26 .300	6,9	292	D0836 LFL01		09.03→	0 470 506 009 0 986 444 010
32 .300	6,9	292	D0836 LFL01		09.03→	0 470 506 009 0 986 444 010

**AVIA**

A						
21 T	3,6	76	D421.76 II		01.99-07.00 CSA	0 460 424 171
			D421.76.01 <Euro 2>		10.96-12.98	0 460 424 151
31 T	3,6	76	D421.76 II		01.99-07.00 CSA	0 460 424 171
			D421.76.01 <Euro 2>		10.96-12.98	0 460 424 151
60	3,6	76	D421.76 II		01.99-07.00 CSA	0 460 424 171
			D421.76.00 <Euro 2>		10.96-12.98	0 460 424 151
		85	D421.85.00 <Euro 2>		01.97-07.00	0 460 424 162
75	3,6	76	D421.76 II		01.99-07.00 CSA	0 460 424 171
			D421.76.00 <Euro 2>		10.96-12.98	0 460 424 151
		85	D421.85.00 <Euro 2>		01.97-07.00	0 460 424 162

**CHEVROLET**

D						
40	4,0	68	S4 <Euro 1>		03.92-09.95	0 460 424 082
					10.95-10.96	0 460 424 127
Luv						
3.0 D-MAX	3,0	96	4JH1-TC		09.04→	0 470 504 037
Serie D						
10	3,4	57	4.236 V		10.84-12.94	0 460 414 001
20	3,9	66	Q20B4236		01.85-02.92	0 460 414 035
	4,0	68	S4 <Euro 1>		03.92-09.95	0 460 424 082
					10.95-10.95	0 460 424 127
Plus	4,0	99	S4T <Euro 1>		03.92-08.95	0 460 424 083
					09.95-10.96	0 460 424 096
Turbo	4,0	88	S4T		03.92-08.95	0 460 424 083
					09.95-10.96	0 460 424 096
					11.96-08.97	0 460 424 133
Silverado						
4.1 D	4,1	66	S4		11.96-12.01	0 460 424 175





## CITROEN

C						
25 1.9 D	1,9	51	D9B <XUD9A>	07.87-09.87	BO	0 460 494 211
				10.87-02.88	BO	0 460 494 222
				03.88-03.94	BO	0 460 494 240
35 2.5 D	2,5	50	CRD93B <B 25/637>	10.83-10.90	BO	0 460 394 043 0 460 394 044
Jumper						
1.9 D [23]	1,9	51	DJY <XUD9>	01.99-02.02	WEG	0 460 484 070
					WZT	0 460 484 146
			D9B <XUD9AU>	02.94-10.94	WEG	0 460 484 054
				02.94-08.98	WZT	0 460 484 091
				11.94-02.02	WEG	0 460 484 064 0 986 440 094
				09.98-02.02	WZT	0 460 484 111
D Turbo [23]	1,9	66-68	DHX <XUD9UTF>	02.94-12.95	WEG	0 460 494 341
				02.94-02.02	EFV,WEG	0 460 494 423 0 986 440 156
					N05,WZT	0 460 494 430
					N11,WZT	0 460 494 383
			D8C <XUD9UTF>	02.94-11.94	WEG	0 460 494 342
				02.94-02.02	N03,WZT	0 460 494 428
					WEG	0 460 494 383
					WZT	0 460 494 388
				10.94-12.95	N05,WEG	0 460 494 341
				12.94-02.02	N09,WEG	0 460 494 370
				01.96-02.02	N05,WEG	0 460 494 423 0 986 440 156
2.5 D [23]	2,5	63	T9A <DJ5>	06.98-02.02	WEG	0 460 494 459
					WZT	0 460 494 460
			Fg.Nr. →15382156	02.94-02.97		0 460 494 337 0 986 440 146
			Fg.Nr. 15382157→	03.97-05.98		0 460 494 429
TDi [23]	2,5	79	THX <DJ5TED>	10.96-02.02	WEG	0 460 414 140 0 986 440 051
					WEG	0 460 414 156
2.8 T	2,8	77	8140 43	12.01-08.05		0 460 494 484

## DAF

45						
.130	5,9	96	CN 95 <6 BTA 130>	05.91-12.97	TW	0 460 426 212
.150 Turbo	5,9	107	CB 107 <6 BTA 145>	05.91-12.97	TW	0 460 426 213
.160 Turbo	5,9	119	CT 119 <6 BTA 160>	05.91-12.97	TW	0 460 426 211

## EBRO (MISA)

L						
35 S, SF	3,9	62	4.236	05.85-06.90		0 460 424 017
45 , F	3,9	56-62	4.236	01.85-06.90		0 460 424 017
60	3,9	56-62	4.236	01.85-06.90		0 460 424 017
80	5,8	88	6.354.3	02.87-05.87		0 460 426 001
Turbo	3,9	72	4.236	05.85-06.90		0 460 424 017
M						
100	5,8	82-88	6.354.3	07.79-05.87		0 460 426 001
125	5,8	82-88	6.354.3	07.79-05.87		0 460 426 001
Trade						
2.0	2,0	41-44	Nissan-LD 20 E	09.84-02.87		9 460 610 019 9 460 610 093
65						
/7 D	3,9	66-71	T4.236	01.85-06.90		0 460 424 017
100						
/8 D	5,8	110-111	T6.354.3 CC	04.84-05.87		0 460 426 001





**FIAT**

**Ducato**

2.5 D	2,5	62	8140.67.2200	11.97-12.99		<b>0 460 404 084</b>
2.8 D	2,8	63	8140.63.22.60 <PC/NA>	04.99-05.05	TW	<b>0 460 494 466 0 986 440 163</b>
						<b>0 460 494 477</b>
D Turbo	2,8	90	8140.43.22.00 <ID/TCA>	04.99-08.00		<b>0 460 424 152</b>
				09.00-12.01		<b>0 460 424 227</b>
				01.02-05.05		<b>0 460 424 252</b>

**Ducato Cargo**

2.5 D	2,5	62	8140.67.2200	11.97-05.05		<b>0 460 404 084</b>
2.8 D	2,8	63	8140.63.22.60 <PC/NA>	04.99-05.05	TW	<b>0 460 494 466 0 986 440 163</b>
						<b>0 460 494 477</b>
D Turbo	2,8	90	8140.43.22.00 <ID/TCA>	04.99-08.00		<b>0 460 424 152</b>
				09.00-12.01		<b>0 460 424 227</b>
				01.02-05.05		<b>0 460 424 252</b>
				01.04-05.05	FWT	<b>0 460 424 248</b>
D Turbo Interc.	2,8	103,3	8140.23.22.00 <ID/TC>	09.00-12.01		<b>0 460 424 227</b>
				01.02-05.05		<b>0 460 424 252</b>

**Ducato Combinato**

2.8 D, iDTD	2,8	66/76	8140.63	06.98→		<b>0 460 494 483</b>
-------------	-----	-------	---------	--------	--	----------------------

**Ducato Furgon**

2.8 D	2,8	66	8140.63	06.98-11.04		<b>0 460 494 483</b>
-------	-----	----	---------	-------------	--	----------------------

**Ducato Furgon Maxi**

2.8 D	2,8	66	8140.63	09.98-01.03		<b>0 460 494 483</b>
-------	-----	----	---------	-------------	--	----------------------

**Ducato 10**

1.9 D [230..]	1,9	50	DJY <M11>	04.98-10.01	BOW	<b>0 460 484 146</b>
					BOW	<b>0 460 484 070</b>
		51	230 A 2.000 <M1>	03.94-03.98	BOW	<b>0 460 494 401</b>
					BOW	<b>0 460 494 349</b>
D [279..]	1,9	52	149 B 1.000 <M1>	07.90-02.94		<b>0 460 494 214</b>
D [280..]	1,9	52	149 B 1.000	02.87-06.90		<b>0 460 494 214</b>
TD [230..]	1,9	60	230 A 3.000 <M2>	03.94-03.98	BOW	<b>0 460 494 400</b>
					BOW	<b>0 460 494 348</b>
		66	DHX <M12>	04.98-10.01	BOW	<b>0 460 494 430</b>
					BOW	<b>0 460 494 423 0 986 440 156</b>
TD [279..]	1,9	60	280 A 1.000 <M2>	07.90-02.94		<b>0 460 494 187</b>
TD [280..]	1,9	60	280 A1.000	02.87-06.90		<b>0 460 494 187</b>
TD CAT [230..]	1,9	59	230 A 4.000 <M3>	03.94-03.98	BOW	<b>0 460 494 402</b>
					BOW	<b>0 460 494 349</b>
2.5 D [230..]	2,5	62	8140.67 <M4>	11.95-03.98	BOW	<b>0 460 404 084</b>
			Fg.Nr. →5202307	03.94-10.95	BOW	<b>0 460 404 077</b>
D [280..]	2,5	55	8144.67	01.86-06.90		<b>0 460 494 189</b>
TD [279..]	2,5	70	8140.27 <M4>	07.90-02.94		<b>0 460 414 081 0 986 440 033</b>
TD ECO [230..]	2,5	80	8140.47R <M7>	03.94-03.98		<b>0 460 414 996 0 986 440 524</b>
TD EGR [230..]	2,5	85	8140.47 <M6>	11.97-03.98	BOW,CSA	<b>0 460 414 164</b>
			Fg.Nr. →5202307	03.94-03.98	BOW	<b>0 460 414 104</b>
			Fg.Nr. 5202308→	03.94-10.97	BOW	<b>0 460 414 129</b>
TD EGR 4x4 [234..]	2,5	85	8140.47 <M6>	11.97-03.98	BOW,CSA	<b>0 460 414 164</b>
			Fg.Nr. →5202307	03.94-03.98	BOW	<b>0 460 414 104</b>
			Fg.Nr. 5202308→	03.94-10.97	BOW	<b>0 460 414 129</b>
TD 4x4 [234..]	2,5	85	8140.47 <M5>	03.94-03.98	BOW	<b>0 460 414 128</b>
			Mot.Nr. →1997700	03.94-03.98	BOW	<b>0 460 414 091</b>
			Mot.Nr. 1997701→FG-Nr.5202307	03.94-03.98	BOW	<b>0 460 414 120</b>
2.8 D [230..]	2,8	64	8140.63 <M10>	04.98-03.02		<b>0 460 494 466 0 986 440 163</b>
TD [230..]	2,8	90	8140.43 <M8>			
			Mot.Nr. →3050379	10.97-03.00		<b>0 460 424 152</b>
			Mot.Nr. 30503780→	04.00-03.02		<b>0 460 424 220</b>
TD EGR [230..]	2,8	90	8140.43 <M9>			
			Mot.Nr. →3050379	10.97-03.00	CSA	<b>0 460 424 164</b>





<b>2.8</b> TD EGR 4x4 [234..]	2,8	90	8140.43 <M9>					
			Mot.Nr. →3050379		10.97-03.00	CSA	<b>0 460 424 164</b>	
TD 4x4 [234..]	2,8	90	8140.43 <M8>					
			Mot.Nr. →3050379		10.97-03.00		<b>0 460 424 152</b>	
			Mot.Nr. 30503780→		04.00-03.02		<b>0 460 424 220</b>	
<b>Ducato 11</b>								
<b>2.8</b> TD [243..]	2,8	90	8140.43 <M25>		10.02-08.06		<b>0 460 424 220</b>	
<b>Ducato 12</b>								
<b>2.5</b> D 4x4 [284..]	2,5	55	8144.67 <M1>		07.90-02.94		<b>0 460 494 189</b>	
TD 4x4 [284..]	2,5	70	8140.27 <M2>		07.90-02.94		<b>0 460 414 081</b>	<b>0 986 440 033</b>
<b>Ducato 14</b>								
<b>1.9</b> TD [231..]	1,9	60	230 A 3.000 <M2>		03.94-03.98	BOW	<b>0 460 494 400</b>	
						BOW	<b>0 460 494 348</b>	
		66	DHX <M12>		04.98-10.01	BOW	<b>0 460 494 430</b>	
						BOW	<b>0 460 494 423</b>	<b>0 986 440 156</b>
TD [280..]	1,9	60	280 A 1.000 <M2>; 280 A1.000		02.87-02.94		<b>0 460 494 187</b>	
TD CAT [231..]	1,9	59	230 A 4.000 <M3>		03.94-03.98	BOW	<b>0 460 494 402</b>	
						BOW	<b>0 460 494 349</b>	
<b>2.5</b> D [231..]	2,5	62	8140.67 <M4>		11.95-03.98	BOW	<b>0 460 404 084</b>	
			Fg.Nr. →5202307		03.94-10.95	BOW	<b>0 460 404 077</b>	
D, D 4x4 [280..]	2,5	55	8144.67; 8144.67 <M3>		01.86-02.94		<b>0 460 494 189</b>	
TD [231..]	2,5	85	8140.47 <M5>		03.94-03.98	BOW	<b>0 460 414 128</b>	
			Mot.Nr. →1997700		03.94-03.98	BOW	<b>0 460 414 091</b>	
			Mot.Nr. 1997701→ FG-Nr.5202307		03.94-03.98	BOW	<b>0 460 414 120</b>	
TD [280..]	2,5	70	8140.27 <M4>		07.90-02.94		<b>0 460 414 081</b>	<b>0 986 440 033</b>
TD ECO [231..]	2,5	80	8140.47R <M7>		03.94-03.98		<b>0 460 414 996</b>	<b>0 986 440 524</b>
TD ECO 4x4 [234..]	2,5	80	8140.47R <M7>		03.94-03.98		<b>0 460 414 996</b>	<b>0 986 440 524</b>
TD EGR [231..]	2,5	85	8140.47 <M6>		11.97-03.98	BOW,CSA	<b>0 460 414 164</b>	
			Fg.Nr. →5202307		03.94-03.98	BOW	<b>0 460 414 104</b>	
			Fg.Nr. 5202308→		03.94-10.97	BOW	<b>0 460 414 129</b>	
TD EGR 4x4 [234..]	2,5	85	8140.47 <M6>		11.97-03.98	BOW,CSA	<b>0 460 414 164</b>	
			Fg.Nr. →5202307		03.94-03.98	BOW	<b>0 460 414 104</b>	
			Fg.Nr. 5202308→		03.94-10.97	BOW	<b>0 460 414 129</b>	
TD, TD 4x4 [280..]	2,5	68	8144.21		01.86-06.90	BO	<b>0 460 414 008</b>	<b>0 986 440 023</b>
<b>2.8</b> D [231..]	2,8	64	8140.63 <M10>		04.98-03.02		<b>0 460 494 466</b>	<b>0 986 440 163</b>
TD [231..]	2,8	90	8140.43 <M8>					
			Mot.Nr. →3050379		10.97-03.00		<b>0 460 424 152</b>	
			Mot.Nr. 30503780→		04.00-03.02		<b>0 460 424 220</b>	
TD EGR [231..]	2,8	90	8140.43 <M9>					
			Mot.Nr. →3050379		10.97-03.00	CSA	<b>0 460 424 164</b>	
TD EGR 4x4 [234..]	2,8	90	8140.43 <M9>					
			Mot.Nr. →3050379		10.97-03.00	CSA	<b>0 460 424 164</b>	
TD 4x4 [234..]	2,8	90	8140.43 <M8>					
			Mot.Nr. →3050379		10.97-03.00		<b>0 460 424 152</b>	
			Mot.Nr. 30503780→		04.00-03.02		<b>0 460 424 220</b>	
<b>Ducato 15</b>								
<b>2.8</b> TD [244..]	2,8	90	8140.43 <M25>		10.02-08.06		<b>0 460 424 220</b>	
TD 4x4 [247..]	2,8	90	8140.43 <M25>		10.02-08.06		<b>0 460 424 220</b>	
<b>Ducato 18</b>								
<b>2.5</b> D [232..]	2,5	62	8140.67 <M4>		11.95-03.98	BOW	<b>0 460 404 084</b>	
			Fg.Nr. →5202307		03.94-10.95	BOW	<b>0 460 404 077</b>	
D Maxi [280..]	2,5	55	8144.67		01.86-06.90		<b>0 460 494 189</b>	
D Maxi [282..]	2,5	55	8144.67 <M3>		07.90-02.94		<b>0 460 494 189</b>	
D 4x4 [234..]	2,5	62	8140.67 <M4>		11.95-03.98	BOW	<b>0 460 404 084</b>	
			Fg.Nr. →5202307		03.94-10.95	BOW	<b>0 460 404 077</b>	
TD [232..]	2,5	85	8140.47 <M5>		03.94-03.98	BOW	<b>0 460 414 128</b>	
			Mot.Nr. →1997700		03.94-03.98	BOW	<b>0 460 414 091</b>	
			Mot.Nr. 1997701→ FG-Nr.5202307		03.94-03.98	BOW	<b>0 460 414 120</b>	
TD ECO [232..]	2,5	80	8140.47R <M7>		03.94-03.98		<b>0 460 414 996</b>	<b>0 986 440 524</b>
TD Maxi [280..]	2,5	68	8144.21		01.86-06.90	BO	<b>0 460 414 008</b>	<b>0 986 440 023</b>
TD Maxi [282..]	2,5	70	8140.27 <M4>		07.90-02.94		<b>0 460 414 081</b>	<b>0 986 440 033</b>





◀ FIAT

<b>2.5 TD 4x4 [234..]</b>	2,5	85	8140.47 <M5>	03.94-03.98	BOW	<b>0 460 414 128</b>	
			Mot.Nr. →1997700	03.94-03.98	BOW	<b>0 460 414 091</b>	
			Mot.Nr. 1997701→FG-Nr.5202307	03.94-03.98	BOW	<b>0 460 414 120</b>	
<b>2.8 D [232..]</b>	2,8	64	8140.63 <M10>	04.98-03.02		<b>0 460 494 466</b>	<b>0 986 440 163</b>
D 4x4 [234..]	2,8	64	8140.63 <M10>	04.98-03.02		<b>0 460 494 466</b>	<b>0 986 440 163</b>
TD [232..]	2,8	90	8140.43 <M8>				
			Mot.Nr. →3050379	10.97-03.00		<b>0 460 424 152</b>	
			Mot.Nr. 30503780→	04.00-03.02		<b>0 460 424 220</b>	
TD [245..]	2,8	90	8140.43 <M25>	10.02-08.06		<b>0 460 424 220</b>	
TD EGR [232..]	2,8	90	8140.43 <M9>				
			Mot.Nr. →3050379	10.97-03.00	CSA	<b>0 460 424 164</b>	
TD EGR 4x4 [234..]	2,8	90	8140.43 <M9>				
			Mot.Nr. →3050379	10.97-03.00	CSA	<b>0 460 424 164</b>	
TD 4x4 [234..]	2,8	90	8140.43 <M8>				
			Mot.Nr. →3050379	10.97-03.00		<b>0 460 424 152</b>	
			Mot.Nr. 30503780→	04.00-03.02		<b>0 460 424 220</b>	
TD 4x4 [247..]	2,8	90	8140.43 <M25>	10.02-08.06		<b>0 460 424 220</b>	
<b>Talento</b>							
<b>1.9 D</b>	1,9	51	149 B 1.000 <M1>	03.88-12.94		<b>0 460 494 214</b>	

**FORD**

<b>Econovan</b>							
<b>2.0 D</b>	2,0	41	RF <Mazda>	FIN,N	02.86-12.99	<b>9 460 610 189</b>	
				FIN,N	02.86-12.99	<b>9 460 610 188</b>	
					10.87-12.99	<b>9 460 610 304</b>	
						<b>9 460 610 305</b>	
<b>Serie F</b>							
<b>100 3.9 D 4x4</b>	3,9	49			01.83-08.99	TW	<b>0 460 424 183</b>
							<b>0 460 424 186</b>
							<b>0 460 424 208</b>
<b>250</b>	3,9	107	4BTAA		11.98-10.99		<b>0 460 424 186</b>
					11.99-03.06		<b>0 460 424 204</b>
	4,2	132	6.07 TCA		03.99-03.00	WEG	<b>0 460 426 319</b>
					04.00-03.06	WEG	<b>0 460 426 328</b>
<b>350</b>	3,9	88	B3.9 120 P -5 <Euro III>		09.05→		<b>0 460 424 348</b>
<b>Transit</b>							
<b>FT 80-190 [78]</b>	2,5	50	York <D25>		11.85-02.86		<b>0 460 414 018</b>
<b>FT 080 2.5 D [95]</b>	2,5	51	4FA <D25N>; 4FB <D25N>; 4FC <D25N>; 4FD <D25N>		08.94-07.95		<b>0 460 414 113</b> <b>0 986 440 043</b>
					08.95-10.96	WEG	<b>0 460 414 123</b> <b>0 986 440 048</b>
					08.96-08.97	WEG	<b>0 460 414 153</b> <b>0 986 440 219</b>
					11.96-08.97	WEG	<b>0 460 414 151</b>
					09.97-08.00	WEG	<b>0 460 414 142</b> <b>0 986 440 217</b>
						WEG	<b>0 460 414 141</b> <b>0 986 440 052</b>
2.5 DI [95]	2,5	56	4HB <D25P>; 4HC <D25P>		08.94-07.95		<b>0 460 414 108</b> <b>0 986 440 040</b>
					08.95-10.96	WEG	<b>0 460 414 119</b> <b>0 986 440 046</b>
					08.96-08.97	WEG	<b>0 460 414 152</b> <b>0 986 440 056</b>
					11.96-08.97	WEG	<b>0 460 414 150</b> <b>0 986 440 055</b>
					09.97-08.00	WEG	<b>0 460 414 146</b> <b>0 986 440 054</b>
						WEG	<b>0 460 414 145</b> <b>0 986 440 053</b>
<b>FT 100 2.5 D [95]</b>	2,5	51	4FA <D25N>; 4FB <D25N>; 4FC <D25N>; 4FD <D25N>		08.94-07.95		<b>0 460 414 113</b> <b>0 986 440 043</b>
					08.95-10.96	WEG	<b>0 460 414 123</b> <b>0 986 440 048</b>
					08.96-08.97	WEG	<b>0 460 414 153</b> <b>0 986 440 219</b>
					11.96-08.97	WEG	<b>0 460 414 151</b>
					09.97-08.00	WEG	<b>0 460 414 142</b> <b>0 986 440 217</b>
						WEG	<b>0 460 414 141</b> <b>0 986 440 052</b>
2.5 DI [95]	2,5	56	4HB <D25P>; 4HC <D25P>		08.94-07.95		<b>0 460 414 108</b> <b>0 986 440 040</b>
					08.95-10.96	WEG	<b>0 460 414 119</b> <b>0 986 440 046</b>
					08.96-08.97	WEG	<b>0 460 414 152</b> <b>0 986 440 056</b>
					11.96-08.97	WEG	<b>0 460 414 150</b> <b>0 986 440 055</b>
					09.97-08.00	WEG	<b>0 460 414 146</b> <b>0 986 440 054</b>
						WEG	<b>0 460 414 145</b> <b>0 986 440 053</b>







<b>FT 120</b> 2.5 D [95]	2,5	51	4FA <D25N>; 4FB <D25N>; 4FC <D25N>; 4FD <D25N>	08.94-07.95	<b>0 460 414 113</b>	<b>0 986 440 043</b>
				08.95-10.96	WEG <b>0 460 414 123</b>	<b>0 986 440 048</b>
				08.96-08.97	WEG <b>0 460 414 153</b>	<b>0 986 440 219</b>
				11.96-08.97	WEG <b>0 460 414 151</b>	
				09.97-08.00	WEG <b>0 460 414 142</b>	<b>0 986 440 217</b>
				WEG	<b>0 460 414 141</b>	<b>0 986 440 052</b>
2.5 DI [95]	2,5	56	4HB <D25P>; 4HC <D25P>	08.94-07.95	<b>0 460 414 108</b>	<b>0 986 440 040</b>
				08.95-10.96	WEG <b>0 460 414 119</b>	<b>0 986 440 046</b>
				08.96-08.97	WEG <b>0 460 414 152</b>	<b>0 986 440 056</b>
				11.96-08.97	WEG <b>0 460 414 150</b>	<b>0 986 440 055</b>
				09.97-08.00	WEG <b>0 460 414 146</b>	<b>0 986 440 054</b>
				WEG	<b>0 460 414 145</b>	<b>0 986 440 053</b>
<b>FT 150</b> 2.5 DI [95]	2,5	56	4HB <D25P>; 4HC <D25P>	08.94-07.95	<b>0 460 414 108</b>	<b>0 986 440 040</b>
				08.95-10.96	WEG <b>0 460 414 119</b>	<b>0 986 440 046</b>
				08.96-08.97	WEG <b>0 460 414 152</b>	<b>0 986 440 056</b>
				11.96-08.97	WEG <b>0 460 414 150</b>	<b>0 986 440 055</b>
				09.97-08.00	WEG <b>0 460 414 146</b>	<b>0 986 440 054</b>
				WEG	<b>0 460 414 145</b>	<b>0 986 440 053</b>
<b>FT 190</b> 2.5 DI [95]	2,5	56	4HB <D25P>; 4HC <D25P>	08.94-07.95	<b>0 460 414 108</b>	<b>0 986 440 040</b>
				08.95-10.96	WEG <b>0 460 414 119</b>	<b>0 986 440 046</b>
				08.96-08.97	WEG <b>0 460 414 152</b>	<b>0 986 440 056</b>
				11.96-08.97	WEG <b>0 460 414 150</b>	<b>0 986 440 055</b>
				09.97-08.00	WEG <b>0 460 414 146</b>	<b>0 986 440 054</b>
				WEG	<b>0 460 414 145</b>	<b>0 986 440 053</b>
<b>FT 240 K/S</b> 2.0 TD, 2.0 TDE [00]	2,0	55/63	D3FA <PD20>; F3FA <PD20>	08.00-07.06	<b>0 470 004 012</b>	<b>0 986 444 522</b>
<b>FT 260 K/S</b> 2.0 TD, 2.0 TDE [00]	2,0	55/63/ 74	ABFA <PD20>; D3FA <PD20>; F3FA <PD20>	08.00-07.06	<b>0 470 004 012</b>	<b>0 986 444 522</b>
2.4 TDE [00]	2,4	66	D2F... <PD24P>	04.01-07.06	<b>0 470 004 012</b>	<b>0 986 444 522</b>
<b>FT 280 K/S</b> 2.0 TD, 2.0 TDE [00]	2,0	55/63/ 74	ABFA <PD20>; D3FA <PD20>; F3FA <PD20>	08.00-07.06	<b>0 470 004 012</b>	<b>0 986 444 522</b>
2.4 TDE [00]	2,4	66	D2F... <PD24P>	04.01-07.06	<b>0 470 004 012</b>	<b>0 986 444 522</b>
<b>FT 280 L</b> 2.4 TDE [00]	2,4	55	F4FA <PD24>	01.00-09.03	<b>0 470 004 012</b>	<b>0 986 444 522</b>
			D2F... <PD24P>	01.00-07.06	<b>0 470 004 012</b>	<b>0 986 444 522</b>
			FXFA <DuraTorq DI>	03.04-07.06	<b>0 470 504 041</b>	<b>0 986 444 076</b>
			DOFA <PD24PP>	01.00-04.03	<b>0 470 504 018</b>	<b>0 986 444 078</b>
				05.03-07.06	<b>0 470 504 041</b>	<b>0 986 444 076</b>
<b>FT 280 M</b> 2.0 TD, 2.0 TDE [00]	2,0	55/63/ 74	ABFA <PD20>; D3FA <PD20>; F3FA <PD20>	08.00-07.06	<b>0 470 004 012</b>	<b>0 986 444 522</b>
2.4 TDE [00]	2,4	66	D2F... <PD24P>	04.01-07.06	<b>0 470 004 012</b>	<b>0 986 444 522</b>
<b>FT 280 S</b> 2.4 TDI [00]	2,4	66	<IDI24>	01.01-05.06	WEG <b>0 460 414 219</b>	
<b>FT 300 K/S</b> 2.0 TD, 2.0 TDE [00]	2,0	55/63/ 74	ABFA <PD20>; D3FA <PD20>; F3FA <PD20>	08.00-07.06	<b>0 470 004 012</b>	<b>0 986 444 522</b>
<b>FT 300 L</b> 2.0 TD, 2.0 TDE [00]	2,0	55/63/ 74	ABFA <PD20>; D3FA <PD20>; F3FA <PD20>	08.00-07.06	<b>0 470 004 012</b>	<b>0 986 444 522</b>
<b>FT 300 M</b> 2.0 TD, 2.0 TDE [00]	2,0	55/63/ 74	ABFA <PD20>; D3FA <PD20>; F3FA <PD20>	08.00-07.06	<b>0 470 004 012</b>	<b>0 986 444 522</b>
<b>FT 300 S</b> 2.4 TDI [00]	2,4	66	<IDI24>	01.01-05.06	WEG <b>0 460 414 219</b>	
<b>FT 310 S</b> 2.4 TDI [00]	2,4	88	<IDI24>	01.01-05.06	WEG <b>0 460 414 216</b>	
					WEG <b>0 460 414 218</b>	
<b>FT 330 K/S</b> 2.0 TDE [00]	2,0	74	ABFA <PD20>	08.03-07.06	<b>0 470 004 012</b>	<b>0 986 444 522</b>
2.4 TD [00]	2,4	55	F4FA <PD24N>	01.00-09.03	<b>0 470 004 012</b>	<b>0 986 444 522</b>
2.4 TDE [00]	2,4	66	D2F... <PD24P>	01.00-07.06	<b>0 470 004 012</b>	<b>0 986 444 522</b>
			FXFA <DuraTorq DI>	03.04-07.06	<b>0 470 504 041</b>	<b>0 986 444 076</b>
			D4FA <PD24>	01.00-04.03	<b>0 470 504 018</b>	<b>0 986 444 078</b>
				05.03-07.06	<b>0 470 504 041</b>	<b>0 986 444 076</b>
				01.00-04.03	<b>0 470 504 018</b>	<b>0 986 444 078</b>
				05.03-07.06	<b>0 470 504 041</b>	<b>0 986 444 076</b>
<b>FT 330 L</b> 2.0 TDE [00]	2,0	74	ABFA <PD20>	08.03-07.06	<b>0 470 004 012</b>	<b>0 986 444 522</b>
2.4 TD [00]	2,4	55	F4FA <PD24N>	01.00-09.03	<b>0 470 004 012</b>	<b>0 986 444 522</b>
2.4 TDE [00]	2,4	66	D2F... <PD24P>	01.00-07.06	<b>0 470 004 012</b>	<b>0 986 444 522</b>
			FXFA <DuraTorq DI>	03.04-07.06	<b>0 470 504 041</b>	<b>0 986 444 076</b>
			D4FA <PD24>	01.00-04.03	<b>0 470 504 018</b>	<b>0 986 444 078</b>
				05.03-07.06	<b>0 470 504 041</b>	<b>0 986 444 076</b>





◀ FORD

<b>FT 330 L 2.4 TDE [00]</b>	2,4	92	DOFA <PD24PP>	01.00-04.03		<b>0 470 504 018</b>	<b>0 986 444 078</b>
				05.03-07.06		<b>0 470 504 041</b>	<b>0 986 444 076</b>
2.4 TDI [00]	2,4	66	<IDI24>	01.01-05.06	WEG	<b>0 460 414 219</b>	
		88	<IDI24>	01.01-05.06	WEG	<b>0 460 414 216</b>	
					WEG	<b>0 460 414 218</b>	
<b>FT 330 M 2.0 TDE [00]</b>	2,0	74	ABFA <PD20>	08.03-07.06		<b>0 470 004 012</b>	<b>0 986 444 522</b>
2.4 TD [00]	2,4	55	F4FA <PD24N>	01.00-09.03		<b>0 470 004 012</b>	<b>0 986 444 522</b>
2.4 TDE [00]	2,4	66	D2F... <PD24P>	01.00-07.06		<b>0 470 004 012</b>	<b>0 986 444 522</b>
		85	FXFA <DuraTorq DI>	03.04-07.06		<b>0 470 504 041</b>	<b>0 986 444 076</b>
		88	D4FA <PD24>	01.00-04.03		<b>0 470 504 018</b>	<b>0 986 444 078</b>
				05.03-07.06		<b>0 470 504 041</b>	<b>0 986 444 076</b>
		92	DOFA <PD24PP>	01.00-04.03		<b>0 470 504 018</b>	<b>0 986 444 078</b>
				05.03-07.06		<b>0 470 504 041</b>	<b>0 986 444 076</b>
2.4 TDI [00]	2,4	66	<IDI24>	01.01-05.06	WEG	<b>0 460 414 219</b>	
		88	<IDI24>	01.01-05.06	WEG	<b>0 460 414 216</b>	
					WEG	<b>0 460 414 218</b>	
<b>FT 330 S 2.4 TDI [00]</b>	2,4	66	<IDI24>	01.01-05.06	WEG	<b>0 460 414 219</b>	
		88	<IDI24>	01.01-05.06	WEG	<b>0 460 414 216</b>	
					WEG	<b>0 460 414 218</b>	
<b>FT 350 E 2.4 TDI [00]</b>	2,4	66	<IDI24>	01.01-05.06	WEG	<b>0 460 414 219</b>	
		88/96	<IDI24>	01.01-05.06	WEG	<b>0 460 414 216</b>	
					WEG	<b>0 460 414 218</b>	
<b>FT 350 EL 2.0 TDE [00]</b>	2,0	74	ABFA <PD20>	08.03-07.06		<b>0 470 004 012</b>	<b>0 986 444 522</b>
2.4 TD [00]	2,4	55	F4FA <PD24N>	01.00-09.03		<b>0 470 004 012</b>	<b>0 986 444 522</b>
2.4 TDE [00]	2,4	66	D2F... <PD24P>	01.00-07.06		<b>0 470 004 012</b>	<b>0 986 444 522</b>
		85	FXFA <DuraTorq DI>	03.04-07.06		<b>0 470 504 041</b>	<b>0 986 444 076</b>
		92	DOFA <PD24PP>	01.00-04.03		<b>0 470 504 018</b>	<b>0 986 444 078</b>
				05.03-07.06		<b>0 470 504 041</b>	<b>0 986 444 076</b>
<b>FT 350 L 2.0 TDE [00]</b>	2,0	74	ABFA <PD20>	08.03-07.06		<b>0 470 004 012</b>	<b>0 986 444 522</b>
2.4 TD [00]	2,4	55	F4FA <PD24N>	01.00-09.03		<b>0 470 004 012</b>	<b>0 986 444 522</b>
2.4 TDE [00]	2,4	66	D2F... <PD24P>	01.00-07.06		<b>0 470 004 012</b>	<b>0 986 444 522</b>
		85	FXFA <DuraTorq DI>	03.04-07.06		<b>0 470 504 041</b>	<b>0 986 444 076</b>
		88	D4FA <PD24>	01.00-04.03		<b>0 470 504 018</b>	<b>0 986 444 078</b>
				05.03-07.06		<b>0 470 504 041</b>	<b>0 986 444 076</b>
		92	DOFA <PD24PP>	01.00-04.03		<b>0 470 504 018</b>	<b>0 986 444 078</b>
				05.03-07.06		<b>0 470 504 041</b>	<b>0 986 444 076</b>
2.4 TDI [00]	2,4	66	<IDI24>	01.01-05.06	WEG	<b>0 460 414 219</b>	
		88/96	<IDI24>	01.01-05.06	WEG	<b>0 460 414 216</b>	
					WEG	<b>0 460 414 218</b>	
<b>FT 350 M 2.0 TDE [00]</b>	2,0	74	ABFA <PD20>	08.03-07.06		<b>0 470 004 012</b>	<b>0 986 444 522</b>
2.4 TD [00]	2,4	55	F4FA <PD24N>	01.00-09.03		<b>0 470 004 012</b>	<b>0 986 444 522</b>
2.4 TDE [00]	2,4	66	D2F... <PD24P>	01.00-07.06		<b>0 470 004 012</b>	<b>0 986 444 522</b>
		85	FXFA <DuraTorq DI>	03.04-07.06		<b>0 470 504 041</b>	<b>0 986 444 076</b>
		88	D4FA <PD24>	01.00-04.03		<b>0 470 504 018</b>	<b>0 986 444 078</b>
				05.03-07.06		<b>0 470 504 041</b>	<b>0 986 444 076</b>
		92	DOFA <PD24PP>	01.00-04.03		<b>0 470 504 018</b>	<b>0 986 444 078</b>
				05.03-07.06		<b>0 470 504 041</b>	<b>0 986 444 076</b>
2.4 TDI [00]	2,4	66	<IDI24>	01.01-05.06	WEG	<b>0 460 414 219</b>	
		88/96	<IDI24>	01.01-05.06	WEG	<b>0 460 414 216</b>	
					WEG	<b>0 460 414 218</b>	
<b>FT 430 E 2.4 TDI [00]</b>	2,4	96	<IDI24>	06.04-05.06	WEG	<b>0 460 414 216</b>	
					WEG	<b>0 460 414 218</b>	
<b>FT 430 EL 2.4 TD [00]</b>	2,4	55	F4FA <PD24N>	08.02-09.03		<b>0 470 004 012</b>	<b>0 986 444 522</b>
2.4 TDE [00]	2,4	66	D2F... <PD24P>	08.02-07.06		<b>0 470 004 012</b>	<b>0 986 444 522</b>
		85	FXFA <DuraTorq DI>	03.04-07.06		<b>0 470 504 041</b>	<b>0 986 444 076</b>
		92	DOFA <PD24PP>	08.02-04.03		<b>0 470 504 018</b>	<b>0 986 444 078</b>
				05.03-07.06		<b>0 470 504 041</b>	<b>0 986 444 076</b>
<b>FT 430 M 2.4 TD [00]</b>	2,4	55	F4FA <PD24N>	08.02-09.03		<b>0 470 004 012</b>	<b>0 986 444 522</b>
2.4 TDE [00]	2,4	85	FXFA <DuraTorq DI>	03.04-07.06		<b>0 470 504 041</b>	<b>0 986 444 076</b>
		92	DOFA <PD24PP>	08.02-04.03		<b>0 470 504 018</b>	<b>0 986 444 078</b>
				05.03-07.06		<b>0 470 504 041</b>	<b>0 986 444 076</b>





2.5 D 80-120, D 100 L, D 130-190 [86]	2,5	50-52	4... <D25N>; 4AB <D25N>; 4CA <D25N>	01.86-07.91	BO,TW	0 460 414 018	
						0 460 414 073	
DI LWB 100 L, DI SWB 80-120 [92]	2,5	52	4BC <D25N>; 4CC <D25N>	10.88-07.91	BO,TW	0 460 414 075	
				08.91-03.92		0 460 414 088	
DI LWB 100-190, DI SWB 80-150 [92]	2,5	59	4DA <D25P>		AGF	0 460 414 086	0 986 440 035
				04.92-07.94	AGF	0 460 414 089	
DI SWB 80-120 [92]	2,5	51-52	4FA <D25N>	08.91-07.94		0 460 414 083	
					AG	0 460 414 085	
<b>Transit Connect</b>							
1.8 TDDi [02]	1,8	55	BHPA <Euro3>; BHPB <93EEC>	05.02-06.10		0 470 004 008	0 986 444 521
<b>Transit Euroline</b>							
2.0 TDE [00]	2,0	74	ABFA <PD20>	08.00-07.06		0 470 004 012	0 986 444 522
2.5 D [95]	2,5	51	4FA <D25N>; 4FB <D25N>; 4FC <D25N>; 4FD <D25N>	08.94-07.95		0 460 414 113	0 986 440 043
				08.95-10.96	WEG	0 460 414 123	0 986 440 048
				08.96-08.97	WEG	0 460 414 153	0 986 440 219
				11.96-08.97	WEG	0 460 414 151	
				09.97-08.00	WEG	0 460 414 142	0 986 440 217
					WEG	0 460 414 141	0 986 440 052
DI [95]	2,5	56	4HB <D25P>; 4HC <D25P>	08.94-07.95		0 460 414 108	0 986 440 040
				08.95-10.96	WEG	0 460 414 119	0 986 440 046
				08.96-08.97	WEG	0 460 414 152	0 986 440 056
				11.96-08.97	WEG	0 460 414 150	0 986 440 055
				09.97-08.00	WEG	0 460 414 146	0 986 440 054
					WEG	0 460 414 145	0 986 440 053
<b>Transit Nugget</b>							
2.0 TDE [00]	2,0	74	ABFA <PD20>	08.00-07.06		0 470 004 012	0 986 444 522
2.5 D [95]	2,5	51	4FA <D25N>; 4FB <D25N>; 4FC <D25N>; 4FD <D25N>	08.94-07.95		0 460 414 113	0 986 440 043
				08.95-10.96	WEG	0 460 414 123	0 986 440 048
				08.96-08.97	WEG	0 460 414 153	0 986 440 219
				11.96-08.97	WEG	0 460 414 151	
				09.97-08.00	WEG	0 460 414 142	0 986 440 217
					WEG	0 460 414 141	0 986 440 052
DI [95]	2,5	56	4HB <D25P>; 4HC <D25P>	08.94-07.95		0 460 414 108	0 986 440 040
				08.95-10.96	WEG	0 460 414 119	0 986 440 046
				08.96-08.97	WEG	0 460 414 152	0 986 440 056
				11.96-08.97	WEG	0 460 414 150	0 986 440 055
				09.97-08.00	WEG	0 460 414 146	0 986 440 054
					WEG	0 460 414 145	0 986 440 053
<b>Transit Tourneo</b>							
2.0 TDE [00]	2,0	74	ABFA <PD20>	08.00-07.06		0 470 004 012	0 986 444 522
2.5 D [95]	2,5	51	4FA <D25N>; 4FB <D25N>; 4FC <D25N>; 4FD <D25N>	08.94-07.95		0 460 414 113	0 986 440 043
				08.95-10.96	WEG	0 460 414 123	0 986 440 048
				08.96-08.97	WEG	0 460 414 153	0 986 440 219
				11.96-08.97	WEG	0 460 414 151	
				09.97-08.00	WEG	0 460 414 142	0 986 440 217
					WEG	0 460 414 141	0 986 440 052
DI [95]	2,5	56	4HB <D25P>; 4HC <D25P>	08.94-07.95		0 460 414 108	0 986 440 040
				08.95-10.96	WEG	0 460 414 119	0 986 440 046
				08.96-08.97	WEG	0 460 414 152	0 986 440 056
				11.96-08.97	WEG	0 460 414 150	0 986 440 055
				09.97-08.00	WEG	0 460 414 146	0 986 440 054
					WEG	0 460 414 145	0 986 440 053

## GMC (GENERAL MOTORS CORP.)

## GMC

3500 HD	4,2	110	6.07T <Sprint 6.07T>	08.96-12.99	0 460 426 259
				01.00-12.01	0 460 426 331





**HYUNDAI**

**H 100**

2.5 Intercooler	2,5	57	D4BA	07.94-03.00	E96,TW	9 460 614 023
TCI	2,5	63	D4BF <4D56>	09.96-09.04	TW	9 460 614 023
		70	D4BH <2.5L-5D56 TCI>	10.04->		9 460 614 826
TD	2,5	59	D4BF	07.93-03.00	TW	9 460 614 023
				05.05->	TW	9 460 614 023
						9 460 614 199

**H-1**

2.5 TCI	2,5	73-74	D4BH <4D56>	07.01-01.04	GS,N14, WEG	9 460 614 002
---------	-----	-------	-------------	-------------	----------------	---------------

**Starex**

2.5 TCI	2,5	74	D4BH <4D56TC>	10.02-01.04	GS,N14, WEG	9 460 614 002
---------	-----	----	---------------	-------------	----------------	---------------

**ISUZU**

**Elf**

250 2.8 D	2,8	57	4JB1	10.86-12.96		9 461 619 347
-----------	-----	----	------	-------------	--	---------------

**Serie F**

FVZ1400T 9.8	9,8	199	6SD1TC-N	05.99->		9 400 612 913
--------------	-----	-----	----------	---------	--	---------------

**Serie N**

NHR 2.5 D	2,5	50	4JA1AG	12.87-12.95		9 460 610 323
-----------	-----	----	--------	-------------	--	---------------

NKR 2.8 D	2,8	57	4JB1	02.86-12.96		9 461 619 357
-----------	-----	----	------	-------------	--	---------------

NKR55L 2.8	2,8	67	4JB1-T	09.99-12.08		9 460 613 317
------------	-----	----	--------	-------------	--	---------------

						9 460 614 881
--	--	--	--	--	--	---------------

N250T 2.8 Carrier	2,8	67	4JB1-T	09.99-12.07		9 460 614 881
-------------------	-----	----	--------	-------------	--	---------------

**WFR, WFS**

2.0 D Turbo	2,0	52	4FC1T	05.86-12.96		9 460 610 183
-------------	-----	----	-------	-------------	--	---------------

						9 460 610 184
--	--	--	--	--	--	---------------

						9 460 610 185
--	--	--	--	--	--	---------------

						9 460 610 186
--	--	--	--	--	--	---------------

2.2 D	2,2	45	4FD1	02.83-12.93		9 460 610 153
-------	-----	----	------	-------------	--	---------------

				06.85-12.96		9 460 610 113
--	--	--	--	-------------	--	---------------

				05.86-12.96		9 460 610 198
--	--	--	--	-------------	--	---------------

						9 460 610 199
--	--	--	--	--	--	---------------

**IVECO**

**A**

55 -14	5,9	101	8060.05.246	12.88-12.91		0 460 416 042
--------	-----	-----	-------------	-------------	--	---------------

60 -9	3,9	65	8040.05.200	09.88-12.92		0 460 414 040
-------	-----	----	-------------	-------------	--	---------------

70 -14	5,9	101	8060.05.246	05.88-06.91		0 460 416 042
--------	-----	-----	-------------	-------------	--	---------------

79 -14	5,9	102	8060.05.285	07.88-12.92		0 460 416 042
--------	-----	-----	-------------	-------------	--	---------------

90 -14	5,9	101	8060.05.246	05.88-06.91		0 460 416 042
--------	-----	-----	-------------	-------------	--	---------------

**Daily**

A40 -8	2,5	55	8140.07.27...	07.89-04.96		0 460 414 067 0 986 440 028
--------	-----	----	---------------	-------------	--	-----------------------------

-10 Turbo	2,5	76	8140.27S.27...	09.89-04.96		0 460 414 054 0 986 440 027
-----------	-----	----	----------------	-------------	--	-----------------------------

			8140.27S.37...			
--	--	--	----------------	--	--	--

			Mot.Nr. ->2159632	09.89-04.96		0 460 414 103
--	--	--	-------------------	-------------	--	---------------

			Mot.Nr. 2159632->	09.89-04.96		0 460 414 122
--	--	--	-------------------	-------------	--	---------------

	2,8	76	8140.23.37... <Euro 2>	05.96-05.99		0 460 424 124 0 986 440 062
--	-----	----	------------------------	-------------	--	-----------------------------

-12 Turbo	2,8	90	8140.43.37... <Euro 2>	05.96-05.99		0 460 424 125 0 986 440 063
-----------	-----	----	------------------------	-------------	--	-----------------------------

			8140.43.3723 <Euro 2>	05.96-05.99	CSA,WEG	0 460 424 169
--	--	--	-----------------------	-------------	---------	---------------

A45 -10 Turbo	2,5	76	8140.27S.27...	07.89-04.96		0 460 414 054 0 986 440 027
---------------	-----	----	----------------	-------------	--	-----------------------------









			8140.27S.37...			
--	--	--	----------------	--	--	--

			Mot.Nr. ->2159632	09.89-04.96		0 460 414 103
--	--	--	-------------------	-------------	--	---------------

			Mot.Nr. 2159632->	09.89-04.96		0 460 414 122
--	--	--	-------------------	-------------	--	---------------

-10 Turbo [96]	2,8	76	8140.23.3721 <Euro 2>	05.96-05.99		0 460 424 124 0 986 440 062
----------------	-----	----	-----------------------	-------------	--	-----------------------------



									
		l/ccm	kW/(PS)	Typ					
<b>A45</b> -12 Turbo		2,5	85	8140.47S.2785					
				Mot.Nr. →1997701	10.90-04.96			<b>0 460 414 091</b>	
				Mot.Nr. 1997702→	10.90-04.96			<b>0 460 414 116</b>	
				8140.47.27...	06.90-04.96			<b>0 460 414 078</b>	<b>0 986 440 032</b>
				8140.47.37...					
				Mot.Nr. →1997701	06.90-04.96			<b>0 460 414 091</b>	
				Mot.Nr. 1997702→	06.90-04.96			<b>0 460 414 116</b>	
-12 Turbo [96]		2,8	90	8140.43.37... <Euro 2>	05.96-05.99			<b>0 460 424 125</b>	<b>0 986 440 063</b>
				8140.43.3723 <Euro 2>	05.96-05.99	CSA,WEG		<b>0 460 424 169</b>	
<b>A49</b> -10 Turbo [96]		2,8	76	8140.23.37... <Euro 2>	05.96-05.99			<b>0 460 424 124</b>	<b>0 986 440 062</b>
<b>29 L</b> 9 [00]		2,8	62	8140.63.4000	05.99-12.01			<b>0 460 494 471</b>	
11 [00]		2,8	78	8140.43C...	05.99-09.02			<b>0 460 424 177</b>	
<b>30</b> -8		2,5	55	8140.07.27...	02.91-04.96			<b>0 460 414 067</b>	<b>0 986 440 028</b>
				8140.07.371...	02.91-04.96			<b>0 460 414 109</b>	<b>0 986 440 041</b>
-8 [96]		2,5	60	8140.67F.37... <Euro 2>	05.96-03.98			<b>0 460 404 085</b>	
		2,8	62	8140.63.37... <Euro 2>	04.98-05.99			<b>0 460 494 464</b>	
-10 Turbo [96]		2,8	76	8140.23.37... <Euro 2>	05.96-05.99			<b>0 460 424 124</b>	<b>0 986 440 062</b>
				8140.23.3713 <Euro 2>	07.97-05.99	WEG		<b>0 460 424 170</b>	
<b>35</b> -8		2,5	55	8140.07.27...	02.91-04.96			<b>0 460 414 067</b>	<b>0 986 440 028</b>
				8140.07.37...	02.91-04.96			<b>0 460 414 109</b>	<b>0 986 440 041</b>
-8 [96]		2,5	60	8140.67F.37... <Euro 2>	05.96-03.98			<b>0 460 404 085</b>	
		2,8	62	8140.63.37... <Euro 2>	04.98-05.99			<b>0 460 494 464</b>	
-10 Turbo		2,5	66,1-68,9	8140.97.27...	07.91-04.96			<b>0 460 494 289</b>	
			76	8140.27S.27...	09.89-04.96			<b>0 460 414 054</b>	<b>0 986 440 027</b>
				8140.27S.37...					
				Mot.Nr. →2159632	09.89-04.96			<b>0 460 414 103</b>	
				Mot.Nr. 2159632→	09.89-04.96			<b>0 460 414 122</b>	
-10 Turbo [96]		2,5	80	8140.47R...					
				Mot.Nr. →1792114	07.92-04.97			<b>0 460 414 998</b>	
				Mot.Nr. 1792115→	07.92-04.97			<b>0 460 414 996</b>	<b>0 986 440 524</b>
		2,8	76	8140.23.37... <Euro 2>	05.96-05.99			<b>0 460 424 124</b>	<b>0 986 440 062</b>
				8140.23.3713 <Euro 2>	07.97-05.99	WEG		<b>0 460 424 170</b>	
-10 Turbo, -10 Turbo I.D.		2,5	77,5-83	8140.47B.37...; 8140.47R.2790					
				Mot.Nr. →1792114	07.92-04.97			<b>0 460 414 998</b>	
				Mot.Nr. 1792115→	07.92-04.97			<b>0 460 414 996</b>	<b>0 986 440 524</b>
-12 Turbo		2,5	85	8140.47S.2785					
				Mot.Nr. →1997701	10.90-04.96			<b>0 460 414 091</b>	
				Mot.Nr. 1997702→	10.90-04.96			<b>0 460 414 116</b>	
				8140.47.27...	10.90-04.96			<b>0 460 414 078</b>	<b>0 986 440 032</b>
				8140.47.37...					
				Mot.Nr. →1997701	10.90-04.96			<b>0 460 414 091</b>	
				Mot.Nr. 1997702→	10.90-04.96			<b>0 460 414 116</b>	
-12 Turbo [96]		2,8	90	8140.43.37... <Euro 2>	05.96-05.99			<b>0 460 424 125</b>	<b>0 986 440 063</b>
				8140.43.39... <Euro 2>		CSA,WEG		<b>0 460 424 169</b>	
				Mot.Nr. →2527005	05.96-05.99	CSA		<b>0 460 424 157</b>	
				Mot.Nr. 2527006→	05.96-05.99			<b>0 460 424 168</b>	
.10		2,8	76	8140.23 <ID/TCA>	11.97-05.02			<b>0 460 424 124</b>	<b>0 986 440 062</b>
					06.02-07.07			<b>0 460 424 243</b>	
.12		2,8	90	8140.43 <ID/TCA>	11.97-05.02			<b>0 460 424 125</b>	<b>0 986 440 063</b>
					06.02-07.07			<b>0 460 424 244</b>	
<b>35 C</b> 9 [00]		2,8	62	8140.63.40...	05.99-12.01			<b>0 460 494 471</b>	
11 [00]		2,8	78	8140.43C...	05.99-09.02			<b>0 460 424 177</b>	
<b>35 S</b> 9 [00]		2,8	62	8140.63.40...	05.99-12.01			<b>0 460 494 471</b>	
11 [00]		2,8	78	8140.43C...	05.99-03.02			<b>0 460 424 177</b>	
<b>40</b> -8		2,5	55	8140.07.27...	07.89-04.96			<b>0 460 414 067</b>	<b>0 986 440 028</b>
				8140.07.37...	07.89-04.96			<b>0 460 414 109</b>	<b>0 986 440 041</b>
-10 Turbo 4x4		2,5	76	8140.27S.28...	09.89-04.96			<b>0 460 414 054</b>	<b>0 986 440 027</b>
				8140.27S.3811					
				Mot.Nr. →2159632	09.89-04.96			<b>0 460 414 103</b>	
				Mot.Nr. 2159632→	09.89-04.96			<b>0 460 414 122</b>	
-10 Turbo 4x4 [96]		2,8	76	8140.23.3801 <Euro 2>	05.96-05.99			<b>0 460 424 124</b>	<b>0 986 440 062</b>





◀ IVECO

40	.10	2,5	76	8140.27S	11.97-12.01	0 460 424 124	0 986 440 062
	.12	2,8	76	8140.43	11.97-05.02	0 460 424 125	0 986 440 063
					06.02-07.07	0 460 424 244	
45	-10 Turbo	2,5	76	8140.27S.27... 8140.27S.37...	09.89-04.96	0 460 414 054	0 986 440 027
				Mot.Nr. →2159632	09.89-04.96	0 460 414 103	
				Mot.Nr. 2159632→	09.89-04.96	0 460 414 122	
49	-10 Turbo	2,5	76	8140.27S.27... 8140.27S.37...	09.89-04.96	0 460 414 054	0 986 440 027
				Mot.Nr. →2159632	09.89-04.96	0 460 414 103	
				Mot.Nr. 2159632→	09.89-04.96	0 460 414 122	
	-10 Turbo [96]	2,8	76	8140.23.37... <Euro 2>	05.96-05.99	0 460 424 124	0 986 440 062
				8140.23.3713 <Euro 2>	07.97-05.99 WEG	0 460 424 170	
	-10, -10 Turbo	2,5	77,5-83	8140.47B.37...; 8140.47R.27... Mot.Nr. →1792114	07.92-04.97	0 460 414 998	
				Mot.Nr. 1792115→	07.92-04.97	0 460 414 996	0 986 440 524
	-12 Turbo	2,5	85	8140.47S.2785 Mot.Nr. →1997701	10.90-04.96	0 460 414 091	
				Mot.Nr. 1997702→	10.90-04.96	0 460 414 116	
				8140.47.27...	06.90-04.96	0 460 414 078	0 986 440 032
				8140.47.37...			
				Mot.Nr. →1997701	06.90-04.96	0 460 414 091	
				Mot.Nr. 1997702→	06.90-04.96	0 460 414 116	
	-12 Turbo [96]	2,8	90	8140.43.37... <Euro 2>	05.96-05.99	0 460 424 125	0 986 440 063
					CSA,WEG	0 460 424 169	
	.12	2,8	90	8140.43	11.97-05.02	0 460 424 125	0 986 440 063
					06.02-07.07	0 460 424 244	
50 C 11 [00]		2,8	78	8140.43C...	05.99-09.02	0 460 424 177	
59	-12 Turbo	2,5	85	8140.47S.2785 Mot.Nr. →1997701	10.90-04.96	0 460 414 091	
				Mot.Nr. 1997702→	10.90-04.96	0 460 414 116	
				8140.47.27...	05.91-04.96	0 460 414 078	0 986 440 032
				8140.47.37...			
				Mot.Nr. →1997701	05.91-04.96	0 460 414 091	
				Mot.Nr. 1997702→	05.91-04.96	0 460 414 116	
	-12 Turbo [96]	2,8	90	8140.43.37... <Euro 2>	05.96-05.99	0 460 424 125	0 986 440 063
	.12	2,8	76	8140.43	11.97-05.02	0 460 424 125	0 986 440 063
					06.02-07.07	0 460 424 244	
60	.12	2,8	90	8140.43	10.02-07.07	0 460 424 125	0 986 440 063
<b>Daily, Grinta</b>							
30	-8	2,4	53	8140.61.2... Mot.Nr. →512798	04.78-06.89	0 460 494 024	
				Mot.Nr. 512799→	04.78-06.89	0 460 494 109	
	-10 Turbo	2,5	76,5	8140.27S.3... Mot.Nr. →2159632	02.85-06.89	0 460 414 103	
				Mot.Nr. 2159632→	02.85-06.89	0 460 414 122	
35	-8	2,4	53	8140.61.2... Mot.Nr. →512798	04.78-06.89	0 460 494 024	
				Mot.Nr. 512799→	04.78-06.89	0 460 494 109	
	-8 Duty	2,5	55	8140.07.27...	07.89-06.90	0 460 414 067	0 986 440 028
	-10 Turbo	2,4	67	8140.21.2...	02.85-06.89	0 460 414 008	0 986 440 023
		2,5	62	8140.27S.37... Mot.Nr. →2159632	02.85-06.89	0 460 414 103	
				Mot.Nr. 2159632→	02.85-06.89	0 460 414 122	
			70	8140.27R.27...	05.85-09.90	0 460 414 070	
40	-8	2,4	53	8140.61.2... Mot.Nr. →512798	01.83-06.89	0 460 494 024	
				Mot.Nr. 512799→	01.83-06.89	0 460 494 109	
	-10 Turbo 4x4	2,5	76	8140.27.2...	02.85-06.89	0 460 414 038	
45	-10 Turbo	2,4	67	8140.21.2...	02.85-06.89	0 460 414 008	0 986 440 023
49	-10 Turbo	2,4	67	8140.21.2... 8140.21.290	02.85-06.89	0 460 414 008	0 986 440 023
		2,5	70	8140.27R.27...	05.85-09.90	0 460 414 060	
						0 460 414 070	





EuroCargo						
<b>60 E 10</b>	4,0	75	8040.25B.42...		01.91-05.96	<b>0 460 424 077</b>
12	4,0	85	8040.25X.4...		01.91-05.96	<b>0 460 424 075</b>
14	4,0	100	8040.45X.4180		01.91-05.96	<b>0 460 424 086</b>
			8040.45.40...		01.91-05.96	<b>0 460 424 076</b>
<b>65 E 10</b>	4,0	75	8040.25B.42...		01.91-05.96	<b>0 460 424 077</b>
12	4,0	85	8040.25X.40...; 8040.25X.49...		01.91-05.96	<b>0 460 424 075</b>
			8040.45D...		06.96-07.00	<b>0 460 424 132</b>
14	4,0	100	8040.45.40...		01.91-06.96	<b>0 460 424 076</b>
			8040.45.5...		01.91-06.96	<b>0 460 424 110</b>
<b>75 E 12</b>	4,0	85	8040.25X.40...		01.91-05.96	<b>0 460 424 075</b>
			8040.45D.51...		01.94-08.00	<b>0 460 424 132</b>
14	4,0	100	8040.45X.4180 TCA		01.92-12.92	<b>0 460 424 086</b>
			8040.45.40...		01.91-12.93	<b>0 460 424 076</b>
			8040.45.5...		01.93-08.00	<b>0 460 424 110</b>
15	6,0	105	8060.25R.4...		01.91-12.92	<b>0 460 426 169</b>
			8060.45R.50...		01.93-08.00	<b>0 460 426 255</b>
<b>80 E 15</b>	6,0	105	8060.25R.42...		01.91-08.00	<b>0 460 426 169</b>
			8060.45R.50...		01.93-08.00	<b>0 460 426 255</b>
18	6,0	130	8060.25V.40...		01.91-08.00	<b>0 460 426 171 0 986 440 076</b>
			8060.45B.51...		09.91-07.00	<b>0 460 426 242</b>
21	6,0	152	8060.45X.4180		01.92-06.00	<b>0 460 426 198</b>
			8060.45.41...		01.91-08.00	<b>0 460 426 170</b>
			8060.45.4403		01.91-08.00	<b>0 460 426 215</b>
			8060.45.52...		01.91-08.00	<b>0 460 426 252</b>
<b>85 E 15</b>	6,0	105	8060.25R.49...		01.91-05.96	<b>0 460 426 169</b>
18	6,0	130	8060.25V.49...		01.91-08.00	<b>0 460 426 171 0 986 440 076</b>
			8060.45B.43...		09.91-07.00	<b>0 460 426 230</b>
			8060.45B.51...		09.91-07.00	<b>0 460 426 242</b>
<b>90 E 15</b>	6,0	105	8060.25R.47...		01.83-12.94	<b>0 460 426 169</b>
			8060.45R.50...		01.93-08.00	<b>0 460 426 255</b>
18	6,0	130	8060.45B.43...		09.91-07.00	<b>0 460 426 230</b>
			8060.45B.51...		09.91-07.00	<b>0 460 426 242</b>
21	6,0	152	8060.45.47...		01.91-12.00	<b>0 460 426 170</b>
			8060.45.52...		01.91-08.00	<b>0 460 426 252</b>
<b>100 E 15</b>	6,0	105	8060.25R.42...		01.91-08.00	<b>0 460 426 169</b>
			8060.45R.50...		01.91-08.00	<b>0 460 426 255</b>
18	6,0	130	8060.25V.40...		01.91-11.00	<b>0 460 426 171 0 986 440 076</b>
			8060.45B.51...		09.91-07.00	<b>0 460 426 242</b>
21	6,0	152	8060.45X.4180 TCA		01.92-11.00	<b>0 460 426 198</b>
			8060.45.41...		01.91-11.00	<b>0 460 426 170</b>
			8060.45.4403		01.91-08.00	<b>0 460 426 215</b>
			8060.45.52...		01.91-08.00	<b>0 460 426 252</b>
<b>120 E 15</b>	6,0	105	8060.25R.4...		12.91-07.00	<b>0 460 426 169</b>
			8060.45R.50...		12.91-07.00	<b>0 460 426 255</b>
18	6,0	130	8060.25V.4...		09.91-07.00	<b>0 460 426 171 0 986 440 076</b>
			8060.45B.51...		09.91-07.00	<b>0 460 426 242</b>
21	6,0	152	8060.45.52...		01.91-08.00	<b>0 460 426 252</b>
<b>130 E 15</b>	6,0	105	8060.25R.4...		02.92-07.00	<b>0 460 426 169</b>
			8060.45R.50...		12.91-07.00	<b>0 460 426 255</b>
18	6,0	130	8060.25V.4...		11.91-07.00	<b>0 460 426 171 0 986 440 076</b>
			8060.45B.51...		09.91-07.00	<b>0 460 426 242</b>
<b>135 E 18</b>	5,8	130	8060.25V.47...		01.94-07.00	<b>0 460 426 171 0 986 440 076</b>
			8060.45B.51...		01.94-07.00	<b>0 460 426 242</b>
<b>150 E 15</b>	6,0	105	8060.25R.4...		12.91-07.00	<b>0 460 426 169</b>
			8060.45R.50...		12.91-07.00	<b>0 460 426 255</b>
18	6,0	130	8060.25V.4...		09.91-07.00	<b>0 460 426 171 0 986 440 076</b>
			8060.45B.51...		09.91-07.00	<b>0 460 426 242</b>
21	6,0	152	8060.45.52...		01.91-08.00	<b>0 460 426 252</b>
<b>170 E 15</b>	6,0	105	8060.25R.436...		12.91-07.00	<b>0 460 426 169</b>
18	5,8	130	8060.25V.41...		01.94-07.00	<b>0 460 426 171 0 986 440 076</b>
	6,0	130	8060.45B.51...		09.91-07.00	<b>0 460 426 242</b>





◀ IVECO

<b>180 E 21</b>	6,0	152	8060.45.41...	04.92-07.00	<b>0 460 426 170</b>	
			8060.45.4403	04.92-07.00	<b>0 460 426 215</b>	
			8060.45.52...	04.92-07.00	<b>0 460 426 252</b>	
<b>Scudato</b>						
<b>35 .10</b>	2,8	76	8140.23 <ID/TCA>	01.99-12.03	<b>0 460 424 124</b>	<b>0 986 440 062</b>
<b>49 .12</b>	2,8	76	8140.43	11.99-05.02	<b>0 460 424 125</b>	<b>0 986 440 063</b>
<b>59 .12</b>	2,8	76	8140.43	06.02-09.05	<b>0 460 424 125</b>	<b>0 986 440 063</b>
<b>60 .12</b>	2,8	90	8140.43	10.02-09.03	<b>0 460 424 125</b>	<b>0 986 440 063</b>
<b>50</b>						
<b>50 -8</b>	3,7	63	8040.04.200	01.83-12.86	<b>0 460 314 033</b>	
-9	4,0	65	8040.05.230	01.87-06.91	<b>0 460 414 040</b>	
<b>60</b>						
<b>60 -11</b>	3,9	74	8040.25.230 R	01.87-05.91	<b>0 460 414 043</b>	
<b>65 -9</b>	3,9	65	8040.05.23...	01.87-12.92	<b>0 460 414 040</b>	
-12	3,9	85	8040.25.2...	01.87-12.92	<b>0 460 414 039</b>	
<b>70</b>						
<b>75 -13 W</b>	5,9	102	8060.05.270	07.87-12.92	<b>0 460 416 042</b>	
<b>79 -12</b>	3,9	85	8040.25.220	01.87-12.92	<b>0 460 414 039</b>	
-14	5,9	102	8060.05.28...	12.85-12.92	<b>0 460 416 042</b>	
<b>80</b>						
<b>80 -14 W</b>	5,9	102	8060.05.270	06.86-06.94	<b>0 460 416 042</b>	
<b>90</b>						
<b>95 -14</b>	5,9	102	8060.05.28...	11.85-05.91	<b>0 460 416 042</b>	
<b>100</b>						
<b>109 -14</b>	5,9	102	8060.05.286,288,289	11.85-06.91 TW	<b>0 460 416 042</b>	<b>0 460 416 063</b>
<b>110</b>						
<b>115 -14</b>	5,9	99-102	8060.05.20...	11.85-12.91	<b>0 460 416 042</b>	
<b>130</b>						
<b>130 -14</b>	5,9	102	8060.05.20...	11.85-12.91	<b>0 460 416 042</b>	
<b>300</b>						
<b>315 .8.18</b>	5,5	130	8060.25V.4600	06.91-11.00	<b>0 460 426 171</b>	<b>0 986 440 076</b>
			8060.45B.5160	06.91-11.00	<b>0 460 426 242</b>	
<b>316 .8.18</b>	5,5	130	8060.45B.5160	06.91-11.00	<b>0 460 426 242</b>	
<b>316.8.18</b>	5,5	130	8060.25V.4600	06.91-11.00	<b>0 460 426 171</b>	<b>0 986 440 076</b>

**LAZ**

**A191N**

<b>6.9</b>	6,9	206	D 0836 LOH02 <Euro 3>	01.08→	<b>0 470 506 009</b>	<b>0 986 444 010</b>
------------	-----	-----	-----------------------	--------	----------------------	----------------------

**LIAZ LIKINSKI (RUS)**

**Serie 6000**

<b>6213</b>	6,9	206	D0836L0H02 <Euro 3>	09.08→	<b>0 986 444 010</b>	<b>0 986 444 010</b>
-------------	-----	-----	---------------------	--------	----------------------	----------------------

**MAHINDRA**

**Bolero Camper**

<b>2.5 D</b>	2,5	43	MDI 3200 D	06.03-11.03	<b>0 460 414 209</b>	
				12.03→	<b>0 460 414 231</b>	
		74	NEF TCI	10.04→	<b>0 460 414 240</b>	
D 4WD	2,5	46	MDI 3200 TC	07.05-05.07	<b>0 460 414 231</b>	
4WD [India 2000]	2,5	43	MDI 3200 A	06.03-06.05	<b>0 460 414 197</b>	





MAN

Ale						
	4,6		D 0834 LOH01 <V5101, Euro 3>	02.00-12.01		<b>0 470 504 017 0 986 444 090</b>
Bus 8t						
<b>8.136</b> FAE, FOC	5,7	100	D 0226 MF	03.82-01.86		<b>0 460 416 009</b>
				06.83-08.86	12V	<b>0 460 416 028</b>
				02.86-08.88		<b>0 460 416 056</b>
<b>8.150</b> FAE, FOC	6,9	110	D 0826 GF03 <Z8300, Euro 1>	10.92-05.95		<b>0 460 416 070</b>
FOC	6,9	110-114	D 0826 GF01 <Z8300>	07.88-02.89		<b>0 460 426 104</b>
				07.88-10.93	EFV	<b>0 460 416 069</b>
FOC, FOCL	4,6	114-118	D 0824 LFO01 <V1700, Euro 2>	02.95-07.98		<b>0 460 424 104</b>
<b>8.160</b> FOC, FOCL	4,6	114-118	D 0824 LFL09 <V1700, Euro 2>	07.98-02.01		<b>0 460 424 150</b>
<b>8.170</b> FOC	5,7	125-131	D 0226 MCFO; D 0226 MCFO/170	09.85-10.93		<b>0 460 426 036</b>
<b>8.220</b> FOC, FOCL	6,9	162	D 0826 LFL10 <V2300, Euro 2>	07.98-09.01	MVR	<b>0 460 426 273</b>
Bus 9t						
<b>9.136</b> FAE, FOC	5,7	100	D 0226 MF	03.82-01.86		<b>0 460 416 009</b>
				06.83-08.86	12V	<b>0 460 416 028</b>
				02.86-08.88		<b>0 460 416 056</b>
<b>9.150</b> FAE, FOC	6,9	110	D 0826 GF03 <Z8300, Euro 1>	10.92-05.95		<b>0 460 416 070</b>
FOC	6,9	110-114	D 0826 GF01 <Z8300>	07.88-02.89		<b>0 460 426 104</b>
				07.88-10.93	EFV	<b>0 460 416 069</b>
<b>9.170</b> FOC	5,7	125-131	D 0226 MCFO; D 0226 MCFO/170	09.85-10.93		<b>0 460 426 036</b>
Bus 10t						
<b>10.150</b> FOC [L2000]	4,6	114-118	D 0824 LFO-01 <V1700, Euro 2>	02.95-01.96		<b>0 460 424 104</b>
HOCL	6,9	110-114	D 0826 OH02 <Z9300>	01.88-05.92	MRQ	<b>0 460 416 072</b>
					MVR	<b>0 460 416 073</b>
<b>10.180</b> HOCL	6,9	130-137	D 0826 TOH01 <Z8600>	01.88-05.92	MVR	<b>0 460 426 112</b>
<b>10.220</b> FOC, FOCL [L2000]	6,9	162	D 0826 LFL10 <V2300, Euro 2>	07.98-09.01	MVR	<b>0 460 426 273</b>
Bus 11t						
<b>11.150</b> HOCL	6,9	110-114	D 0826 OH02 <Z9300>	05.92-02.93	MRQ	<b>0 460 416 072</b>
					MVR	<b>0 460 416 073</b>
<b>11.190</b> HOCL	6,9	140	D 0826 LOH02 <V0900, Euro 2>	04.92-02.93	MRQ	<b>0 460 426 202</b>
					MVR	<b>0 460 426 194</b>
			D 0826 LOH06 <V0900, Euro 1>	03.93-09.96		<b>0 460 426 231</b>
					MVR	<b>0 460 426 209</b>
<b>11.220</b> HOCL	6,9	162	D 0826 LOH19 <V2900, Euro 2>	07.98-09.01	MRQ	<b>0 460 426 281</b>
					MVR	<b>0 460 426 273</b>
			D 0836 LOH03 <V4900, Euro 3>	01.01-12.04		<b>0 470 506 019 0 986 444 077</b>
Bus 12t						
<b>12.170</b> FOC, FOCL	5,7	125	D 0226 MKF/170	03.85-04.90		<b>0 460 426 028</b>
<b>12.220</b> HOCL [M2000 LE]	6,9	162	D 0836 LFL02 <V3900, Euro 3>	09.02→		<b>0 470 506 019 0 986 444 077</b>
HOCL-NL	6,9	162	D 0826 LOH19 <V2900, Euro 2>	07.98-09.02	MRQ	<b>0 460 426 281</b>
					MVR	<b>0 460 426 273</b>
HOCL-NL, HOCL-SR	6,9	162	D 0836 LOH03 <V4900, Euro 3>	04.99-09.06		<b>0 470 506 019 0 986 444 077</b>
<b>12.280</b> HOCL-NL	6,9	206	D 0836 LOH02 <V4900, Euro 3>	01.01-09.02		<b>0 470 506 009 0 986 444 010</b>
Bus 13t						
<b>13.220</b> HOCL	6,9	162	D 0836 LOH03 <V4900, Euro 3>	09.01-05.04		<b>0 470 506 019 0 986 444 077</b>
Bus 14t						
<b>14.170</b> FOC	5,7	125	D 0226 MKF/170	04.85-04.90		<b>0 460 426 028</b>
<b>14.192</b> FOC	5,7	141	D 0226 MKF	04.85-03.90		<b>0 460 426 032</b>
<b>14.220</b> HOCL-NL	6,9	162	D 0826 LOH19 <V2900, Euro 2>	07.98-09.01	MRQ	<b>0 460 426 281</b>
					MVR	<b>0 460 426 273</b>
			D 0836 LOH03 <V4900, Euro 3>	01.01-09.06		<b>0 470 506 019 0 986 444 077</b>
		206	D 0836 LOH02 <V4900, Euro 3>	01.02-09.02		<b>0 470 506 009 0 986 444 010</b>
<b>14.280</b> HOCL-SR	6,9	206	D 0836 LOH02 <V4900, Euro 3>	06.03-10.06		<b>0 470 506 009 0 986 444 010</b>
Bus 17t						
<b>17.192</b> GM2	6,9	140	D 0826 LF05 <Z9500, Euro 1>	10.92-05.94		<b>0 460 426 194</b>
Bus 18t						
<b>LE 232</b> FOC [M2000 LE]	6,9	162	D 0826 LFL10 <V2300, Euro 2>	08.00→	MVR	<b>0 460 426 273</b>





◀ MAN

<b>18.220</b> HOCL-NL	6,9	162	D 0826 LOH19 <V2900, Euro 2>	07.98-09.01	MRQ	<b>0 460 426 281</b>	
					MVR	<b>0 460 426 273</b>	
			D 0836 LOH03 <V4900, Euro 3>	01.01-09.06		<b>0 470 506 019</b>	<b>0 986 444 077</b>
<b>18.232</b> FOC/HOC [M2000]	6,9	162	D 0826 LFL10 <V2300, Euro 2>	03.97→	MVR	<b>0 460 426 273</b>	
<b>18.280</b> HOCL-NL	6,9	206	D 0836 LOH02 <V4900, Euro 3>	01.01-09.06		<b>0 470 506 009</b>	<b>0 986 444 010</b>
<b>EL / EM</b>							
<b>EM 192</b> [469]	6,9	140	D 0826 LOH06 <V0900, Euro 1>	10.93-06.97		<b>0 460 426 231</b>	
					MVR	<b>0 460 426 209</b>	
<b>EM 220</b> [469]	6,9	162	D 0836 LOH03 <V4900, Euro 3>	11.99-12.04		<b>0 470 506 019</b>	<b>0 986 444 077</b>
<b>F/M/U 90</b>							
<b>24.192</b> FNL	6,9	140	D 0826 LFO7 <Z9500, Euro 1>	05.94-03.96		<b>0 460 426 209</b>	
FNL, FVL	6,9	140	D 0826 LFO1 <Z9500>	07.89-10.92		<b>0 460 426 182</b>	
			D 0826 LFO5 <Z9500, Euro 1>	10.92-05.94		<b>0 460 426 194</b>	
FVL	6,9	140	D 0826 LFO7 <Z9500, Euro 1>	05.94-03.96		<b>0 460 426 209</b>	
				04.96-06.96		<b>0 460 426 258</b>	
<b>Lion's City / NL</b>							
<b>NL 223</b> [A21]	6,9	162	D 0836 LUH02 <V4600, Euro 3>	01.01-06.05		<b>0 470 506 019</b>	<b>0 986 444 077</b>
F [A22]	6,9	162	D 0836 LUH02 <V4600, Euro 3>	01.01-09.06		<b>0 470 506 019</b>	<b>0 986 444 077</b>
<b>NL 283</b> [A21]	6,9	206	D 0836 LUH01 <V4600, Euro 3>	01.01-09.06		<b>0 470 506 009</b>	<b>0 986 444 010</b>
F [A22]	6,9	206	D 0836 LUH01 <V4600, Euro 3>	01.01-09.06		<b>0 470 506 009</b>	<b>0 986 444 010</b>
<b>Lion's City M / NM</b>							
[A47]	6,9	162	D 0836 LOH03 <V4900, Euro 3>	04.04-09.06		<b>0 470 506 019</b>	<b>0 986 444 077</b>
<b>NM 152</b> [A05]	4,6	114	D 0824 LOH01 <V1900, Euro 1>	08.91-05.96	MRQ	<b>0 460 424 104</b>	
					MVR	<b>0 460 424 101</b>	
<b>NM 223</b> F [A35]	6,9	162	D 0836 LOH03 <V4900, Euro 3>	01.00-09.06		<b>0 470 506 019</b>	<b>0 986 444 077</b>
<b>NM 283</b> F [A35]	6,9	206	D 0836 LOH02 <V4900, Euro 3>	10.01-09.06		<b>0 470 506 009</b>	<b>0 986 444 010</b>
<b>Lion's City T,TÜ / EL</b>							
[A78]	6,9	162	D 0836 LOH03 <V4900, Euro 3>	06.04-09.06		<b>0 470 506 019</b>	<b>0 986 444 077</b>
		206	D 0836 LOH02 <V4900, Euro 3>	06.04-09.06		<b>0 470 506 009</b>	<b>0 986 444 010</b>
<b>Lion's City Ü / NÜ</b>							
<b>NÜ 283</b> [A20]	6,9	206	D 0836 LUH01 <V4600, Euro 3>	01.01-09.06		<b>0 470 506 009</b>	<b>0 986 444 010</b>
<b>Lion's Classic / SL</b>							
<b>SL 223</b> [A74]	6,9	162	D 0836 LOH03 <V4900, Euro 3>	06.03-10.06		<b>0 470 506 019</b>	<b>0 986 444 077</b>
<b>SL 283</b> [A74]	6,9	206	D 0836 LOH02 <V4900, Euro 3>	06.03-09.06		<b>0 470 506 009</b>	<b>0 986 444 010</b>
<b>L2000</b>							
<b>8.103</b> F, FL, L, LL	4,6	75	D 0824 FLO1 <V1800, Euro 1>	10.93-06.96		<b>0 460 404 080</b>	
<b>8.113</b> L, LL	4,6	83	D 0824 LFL08 <V1700, Euro 2>	03.97-09.01		<b>0 460 424 153</b>	
<b>8.153</b> F, FL	4,6	114	D 0824 LFL01 <V1700, Euro 1>	10.93-02.95	MVR	<b>0 460 424 101</b>	
L, LA, LL	4,6	114	D 0824 LFL05 <V1700, Euro 1>	08.95-07.97		<b>0 460 424 123</b>	
LA, LL	4,6	114	D 0824 LFL01 <V1700, Euro 1>	01.95-02.95	MVR	<b>0 460 424 101</b>	
				03.95-12.95	MVR	<b>0 460 424 117</b>	
<b>8.163</b> L, LA, LL	4,6	114	D 0824 LFL09 <V1700, Euro 2>	03.97-02.02		<b>0 460 424 150</b>	
<b>8.185</b> L, LL	4,6	132	D 0834 LFL03 <V4400, Euro 3>	09.00-08.02		<b>0 470 504 017</b>	<b>0 986 444 090</b>
<b>8.224</b> L, LC, LK, L-KI, LK-LV, LLC, LLS	6,9	162	D 0826 LFL10 <V2300, Euro2>	07.94-09.01	MVR	<b>0 460 426 273</b>	
<b>9.153</b> F, FL	4,6	114	D 0824 LFL01 <V1700, Euro 1>	10.93-02.95	MVR	<b>0 460 424 101</b>	
L, LL	4,6	114	D 0824 LFL05 <V1700, Euro 1>	08.95-06.96		<b>0 460 424 123</b>	
LL	4,6	114	D 0824 LFL01 <V1700, Euro 1>	01.95-02.95	MVR	<b>0 460 424 101</b>	
				03.95-12.95	MVR	<b>0 460 424 117</b>	
<b>9.163</b> L, LL	4,6	114	D 0824 LFL09 <V1700, Euro 2>	03.97-09.01		<b>0 460 424 150</b>	
<b>9.185</b> L	4,6	132	D 0834 LFL03 <V4400, Euro 3>	09.00-08.02		<b>0 470 504 017</b>	<b>0 986 444 090</b>
<b>9.224</b> LC, L-KI, LLC, LLS	6,9	162	D 0826 LFL10 <V2300, Euro2>	07.94-09.01	MVR	<b>0 460 426 273</b>	
LK, LK-LV	0,0	162	D 0826 LFL10 <V2300, Euro2>	07.94-09.01	MVR	<b>0 460 426 273</b>	
<b>10.145</b> L	4,6	103	D 0834 LFL02 <V4400, Euro 3>	07.01-06.02		<b>0 470 504 017</b>	<b>0 986 444 090</b>
<b>10.153</b> F, FL	4,6	114	D 0824 LFL01 <V1700, Euro 1>	10.93-02.95	MVR	<b>0 460 424 101</b>	
L, LA, LL	4,6	114	D 0824 LFL01 <V1700, Euro 1>	01.95-02.95	MVR	<b>0 460 424 101</b>	
				03.95-12.95	MVR	<b>0 460 424 117</b>	
			D 0824 LFL05 <V1700, Euro 1>	08.95-06.96		<b>0 460 424 123</b>	
<b>10.160</b> LA	4,6	114	D 0824 LFL09 <V1700, Euro 2>	03.97-09.06		<b>0 460 424 150</b>	
<b>10.163</b> L, LA, LL	4,6	114	D 0824 LFL09 <V1700, Euro 2>	03.97→		<b>0 460 424 150</b>	
<b>10.224</b> F, FL, LA, LC, LK, LK-L	6,9	162	D 0826 LFL10 <V2300, Euro 2>; D 0826 LFL10 <V2300, Euro2>	07.98-12.06	MVR	<b>0 460 426 273</b>	
<b>12.163</b> L, LL	4,6	114	D 0824 LFL09 <V1700, Euro 2>	03.97-08.01		<b>0 460 424 150</b>	
<b>12.224</b> L, LL	6,9	162	D 0826 LFL10 <V2300, Euro 2>	03.97-09.01	MVR	<b>0 460 426 273</b>	





14.163 L, LL	4,6	114	D 0824 LFL09 <V1700, Euro 2>	03.97-08.01		0 460 424 150
14.224 L, LA, LL	6,9	162	D 0826 LFL10 <V2300, Euro 2>	03.97-09.01	MVR	0 460 426 273
15.163 L, LL	4,6	114	D 0824 LFL09 <V1700, Euro 2>	03.97-09.01		0 460 424 150
15.224 L, LL	6,9	162	D 0826 LFL10 <V2300, Euro 2>; D 0826 LF10 <V2300, Euro 2>	03.97→	MVR	0 460 426 273
18.224 L, LA, LL	6,9	162	D 0826 LFL10 <V2300, Euro 2>	03.97-09.01	MVR	0 460 426 273
20.224 L, LL	6,9	162	D 0826 LFL10 <V2300, Euro 2>	10.97-09.01	MVR	0 460 426 273
<b>L2000 Evol. (LE)</b>						
8.140 F, FL	4,6	103	D 0834 LFL02 <V4400, Euro 3>	09.02-08.04		0 470 504 017 0 986 444 090
8.150 F, FL	4,6	110	D 0834 LFL04 <V4400, Euro 3>	06.04-12.05		0 470 504 017 0 986 444 090
8.180 F, FL	4,6	132	D 0834 LFL03 <V4400, Euro 3>	09.02-12.05		0 470 504 017 0 986 444 090
8.220 F, FL	6,9	162	D 0836 LFL02 <V3900, Euro 3>	09.02-12.05		0 470 506 019 0 986 444 077
9.140 F, FL	4,6	103	D 0834 LFL02 <V4400, Euro 3>	09.02-08.04		0 470 504 017 0 986 444 090
9.150 F, FL	4,6	110	D 0834 LFL04 <V4400, Euro 3>	06.04-06.05		0 470 504 017 0 986 444 090
9.180 F, FL	4,6	132	D 0834 LFL03 <V4400, Euro 3>	09.02-06.05		0 470 504 017 0 986 444 090
9.220 F, FL	6,9	162	D 0836 LFL02 <V3900, Euro 3>	09.02-06.05		0 470 506 019 0 986 444 077
10.150 F, FL	4,6	110	D 0834 LFL04 <V4400, Euro 3>	06.04-06.05		0 470 504 017 0 986 444 090
10.180 F, FA, F, FL	4,6	132	D 0834 LFL03 <V4400, Euro 3>	09.02-10.06		0 470 504 017 0 986 444 090
10.220 F, FA, F, FL	6,9	162	D 0836 LFL02 <V3900, Euro 3>	09.02-12.06		0 470 506 019 0 986 444 077
140C F, FL	4,6	103	D 0834 LFL02 <V4400, Euro 3>	07.01-08.02		0 470 504 017 0 986 444 090
180C F, FA, F, FL	4,6	132	D 0834 LFL03 <V4400, Euro 3>	09.00-08.02		0 470 504 017 0 986 444 090
220C F, FA, F, FL	6,9	162	D 0826 LFL10 <V2300, Euro 2>	09.00-01.02	MVR	0 460 426 273
			D 0836 LFL02 <V3900, Euro 3>	07.01-08.02		0 470 506 019 0 986 444 077
<b>Midi Beta</b>						
11.190 HOCL	6,9	140	D 0826 LOH06 <V0900, Euro 1>	03.93-09.95		0 460 426 231
					MVR	0 460 426 209
<b>M2000</b>						
12.163 L	4,6	114	D 0824 LFL09 <V1700, Euro 2>	03.00-12.01		0 460 424 150
12.224 M, ML	6,9	162	D 0826 LF18 <V3000, Euro 2>	03.97-09.01	MVR	0 460 426 273
12.255 MC, MLS	6,9	180	D 0836 LF05 <V4000, Euro 3>	01.01-08.02		0 470 506 009 0 986 444 010
12.284 MC, MLC, MLS	6,9	206	D 0836 LF01 <V4000, Euro 2>	06.98-09.01		0 470 506 009 0 986 444 010
12.285 MC	6,9	206	D 0836 LF03 <V4000, Euro 3>	01.01-09.01		0 470 506 009 0 986 444 010
14.224 M, MA, ML	6,9	162	D 0826 LF18 <V3000, Euro 2>	03.97-09.01	MVR	0 460 426 273
14.284 LA-AF, LAC, LAK, LC, LRC, LK, LRK, LLC, LLLC, MAK, MA-KO, MA-LF, MC, MLC, MLLC, MLS	6,9	206	D 0836 LFL01 <V3900, Euro 2>; D 0836 LF01 <V4000, Euro 2>	06.98-09.01		0 470 506 009 0 986 444 010
15.284 LC, LK-LV, LLC, LLLC	6,9	206	D 0836 LFL01 <V3900, Euro 2>	06.98-09.01		0 470 506 009 0 986 444 010
18.224 LS, AK, LA, M, MA, ML, MLLC	6,9	162	D 0826 LFL10 <V2300, Euro 2>; D 0826 LF18 <V3000, Euro 2>	03.97→	MVR	0 460 426 273
18.284 LAC, LAK-LV, LC, LK-LV, L-KO, LLC, LLK, LLLC, MAC, MAK, MAK-LV, MC, MK-LV, M-KO, MLK, MLLC, MLS	6,9	206	D 0836 LFL01 <V3900, Euro 2>; D 0836 LF01 <V4000, Euro 2>	06.98-09.01		0 470 506 009 0 986 444 010
20.284 LNLC, LNLLC	6,9	206	D 0836 LFL01 <V3900, Euro 2>	05.99-09.01		0 470 506 009 0 986 444 010
25.224 M, ML, MVL	6,9	162	D 0826 LF15 <V3000, Euro 2>; D 0826 LF18 <V3000, Euro 2>	08.95-09.01	MVR	0 460 426 273
25.264 ML	6,9	191	D 0826 LF17 <V3000, Euro 2>	08.95-01.01	MVR	0 460 426 273
25.284 MNLC, MNLLC, MVLC	6,9	206	D 0836 LF01 <V4000, Euro 2>	06.98-09.01		0 470 506 009 0 986 444 010
26.225 DLK	6,9	119	D 0836 LFL02 <V3900, Euro 3>	01.99-06.02		0 470 506 019 0 986 444 077
26.255 DLK	6,9	180	D 0836 LFL05 <V3900, Euro 3>	01.99-06.02		0 470 506 009 0 986 444 010
26.284 DL	6,9	206	D 0836 LFL01 <V3900, Euro 2>	01.99-09.01		0 470 506 009 0 986 444 010
26.285 DLK, DL-TM	6,9	206	D 0836 LFL03 <V3900, Euro 3>	01.99-12.02		0 470 506 009 0 986 444 010
<b>M2000 Evol. (LE)</b>						
12.180 F, FL	4,6	132	D 0834 LFL03 <V4400, Euro 3>	09.02-12.05		0 470 504 017 0 986 444 090
12.220 F, FL	6,9	162	D 0836 LFL02 <V3900, Euro 3>	09.02-06.06		0 470 506 019 0 986 444 077
12.250 F, FL	6,9	180	D 0836 LFL05 <V3900, Euro 3>	09.02-06.06		0 470 506 009 0 986 444 010
12.280 F, FL	6,9	206	D 0836 LFL03 <V3900, Euro 3>	09.02-06.06		0 470 506 009 0 986 444 010
14.220 F, FL	6,9	162	D 0836 LFL02 <V3900, Euro 3>	09.02-06.06		0 470 506 019 0 986 444 077
14.225 F, FA	6,9	162	D 0836 LFL02 <V3900, Euro 3>	09.02-09.06		0 470 506 019 0 986 444 077
14.250 F, FL	6,9	180	D 0836 LFL05 <V3900, Euro 3>	09.02-06.06		0 470 506 009 0 986 444 010
14.255 F, FA	6,9	180	D 0836 LFL05 <V3900, Euro 3>	09.02-09.06		0 470 506 009 0 986 444 010
14.280 F, FL	6,9	206	D 0836 LFL03 <V3900, Euro 3>	09.02-06.06		0 470 506 009 0 986 444 010
14.285 F, FA	6,9	206	D 0836 LFL03 <V3900, Euro 3>	09.02-09.06		0 470 506 009 0 986 444 010
15.180 F, FL	4,6	132	D 0834 LFL03 <V4400, Euro 3>	09.02-03.05		0 470 504 017 0 986 444 090





◀ MAN

15.220 F, FL	6,9	162	D 0836 LFL02 <V3900, Euro 3>	09.02-09.06	0 470 506 019	0 986 444 077
15.250 F, FL	6,9	180	D 0836 LFL05 <V3900, Euro 3>	09.02-09.06	0 470 506 009	0 986 444 010
15.280 F, FL	6,9	206	D 0836 LFL03 <V3900, Euro 3>	09.02-09.06	0 470 506 009	0 986 444 010
18.220 F, FA, F, FL	6,9	162	D 0836 LFL02 <V3900, Euro 3>	09.02-09.06	0 470 506 019	0 986 444 077
18.250B F, FA, F, FL	6,9	180	D 0836 LFL05 <V3900, Euro 3>; D 0836 LF05 <V4000, Euro 3>	09.02-09.06	0 470 506 009	0 986 444 010
18.280 F, FA, F, FL	6,9	206	D 0836 LFL03 <V3900, Euro 3>	09.02-09.06	0 470 506 009	0 986 444 010
20.220 DF	6,9	162	D 0836 LFL02 <V3900, Euro 3>	09.02-09.06	0 470 506 019	0 986 444 077
20.250 DF	6,9	180	D 0836 LFL05 <V3900, Euro 3>	09.02-09.06	0 470 506 009	0 986 444 010
20.280 DF	6,9	206	D 0836 LFL03 <V3900, Euro 3>	09.02-09.06	0 470 506 009	0 986 444 010
180B F, FL	4,6	132	D 0834 LFL03 <V4400, Euro 3>	07.01-08.02	0 470 504 017	0 986 444 090
180C F, FL	4,6	132	D 0834 LFL03 <V4400, Euro 3>	07.01-09.02	0 470 504 017	0 986 444 090
220B DF, F, FA, F, FL	6,9	162	D 0836 LFL02 <V3900, Euro 3>	07.01-09.02	0 470 506 019	0 986 444 077
DF, F, FL	6,9	162	D 0826 LFL10 <V2300, Euro 2>	08.00-09.01	MVR	0 460 426 273
220C F, FL	6,9	162	D 0836 LFL02 <V3900, Euro 3>	07.01-08.02	0 470 506 019	0 986 444 077
250B DF, F, FA, F, FL	6,9	180	D 0836 LFL05 <V3900, Euro 3>; D 0836 LF05 <V4000, Euro 3>	07.01-09.02	0 470 506 009	0 986 444 010
280B DF, F, FA, F, FL	6,9	206	D 0836 LFL03 <V3900, Euro 3>; D 0836 LF01 <V4000, Euro 2>	09.00-09.02	0 470 506 009	0 986 444 010

**M2000 Evol. (ME)**

12.220 F, FL	6,9	162	D 0836 LF04 <V4000, Euro 3>	09.02-07.05	0 470 506 019	0 986 444 077
12.250 F, FL	6,9	180	D 0836 LF05 <V4000, Euro 3>	09.02-07.05	0 470 506 009	0 986 444 010
12.280 F, FL	6,9	206	D 0836 LF03 <V4000, Euro 3>	09.02-07.05	0 470 506 009	0 986 444 010
14.220 F, FA, F, FL	6,9	162	D 0836 LF04 <V4000, Euro 3>	09.02-07.05	0 470 506 019	0 986 444 077
14.250 F, FA, F, FL	6,9	180	D 0836 LFL05 <V3900, Euro 3>; D 0836 LF05 <V4000, Euro 3>	09.02-07.05	0 470 506 009	0 986 444 010
14.280 F, FA, F, FL	6,9	206	D 0836 LFL03 <V3900, Euro 3>	09.02-07.05	0 470 506 009	0 986 444 010
18.220 F, FA, F, FL	6,9	162	D 0836 LF04 <V4000, Euro 3>	09.02-07.05	0 470 506 019	0 986 444 077
18.250 F, FA, F, FL	6,9	180	D 0836 LFL05 <V3900, Euro 3>	09.02-07.05	0 470 506 009	0 986 444 010
18.280 F, FA, F, FL	6,9	206	D 0836 LFL03 <V3900, Euro 3>	09.02-07.05	0 470 506 009	0 986 444 010
25.250 DF	6,9	180	D 0836 LF05 <V4000, Euro 3>	09.02-07.05	0 470 506 009	0 986 444 010
25.280 DF	6,9	206	D 0836 LF03 <V4000, Euro 3>	09.02-07.05	0 470 506 009	0 986 444 010
220B DF, F, FL	6,9	162	D 0826 LF18 <V3000, Euro 2>	09.00-09.01	MVR	0 460 426 273
F, FA, F, FL	6,9	162	D 0836 LF04 <V4000, Euro 3>	09.00-08.02	0 470 506 019	0 986 444 077
250B DF, F, FA, F, FL	6,9	180	D 0836 LFL05 <V3900, Euro 3>; D 0836 LF05 <V4000, Euro 3>	06.01-09.02	0 470 506 009	0 986 444 010
280B DF, F, FA, F, FL	6,9	206	D 0836 LFL03 <V3900, Euro 3>; D 0836 LF01 <V4000, Euro 2>; D 0836 LF03 <V4000, Euro 3>	08.00-09.02	0 470 506 009	0 986 444 010

**SL**

223 F	6,9	162	D 0836 LOH03 <V4900, Euro 3>	06.04-09.06	0 470 506 019	0 986 444 077
283 F	6,9	206	D 0836 LOH02 <V4900, Euro 3>	06.04-09.06	0 470 506 009	0 986 444 010

**SM**

152 MIDI	6,9	110-114	D 0826 OH02 <Z9300>	11.87-04.94	MRQ	0 460 416 072
					MVR	0 460 416 073
182 MIDI	6,9	130-137	D 0826 TOH01 <Z8600>	11.87-04.92	MVR	0 460 426 112
192 MIDI	6,9	140	D 0826 LOH01 <V0900, Euro 1>	04.92-02.95		0 460 426 182

**SÜ**

223	6,9	162	D 0826 LOH19 <V2900, Euro 2>	11.99-09.01	MRQ	0 460 426 281
					MVR	0 460 426 273
F	6,9	162	D 0836 LOH03 <V4900, Euro 3>	06.04-09.06		0 470 506 019
283 F	6,9	206	D 0836 LOH02 <V4900, Euro 3>	06.04-09.06		0 470 506 009









**6t**

6.100 F	4,6	75	D 0824 GF, GF01 <Z8200>			
			Mot.Nr. GF→	09.87-12.92		0 460 424 040
			Mot.Nr. GF01→	09.87-12.92		0 460 404 069
			D 0824 GF02 <Z8200, Euro 1>	10.92-10.93		0 460 404 072
6.90 F	3,8	66	D 0224 MF			
			Mot.Nr. ...5282001...→	04.86-09.87		0 460 404 045

**8t**

8.100 F	4,6	75	D 0824 GF, GF01 <Z8200>			
			Mot.Nr. GF→	09.87-12.92		0 460 424 040
			Mot.Nr. GF01→	09.87-12.92		0 460 404 069
			D 0824 GF02 <Z8200, Euro 1>	10.92-10.93		0 460 404 072



											
<b>8.136 F, FL</b>	5,7	100	D 0226 MF		11.80-01.86		<b>0 460 416 009</b>				
					06.83-08.86	12V	<b>0 460 416 028</b>				
					02.86-09.87		<b>0 460 416 056</b>				
<b>8.150 F, FAE, FL</b>	6,9	110-114	D 0826 GF <Z8300>		09.87-02.89		<b>0 460 426 104</b>				
					09.87-12.92	FMN	<b>0 460 426 191</b>				
					03.89-12.92		<b>0 460 426 134</b>				
					F, FAKO, FL	6,9	110	D 0826 GF03 <Z8300, Euro 1>	10.92-05.95		<b>0 460 416 070</b>
					F, FL	5,7	92	D 0226 MF/Silent	05.90-10.93		<b>0 460 416 056</b>
<b>8.90 F</b>	3,8	66	D 0224 MF		Mot.Nr. ...5282001....->	04.86-09.87	<b>0 460 404 045</b>				
<b>9t</b>											
<b>9.136 F, FL</b>	5,7	100	D 0226 MF		11.80-01.86		<b>0 460 416 009</b>				
					06.83-08.86	12V	<b>0 460 416 028</b>				
					02.86-09.87		<b>0 460 416 056</b>				
<b>9.150 F, FAE, FL</b>	6,9	110-114	D 0826 GF <Z8300>		09.87-02.89		<b>0 460 426 104</b>				
					09.87-12.92	FMN	<b>0 460 426 191</b>				
					03.89-12.92		<b>0 460 426 134</b>				
					F, FAKO, FL	6,9	110	D 0826 GF03 <Z8300, Euro 1>	10.92-05.95		<b>0 460 416 070</b>
					F, FL	5,7	92	D 0226 MF/Silent	05.90-10.93		<b>0 460 416 056</b>
<b>10t</b>											
<b>10.136 F, FL</b>	5,7	100	D 0226 MF		09.81-01.86		<b>0 460 416 009</b>				
					06.83-08.86	12V	<b>0 460 416 028</b>				
					02.86-09.87		<b>0 460 416 056</b>				
<b>10.150 F, FL</b>	5,7	92	D 0226 MF/Silent		05.90-10.93		<b>0 460 416 056</b>				
					6,9	110	D 0826 GF03 <Z8300, Euro 1>	10.92-10.93		<b>0 460 416 070</b>	
					110-114	D 0826 GF01 <Z8300>	09.87-02.89		<b>0 460 426 104</b>		
					09.87-12.92	EFV	<b>0 460 416 069</b>				
<b>12t</b>											
<b>12.136 F, FL, FR</b>	5,7	100	D 0226 MF		09.83-01.88		<b>0 460 416 031</b>				
<b>12.152 F, FL</b>	4,6	114	D 0824 LF01 <V2700, Euro 1>		05.94-06.97		<b>0 460 424 101</b>				
						12V	<b>0 460 424 117</b>				
						24V	<b>0 460 424 134</b>				
	6,9	110	D 0826 F02 <V0200, Euro 1>		10.92-05.94		<b>0 460 416 073</b>				
		110-114	D 0826 F01 <V0200>		12.88-10.92		<b>0 460 416 068</b>				
<b>12.170 F, FL, FR</b>	5,7	125	D 0226 MKF/170		04.83-02.89		<b>0 460 426 028</b>				
<b>12.192 F, FA, FL</b>	6,9	140	D 0826 LF05 <Z9500, Euro 1>		10.92-05.94		<b>0 460 426 194</b>				
					D 0826 LF07 <Z9500, Euro 1>	05.94-03.96		<b>0 460 426 209</b>			
						04.96-06.96		<b>0 460 426 258</b>			
					F, FL	6,6	137	D 0826 TF <Z9400>	08.88-06.90		<b>0 460 426 112</b>
						6,9	140	D 0826 LF01 <Z9500>	07.90-10.92		<b>0 460 426 182</b>
F, FL, FR	5,7	141	D 0226 MKF		09.83-02.89		<b>0 460 426 032</b>				
<b>14t</b>											
<b>14.136 F, FL, FR</b>	5,7	100	D 0226 MF		09.83-02.89		<b>0 460 416 031</b>				
<b>14.152 F, FL</b>	4,6	114	D 0824 LF01 <V2700, Euro 1>		05.94-06.97		<b>0 460 424 101</b>				
						12V	<b>0 460 424 117</b>				
						24V	<b>0 460 424 134</b>				
	6,9	110	D 0826 F02 <V0200, Euro 1>		12.91-05.94		<b>0 460 416 073</b>				
		110-114	D 0826 F01 <V0200>		12.88-12.91		<b>0 460 416 068</b>				
<b>14.170 F, FA, FL, FR</b>	5,7	125	D 0226 MKF/170		04.83-07.89		<b>0 460 426 028</b>				
<b>14.192 F, FA, FL, FR</b>	5,7	141	D 0226 MKF		09.83-07.89		<b>0 460 426 032</b>				
					F, FL	6,6	137	D 0826 TF <Z9400>	08.88-06.90		<b>0 460 426 112</b>
						6,9	140	D 0826 LF01 <Z9500>	07.90-10.92		<b>0 460 426 182</b>
								D 0826 LF05 <Z9500, Euro 1>	10.92-05.94		<b>0 460 426 194</b>
			D 0826 LF07 <Z9500, Euro 1>	05.94-03.96		<b>0 460 426 209</b>					
					04.96-06.96		<b>0 460 426 258</b>				
<b>16t</b>											
<b>16.136 F, FL</b>	5,7	100	D 0226 MF		04.84-11.86		<b>0 460 416 031</b>				
<b>16.170 F, FA, FL</b>	5,7	125	D 0226 MKF/170		03.84-11.86		<b>0 460 426 028</b>				
<b>16.192 F, FA, FL</b>	5,7	141	D 0226 MKF		03.84-11.86		<b>0 460 426 032</b>				
<b>17t</b>											
<b>17.136 F, FL, FR, FRL</b>	5,7	100	D 0226 MF		11.86-08.88		<b>0 460 416 031</b>				
<b>17.170 F, FA, FL, FR, FRL</b>	5,7	125	D 0226 MKF/170		11.86-07.89		<b>0 460 426 028</b>				





◀ MAN

<b>17.192 F</b> , FA, FL	6,6	137	D 0826 TF <Z9400>	08.88-06.90	<b>0 460 426 112</b>	
	6,9	140	D 0826 LF01 <Z9500>	07.90-04.95	<b>0 460 426 182</b>	
	F, FA, FL, FR	5,7	141	D 0226 MKF	11.86-07.89	<b>0 460 426 032</b>
	FA	6,9	140	D 0826 LF07 <Z9500, Euro 1>	05.94-03.96	<b>0 460 426 209</b>
					04.96-06.96	<b>0 460 426 258</b>
FA, FL	6,9	140	D 0826 LF05 <Z9500, Euro 1>	10.92-05.95	<b>0 460 426 194</b>	
<b>18t</b>						
<b>18.192 F</b>	6,9	140	D 0826 LF07 <Z9500, Euro 1>	05.94-03.96	<b>0 460 426 209</b>	
				04.96-06.96	<b>0 460 426 258</b>	
	F, FL	6,9	140	D 0826 LF01 <Z9500>	09.90-05.94	<b>0 460 426 182</b>
			D 0826 LF05 <Z9500, Euro 1>	10.92-05.94	<b>0 460 426 194</b>	
<b>24t</b>						
<b>24.192 FVL</b> , FVL-KO	5,7	141	D 0226 MKF	05.87-12.90	<b>0 460 426 032</b>	

**MAZDA**

<b>Pickup B</b>					
<b>2.2</b>	2,2	52	S2	08.81-10.87	<b>9 460 610 180</b>
				05.83-10.87	<b>9 460 610 172</b>
					<b>9 460 610 216</b>
<b>Serie E</b>					
<b>2.2 D</b>	2,2	44	R2		
			Fg.Nr. SDY021503584→	02.84-08.88	<b>9 460 610 306</b>
				KZO	<b>9 460 610 191</b>
			Fg.Nr. →SDY021503584	02.84-08.88	<b>9 460 610 144</b>
				KZO	<b>9 460 610 145</b>
			R254		
			Fg.Nr. SDY021503584→	11.85-02.88	<b>9 460 610 306</b>
				KZO	<b>9 460 610 191</b>
			Fg.Nr. →SDY021503584	11.85-02.88	<b>9 460 610 144</b>
				KZO	<b>9 460 610 145</b>
			46 R207	01.84-02.88	HL <b>9 460 610 342</b>
			Fg.Nr. SDY021503584→	01.84-02.88	<b>9 460 610 306</b>
		Fg.Nr. →SDY021503584	01.84-02.88	<b>9 460 610 144</b>	
D, D 4WD	2,2	44-47	R281; R284; R286; R293; R294; R296	12.87-04.97	HL <b>9 460 610 308</b>
				NOR	<b>9 460 610 306</b>
<b>T</b>					
<b>2.5 D</b>	2,5	52	XA	12.86-05.87	<b>9 460 610 320</b>
				06.87-12.92	<b>9 460 610 293</b>
<b>3.0</b>	3,0	50-66	HA	06.76-12.86	<b>9 460 610 022</b>
				07.80-12.86	<b>9 460 610 094</b>
				08.81-12.86	<b>9 460 610 213</b>
				05.86-12.86	24V <b>9 460 610 182</b>
		66	HA	06.87-12.97	<b>9 460 610 295</b>

**MERCEDES-BENZ**

<b>Sprinter</b>					
<b>210 D [T1N]</b>	2,9	75	OM 602.980 DE LA	01.97-03.00	FE2 <b>0 460 415 982 0 986 440 525</b>
			Mot.Nr. →..000136	01.97-03.00	AG,FE2 <b>0 460 415 995 0 986 440 533</b>
			Mot.Nr. →..009849	01.97-03.00	FE2,GS <b>0 460 415 995 0 986 440 533</b>
			Mot.Nr. ..000137→	01.97-03.00	AG,FE2 <b>0 460 415 992 0 986 440 531</b>
			Mot.Nr. ..009850→	01.97-03.00	FE2,GS <b>0 460 415 992 0 986 440 531</b>
<b>212 D [T1N]</b>	2,9	90	OM 602.980 DE LA	02.95-03.00	FE2 <b>0 460 415 982 0 986 440 525</b>
			Mot.Nr. →..000136	02.95-03.00	AG,FE2 <b>0 460 415 995 0 986 440 533</b>
			Mot.Nr. →..009849	02.95-03.00	FE2,GS <b>0 460 415 995 0 986 440 533</b>
			Mot.Nr. ..000137→	02.95-03.00	AG,FE2 <b>0 460 415 992 0 986 440 531</b>
			Mot.Nr. ..009850→	02.95-03.00	FE2,GS <b>0 460 415 992 0 986 440 531</b>
<b>310 D</b>	2,5	70	OM 014 A <(632.999)>	09.96-05.01	<b>0 460 414 160</b>





<b>310 D</b> , D James Cook [T1N]	2,9	75	OM 602.980 DE LA	01.97-03.00	FE2	<b>0 460 415 982</b>	<b>0 986 440 525</b>
			Mot.Nr. →..000136	01.97-03.00	AG,FE2	<b>0 460 415 995</b>	<b>0 986 440 533</b>
			Mot.Nr. →..009849	01.97-03.00	FE2,GS	<b>0 460 415 995</b>	<b>0 986 440 533</b>
			Mot.Nr. ..000137→	01.97-03.00	AG,FE2	<b>0 460 415 992</b>	<b>0 986 440 531</b>
			Mot.Nr. ..009850→	01.97-03.00	FE2,GS	<b>0 460 415 992</b>	<b>0 986 440 531</b>
<b>312 D</b>	2,5	77	OM 014 LA <Euro 2 (632.997)>	10.99-05.01		<b>0 460 414 202</b>	
		85	OM 014 LA <Euro 2 (632.998)>	08.99-05.01		<b>0 460 414 198</b>	
D, D James Cook [T1N]	2,9	90	OM 602.980 DE LA	02.95-03.00	FE2	<b>0 460 415 982</b>	<b>0 986 440 525</b>
			Mot.Nr. →..000136	02.95-03.00	AG,FE2	<b>0 460 415 995</b>	<b>0 986 440 533</b>
			Mot.Nr. →..009849	02.95-03.00	FE2,GS	<b>0 460 415 995</b>	<b>0 986 440 533</b>
			Mot.Nr. ..000137→	02.95-03.00	AG,FE2	<b>0 460 415 992</b>	<b>0 986 440 531</b>
			Mot.Nr. ..009850→	02.95-03.00	FE2,GS	<b>0 460 415 992</b>	<b>0 986 440 531</b>
<b>410 D</b> [T1N]	2,9	75	OM 602.980 DE LA	01.97-03.00	FE2	<b>0 460 415 982</b>	<b>0 986 440 525</b>
			Mot.Nr. →..000136	01.97-03.00	AG,FE2	<b>0 460 415 995</b>	<b>0 986 440 533</b>
			Mot.Nr. →..009849	01.97-03.00	FE2,GS	<b>0 460 415 995</b>	<b>0 986 440 533</b>
			Mot.Nr. ..000137→	01.97-03.00	AG,FE2	<b>0 460 415 992</b>	<b>0 986 440 531</b>
			Mot.Nr. ..009850→	01.97-03.00	FE2,GS	<b>0 460 415 992</b>	<b>0 986 440 531</b>
<b>412 D</b>	2,5	85	OM 014 LA <Euro 2>	10.99-05.01		<b>0 460 414 198</b>	
D [T1N]	2,9	90	OM 602.980 DE LA	02.95-03.00	FE2	<b>0 460 415 982</b>	<b>0 986 440 525</b>
			Mot.Nr. →..000136	02.95-03.00	AG,FE2	<b>0 460 415 995</b>	<b>0 986 440 533</b>
			Mot.Nr. →..009849	02.95-03.00	FE2,GS	<b>0 460 415 995</b>	<b>0 986 440 533</b>
			Mot.Nr. ..000137→	02.95-03.00	AG,FE2	<b>0 460 415 992</b>	<b>0 986 440 531</b>
			Mot.Nr. ..009850→	02.95-03.00	FE2,GS	<b>0 460 415 992</b>	<b>0 986 440 531</b>

**Unimog**

<b>U 90, 100 L</b>	2,9	90	OM 602.981,989 turbo; OM 602.981,989 turbo <LEV>				
			Mot.Nr. →..045121	07.96-09.01	TW	<b>0 460 415 988</b>	<b>0 986 440 527</b>
			Mot.Nr. ..044336→..044336 ..045122→ ..045360 ..045371→	07.96-09.01	FE2,TW	<b>0 460 415 982</b>	<b>0 986 440 525</b>

**UX**

<b>100</b>	2,9	80	OM 602.989 DE 29 LA <Euro 2>	08.96→		<b>0 460 415 988</b>	<b>0 986 440 527</b>
------------	-----	----	------------------------------	--------	--	----------------------	----------------------

**Vario**

<b>O 812</b> [T2W]	2,9	90	OM 602... <Euro 2>	09.96-01.01	EU2	<b>0 460 415 988</b>	<b>0 986 440 527</b>
					FE2	<b>0 460 415 982</b>	<b>0 986 440 525</b>
<b>512 D</b> [T2W]	2,9	90	OM 602.984 LA <Euro 2>	09.96-01.01	EU2	<b>0 460 415 988</b>	<b>0 986 440 527</b>
					FE2	<b>0 460 415 982</b>	<b>0 986 440 525</b>
<b>612 D</b> [T2W]	2,9	90	OM 602.984,985 LA <Euro 2>	09.96-01.01	EU2	<b>0 460 415 988</b>	<b>0 986 440 527</b>
					FE2	<b>0 460 415 982</b>	<b>0 986 440 525</b>
<b>812 D</b> [T2W]	2,9	90	OM 602.984,985 LA <Euro 2>	09.96-09.06	EU2	<b>0 460 415 988</b>	<b>0 986 440 527</b>
					FE2	<b>0 460 415 982</b>	<b>0 986 440 525</b>

**MITSUBISHI**

**Canter**

<b>2.4 D Turbo</b>	2,4	70	4D55T	05.84-12.94		<b>9 460 610 045</b>	
<b>Canter 35</b>							
<b>2.3 D</b> [FB]	2,3	49	4D55	01.86-01.90		<b>9 460 610 095</b>	
<b>2.5 D</b> [FB]	2,5	51	4D56	02.90-01.91		<b>9 460 610 505</b>	
				CH 01.86-01.90		<b>9 460 610 432</b>	
				02.91-09.96		<b>9 460 610 537</b>	
				CH 01.86-09.96		<b>9 460 610 505</b>	
<b>2.8 D Turbo</b> [FB]	2,8	85	4M40	05.98-10.00		<b>9 460 614 113</b>	
D Turbo Interc. [FE]	2,8	85	4M40	05.98-10.00		<b>9 460 614 113</b>	
<b>3C 11</b> [FB]	3,0	81	4M42 <Euro 3>	01.05-03.06		<b>0 470 504 027</b>	
<b>3S 11</b> [FE]	3,0	81	4M42 <Euro 3>	01.05-03.06		<b>0 470 504 027</b>	
<b>3.0 D Turbo</b> [FB]	3,0	92	4M42	11.00-02.05		<b>0 470 504 027</b>	
D Turbo Interc. [FE]	3,0	92	4M42-OAT	11.00-02.05		<b>0 470 504 027</b>	
<b>Canter 55</b>							
<b>3.0 D Turbo</b> Interc. [FE]	3,0	92	4M42-OAT	11.00-02.05		<b>0 470 504 027</b>	
<b>5S 13</b> [FE]	3,0	92	4M42-3A T1 <Euro 3>	01.05-03.06		<b>0 470 504 027</b>	
<b>L 200</b>							
<b>2.5 D Turbo</b>	2,5	64	4D56	08.97-12.03	TW	<b>9 460 613 400</b>	<b>9 460 614 159</b>





◀ MITSUBISHI

<b>L 300</b>							
2.5 D Turbo	2,5	74	4D56		08.98-12.03	9 460 610 776	
<b>L 300 Truck</b>							
2.3 D [L]	2,3	49-50	4D55		06.84-10.86	9 460 610 168	
2.5 D [L]	2,5	52	4D56		11.86-10.89	9 460 610 396	
					11.89-10.90	9 460 610 577	
					11.90-05.94	9 460 610 578	
				D Turbo [P]	06.94-12.01	ABS	9 460 610 696
					AGF	9 460 613 168	
					ABS	9 460 610 695	
<b>L 300 Van</b>							
2.3 D [L]	2,3	49-50	4D55		06.84-10.86	9 460 610 168	
2.5 D Turbo 4WD [P]	2,5	62-64	4D56		11.88-10.89	9 460 610 522	
					11.89-12.91	9 460 610 582	
					01.92-12.01	9 460 610 583	
				D 2WD [P]	11.86-10.89	KZØ	9 460 610 397
						KZO	9 460 610 398
			11.89-10.90	KZØ	9 460 610 560		
				KZO	9 460 610 580		
			11.90-12.91	KZØ	9 460 610 508		
				KZO	9 460 610 528		
			01.92-06.95	KZØ	9 460 610 579		
				KZO	9 460 610 581		
			07.95-12.00		9 460 610 683		

**MULTICAR**

<b>M25</b>						
1.9 4x4	1,9	40	1Y <028.B>		01.91-12.92 TW	0 460 484 139
						0 460 484 140
<b>M26</b>						
1.9 4x4	1,9	40	1Y <028.B>		07.92-12.96	0 460 484 139

**NISSAN**

<b>Cabstar</b>						
2.0 D Turbo [F22]	2,0	60	LD20T		05.84-06.92	9 460 610 027
					05.86-06.92	9 460 610 204
2.3 D [F22]	2,3	54	SD23		12.81-06.92	9 460 610 005
					05.82-06.92	9 460 610 007
2.5 D [F22]	2,5	57	SD25		01.82-06.92	9 460 610 006
D [F23]	2,5	59	TD25		07.92-05.94 TW	9 460 610 430
						9 460 610 445
						9 460 614 524
				A	06.94-05.96	9 460 611 213
				CH	06.94-05.96	9 460 613 019
			A,CH	06.94-05.96	9 460 610 725	
<b>Cabstar ZZ</b>						
4.6	4,6	90	FD46		11.99→	9 400 610 551
						9 410 610 415
<b>Frontier</b>						
2.7 D	2,7	65-66	TD27		05.00-10.00	9 460 611 507
					11.00-08.01	9 460 613 548
					09.01→	9 460 614 018
<b>L50</b>						
4.0 D	4,0	66	B440II		02.93-12.03	0 460 424 099
<b>L60</b>						
4.0 D	4,0	66	B4II		06.94-12.04	0 460 424 108
			B440II		02.93-12.03	0 460 424 099
<b>M</b>						
5.9 D	5,9	110	B660TII		03.93-12.08	0 460 426 221







**Trade**

3.0 D	3,0	63	BD30	04.93-12.98	9 460 610 633
-------	-----	----	------	-------------	---------------

**Urvan**

2.3 D [E23]	2,3	51	SD23	04.82-02.87 AGF	9 460 610 281
				03.85-01.87	9 460 610 137
				HL	9 460 610 280
				KZO	9 460 610 282
D [E24]	2,3	53	TD23	02.87-10.87 AG	9 460 610 241
				02.87-12.88 KZO	9 460 610 240
				11.87-01.88	9 460 610 416
				11.87-12.88 AG	9 460 610 735
				HL	9 460 610 732
				02.88-12.88	9 460 610 341
		55	TD23	11.86-03.89	9 460 610 243
2.5 D [E24]	2,5	59	TD25	12.88-10.93 AG	9 460 610 352
				A,D 12.88-07.94 AGF	9 460 610 351
				CH 12.88-10.93	9 460 610 564
				11.93-05.97	9 460 610 734
				CH 12.88-09.90	9 460 610 414
				10.90-10.93	9 460 610 588
				11.93-07.94	9 460 610 414
				08.94-10.95	9 460 610 713
				11.95-05.97	9 460 610 733

**Vanette**

2.0 D	2,0	48	LD20	09.84-07.89	9 460 610 076
					9 460 610 128
D [C120]	2,0	48-49	LD20	08.84-06.87	9 460 610 520
D [C220]	2,0	44	LD20II	04.87-11.94	9 460 610 504
		47-49	LD20IIL	12.87-03.88	9 460 610 605
				04.88-11.94	9 460 610 524
D [GC22]	2,0		LD20	10.87-08.91	9 460 610 393
		47-49	LD20	09.86-08.91	9 460 610 393
				09.91-03.93	9 460 610 592

**Vanette Cargo**

2.0 D [C23M]	2,0	49	LD20	07.92-05.93 AGF	9 460 610 568
				AGF	9 460 610 569
				06.93-09.94 AGF	9 460 610 635
				AGF	9 460 610 684
2.3 D [C23M]	2,3	55	LD23	09.94-10.95	0 460 494 403
				11.95-06.96 AGF,WEG	0 460 494 403
				AGF,TW	0 460 494 355
				11.95-03.98 AGF,WEG	0 460 494 404
				07.96-03.98 TW,WEG	0 460 494 355
				04.98-07.99 AGF,WEG	0 460 494 461
				AGF,TW	0 460 494 465
				AGF,WEG	0 460 494 469
				AGF,TW	0 460 494 468
				08.99-11.01	0 460 494 461



**Bedford-Blitz**

2.3 D CF	2,3	46	23 D <OHC>	07.83-07.87	0 460 494 126
----------	-----	----	------------	-------------	---------------

**Euromidi**

2.0 DT	2,0	51	4 FC1T	09.88-08.96 DKF	9 460 610 354
2.2 D	2,2	45	4 FD1	09.88-08.96 DKF	9 460 610 353
2.4 DT	2,4	56	4 FG1T	09.88-08.96 DKF	9 460 610 795





**PAZ PAVLOVO**

Serie 3000						
3204	3,9	104	4BTAA 3.9-140 <Euro 2>		01.00→	0 460 424 226
3205	3,9	103	EQB-140-20 <Euro 2>		01.00→	0 460 414 217

**PEUGEOT**

Boxer						
1.9 D [U3]	1,9	50	DJY <XUD9A>		07.98-02.02 BOW	0 460 484 070
					WZT	0 460 484 146
					02.94-10.94 BOW	0 460 484 054
					02.94-05.98 BOW	0 460 484 091
					11.94-02.02 BOW,EFV	0 460 484 064 0 986 440 094
D Turbo [U3]	1,9	66	DHX <XUD9TE>		06.98-02.02 EFV,WZT	0 460 484 111
					02.94-12.95 BOW	0 460 494 341
					02.94-02.02 N05,WZT	0 460 494 430
					N11,WZT	0 460 494 383
					01.96-02.02 BOW,EFV	0 460 494 423 0 986 440 156
2.5 D [U3]	2,5	63	T9A <DJ5>		02.94-11.94 BOW	0 460 494 342
					02.94-02.02 WZT	0 460 494 388
					12.94-02.02 BOW,EFV	0 460 494 370
					05.98-02.02 N05,WZT	0 460 494 460
					02.94-02.97 BOW,N03	0 460 494 337 0 986 440 146
Tdi [U3]	2,5	79-81	THX <DJ5TED>		03.97-05.98 BOW,N03	0 460 494 429
					10.96-02.02 BOW	0 460 414 140 0 986 440 051
					WZT	0 460 414 156
2.8 D	2,8	66			03.02-08.05	0 460 494 483
					D [U3]	2,8 64 8140 63 <SOFIM 2800>
J 5						
1.9 D	1,9	51	D9B <XUD9A>		11.87-04.88 B0	0 460 494 222
					05.88-12.93 B0	0 460 494 240

**RENAULT**

B							
70	2,5	53	8140.61.235		01.83-12.90	0 460 494 109	
80 Messenger	2,5	55	8140.07.2585 <Euro 1>		07.94-07.96	0 460 414 109 0 986 440 041	
			8140.67.2585 <Euro 2>		06.96-06.99	0 460 404 088	
			56 8140.07.2530 ID		08.90-06.94	0 460 414 067 0 986 440 028	
90	2,5	68-71	8140.21.235 IDS		01.86-06.94	0 460 414 008 0 986 440 023	
			4x2, 4x4	8140.27.2582; 8140.27.2582 IDS		06.86-07.96	0 460 414 076
110 Messenger 4x2	2,5	78	8140.27.2530 IDS		08.90-06.94	0 460 414 054 0 986 440 027	
			Messenger 4x2, Messenger 4x4	8140.27.2565 IDS; 8140.27.2585 <Euro 1>		10.93-08.96	0 460 414 102
				8140.23.2565; 8140.23.2585 <Euro 2>		06.96-06.99	0 460 424 136 0 986 440 064
120 Messenger	2,5	85	8140.47.2530 IDR		10.91-06.94	0 460 414 078 0 986 440 032	
				8140.47.2585 <Euro 1>		07.94-07.96	0 460 414 121
				8140.43.2585 <Euro 2>		06.96-06.01	0 460 424 137
				2,8 90 8140.43.2585 <Euro 2>		06.96-06.01	0 460 424 137
				Messenger 4x2, Messenger 4x4	2,5 85 8140.47.2590 <Euro 1>		07.94-09.95
JE							
13	5,5	113	798-20				
			Mot.Typ 798-20		01.85-09.86	0 460 316 020	
JK							
60 B	3,6	67	720-12		10.79-01.86	0 460 304 197	
65	3,6	66	720-12		10.79-01.86	0 460 304 197	
75	3,6	66	720-12		10.79-01.86	0 460 304 197	
Mascott							
90	2,8	63	8140.63.2585		01.99-06.04	0 460 494 464	
			8140.63.2586		01.99-06.04	0 460 494 470	





<b>Master</b>						
<b>P28 -35D</b>	2,4	52	8140.61.2300			
			Mot.Nr. 344483->	10.82-11.90		<b>0 460 494 109</b>
<b>T28 -35</b>	2,4	55	8140.67.2560 <S8U 748>	01.94-09.97		<b>0 460 404 082</b>
	2,5	69	8140.27.2590 <S9U 740>	01.94-09.97		<b>0 460 414 996 0 986 440 524</b>
-35D	2,4	52-55	8140.61.2300 <S8U 731>			
			Mot.Nr. 344483->	10.82-09.97		<b>0 460 494 109</b>
		55	8140.67.2510 <S8U 742>	09.80-09.97		<b>0 460 494 340</b>
	2,5	69	8140.27.2500,2510 <S9U 700>	09.80-09.97		<b>0 460 414 068</b>
			8140.27.2510 <S9U 704>; 8140.27.2512 <S9U 704>	09.80-09.97		<b>0 460 414 081 0 986 440 033</b>
			8140.27.2560 <S9U 714>	01.94-09.97		<b>0 460 414 112 0 986 440 042</b>
		72	8140.27.2580 <S9U 702>	09.80-09.97		<b>0 460 414 076</b>
<b>1.9 dTi 80 [X70]</b>	1,9	58	F9Q 770	01.00-09.03		<b>0 460 414 988 0 986 440 520</b>
<b>2.5 D [X70]</b>	2,5	60	S8U 770 <8140,67.2620/29>	10.97-09.03	<del>KL</del>	<b>0 460 404 090</b>
					KL	<b>0 460 404 093</b>
			S8U 772	10.97-09.03	KL	<b>0 460 404 097</b>
<b>2.8 D [X70]</b>	2,8	86	S8W 700	05.01-10.04		<b>0 460 494 484</b>
DTI	2,8	84	8140 TCA	01.02-09.04		<b>0 460 424 250</b>
dTi 110 [X70]	2,8	81	S9W 700 <Sofim8140.43,2609/39>	10.97-06.00		<b>0 460 424 148</b>
dTi 120 [X70]	2,8	84	S9W 702 <Sofim8140.43,2620/29>	10.97-06.00	<del>KL</del>	<b>0 460 424 147 0 986 440 066</b>
					KL	<b>0 460 424 146 0 986 440 065</b>
<b>S</b>						
<b>90</b>	3,6	67	720.12.01	05.84-06.91		<b>0 460 304 197</b>
<b>110 Midliner</b>	5,5	76	797-21	06.85-09.90		<b>0 460 306 266</b>
<b>120 Midliner</b>	4,0	82	Phaser 110 T <T4.40 A/3, Euro 1>	06.93-06.96		<b>0 460 424 097</b>
			Phaser 110 T <T4.40 CC>	09.90-06.93		<b>0 460 424 052</b>
<b>130 Midliner</b>	5,5	96-97	797.20	05.83-03.90		<b>0 460 306 139</b>
<b>135 Midliner</b>	4,0	102	Phaser 110 T <T4.40 B/3, Euro 1>	02.94-05.96		<b>0 460 424 100</b>
<b>150</b>	5,5	113	798-10	05.83-07.86		<b>0 460 316 020</b>
<b>SG</b>						
<b>2</b>	3,3	54	712-01-03	10.79-09.86		<b>0 460 304 140</b>
					AG	<b>0 460 304 161</b>
<b>3</b>	3,3	53	712-01-03	10.79-09.86		<b>0 460 304 140</b>
<b>4</b>	3,6	67	720	06.80-09.86		<b>0 460 304 197</b>
<b>Traffic</b>						
<b>2.1 D</b>	2,1	44	J8S	07.86-10.99	WEG	<b>0 460 494 381</b>
		47	J8S 620	09.94-10.97	WEG	<b>0 460 494 351 0 986 440 149</b>
					WEG	<b>0 460 494 381</b>
			J8S 622	09.94-10.97	WEG	<b>0 460 494 351 0 986 440 149</b>
			J8S 758	09.94-10.97	WEG	<b>0 460 494 351 0 986 440 149</b>
					WEG	<b>0 460 494 381</b>
<b>2.5 D</b>	2,5	52-55	Sofim 8140.61.240 <S8U 722>	01.84-02.89		<b>0 460 494 109</b>
		55	S8U 758 <Sofim8140.67,2550/52>	09.94-10.97	WEG	<b>0 460 404 081</b>
					WEG	<b>0 460 404 087</b>
			8140.67.2500 <S8U 750>	03.89-10.97		<b>0 460 494 340</b>
			8140.67.2580 <S8U 752>	03.89-10.97		<b>0 460 404 066</b>
D, D 4x4	2,5	55	S8U 782	11.97-05.01	BO,WEG	<b>0 460 404 081</b>
					BO,WEG	<b>0 460 404 087</b>
D 4x4	2,5	55	S8U 758	11.97-05.01	WEG	<b>0 460 404 087</b>
<b>Winnebago</b>						
<b>2.1 D</b>	2,1	57	J8S 234	03.84-06.87		<b>0 460 494 157</b>
<b>50</b>						
	4,0	63	Phaser 90	08.87-10.90		<b>0 460 424 036</b>
		82	Phaser 110T <T4.40>	08.87-03.93		<b>0 460 424 052</b>
					CSA	<b>0 460 424 037</b>
<b>75</b>						
<b>.130</b>	5,5	96	797-20	06.80-05.91		<b>0 460 306 139</b>
<b>85</b>						
<b>.150</b>	5,5	113	798-20	09.84-10.91		<b>0 460 316 020</b>
<b>95</b>						
<b>.130</b>	5,5	96	797-20	06.80-05.91		<b>0 460 306 139</b>
<b>110</b>						
<b>.150</b>	5,5	113	798-20	06.80-10.91		<b>0 460 316 020</b>



**STEYR (STEYR-DAIMLER-PUCH AG)**

Pinzgauer						
2.4 D Turbo	2,4	77	NY		10.86-12.96	0 460 406 055
<b>8 S</b>						
14	6,6	100	WD 612.61		05.89→	0 460 426 099
<b>9 S</b>						
14	6,6	100	WD 612.61		06.86→	0 460 426 099
<b>10 S</b>						
14	6,6	100	WD 612.61		06.86→	0 460 426 099
<b>11 S</b>						
14	6,6	100	WD 612.61		07.89→	0 460 426 099
<b>12 S</b>						
14	6,6	100	WD 612.61		06.86→	0 460 426 099
<b>13 S</b>						
14	6,6	100	WD 612.61		09.88→	0 460 426 099
<b>14 S</b>						
14	6,6	100	WD 612.61; WD 612.92		06.86→	0 460 426 099
<b>15 S</b>						
14	6,6	100	WD 612.92		04.86→	0 460 426 099
<b>591</b>						
.136	6,6	100	WD 612.01		02.82-02.86	0 460 416 021
<b>691</b>						
.136	6,6	100	WD 612.01		02.82-02.86	0 460 416 021
<b>791</b>						
.145	6,6	107	WD 612.00; WD 612.20		11.78-02.86	0 460 306 237

**TALBOT**

Express						
1.9 D [J 5]	1,9	51	XUD9A		11.87-04.88 05.88-12.93	0 460 494 222 0 460 494 240

**TATA (TELCO)**

407						
LPT Turbo	3,0	55	497SP TC BS2		02.02→	0 460 424 235
NA City Ride	3,0	43	497SP NA		04.05-04.05 TW 05.05→ TW	0 460 414 227 0 460 414 245
613						
LPT	5,7	96	697 TCIC <Euro 3>		01.08→	0 460 426 990
709						
LPT 3.8 D	3,8	66	497X128 TC BS2		12.01→	0 460 424 232

**TOYOTA**

Dyna						
4.0	4,0	70	364C		11.88-04.99	0 403 444 116

**VAUXHALL**

Euromidi						
2.0 DT	2,0	51	4 FC1T		09.88-08.96 DKF	9 460 610 354
2.2 D	2,2	45	4 FD1		09.88-08.96 DKF	9 460 610 353
2.4 DT	2,4	56	4 FG1T		09.88-08.96 DKF	9 460 610 795



**VOLVO**

<b>F</b>						
406	3,6	80-88	TD 40 A		01.86-02.86	0 460 416 053
407	3,6	80-88	TD 40 A		01.86-02.86	0 460 416 053
408	3,6	80-88	TD 40 A		01.86-02.86	0 460 416 053
409	3,6	88	TD 40 A		01.86-02.86	0 460 416 053
<b>FL</b>						
6	180, 220, 250	5,5	132/162/184	D6B180; D6B220; D6B250	05.00-05.06	0 470 506 017 0 986 444 082
408		3,6	82-91	TD 41 G	02.86-12.95	0 460 416 053
<b>FLC</b>						
		4,0	99	D4A135 <Euro 2>	09.96-09.00	0 460 424 140

**VOLZHANIN**

<b>Serie 32000</b>						
32901	5,7	96		697 TC65 <Euro 3>	01.10→	0 460 426 990

**VW (VOLKSWAGEN)**

<b>Bus</b>						
1.6 D [24, 25]	1,6	37	CS		08.84-07.87	0 460 494 039 0 986 440 113
D Turbo, D Turbo Syncro [24, 25]	1,6	51	JX		08.84-07.92	0 460 494 152 0 986 440 123
1.7 D [24, 25]	1,7	42	KY		10.86-08.87	0 460 494 039 0 986 440 113
					09.87-07.92	0 460 494 164
<b>California T4</b>						
1.9 D [70, 7D]	1,9	45	1X		09.90-04.97	BIO 0 460 484 102 0 986 440 237
						BIO 0 460 484 031 0 986 440 237
D Turbo [70, 7D]	1,9	50	ABL		10.92-06.94	0 460 494 308 0 986 440 248
				Fg.Nr. →70..SH113 565	07.94-04.95	0 460 494 356 0 986 440 255
				Fg.Nr. 70..SH113 566→	05.95-06.03	0 460 494 417 0 986 440 155
2.4 D [70, 7D]	2,4	55	AJA		05.97-06.03	AG 0 460 485 036
						GS, KL 0 460 485 035 0 986 440 244
						GS, KL 0 460 485 037 0 986 440 253
D, D Syncro [70, 7D]	2,4	57	AAB			
				Fg.Nr. →70..P..200 000	09.90-07.93	GS, KL 0 460 485 003 0 986 440 242
				Fg.Nr. →70..R..080 000	09.90-02.94	AG, KL 0 460 485 009
				Fg.Nr. →70..SH113 565	09.90-04.95	KL 0 460 485 021
				Fg.Nr. 70..R..000 001→70..SH113 565	08.93-04.95	GS, KL 0 460 485 017 0 986 440 242
				Fg.Nr. 70..R..080 001→70..T..199 000	09.90-09.98	AG, KL 0 460 485 022
				Fg.Nr. 70..SH113 566→	05.95-09.98	KL 0 460 485 032
				Fg.Nr. 70..SH113 566→70..T..199 000	05.95-12.95	GS, KL 0 460 485 033
2.5 TDI [70, 7D]	2,5	65/75	AJT; AUF		05.98-06.03	0 460 415 983 0 986 440 562
		75	ACV			
				Fg.Nr. →70..W..081 101	01.95-10.97	0 460 415 996 0 986 440 565
				Fg.Nr. 70..W..081 102→	11.97-06.03	0 460 415 983 0 986 440 562
		111	AHY		05.98-09.00	0 460 415 985 0 986 440 571
			AXG		09.00-06.03	0 460 415 985 0 986 440 571
TDI Syncro [70, 7D]	2,5	75	ACV		03.98-06.03	0 460 415 983 0 986 440 562
TDI, TDI Syncro [70, 7D]	2,5	65/75	AXL; AYC; AYY		04.01-06.03	0 460 415 983 0 986 440 562
<b>Caravelle T4</b>						
1.9 D [70, 7D]	1,9	45	1X		10.90-04.97	BIO 0 460 484 102 0 986 440 237
						BIO 0 460 484 031 0 986 440 237
D Turbo [70, 7D]	1,9	50	ABL		10.92-06.94	0 460 494 308 0 986 440 248
				Fg.Nr. →70..SH113 565	07.94-04.95	0 460 494 356 0 986 440 255
				Fg.Nr. 70..SH113 566→	05.95-06.03	0 460 494 417 0 986 440 155
2.4 D [70, 7D]	2,4	55	AJA		05.97-06.03	AG 0 460 485 036
						GS, KL 0 460 485 035 0 986 440 244
						GS, KL 0 460 485 037 0 986 440 253





◀ VW

<b>2.4 D, D Syncro [70, 7D]</b>	2,4	57	AAB	Fg.Nr. →70..P..200 000	09.90-07.93	GS, KL	<b>0 460 485 003</b>	<b>0 986 440 242</b>		
				Fg.Nr. →70..R..080 000	09.90-02.94	AG, KL	<b>0 460 485 009</b>			
				Fg.Nr. →70..SH113 565	09.90-04.95	KL	<b>0 460 485 021</b>			
				Fg.Nr. 70..R..000 001→70..SH113 565	08.93-04.95	GS, KL	<b>0 460 485 017</b>	<b>0 986 440 242</b>		
				Fg.Nr. 70..R..080 001→70..T..199 000	09.90-09.98	AG, KL	<b>0 460 485 022</b>			
				Fg.Nr. 70..SH113 566→	05.95-09.98	KL	<b>0 460 485 032</b>			
				Fg.Nr. 70..SH113 566→70..T..199 000	05.95-12.95	GS, KL	<b>0 460 485 033</b>			
<b>2.5 TDI [70, 7D]</b>	2,5	65/75 75	AJT; AUF ACV		05.98-06.03		<b>0 460 415 983</b>	<b>0 986 440 562</b>		
				Fg.Nr. →70..W..081 101	01.95-10.97		<b>0 460 415 996</b>	<b>0 986 440 565</b>		
				Fg.Nr. 70..W..081 102→	11.97-06.03		<b>0 460 415 983</b>	<b>0 986 440 562</b>		
					05.98-09.00		<b>0 460 415 985</b>	<b>0 986 440 571</b>		
		111	AHY AXG		09.00-06.03		<b>0 460 415 985</b>	<b>0 986 440 571</b>		
TDI Syncro [70, 7D]	2,5	75	ACV		03.98-06.03		<b>0 460 415 983</b>	<b>0 986 440 562</b>		
TDI, TDI Syncro [70, 7D]	2,5	65/75	AXL; AYC; AYY		04.01-06.03		<b>0 460 415 983</b>	<b>0 986 440 562</b>		
<b>Eurovan</b>										
<b>2.4 D [70]</b>	2,4	57	AAB		07.95-04.97		<b>0 460 485 023</b>	<b>0 986 440 256</b>		
				Fg.Nr. →70-R-040 000	10.92-10.93		<b>0 460 485 010</b>			
				Fg.Nr. 70-R-040 001→	10.93-07.95		<b>0 460 485 019</b>	<b>0 986 440 256</b>		
<b>L</b>										
<b>80</b>	4,0	103	4.10 TCA <Euro 2>		08.96-12.96 01.97-10.97		<b>0 460 424 109</b> <b>0 460 424 115</b>			
<b>LT</b>										
<b>28 2.4 D [28, 29, 21]</b>	2,4	51	ACT 1S		08.92-04.96		<b>0 460 406 075</b>	<b>0 986 440 236</b>		
					08.89-07.92		<b>0 460 406 063</b>	<b>0 986 440 017</b>		
				55	DW					
				Fg.Nr. →28 G 011 995	12.82-01.86		<b>0 460 406 013</b>			
			Fg.Nr. 28 G 011 996→	01.86-07.92			<b>0 460 406 039</b>	<b>0 986 440 233</b>		
<b>2.4 D Turbo [28, 29, 21]</b>	2,4	68	1G 70	1G	08.88-08.92		<b>0 460 406 061</b>	<b>0 986 440 016</b>		
				70	09.92-04.96		<b>0 460 406 073</b>	<b>0 986 440 235</b>		
				75	DV	09.83-08.92		<b>0 460 406 040</b>	<b>0 986 440 234</b>	
				A,CH	06.88-08.92	TW	<b>0 460 406 061</b>	<b>0 986 440 016</b>		
<b>2.5 SDI [2D, 2H]</b>	2,5	55	AGX		05.96-02.99		<b>0 460 415 987</b>	<b>0 986 440 569</b>		
			Fg.Nr. →2D..X..027 000	03.99-04.01			<b>0 460 415 983</b>	<b>0 986 440 562</b>		
			Fg.Nr. 2D..X..027 001→	05.99-04.06			<b>0 460 415 983</b>	<b>0 986 440 562</b>		
<b>2.5 TDI [2D, 2H]</b>	2,5	61/66/ 70/80	ANJ; APA; AVR; BBE; BBF		05.99-04.06		<b>0 460 415 983</b>	<b>0 986 440 562</b>		
		75	AHD							
			Fg.Nr. →2D..W..021 000	05.96-12.97			<b>0 460 415 996</b>	<b>0 986 440 565</b>		
			Fg.Nr. 2D..W..021 001→	01.98-05.99			<b>0 460 415 983</b>	<b>0 986 440 562</b>		
<b>2.8 D Turbo [2D, 2H]</b>	2,8	92	AGK ATA		07.97-12.98		<b>0 460 424 138</b>	<b>0 986 440 228</b>		
				96	01.99-01.02	WEG WEG	<b>0 460 424 138</b> <b>0 460 424 222</b>	<b>0 986 440 228</b>		
<b>31 2.4 D [28, 29, 21]</b>	2,4	51	ACT 1S		08.92-04.96		<b>0 460 406 075</b>	<b>0 986 440 236</b>		
					08.89-07.92		<b>0 460 406 063</b>	<b>0 986 440 017</b>		
				55	DW					
				Fg.Nr. →28 G 011 995	12.82-01.86		<b>0 460 406 013</b>			
			Fg.Nr. 28 G 011 996→	01.86-07.92			<b>0 460 406 039</b>	<b>0 986 440 233</b>		
<b>2.4 D Turbo [28, 29, 21]</b>	2,4	68	1G 70	1G	08.88-08.92		<b>0 460 406 061</b>	<b>0 986 440 016</b>		
				70	09.92-04.96		<b>0 460 406 073</b>	<b>0 986 440 235</b>		
				75	DV	09.83-08.92		<b>0 460 406 040</b>	<b>0 986 440 234</b>	
				A,CH	06.88-08.92	TW	<b>0 460 406 061</b>	<b>0 986 440 016</b>		
<b>35 2.4 D [28, 29, 21]</b>	2,4	51	ACT 1S		08.92-04.96		<b>0 460 406 075</b>	<b>0 986 440 236</b>		
					08.89-07.92		<b>0 460 406 063</b>	<b>0 986 440 017</b>		
				55	DW					
				Fg.Nr. →28 G 011 995	12.82-01.86		<b>0 460 406 013</b>			
			Fg.Nr. 28 G 011 996→	01.86-07.92			<b>0 460 406 039</b>	<b>0 986 440 233</b>		
<b>2.4 D Turbo [28, 29, 21]</b>	2,4	68	1G 70	1G	08.88-08.92		<b>0 460 406 061</b>	<b>0 986 440 016</b>		
				70	09.92-04.96		<b>0 460 406 073</b>	<b>0 986 440 235</b>		
				75	DV	09.83-08.92		<b>0 460 406 040</b>	<b>0 986 440 234</b>	
				A,CH	06.88-08.92	TW	<b>0 460 406 061</b>	<b>0 986 440 016</b>		





35	2.5 SDI [2D, 2H]	2,5	55	AGX	Fg.Nr. →2D..X..027 000	05.96-02.99	0 460 415 987	0 986 440 569		
					Fg.Nr. 2D..X..027 001→	03.99-04.01	0 460 415 983	0 986 440 562		
	2.5 TDI [2D, 2H]	2,5	61/66/70/80	ANJ; APA; AVR; BBE; BBF		05.99-04.06	0 460 415 983	0 986 440 562		
			75	AHD	Fg.Nr. →2D..W..021 000	05.96-12.97	0 460 415 996	0 986 440 565		
					Fg.Nr. 2D..W..021 001→	01.98-05.99	0 460 415 983	0 986 440 562		
	2.8 D Turbo [2D, 2H]	2,8	92	AGK		07.97-12.98	0 460 424 138	0 986 440 228		
96			ATA		01.99-01.02	WEG	0 460 424 138	0 986 440 228		
						WEG	0 460 424 222			
40	2.4 D [28, 29, 21]	2,4	51	ACT		08.92-04.96	0 460 406 075	0 986 440 236		
				1S		08.89-07.92	0 460 406 063	0 986 440 017		
			55	DW	Fg.Nr. →28 G 011 995	12.82-01.86	0 460 406 013			
					Fg.Nr. 28 G 011 996→	01.86-07.92	0 460 406 039	0 986 440 233		
	2.4 D Turbo [28, 29, 21]	2,4	68	1G		08.88-08.92	0 460 406 061	0 986 440 016		
			70	ACL		09.92-04.96	0 460 406 073	0 986 440 235		
			75	DV		09.83-08.92	0 460 406 040	0 986 440 234		
					A,CH	06.88-08.92	TW	0 460 406 061	0 986 440 016	
	2.4 D Turbo 4x4 [29, 21]	2,4	75	DV		09.85-08.92	0 460 406 040	0 986 440 234		
					A,CH	06.88-08.92	TW	0 460 406 061	0 986 440 016	
2.4 D 4x4 [29, 21]	2,4	55	DW		09.85-07.92	0 460 406 039	0 986 440 233			
45	2.4 D [28, 29, 21]	2,4	51	ACT		08.92-04.96	0 460 406 075	0 986 440 236		
			55	DW	Fg.Nr. →28 G 011 995	12.82-01.86	0 460 406 013			
					Fg.Nr. 28 G 011 996→	01.86-07.92	0 460 406 039	0 986 440 233		
	2.4 D Turbo [28, 29, 21]	2,4	70	ACL		09.92-04.96	0 460 406 073	0 986 440 235		
			75	DV		09.83-08.92	0 460 406 040	0 986 440 234		
					A,CH	06.88-08.92	TW	0 460 406 061	0 986 440 016	
	2.4 D Turbo 4x4 [29, 21]	2,4	75	DV		09.85-08.92	0 460 406 040	0 986 440 234		
					A,CH	06.88-08.92	TW	0 460 406 061	0 986 440 016	
	2.4 D 4x4 [29, 21]	2,4	55	DW		09.85-07.92	0 460 406 039	0 986 440 233		
	46	2.5 SDI [2D, 2H]	2,5	55	AGX	Fg.Nr. →2D..X..027 000	05.96-02.99	0 460 415 987	0 986 440 569	
						Fg.Nr. 2D..X..027 001→	03.99-04.01	0 460 415 983	0 986 440 562	
2.5 TDI [2D, 2H]		2,5	61/66/70/80	ANJ; APA; AVR; BBE; BBF		05.99-04.06	0 460 415 983	0 986 440 562		
					75	AHD	Fg.Nr. →2D..W..021 000	05.96-12.97	0 460 415 996	0 986 440 565
							Fg.Nr. 2D..W..021 001→	01.98-05.99	0 460 415 983	0 986 440 562
			2.8 D Turbo [2D, 2H]	2,8	92	AGK		07.97-12.98	0 460 424 138	0 986 440 228
96		ATA				01.99-01.02	WEG	0 460 424 138	0 986 440 228	
							WEG	0 460 424 222		
50		2.4 D [28, 29, 21]	2,4	51	ACT		08.92-04.96	0 460 406 075	0 986 440 236	
				55	DW	Fg.Nr. →28 G 011 995	12.82-01.86	0 460 406 013		
					Fg.Nr. 28 G 011 996→	01.86-07.92	0 460 406 039	0 986 440 233		
	2.4 D Turbo [28, 29, 21]	2,4	70	ACL		09.92-04.96	0 460 406 073	0 986 440 235		
			75	DV		09.83-08.92	0 460 406 040	0 986 440 234		
					A,CH	06.88-08.92	TW	0 460 406 061	0 986 440 016	
55	2.4 D [28, 29, 21]	2,4	51	ACT		08.92-04.96	0 460 406 075	0 986 440 236		
			55	DW	Fg.Nr. →28 G 011 995	08.85-01.86	0 460 406 013			
					Fg.Nr. 28 G 011 996→	01.86-07.92	0 460 406 039	0 986 440 233		
	2.4 D Turbo [28, 29, 21]	2,4	70	ACL		09.92-04.96	0 460 406 073	0 986 440 235		
75			DV		08.85-08.92	0 460 406 040	0 986 440 234			
				A,CH	06.88-08.92	TW	0 460 406 061	0 986 440 016		
<b>L80</b>										
	[2V]	4,3	103	AGF		01.97-12.99	0 460 424 115			
<b>Multivan T4</b>										
1.9	D [70, 7D]	1,9	45	1X		09.90-04.97	BIO	0 460 484 102	0 986 440 237	
							BH	0 460 484 031	0 986 440 237	





◀ VW

1.9 D Turbo [70, 7D]	1,9	50	ABL		10.92-06.94		0 460 494 308	0 986 440 248
				Fg.Nr. →70..SH113 565	07.94-04.95		0 460 494 356	0 986 440 255
				Fg.Nr. 70..SH113 566→	05.95-06.03		0 460 494 417	0 986 440 155
2.4 D [70, 7D]	2,4	55	AJA		05.97-06.03	AG	0 460 485 036	
						GS, KL	0 460 485 035	0 986 440 244
D, D Syncro [70, 7D]	2,4	57	AAB					
				Fg.Nr. →70..P..200 000	09.90-07.93	GS, KL	0 460 485 003	0 986 440 242
				Fg.Nr. →70..R..080 000	09.90-02.94	AG, KL	0 460 485 009	
				Fg.Nr. →70..SH113 565	09.90-04.95	KL	0 460 485 021	
				Fg.Nr. 70..R..000 001→70..SH113 565	08.93-04.95	GS, KL	0 460 485 017	0 986 440 242
				Fg.Nr. 70..R..080 001→70..T..199 000	09.90-09.98	AG, KL	0 460 485 022	
				Fg.Nr. 70..SH113 566→	05.95-09.98	KL	0 460 485 032	
				Fg.Nr. 70..SH113 566→70..T..199 000	05.95-12.95	GS, KL	0 460 485 033	
2.5 TDI [70, 7D]	2,5	65/75	AJT; AUF		05.98-06.03		0 460 415 983	0 986 440 562
		75	ACV					
				Fg.Nr. →70..W..081 101	01.95-10.97		0 460 415 996	0 986 440 565
				Fg.Nr. 70..W..081 102→	11.97-06.03		0 460 415 983	0 986 440 562
		111	AHY		05.98-09.00		0 460 415 985	0 986 440 571
			AXG		09.00-06.03		0 460 415 985	0 986 440 571
TDI Syncro [70, 7D]	2,5	75	ACV		03.98-06.03		0 460 415 983	0 986 440 562
TDI, TDI Syncro [70, 7D]	2,5	65/75	AXL; AYC; AYY		04.01-06.03		0 460 415 983	0 986 440 562
<b>Transporter</b>								
1.6 D	1,6	40	BE <222>		10.81-10.89		0 460 494 124	
<b>Transporter T3</b>								
1.6 D [24, 25]	1,6	37	CS		01.81-07.87		0 460 494 039	0 986 440 113
D Turbo, D Turbo Syncro [24, 25]	1,6	51	JX		08.84-07.92		0 460 494 152	0 986 440 123
1.7 D [24, 25]	1,7	42	KY		10.86-08.87		0 460 494 039	0 986 440 113
					09.87-07.92		0 460 494 164	
<b>Transporter T4</b>								
1.9 D [70, 7D]	1,9	45	1X		09.90-04.97	BIO	0 460 484 102	0 986 440 237
						<del>BIO</del>	0 460 484 031	0 986 440 237
D Turbo [70, 7D]	1,9	50	ABL		10.92-06.94		0 460 494 308	0 986 440 248
				Fg.Nr. →70..SH113 565	07.94-04.95		0 460 494 356	0 986 440 255
				Fg.Nr. 70..SH113 566→	05.95-06.03		0 460 494 417	0 986 440 155
2.4 D [70, 7D]	2,4	55	AJA		05.97-06.03	AG	0 460 485 036	
						GS, KL	0 460 485 035	0 986 440 244
D, D Syncro [70, 7D]	2,4	57	AAB					
				Fg.Nr. →70..P..200 000	09.90-07.93	GS, KL	0 460 485 003	0 986 440 242
				Fg.Nr. →70..R..080 000	09.90-02.94	AG, KL	0 460 485 009	
				Fg.Nr. →70..SH113 565	09.90-04.95	KL	0 460 485 021	
				Fg.Nr. 70..R..000 001→70..SH113 565	08.93-04.95	GS, KL	0 460 485 017	0 986 440 242
				Fg.Nr. 70..R..080 001→70..T..199 000	09.90-09.98	AG, KL	0 460 485 022	
				Fg.Nr. 70..SH113 566→	05.95-09.98	KL	0 460 485 032	
				Fg.Nr. 70..SH113 566→70..T..199 000	05.95-12.95	GS, KL	0 460 485 033	
2.5 TDI [70, 7D]	2,5	65/75	AJT; AUF		05.98-06.03		0 460 415 983	0 986 440 562
		75	ACV					
				Fg.Nr. →70..W..081 101	01.95-10.97		0 460 415 996	0 986 440 565
				Fg.Nr. 70..W..081 102→	11.97-06.03		0 460 415 983	0 986 440 562
		111	AHY		05.98-09.00		0 460 415 985	0 986 440 571
			AXG		09.00-06.03		0 460 415 985	0 986 440 571
TDI Syncro [70, 7D]	2,5	75	ACV		03.98-06.03		0 460 415 983	0 986 440 562
TDI, TDI Syncro [70, 7D]	2,5	65/75	AXL; AYC; AYY		04.01-06.03		0 460 415 983	0 986 440 562
<b>6t</b>								
6 .80	3,8	63	4.236		01.83-10.86	DEP	9 407 083 296	
<b>7t</b>								
7 .90 P	3,8	63	4.236		02.87-10.93	DEP	9 407 083 296	
<b>14t</b>								
14 .150	6,5	105	6.10		11.95-02.00		0 460 426 250	
.170 BT	5,8	116	6 BTAA		04.97-02.00		0 460 426 251	







**CASE IH (CASE INTERNATIONAL)**

<b>Serie E</b>						
833 , A	3,9	49	D-239	01.86-05.87	<b>0 460 304 224</b>	
				06.87-12.90	<b>0 460 304 225</b>	
<b>Serie V</b>						
433	2,5	29	D-155	01.86-02.88	<b>0 460 303 149</b>	
				03.88-06.90	<b>0 460 403 010</b>	
533	2,5	33	D-155	01.86-02.88	<b>0 460 303 128</b>	
				03.88-06.90	<b>0 460 403 011</b>	
<b>Serie 300</b>						
321	3,9	55	D-239	01.86-06.86	<b>0 460 304 176</b>	
<b>Serie 400</b>						
431	3,9	55	D-239	01.86-06.86	<b>0 460 304 176</b>	
	5,1	63	D-310	01.86-06.86	<b>0 460 306 177</b>	
433	2,5	26	D-155	01.86-02.88	<b>0 460 303 149</b>	
				03.88-06.90	<b>0 460 403 010</b>	
<b>Serie 500</b>						
531	2,5	33	D-310	01.86-06.86	<b>0 460 306 157</b>	
	5,9	92	D-358	01.86-06.86	<b>0 460 306 166</b>	
533 , A	2,5	33	D-155	01.86-02.88	<b>0 460 303 128</b>	
				03.88-12.90	<b>0 460 403 011</b>	
<b>Serie 600</b>						
633 , A	2,5	38	D-179	02.87-12.90	<b>0 460 403 012</b>	
644 , A	3,4	44	D-206	01.86-06.86	<b>0 460 304 180</b>	
<b>Serie 800</b>						
833 , A	3,9	49	D-239	09.81-05.87	<b>0 460 304 224</b>	
				05.87-12.90	<b>0 460 304 225</b>	
844 , A	4,3	55	D-246	01.86-04.88	<b>0 460 314 025</b>	
S, SA	4,4	59	D-268	01.86-12.86	<b>0 460 314 027</b>	
				01.87-12.90	<b>0 460 414 048</b>	
<b>Serie 900</b>						
956 XLA [C]	5,9	70	D-358	01.86-05.87	<b>0 460 306 262</b>	
				06.87-12.92	<b>0 460 406 056 0 986 440 015</b>	
<b>Serie 1000</b>						
1056 , XLA [C]	5,9	77	D-358	01.86-06.87	<b>0 460 306 264</b>	
				07.87-12.96	<b>0 460 406 056 0 986 440 015</b>	

**FIAT**

<b>50-Serie</b>						
55 .90	2,7	38	8035.06.200	03.84-08.88	<b>0 460 413 002</b>	
<b>60-Serie</b>						
60 .46, .90, DT	2,9	42	8035.05.200; 8035.05.206, 306	03.84-08.88	<b>0 460 413 001 0 986 440 021</b>	
65 .66, .90	3,6	48	8045.06.220, 321; 8045.06.225	06.87-08.88	<b>0 460 414 024</b>	
<b>70-Serie</b>						
70 .90	3,6	51	8045.06.200	03.84-08.88	<b>0 460 414 015</b>	
<b>80-Serie</b>						
80 .90, DT	3,9	59	8045.05.205	03.84-08.88	<b>0 460 414 013 0 986 440 024</b>	
<b>90-Serie</b>						
90 .90	4,9	70	8055.05.200	06.84-08.88	<b>0 460 415 005</b>	
<b>100-Serie</b>						
100 .90	5,4	74	8065.06.200	06.84-08.88	<b>0 460 416 036</b>	
110 .90	5,9	81	8065.05.220	11.86-08.88	<b>0 460 416 036</b>	



**FIAT-ALLIS**

<b>F</b>					
4 M	2,9	42	8035.05.265	04.85-12.92	<b>0 460 413 005</b>
<b>FD</b>					
7	5,9	73	8065.05.295	03.86-10.92	<b>0 460 416 051</b>

**GAZ**

<b>2330</b>					
5.9 TD	5,9	132	B 180-20	05.06→	<b>0 460 426 249</b>

**STEYR (STEYR-DAIMLER-PUCH AG)**

<b>Serie 8000</b>					
8055 , , a	2,6	35	WD 311.44; WD 311.45	02.82-09.86	<b>0 460 303 158</b>
, a	2,6	35	WD 311.46; WD 311.47	D,F 09.86-09.01	<b>0 460 413 006</b>
8060 , , a	2,6	35	WD 311.40; WD 311.41	01.80-02.87	<b>0 460 303 158</b>
8065 , a	2,6	41	WD 311.85	09.86-09.01	<b>0 460 413 007</b>
8070 , a	3,5	47	WD 411.43, 44	D,F 10.84-10.99	<b>0 460 414 014</b>
8075 , a	3,5	47	WD 411.45, 46	D,F 01.84-01.99	<b>0 460 414 014</b>
8080 , a	3,5	53	WD 411.89, 90	D,F 06.84-06.99	<b>0 460 414 011</b>
8130 , a	5,2	81	WD 611.87, 88	10.84-07.99	<b>0 460 416 032</b>
8150 , a	6,6	99	WD 612.87	12.82-12.97	<b>0 460 426 029</b>
8170 , a	6,6	100	WD 612.89	01.88-12.88	<b>0 460 426 109</b>





l/ccm



kW/(PS)



Typ



IVECO

**8100**

<b>8131</b> .61.210 [Sofim]	1,8	38	8131.61.210	01.83-12.89	<b>0 460 403 003</b>	
<b>8140</b> .21.235 [Sofim]	2,4	68	8140.21.235 <8141 S 21>	06.87-12.89	<b>0 460 414 008</b>	<b>0 986 440 023</b>
.21.290 [Sofim]	2,4	68	8140.21.290 <DailyTurbo, 49-10>	06.88-12.00	<b>0 460 414 060</b>	
<b>8141</b> .61.203 [Sofim]	2,4	53	8141.61.203 <8141  000>	10.84-12.89	<b>0 460 494 109</b>	
.67.203 [Sofim]	2,4	55	8141.67.203 <8141  67>	07.87-12.89	<b>0 460 494 189</b>	





**ALFA ROMEO**

<b>Brera</b>						
2.0 JTDM [939]	2,0	125	939B3000 <M120>		05.09→	<b>0 281 002 917</b>
2.4 JTDM 20V [939]	2,4	147	939A3000 <M95>		04.06→	<b>0 281 002 763</b>
		154	939A9000 <M105>		05.07→	<b>0 281 002 764</b>
<b>Giulietta</b>						
1.6 JTDM [191]	1,6	77	940A3000		05.10→	<b>0 281 002 917</b>
2.0 JTDM [191]	2,0	103/125	940A4000; 940A5000		05.10→	<b>0 281 002 917</b>
<b>GT</b>						
1.9 JTD 16V [937]	1,9	103	937A5000 <M15>		10.03→	<b>0 280 218 120</b>
		110	937A5000 <M92>		01.04-06.07	<b>0 281 002 792</b>
					07.07→	<b>0 281 002 980</b>
		125	937A6000 <M94>		10.07→	<b>0 281 002 980</b>
<b>Mito</b>						
1.3 JTD [145]	1,3	66/70	199A3000 <M72>; 199B1000 <M95>		10.08→	<b>0 281 002 980</b>
1.6 JTD [145]	1,6	84/88	955A3000 <M88>; 955A4000 <M87>		08.08→	<b>0 281 002 917</b>
<b>Spider</b>						
2.0 JTDM [939]	2,0	125	939B3000 <M120>		05.09-12.10	<b>0 281 002 917</b>
2.4 JTDM 20V [939]	2,4	147	939A3000 <M95>		03.07-12.10	<b>0 281 002 763</b>
		154	939A3000 <M105>		03.08-12.10	<b>0 281 002 764</b>
<b>145</b>						
1.9 JTD [930 MY97]	1,9	76	AR 32302 <M20>		05.98-02.99	<b>0 280 218 019</b>
JTD [930 MY99]	1,9	76	AR 32302 <M20>		02.99-12.00	<b>0 280 218 019</b>
<b>146</b>						
1.9 JTD [930 MY97]	1,9	76	AR 32302 <M13>		05.98-02.99	<b>0 280 218 019</b>
JTD [930 MY99]	1,9	76	AR 32302 <W4 M20>		02.99-12.00	<b>0 280 218 019</b>
<b>147</b>						
1.9 JTD [937]	1,9	81-85	937A2000 <M15>		11.00-03.05	<b>0 280 218 120</b>
JTD, JTDM 16V [937]	1,9	74/100/	182B9000 <M14>; 192A5000 <M17>;		10.02-10.06	<b>0 280 218 120</b>
		103	192B1000 <M18>			
JTDM [937]	1,9	85	939A7000 <M87>		01.06-06.07	<b>0 281 002 792</b>
					07.07-12.10	<b>0 281 002 980</b>
		88	937A3000 <M88>		04.05-06.07	<b>0 281 002 792</b>
					07.07-12.10	<b>0 281 002 980</b>
JTDM 16V [937]	1,9	93/110	937A4000 <M16>; 937A5000 <M19>		06.03-09.06	<b>0 280 218 120</b>
		100	192B1000 <M91>		01.06-06.07	<b>0 281 002 792</b>
					07.07-12.10	<b>0 281 002 980</b>
		110	937A5000 <M92>		06.05-06.07	<b>0 281 002 792</b>
					07.07-12.10	<b>0 281 002 980</b>
		125	937A6000 <M94>		10.07-12.10	<b>0 281 002 980</b>
<b>155</b>						
2.5 TD [167 MY92]	2,5	92	VM07B / VM31B <M2/M3>		04.93-04.96	<b>0 280 202 205</b>
TD [167 MY96]	2,5	92	VM31B <M2>		05.96-10.97	<b>0 280 202 205</b>
<b>156 Berlina</b>						
1.9 JTD [932]	1,9	74	182B9.000 <M24>		06.03-12.04	<b>0 281 002 309</b>
		76	AR32302 <M1>		10.97-04.98	<b>0 281 002 199</b>
					05.98-09.00	<b>0 280 218 019</b>
		81-85	AR37101 / 937A2.000 <M3/M5>		09.00-12.01	<b>0 281 002 309</b>
JTD 16V [932]	1,9	85	937A2.000 <M25>		01.02-10.05	<b>0 281 002 309</b>
		93	937A4.000 <M26>		06.03-10.05	<b>0 280 218 113</b>
		100/103	192A5.000 <M27>; 192B1000 <M29>		10.02-10.05	<b>0 280 218 113</b>
2.4 JTD [932]	2,4	100	AR32501 <M2>		10.97-04.98	<b>0 281 002 199</b>
					05.98-09.00	<b>0 280 218 019</b>
		100/110	839A6.000 <M4>; 841C000 <M30>		09.00-10.05	<b>0 281 002 309</b>
JTD, JTD 20V [932]	2,4	120/129	841G.000 <M31>; 841M000 <M33>		06.03-10.05	<b>0 281 002 598</b>
<b>156 Cross Wagon Q4</b>						
1.9 JTD 4x4 [932]	1,9	110	937A5000 <M28 / M92>		10.04-05.05 EU3	<b>0 280 218 113</b>
					10.04-12.05 EU4	<b>0 281 002 683</b>
<b>156 Sport Wagon</b>						
1.9 JTD [932]	1,9	74	182B9.000 <M24>		06.03-12.04	<b>0 281 002 309</b>
		76	AR32302 CF2 <M1>		06.00-09.00	<b>0 280 218 019</b>





<b>1.9</b> JTD [932]	1,9	80-85	AR37101 / 937A2.000 <M3/M5 CF3>	09.00-12.01	<b>0 281 002 309</b>
		85	937A2.000 <M25>	01.02-12.05	<b>0 281 002 309</b>
JTD 16V [932]	1,9	93	937A4.000 <M26/M90>	06.03-10.05	<b>0 280 218 113</b>
		93/110	937A4000 <M90>; 937A5000 <M82 E4>	10.03-12.05	<b>0 281 002 683</b>
		100/103	192A5.000 <M27>; 192B1000 <M29>	10.02-12.05	<b>0 280 218 113</b>
<b>2.4</b> JTD [932]	2,4	100	AR32501 CF2 <M2>	06.00-09.00	<b>0 280 218 019</b>
		100/110	839A6.000 CF3 <M4>; 841C000 <M30>	09.00-10.05	<b>0 281 002 309</b>
JTD, JTD 20V [932]	2,4	120/129	841G000 <M31>; 841M000 <M33>	06.03-12.05	<b>0 281 002 598</b>
<b>156 Sport Wagon Q4</b>					
<b>1.9</b> JTD 16V 4x4 [932]	1,9	110	937A5000 <M28 / M92>	10.04-05.05 EU3	<b>0 280 218 113</b>
				10.04-12.05 EU4	<b>0 281 002 683</b>
<b>159</b>					
<b>2.0</b> JTDM 16V [939..]	2,0	100		06.10→	<b>0 281 002 917</b>
<b>159 Berlina</b>					
<b>1.9</b> JTDM 8V, JTDM 16V [939]	1,9	85/88/ 100/110	937A7000 <M87 E4>; 937A8000 <M91>; 939A1000 <M88 E4>; 939A2000 <M92 E4>	06.05-12.08	<b>0 281 002 861</b>
<b>2.0</b> JTDM 16V [939]	2,0	125	939B3000 <M120>	05.09-12.10	<b>0 281 002 917</b>
<b>2.4</b> JTD 20V, JTDM 20V [939]	2,4	147/154	939A3000 <M95 E4>; 939A9000 <M105>	06.05-12.08	<b>0 281 006 048</b>
<b>159 Berlina Q4</b>					
<b>2.4</b> JTD 20V [939]	2,4	154	939A9000 <M110>	09.06-12.08	<b>0 281 006 048</b>
<b>159 Sport Wagon</b>					
<b>1.9</b> JTDM 8V, JTDM 16V [939]	1,9	85/88/ 100/110	937A7000 <M87 E4>; 937A8000 <M91>; 939A1000 <M88 E4>; 939A2000 <M92 E4>	03.06-12.08	<b>0 281 002 861</b>
<b>2.0</b> JTDM 16V [939..]	2,0	100		06.10→	<b>0 281 002 917</b>
JTDM 16V [939]	2,0	125	939B3000 <M120>	05.09-12.10	<b>0 281 002 917</b>
<b>2.4</b> JTD 20V, JTDM 20V [939]	2,4	147/154	939A3000 <M95 E4>; 939A9000 <M105>	03.06-12.08	<b>0 281 006 048</b>
<b>159 Sport Wagon Q4</b>					
<b>2.4</b> JTD 20V [939]	2,4	154	939A9000 <M110>	09.06-12.08	<b>0 281 006 048</b>
<b>164</b>					
<b>2.5</b> D Turbo [164]	2,5	92	VM08B / VM32B <M8/M9>	09.92-10.98	<b>0 281 002 085</b>
<b>166</b>					
<b>2.4</b> JTD [936]	2,4	100	AR 34202 <M20>	10.98-09.00	<b>0 280 218 019</b>
		100-110	839A6000 / 841C000 <M21/M22>	09.00-10.07	<b>0 281 002 309</b>
JTD 20V [936]	2,4	120/128/ 129	841G000 / 841H000 <M25/M26>; 841M000 <M27>; 841N000 <M28>	06.03-10.07	<b>0 281 002 598</b>
JTDM 20V [936]	2,4	132-136	936B000 <M99>	10.05-10.07	<b>0 281 002 763</b>

**AUDI**

<b>A1</b>					
<b>2.0</b> TDI [8X1]	2,0	100/105	CFHB <D92>; CFHD <D92>	09.11→	<b>0 281 002 956</b>
<b>A1 Sportback</b>					
<b>2.0</b> TDI [8XA]	2,0	100/105	CFHB <D92>; CFHD <D92>	09.11→	<b>0 281 002 956</b>
<b>A2</b>					
<b>1.4</b> TDI [8Z0]	1,4	55/66	ATL; BHC	05.03-08.05	<b>0 281 002 610</b>
<b>A3</b>					
<b>1.9</b> TDI [8L1]	1,9	66/81	AGR; AHF		
			Fg.Nr. 8L..X..000 001→	08.98-08.00	<b>0 281 002 757</b>
				WW	<b>0 280 217 121 0 986 280 202</b>
			ALH; ASV	08.97-06.01	<b>0 281 002 757</b>
				WW	<b>0 280 217 121 0 986 280 202</b>
		74	ATD		
			Fg.Nr. →8L..2..040 000	09.00-10.01	<b>0 281 002 757</b>
				WW	<b>0 280 217 121 0 986 280 202</b>
			Fg.Nr. 8L..2..040 001→	10.01-06.03	<b>0 281 002 531 0 986 284 009</b>
			AXR	11.01-06.03	<b>0 281 002 531 0 986 284 009</b>
TDI [8P1]	1,9	77	BKC; BLS; BXE	06.03-05.10	<b>0 281 002 531 0 986 284 009</b>
TDI, TDI quattro [8L1]	1,9	96	ASZ		
			Fg.Nr. →8L..2..105 000	05.00-04.02	<b>0 280 217 529 0 986 280 204</b>
			Fg.Nr. 8L..2..105 001→	04.02-06.03	<b>0 281 002 461 0 986 284 007</b>





◀ AUDI

2.0 TDI, TDI quattro [8P1]	2,0	100/103/120/125	AZV; BKD; BMM; BMN; BUY	05.03-06.08	0 281 002 461	0 986 284 007
		100/103/125	CBAA; CBAB; CBAB <D91>; CBBB <D93>	07.08-05.10	0 281 002 735	
			CFFA <D94>; CFFB <D91>; CFGB <D93>; CLJA <D91>	11.09→	0 281 002 956	

**A3 Cabriolet**

1.9 TDI [8P7]	1,9	77	BLS <D3W>	04.08-05.09	0 281 002 531	0 986 284 009
2.0 TDI [8P7]	2,0	100/103	CBAA <D94>; CBAB <D91>	04.08-05.10	0 281 002 735	

**A3 Sportback**

1.9 TDI [8PA]	1,9	77	BKC; BLS <D3W>; BXE <D3W>	09.04-05.10	0 281 002 531	0 986 284 009
2.0 TDI, TDI quattro [8PA]	2,0	100/103/120/125	AZV; BKD; BMM; BMN; BUY	09.04-06.08	0 281 002 461	0 986 284 007
		100/103/125	CBAA <D94>; CBAB <D91>; CBBB <D93>	07.08-05.10	0 281 002 735	
			CFFA <D94>; CFFB <D91>; CFGB <D93>; CLJA <D91>	11.09→	0 281 002 956	

**A4**

1.9 TDI [8EC; B7]	1,9	85	BKE	11.04-11.05	0 281 002 461	0 986 284 007
			BRB	01.06-06.08	0 281 002 461	0 986 284 007
TDI [8E2; B6]	1,9	74	AVB			
			Fg.Nr. →8E..2..120 000	04.01-09.01	0 281 002 757	
				WW	0 280 217 121	0 986 280 202
			Fg.Nr. 8E..2..120 001→	09.01-05.04	0 281 002 531	0 986 284 009
		85	BKE	06.04-12.04	0 281 002 461	0 986 284 007
		96	AWX			
			Fg.Nr. →8E..1..080 000	12.00-04.01	0 280 217 529	0 986 280 204
			Fg.Nr. 8E..2..000 001→	04.01-06.03	0 281 002 461	0 986 284 007
TDI, TDI quattro [8D2; B5]	1,9	55/66/81/85	AFF; AFN; AHU; AJM; ATJ; AVG	08.97-11.00	0 281 002 216	0 986 284 001
TDI, TDI quattro [8E2; B6]	1,9	96	AVF	04.01-12.04	0 281 002 461	0 986 284 007
2.0 TDI [8K2; B8]	2,0	100	CJCB <D94>	11.10→	0 281 002 956	
		105	CMEA <D92>	05.10→	0 281 002 735	
TDI, TDI quattro [8EC; B7]	2,0	89/93/100/103/120/125	BLB; BNA; BPW; BRD; BRE; BRF; BVA; BVF; BVG	11.04-06.08	0 281 002 461	0 986 284 007
TDI, TDI quattro [8K2; B8]	2,0	88/100/105/120/125	CAGA <D92>; CAGB <D94>; CAGC <D90>; CAHA <D93>; CAHB <D95>	11.07→	0 281 002 735	
2.5 TDI, TDI quattro [8D2; B5]	2,5	110	AFB	08.97-06.00	0 281 002 429	0 986 284 005
			AKN			
			Fg.Nr. →8D..X..400 000	07.98-06.99	0 281 002 429	0 986 284 005
			Fg.Nr. 8D..Y..000 001→	07.99-10.00	0 281 002 403	0 986 284 004

**A4 Avant**

1.9 TDI [8D5; B5]	1,9	66	AHH	04.97-09.01	0 281 002 216	0 986 284 001
TDI [8ED; B7]	1,9	85	BKE; BRB	11.04-06.08	0 281 002 461	0 986 284 007
TDI [8E5; B6]	1,9	74	AVB	09.01-05.04	0 281 002 531	0 986 284 009
TDI, TDI quattro [8D5; B5]	1,9	66/81/85	AHU; AJM; ATJ; AVG	08.97-09.01	0 281 002 216	0 986 284 001
		81	AFN	08.97-07.99	0 281 002 216	0 986 284 001
TDI, TDI quattro [8E5; B6]	1,9	85/96	AVF; AWX; BKE	09.01-12.04	0 281 002 461	0 986 284 007
2.0 TDI [8K5; B8]	2,0	100	CJCB <D94>	11.10→	0 281 002 956	
		105	CMEA <D92>	05.10→	0 281 002 735	
TDI, TDI quattro [8ED; B7]	2,0	89/93/100/103/120/125	BLB; BNA; BPW; BRD; BRE; BRF; BVA; BVF; BVG	11.04-06.08	0 281 002 461	0 986 284 007
TDI, TDI quattro [8K5; B8]	2,0	88/100/105/120/125	CAGA <D92>; CAGB <D94>; CAGC <D90>; CAHA <D93>; CAHB <D95>	04.08→	0 281 002 735	
2.5 TDI, TDI quattro [8D5; B5]	2,5	110	AFB	11.97-06.00	0 281 002 429	0 986 284 005
			AKN			
			Fg.Nr. →8D..X..400 000	07.98-06.99	0 281 002 429	0 986 284 005
			Fg.Nr. 8D..Y..000 001→	07.99-09.01	0 281 002 403	0 986 284 004

**A4 Avant Allroad**

2.0 TDI [8KH]	2,0	100/105/120/125	CAGA <D92>; CAGB <D94>; CAHA <D93>; CAHB <D95>	04.09→	0 281 002 735	
---------------	-----	-----------------	--	--------	---------------	--





<b>A4 Cabriolet</b>							
2.0 TDI [8HE; B7]	2,0	100/103	BPW; BRC		01.06-03.09	0 281 002 461	0 986 284 007
<b>A5 Cabriolet</b>							
2.0 TDI [8F7]	2,0	120/125	CAHA <D93>; CAHB <D95>		05.09→	0 281 002 735	
TDI, TDI quattro [8F7]	2,0	105/120/ 130	CGLC <DE2>; CGLD <D95>; CJCA <D92>		10.11→	0 281 002 956	
<b>A5 Coupé</b>							
2.0 TDI, TDI quattro [8T3]	2,0	120/125	CAHA <D93>; CAHB <D95>		01.08→	0 281 002 735	
		120/130	CGLC <DE2>; CGLD <D95>		08.11→	0 281 002 956	
<b>A5 Sportback</b>							
2.0 TDI [8TA]	2,0	100/105/ 120/130	CGLC <DE2>; CGLD <D95>; CJCA <D92>; CJCB <D94>		08.11→	0 281 002 956	
		105	CMEA <D92>		05.10→	0 281 002 735	
			CMFA <D92>		11.11→	0 281 002 956	
TDI, TDI quattro [8TA]	2,0	100/120/ 125	CAGB <D94>; CAHA <D93>; CAHB <D95>		09.09→	0 281 002 735	
<b>A6</b>							
1.9 TDI [4B2; C5]	1,9	81	AVG		08.99-10.00	0 281 002 216	0 986 284 001
		81/85	AFN; AJM		04.97-04.01	0 281 002 216	0 986 284 001
		96	AVF		06.01-05.04	0 281 002 461	0 986 284 007
			AWX		06.01-05.04	0 281 002 461	0 986 284 007
2.0 TDI [4F2; C6]	2,0	89/100/ 103	BLB; BNA; BRE; BRF; BVG		07.04-06.08	0 281 002 461	0 986 284 007
TDI [4G2; C7]	2,0	100/120/ 130	CGLC <DE2>; CGLD <D95>; CGLE <D94>; CMGB <DE2>		02.11→	0 281 002 956	
TDI, TDI e [4F2; C6]	2,0	100/120/ 125	CAGB <D94>; CAHA <D93>; CAHB <D95>		10.08→	0 281 002 735	
2.5 TDI, TDI quattro [4A2; C4]	2,5	85/103	AAT; AEL		06.94-10.97	0 281 002 074	
TDI, TDI quattro [4B2; C5]	2,5	110	AFB; AKN		04.97-04.01	0 281 002 429	0 986 284 005
<b>A6 Avant</b>							
1.9 TDI [4B5; C5]	1,9	81/85	AFN; AJM		02.98-04.01	0 281 002 216	0 986 284 001
		96	AVF; AWX		06.01-01.05	0 281 002 461	0 986 284 007
2.0 TDI [4F5; C6]	2,0	89/100/ 103	BLB; BNA; BRE; BRF; BVG		06.05-10.08	0 281 002 461	0 986 284 007
TDI [4G5; C7]	2,0	100/120/ 130	CGLC <DE2>; CGLD <D95>; CGLE <D94>; CMGB <DE2>		05.11→	0 281 002 956	
TDI, TDI e [4F5; C6]	2,0	100/120/ 125	CAGB <D94>; CAHA <D93>; CAHB <D95>		10.08→	0 281 002 735	
2.5 TDI [4B5; C5]	2,5	110	AKN				
			Fg.Nr. →8D..X..400 000		11.98-06.99	0 281 002 429	0 986 284 005
			Fg.Nr. 8D..Y..000 001→		07.99-04.01	0 281 002 403	0 986 284 004
TDI quattro [4B5; C5]	2,5	110	AKN		11.98-04.01	0 281 002 429	0 986 284 005
TDI, TDI quattro [4A5; C4]	2,5	85/103	AAT; AEL		06.94-10.97	0 281 002 074	
TDI, TDI quattro [4B5; C5]	2,5	110	AFB		02.98-05.00	0 281 002 429	0 986 284 005
<b>A8</b>							
2.5 TDI, TDI quattro [4D2; D2]	2,5	110	AFB; AKN		06.97-09.02	0 281 002 429	0 986 284 005
3.3 TDI quattro [4D2; D2]	3,3	165	AKF		12.99-08.02	0 281 002 435	0 986 284 006
4.2 TDI quattro [4H; D4]	4,2	258	CDSB		11.09→	SFU	0 281 006 069
<b>Q3</b>							
2.0 TDI, TDI quattro [8UB]	2,0	100/103/ 120/130	CFFA <D94>; CFFB <D91>; CFGC <DE2>; CFGD <D95>; CLLB <DE2>		06.11→	0 281 002 956	
<b>Q5</b>							
2.0 TDI quattro [8RB]	2,0	100/105/ 120/125	CAGA <D92>; CAGB <D94>; CAHA <D93>; CAHB <D95>		11.08-09.10	0 281 002 735	
TDI, TDI quattro [8RB]	2,0	100/105/ 120/125	CGLA <D95>; CGLB <D93>; CJCA <D92>; CJCB <D94>		05.10→	0 281 002 956	
<b>TT Coupé</b>							
2.0 TDI quattro [8J3]	2,0	125	CBBB		06.08-06.10	0 281 002 735	
			CFGB		05.10→	0 281 002 956	
<b>TT Roadster</b>							
2.0 TDI quattro [8J9]	2,0	125	CBBB		06.08-06.10	0 281 002 735	
			CFGB		05.10→	0 281 002 956	





◀ AUDI

<b>80</b>						
1.9 TDI [8C2; B4]	1,9	66	1Z			
				Fg.Nr. →8C..R..128 401	09.91-01.94 GS	<b>0 281 002 072</b>
<b>80 Avant</b>						
1.9 TDI [8C5; B4]	1,9	66	1Z			
				Fg.Nr. →8C..R..128 401	08.92-01.94 GS	<b>0 281 002 072</b>
<b>100</b>						
2.5 TDI [4A2; C4]	2,5	85	AAT		08.91-07.94	<b>0 281 002 074</b>
<b>100 Avant</b>						
2.5 TDI [4A5; C4]	2,5	85	AAT		08.91-07.94	<b>0 281 002 074</b>

**BMW**

<b>Serie X</b>						
<b>X1</b> 18 d sDrive, 18 d xDrive [E 84]	2,0	100-105	N47 D20C		11.09→	<b>0 281 006 146</b>
20 d ed sDrive [E 84]	2,0	120	N47 D20C		09.11→	<b>0 281 006 093</b>
20 d sDrive, 20 d xDrive [E 84]	2,0	120-130	N47 D20C		10.09→	<b>0 281 006 146</b>
23 d xDrive [E 84]	2,0	150	N47 D20D		10.09→	<b>0 281 006 146</b>
<b>X3</b> 2.0 d [E 83]	2,0	110	20 4D 4 <M 47N>		10.04-09.07	<b>0 928 400 529</b>
		130	N47 D20A		09.07-08.08	<b>0 281 002 936</b>
3.0 d [E 83]	3,0	150	30 6D 2 <M 57N>		01.04-09.05	<b>0 928 400 529</b>
		160	30 6D 3 <M 57N2>		09.05-08.06	<b>0 928 400 529</b>
					09.06-02.07	<b>0 281 002 849</b>
					03.07-02.10	<b>0 281 002 936</b>
3.0 sd [E 83]	3,0	210	30 6D 5		09.06-02.07	<b>0 281 002 849</b>
					03.07-02.10	<b>0 281 002 936</b>
18 d xDrive [E 83]	2,0	105	N47 D20C		05.09-02.10	<b>0 281 002 936</b>
					03.10-08.10	<b>0 281 006 147</b>
20 d xDrive [E 83]	2,0	120-130	N47 D20...		09.08-02.10	<b>0 281 002 936</b>
					03.10-08.10	<b>0 281 006 147</b>
20 d xDrive [F 25]	2,0	135	N47 D20C		10.10→	<b>0 281 006 092</b>
30 d xDrive [E 83]	3,0	155-160	30 6D 3 <M 57N2>		09.08-02.10	<b>0 281 002 936</b>
					03.10-08.10	<b>0 281 006 147</b>
35 d xDrive [E 83]	3,0	210	30 6D 5		09.08-02.10	<b>0 281 002 936</b>
					03.10-08.10	<b>0 281 006 147</b>
<b>X5</b> 3.0 d [E 53]	3,0	135	30 6D 1 <M 57 D 30>		03.01-09.03 UPE	<b>0 928 400 527</b>
		155-160	30 6D 2 <M 57N>		10.03-10.06	<b>0 928 400 529</b>
3.0 d, 30 d xDrive [E 70]	3,0	155-173	30 6D 3 <M 57N2>		03.07-03.10	<b>0 928 400 529</b>
3.0 sd [E 70]	3,0	210	30 6D 5		10.07-02.10	<b>0 281 002 936</b>
35 d xDrive [E 70]	3,0	210	30 6D 5		10.08-02.10	<b>0 281 002 936</b>
					03.10-03.10	<b>0 281 006 147</b>
<b>X6</b> 30 d xDrive [E 71]	3,0	173	30 6D 3 <M 57N2>		05.08-03.10	<b>0 928 400 529</b>
35 d xDrive [E 71]	3,0	210	30 6D 5		05.08-02.10	<b>0 281 002 936</b>
					03.10-03.10	<b>0 281 006 147</b>
<b>Serie 1</b>						
<b>116 d</b> [E 81]	2,0	85	N47 D20...		03.09→	<b>0 281 006 146</b>
d [E 87]	2,0	85	N47 D20...		03.09-06.11	<b>0 281 006 146</b>
d [F 20]	2,0	85	N47 D20C		09.11→	<b>0 281 006 092</b>
<b>118 d</b> [E 81]	2,0	100-105	N47 D20...		05.07→	<b>0 281 006 146</b>
d [E 87]	2,0	90	20 4D 4 <M 47N>		09.04-03.07	<b>0 928 400 529</b>
		100-105	N47 D20...		03.07-06.11	<b>0 281 006 146</b>
d [F 20]	2,0	105	N47 D20C		09.11→	<b>0 281 006 092</b>
<b>120 d</b> [E 81]	2,0	120-130	N47 D20...		05.07→	<b>0 281 006 146</b>
d [E 87]	2,0	120	20 4D 4 <M 47N>		09.04-03.07	<b>0 928 400 529</b>
		120-130	N47 D20...		03.07-06.11	<b>0 281 006 146</b>
d [F 20]	2,0	135	N47 D20C		09.11→	<b>0 281 006 092</b>
<b>123 d</b> [E 81]	2,0	150	N47 D20B		09.07→	<b>0 281 006 146</b>
d [E 87]	2,0	150	N47 D20...		09.07-06.11	<b>0 281 006 146</b>
<b>Serie 1 Cabrio</b>						
<b>118 d</b> [E 88]	2,0	100-105	N47 D20...		09.08→	<b>0 281 006 146</b>
<b>120 d</b> [E 88]	2,0	120-130	N47 D20...		03.08→	<b>0 281 006 146</b>
<b>123 d</b> [E 88]	2,0	150	N47 D20B		09.08→	<b>0 281 006 146</b>







Serie 1 Coupé						
118 d [E 82]	2,0	100-105	N47 D20C		09.09→	0 281 006 146
120 d [E 82]	2,0	120-130	N47 D20...		10.07→	0 281 006 146
123 d [E 82]	2,0	150	N47 D20B		10.07→	0 281 006 146
Serie 3						
316 d [E 90]	2,0	85	N47 D20C		09.09-02.10 03.10→	0 281 006 146 0 281 006 093
d [F 30]	2,0	85	N47 D20C		03.12→	0 281 006 092
318 d [E 46]	2,0	85	20 4D 1 <M 47 D 20> 20 4D 4 <M 47N>		09.01-03.03 UPE 03.03-03.05 EU3,UPE EU4	0 928 400 527 0 928 400 527 0 928 400 529
d [E 90]	2,0	90	20 4D 4 <M 47N>		09.05-09.07	0 928 400 529
		100-105	N47 D20...		09.07-02.10 03.10→	0 281 006 146 0 281 006 093
d [F 30]	2,0	105	N47 D20C		03.12→	0 281 006 092
320 d [E 46]	2,0	100	20 4D 1 <M 47 D 20>		04.98-09.01 UPE	0 928 400 527
		110	20 4D 4 <M 47N>		09.01-03.05 EU3,UPE EU4	0 928 400 527 0 928 400 529
d [E 90]	2,0	110/120	20 4D 4 <M 47N>		03.05-09.07	0 928 400 529
d, d ed [F 30]	2,0	120/135	N47 D20C		02.12→	0 281 006 092
d, d ed, d xDrive [E 90]	2,0	120-135	N47 D20C <N47N>		03.10→	0 281 006 093
d, d xDrive [E 90]	2,0	130	N47 D20...; N47 D20C		09.07-03.10	0 281 006 146
325 d [E 90]	3,0	145	30 6D 3 <M 57N2>		09.06-02.10	0 928 400 529
330 d, xd [E 46]	3,0	135	30 6D 1 <M 57 D 30>		10.99-04.03 UPE	0 928 400 527
		150	30 6D 2 <M 57N>		03.03-03.05	0 928 400 529
d, xd [E 90]	3,0	170	30 6D 3 <M 57N2>		09.05-08.08	0 928 400 529
335 d [E 90]	3,0	210	30 6D 5 <M 57...>		09.06-02.07 03.07-02.10 03.10→	0 281 002 849 0 281 002 936 0 281 006 147
Serie 3 Cabrio						
320 d [E 46]	2,0	110	20 4D 4 <M 47N>		01.05-08.06 EU3,UPE EU4	0 928 400 527 0 928 400 529
d [E 93]	2,0	120-135	N47 D20C <N47N>		03.10→	0 281 006 093
		130	N47 D20...		03.08-02.10	0 281 006 146
325 d [E 93]	3,0	145	30 6D 3 <M 57N2>		09.07-02.10	0 928 400 529
330 d [E 46]	3,0	150	30 6D 2 <M 57N>		04.05-08.06	0 928 400 529
d [E 93]	3,0	170	30 6D 3 <M 57N2>		03.07-02.09	0 928 400 529
Serie 3 Compact						
318 td [E 46]	2,0	85	20 4D 4 <M 47N>		03.03-12.04 EU3,UPE EU4	0 928 400 527 0 928 400 529
320 td [E 46]	2,0	110	20 4D 4 <M 47N>		09.01-12.04 EU3,UPE EU4	0 928 400 527 0 928 400 529
Serie 3 Coupé						
320 d [E 46]	2,0	110	20 4D 4 <M 47N>		09.03-05.06 EU3,UPE EU4	0 928 400 527 0 928 400 529
d, d xDrive [E 92]	2,0	120-135	N47 D20C <N47N>		03.10→	0 281 006 093
		130	N47 D20...; N47 D20C		03.07-02.10	0 281 006 146
325 d [E 92]	3,0	145	30 6D 3 <M 57N2>		03.07-02.10	0 928 400 529
330 d [E 46]	3,0	150	30 6D 2 <M 57N>		03.03-05.06	0 928 400 529
d, xd [E 92]	3,0	170	30 6D 3 <M 57N2>		09.06-08.08	0 928 400 529
335 d [E 92]	3,0	210	30 6D 5		09.06-02.07 03.07-02.10 03.10→	0 281 002 849 0 281 002 936 0 281 006 147
Serie 3 Touring						
316 d [E 91]	2,0	85	N47 D20C <N47N>		03.10→	0 281 006 093
318 d [E 46]	2,0	85	20 4D 1 <M 47 D 20> 20 4D 4 <M 47N>		03.02-03.03 UPE 03.03-09.05 EU3,UPE EU4	0 928 400 527 0 928 400 527 0 928 400 529
d [E 91]	2,0	90	20 4D 4 <M 47N>		03.06-09.07	0 928 400 529
		100-105	N47 D20...		09.07-02.10 03.10→	0 281 006 146 0 281 006 093





◀ BMW

<b>320 d</b> [E 46]	2,0	100	20 4D 1 <M 47 D 20>	10.99-09.01	UPE	<b>0 928 400 527</b>
		110	20 4D 4 <M 47N>	09.01-09.05	EU3,UPE	<b>0 928 400 527</b>
d [E 91]	2,0	110/120	20 4D 4 <M 47N>	09.05-09.07	EU4	<b>0 928 400 529</b>
d, d ed, d xDrive [E 91]	2,0	120-135	N47 D20C <N47N>	03.10→		<b>0 281 006 093</b>
d, d xDrive [E 91]	2,0	130	N47 D20...; N47 D20C	09.07-02.10		<b>0 281 006 146</b>
<b>325 d</b> [E 91]	3,0	145	30 6D 3 <M 57N2>	09.06-02.10		<b>0 928 400 529</b>
<b>330 d, xd</b> [E 46]	3,0	135	30 6D 1 <M 57 D 30>	10.99-03.03	UPE	<b>0 928 400 527</b>
		150	30 6D 2 <M 57N>	03.03-09.05		<b>0 928 400 529</b>
d, xd [E 91]	3,0	170	30 6D 3 <M 57N2>	09.05-08.08		<b>0 928 400 529</b>
<b>335 d</b> [E 91]	3,0	210	30 6D 5	09.06-02.07		<b>0 281 002 849</b>
				03.07-02.10		<b>0 281 002 936</b>
				03.10→		<b>0 281 006 147</b>
<b>Serie 5</b>						
<b>520 d</b> [E 39]	2,0	100	20 4D 1 <M 47 D 20>	04.00-07.03	UPE	<b>0 928 400 527</b>
d [E 60]	2,0	110/120	20 4D 4 <M 47N>	09.05-02.08		<b>0 928 400 529</b>
		130	N47 D20...	09.07-02.10		<b>0 281 002 936</b>
d [F 10]	2,0	135	N47 D20C <N47N>	05.10→		<b>0 281 006 092</b>
<b>525 d</b> [E 39]	2,5	120	25 6D 1	04.00-07.03	UPE	<b>0 928 400 527</b>
d [E 60]	2,5	120/130	25 6D 2	05.04-03.07		<b>0 928 400 529</b>
d, d xDrive, xd [E 60]	3,0	145	30 6D 3 <M 57N2>	03.07-02.10		<b>0 928 400 529</b>
<b>530 d</b> [E 39]	3,0	135-142	30 6D 1 <M 57 D 30>	08.98-07.03	UPE	<b>0 928 400 527</b>
d, d xDrive, xd [E 60]	3,0	160/170/173	30 6D 2 <M 57N>; 30 6D 3 <M 57N2>	07.03-02.10		<b>0 928 400 529</b>
<b>535 d</b> [E 60]	3,0	200	30 6D 4	09.04-03.07		<b>0 281 002 849</b>
		210	30 6D 5	03.07-02.10		<b>0 281 002 936</b>
<b>Serie 5 Touring</b>						
<b>520 d</b> [E 39]	2,0	100	20 4D 1 <M 47 D 20>	04.00-07.03	UPE	<b>0 928 400 527</b>
d [E 61]	2,0	110/120	20 4D 4 <M 47N>	09.05-02.08		<b>0 928 400 529</b>
		130	N47 D20...	09.07-02.10		<b>0 281 002 936</b>
				03.10-08.10		<b>0 281 006 147</b>
d [F 11]	2,0	135	N47 D20C <N47N>	09.10→		<b>0 281 006 092</b>
<b>525 d</b> [E 39]	2,5	120	25 6D 1	04.00-05.04	UPE	<b>0 928 400 527</b>
d [E 61]	2,5	120/130	25 6D 2	05.04-03.07		<b>0 928 400 529</b>
d, d xDrive, xd [E 61]	3,0	145	30 6D 3 <M 57N2>	03.07-08.10		<b>0 928 400 529</b>
<b>530 d</b> [E 39]	3,0	135-142	30 6D 1 <M 57 D 30>	08.98-05.04	UPE	<b>0 928 400 527</b>
d, d xDrive, xd [E 61]	3,0	160/170/173	30 6D 2 <M 57N>; 30 6D 3 <M 57N2>	05.04-08.10		<b>0 928 400 529</b>
<b>535 d</b> [E 61]	3,0	200	30 6D 4	09.04-03.07		<b>0 281 002 849</b>
		210	30 6D 5	03.07-02.10		<b>0 281 002 936</b>
				03.10-08.10		<b>0 281 006 147</b>
<b>Serie 6</b>						
<b>635 d</b> [E 63]	3,0	210	30 6D 5	09.07-02.10		<b>0 281 002 936</b>
				03.10-07.10		<b>0 281 006 147</b>
<b>Serie 6 Cabrio</b>						
<b>635 d</b> [E 64]	3,0	210	30 6D 5	09.07-02.10		<b>0 281 002 936</b>
				03.10-07.10		<b>0 281 006 147</b>
<b>Serie 7</b>						
<b>730 d</b> [E 38]	3,0	135-142	30 6D 1 <M 57 D 30>	08.98-12.01	UPE	<b>0 928 400 527</b>
d [E 65]	3,0	160/170	30 6D 2 <M 57N>; 30 6D 3 <M 57N2>	10.02-10.08		<b>0 928 400 529</b>
Ld [E 66]	3,0	170	30 6D 3 <M 57N2>	09.05-10.08		<b>0 928 400 529</b>
<b>740 d</b> [E 38]	3,9	180	39 8D 1 <M 67>	10.98-12.01		<b>0 280 217 124</b>
d [E 65]	3,9	190	39 8D 1	10.02-03.05		<b>0 281 006 146</b>
<b>745 d</b> [E 65]	4,4	220/242	44 8D 1	03.05-10.08		<b>0 281 006 146</b>





l/ccm



kW/(PS)



Typ



## CHEVROLET

**Captiva**

2.0 CDRI, CDRI 4x4 [KL1C,C100] 2,0 93/110 Z20S 10.06-02.11 0 281 002 683

**Lacetti**

2.0 D [KL1N, J200] 2,0 89 Z20S 09.06→ 0 281 002 683

**Nubira**

2.0 D [KL1N, J200] 2,0 89 Z20S 09.06-12.07 0 281 002 683

**Nubira Wagon**

2.0 D [KL1N, J200] 2,0 89 Z20S 09.06-12.07 0 281 002 683

## CHRYSLER

**PT Cruiser**

2.2 CRD [PT] 2,2 89-112 EDJ 09.02-12.09 0 281 002 571

**Voyager**

2.5 CRD, CRD 4x4 [RG] 2,5 105 ENC; ENJ 09.00-08.07 0 281 002 451

TD [ES] 2,5 85-87 VM HR 425 CLIEE &lt;ENC&gt; 04.95-12.95 0 281 002 132

TD [GS] 2,5 85 VM HR 425 CLIEE &lt;ENC&gt; 01.95-12.00 0 281 002 132

## CITROEN

**CX**

25 D Turbo 2 2,5 78 M25-671 01.87-12.92 0 281 002 037

**XM**

2.5 D Turbo [Y4] 2,5 94-96 THY &lt;DK5ATE&gt; 07.94-10.00 N05 0 281 002 128

## DODGE

**Caravan**

2.5 TD [NS] 2,5 85 VM HR 425 CLIEE &lt;ENC&gt; 01.95-08.03 0 281 002 132

## FIAT

**Albea**

1.3 JTD 16V [172..] 1,3 52 188 A 9.000 &lt;M40&gt; 07.03→ 0 281 002 613

**Brava**

1.9 JTD [182..] 1,9 76 182 B 4.000 &lt;M25&gt; 11.98-09.01 0 280 218 019

182 B 9.000 &lt;M26&gt; 08.00-09.01 0 281 002 309

TD [182..] 1,9 73/73,6 182 A 7.000 &lt;M8&gt;; 182 A 7.000 &lt;M21&gt; 03.96-09.01 0 281 002 144

**Bravo**

1.6 JTD [198] 1,6 66 198 A 6.000 03.10→ 0 281 002 917

77 198 A 3.000 03.10→ 0 281 002 917

88 198 A 2.000 03.10→ 0 281 002 917

JTD 8V [198] 1,6 77 198 A 3.000 &lt;M76&gt; 10.07-12.09 0 281 002 917

JTD 16V [198] 1,6 88 198 A 2.000 &lt;M78&gt; 03.08-12.09 0 281 002 917

1.9 JTD [182..] 1,9 76 182 B 4.000 &lt;M25&gt; 11.98-09.01 0 280 218 019

182 B 9.000 &lt;M26&gt; 08.00-09.01 0 281 002 309

JTD 8V [198] 1,9 66/85/ 192 A 8.000 &lt;M88&gt;; 192 B 4.000 &lt;M87&gt;; 03.07-06.07 0 281 002 792

88 192 B 5.000 &lt;M83&gt; 07.07-12.09 0 281 002 980

JTD 16V [198] 1,9 110 937 A 5.000 &lt;M92&gt; 07.07-12.09 0 281 002 980

TD [182..] 1,9 73/73,6 182 A 7.000 &lt;M8&gt;; 182 A 7.000 &lt;M21&gt; 03.96-09.01 0 281 002 144

2.0 JTD [198] 2,0 121 198 A 5.000 03.10→ 0 281 002 917

JTD 16V [198] 2,0 120 198 A 5.000 &lt;M120&gt; 10.08-12.09 0 281 002 917

**Croma**

1.9 JTD 8V, JTD 16V [194..] 1,9 85/88/ 939 A 1.000 &lt;M87&gt;; 939 A 1.000 &lt;M88&gt;; 06.05-12.10 0 281 002 683

100/110 939 A 1.000 &lt;M91&gt;; 939 A 2.000 &lt;M92&gt;

2.4 JTD [194..] 2,4 147 939 A 3.000 &lt;M95&gt; 06.05-12.10 0 281 006 048





◀ FIAT

<b>2.5 TDI [154..]</b>	2,5	85	8144.97Y (US87) <M5>	09.93-11.96	CSA	<b>0 281 002 088</b>
<b>Doblo</b>						
<b>1.3 JTD [119..]</b>	1,3	55/62	199 A 2.000 <M73>; 223 A 9.000 <M71>	10.05-06.07		<b>0 281 002 792</b>
				07.07-12.10		<b>0 281 002 980</b>
JTD 16V [119..]	1,3	51	188 A 9.000 <M20>	02.04-09.05		<b>0 281 002 613</b>
<b>1.6 JTD [152..]</b>	1,6	66		10.09→	SSJ	<b>0 281 002 917</b>
					SSJ	<b>0 281 006 054</b>
<b>1.9 JTD [119..]</b>	1,9	74	182 B 9.000 <M15>	10.01-01.04		<b>0 280 218 113</b>
		74/77	223 B 1.000 <M84>; 223 B 2.000 <M86>	10.05-12.10		<b>0 281 002 861</b>
		77	223 A 7.000 <M16/M30>	11.02-09.05		<b>0 280 218 113</b>
		88	186 A 9.000 <M88>	10.05-12.10		<b>0 281 002 861</b>
<b>Doblo Cargo</b>						
<b>1.3 JTD [223..]</b>	1,3	55/62	199 A 2.000 <M73>; 223 A 9.000 <M71>	10.05-06.07		<b>0 281 002 792</b>
				07.07-12.10		<b>0 281 002 980</b>
JTD 16V [223..]	1,3	51	188 A 9.000 <M20>	02.04-09.05		<b>0 281 002 613</b>
<b>1.6 JTD [263..]</b>	1,6	66		10.09→	SSJ	<b>0 281 002 917</b>
					SSJ	<b>0 281 006 054</b>
<b>1.9 JTD [223..]</b>	1,9	74	182 B 9.000 <M15>	10.01-01.04		<b>0 280 218 113</b>
		74/77	223 B 2.000 <M86>; 223 B 1000 <M84>	10.05-12.10		<b>0 281 002 861</b>
		77	223 A 7.000 <M16/M30>	11.02-09.05		<b>0 280 218 113</b>
		88	186 A 9.000 <M88>	10.05-12.10		<b>0 281 002 861</b>
<b>Fiorino</b>						
<b>1.3 MJTD [225..]</b>	1,3	55	199 A 2.000 <M73>	12.07→		<b>0 281 002 963</b>
<b>Idea</b>						
<b>1.3 JTD 16V [135..]</b>	1,3	52	188 A 9.000 <M30>	01.04→		<b>0 281 002 613</b>
		66	199 A 3.000 <M72>	11.04-10.07		<b>0 281 002 792</b>
				11.07→		<b>0 281 002 980</b>
<b>1.6 JTD 16V [135..]</b>	1,6	88	350 A 2.000 <M78>	04.08→		<b>0 281 002 917</b>
<b>1.9 JTD 8V [135..]</b>	1,9	74	188 B 2.000 <M40>	01.04-10.07		<b>0 281 002 683</b>
				11.07→		<b>0 281 002 861</b>
<b>Linea</b>						
<b>1.3 JTD [110..]</b>	1,3	63	199 A 3.000 <M70>	11.08→		<b>0 281 002 980</b>
		66	199 A 3.000 <M72>	03.07-06.07		<b>0 281 002 792</b>
				07.07→		<b>0 281 002 980</b>
<b>1.6 JTD [110..]</b>	1,6	77	198 A 3.000 <M76>	10.08→		<b>0 281 002 917</b>
<b>Marea</b>						
<b>1.9 JTD [185..]</b>	1,9	77	182 B 4.000 <M1>	03.99-09.02		<b>0 280 218 019</b>
		81	186 A 6.000 <M4>	08.00-09.02		<b>0 281 002 308</b>
JTD S.W. [185..]	1,9	74	182 B 9.000 <M5>	10.01-09.02		<b>0 281 002 309</b>
TD [185..]	1,9	73,6	182 A 7.000 <M1>	10.96-02.99		<b>0 281 002 144</b>
<b>2.4 JTD [185..]</b>	2,4	100	185 A 6.000 <M3>	03.99-09.02		<b>0 280 218 004</b>
TD [185..]	2,4	91	185 A 2.000 <M3>			
			Mot.Nr. →0918279	10.96-02.99		<b>0 281 002 185</b>
			Mot.Nr. 0918280→	10.96-02.99		<b>0 281 002 144</b>
<b>Marengo</b>						
<b>1.9 JTD [285..]</b>	1,9	77	182 B 4.000 <M1>	03.99-09.02		<b>0 280 218 019</b>
		81	186 A 6.000 <M4>	08.00-09.02		<b>0 281 002 308</b>
TD [285..]	1,9	73,6	182 A 7.000 <M1>	01.97-02.99		<b>0 281 002 144</b>
<b>Multipla</b>						
<b>1.9 JTD [186..]</b>	1,9	77	182 B 4.000 <M5>	01.99-12.00		<b>0 280 218 004</b>
		81	186 A 6.000 <M6>	08.00-03.02		<b>0 281 002 308</b>
		85	186 A 8.000 <M7/EU3>	04.02-10.03		<b>0 281 002 308</b>
				11.03-12.10		<b>0 280 218 120</b>
		85/88	186 A 8.000 <M87/EU4>; 186 A 9.000 <M88/EU4>	10.03-06.07		<b>0 281 002 792</b>
				07.07-12.10		<b>0 281 002 980</b>
<b>Palio</b>						
<b>1.3 JTD 16V [171..]</b>	1,3	52	188 A 9.000 <M40>	07.03→		<b>0 281 002 613</b>
<b>Palio Weekend</b>						
<b>1.9 JTD [173..]</b>	1,9	57/80	188 A 2.000 <M30>	10.01→		<b>0 281 002 308</b>
<b>Panda</b>						
<b>1.3 JTD [169..]</b>	1,3	55	169 A 1.000 <M73>	05.06-12.09		<b>0 281 002 792</b>
JTD, JTD 4x4 [169..]	1,3	52	188 A 8.000 <M10>	01.04-12.09		<b>0 281 002 613</b>





<b>Punto</b>						
1.3 MJTD 16V [188]	1,3	52	188 A 9.000 <M20>		07.03-12.10	0 281 002 613
1.9 JTD [188]	1,9	59/62,5	188 A 2.000 <M5>; 188 A 7.000 <M6>		07.99-06.03	0 281 002 309
JTD 8V [188]	1,9	63/74	188 A 7.000 <M25>; 188 B 2.000 <M30>		07.03-12.10	0 280 218 113
<b>Punto Evo</b>						
1.3 JTD [199]	1,3	55/66/ 70	199 A 2.000 <M73>; 199 A 3.000 <M72>; 199 B 1.000		10.09→ EU4 EU5	0 281 002 980 0 281 006 054
1.6 JTD [199]	1,6	88	955 A 3.000 <M78>		10.09→	0 281 006 054
<b>Punto Grande</b>						
1.3 MJTD [199]	1,3	55/66	199 A 2.000 <M73>; 199 A 3.000 <M72>		10.05-10.07 11.07→	0 281 002 792 0 281 002 980
1.6 JTD [199]	1,6	88	955 A 3.000 <M78>		08.08→	0 281 002 917
1.9 JTD [199]	1,9	85/88/ 96	199 A 5.000 <M89>; 939 A 1.000 <M88>; 939 A 7.000 <M87>		10.05-10.07 11.07→	0 281 002 683 0 281 002 861
<b>Punto VAN</b>						
1.3 MJTD 16V [288]	1,3	52	188 A 9.000 <M20>		07.03→	0 281 002 613
1.9 JTD [288]	1,9	85	188 A 7.000 <M6>		05.99-06.03	0 281 002 309
JTD 8V [288]	1,9	63	188 A 7.000 <M25>		07.03→	0 280 218 113
<b>Qubo</b>						
1.3 MJTD [300..]	1,3	55 70	199 A2.000 <M73> 199B1000		09.08→ 09.10→ EU5 EU5	0 281 002 963 0 281 006 054 0 281 002 963
<b>Stilo</b>						
1.9 JTD	1,9	85			06.02-12.07	0 281 002 308
JTD 8V [192..]	1,9	59/85 66	192 A 1.000 <M50>; 192 A 3.000 <M40> 192 B 5.000 <M83>		10.01-12.07 10.05-06.07 07.07-12.07	0 281 002 308 0 281 002 792 0 281 002 980
		74	192 A 9.000 <M45>		01.04-12.07	0 281 002 308
		88	192 A 8.000 <M88>		07.05-06.07 07.07-12.07	0 281 002 792 0 281 002 980
JTD 8V, JTD 16V [192..]	1,9	85/110	937 A 5.000 <M92>; 937 A 7.000 <M87>		07.05-06.07 07.07-12.07	0 281 002 792 0 281 002 980
JTD 16V [192..]	1,9	93 100 103	937 A 4.000 <M61> 192 B 1.000 <M62> 192 A 5.000 <M60>		01.04-12.07 01.04-12.07 01.04-12.07	0 280 218 120 0 280 218 120 0 280 218 120
<b>Stilo Multi Wagon</b>						
1.9 JTD 8V [192..]	1,9	59/85 66	192 A 1.000 <M50>; 192 A 3.000 <M40> 192 B 5.000 <M83>		10.02-12.07 10.05-06.07 07.07-12.07	0 281 002 308 0 281 002 792 0 281 002 980
		74	192 A 9.000 <M45>		09.04-12.07	0 281 002 308
		88	192 A 8.000 <M88>		07.05-06.07 07.07-12.07	0 281 002 792 0 281 002 980
JTD 8V, JTD 16V [192..]	1,9	85/110	937 A 5.000 <M92>; 937 A 7.000 <M87>		07.05-06.07 07.07-12.07	0 281 002 792 0 281 002 980
JTD 16V [192..]	1,9	93 100 103	937 A 4.000 <M61> 192 B 1.000 <M62> 192 A 5.000 <M60>		09.04-12.07 09.04-12.07 01.04-12.07	0 280 218 120 0 280 218 120 0 280 218 120
<b>Strada</b>						
1.3 JTD [278]	1,3	63	223 A 9.000 <M71>		07.05-06.07 07.07→	0 281 002 792 0 281 002 980
1.9 JTD [278]	1,9	59	188 A 2.000 <M50>		04.03-06.05	0 281 002 308
<b>500</b>						
1.3 MJTD [150]	1,3	55 70	169 A 1.000 <M73> 199 B 1.000 <M95>		07.07→ 01.10→	0 281 002 980 0 281 006 054
<b>500 Cabrio</b>						
1.3 MJTD [150]	1,3	55 70	169 A 1.000 199 B 1.000		07.09→ 01.10→	0 281 002 980 0 281 006 054





**FORD**

<b>Galaxy</b>						
1.9 TDi [00]	1,9	66	ANU <19NPD>	04.00-08.06		<b>0 281 002 757</b>
					WW	<b>0 280 217 121 0 986 280 202</b>
		85	AUY <19PPD>	04.00-08.06		<b>0 281 002 757</b>
					WW	<b>0 280 217 121 0 986 280 202</b>
		96	ASZ <19PPD>	01.03-08.06		<b>0 281 002 461 0 986 284 007</b>
		110	BTB <19PPD>	01.05-08.06		<b>0 281 002 461 0 986 284 007</b>
TDi [95]	1,9	66/81	AFN <D19P (VW 19P)>; AHU <D19N (VW 19N)>; ANU <D19TI (VW 19N PD)>; AVG <D19P (VW 19P)>	09.97-03.00		<b>0 281 002 757</b>
					WW	<b>0 280 217 121 0 986 280 202</b>
<b>Ka</b>						
1.3 TDi [08]	1,3	55	169 A... <Euro4/Euro5>	09.08-10.10		<b>0 281 002 980</b>

**HONDA**

<b>Accord Hatchback</b>						
2.0 TDi [CG/CH/CL]	2,0	77	20T2N	01.99-12.99	GS,TW	<b>0 281 002 120</b>
				01.99-10.00		<b>0 280 218 012</b>
<b>Accord Sedan</b>						
2.0 D Turbo [CE/CF]	2,0	77	20T2N	09.95-10.98		<b>0 281 002 120</b>
TDi [CG/CH/CL]	2,0	77	20T2N	01.99-12.99	GS,TW	<b>0 281 002 120</b>
				01.99-02.03		<b>0 280 218 012</b>
<b>Civic Aerodeck</b>						
2.0 D Turbo [MB/MC]	2,0	77	20T2N	04.98-12.99		<b>0 281 002 120</b>
<b>Civic Fastback</b>						
2.0 D [MB/MC]	2,0	63	20T2N	03.97-02.01		<b>0 281 002 120</b>
<b>Civic Hatchback</b>						
1.7 CTDi [EU/EP]	1,7	74	4EE2	01.02-12.05		<b>0 281 002 482</b>

**HYUNDAI**

<b>Accent</b>						
1.5 CDRi [MC]	1,5	81	D4FA <1.5L-U>	04.06→		<b>0 281 002 723</b>
CRDi [LC]	1,5	57-60	D3-EA	01.02-06.06		<b>0 281 002 528</b>
<b>Accent Hatchback</b>						
1.5 CDRi [MC]	1,5	81	D4FA <1.5L-U>	04.06→		<b>0 281 002 723</b>
CRDi [LC]	1,5	57-60	D3-EA	01.02-06.06		<b>0 281 002 528</b>
<b>Elantra</b>						
1.6 CRDi [HD]	1,6	85	D4FB <1C 1,6L-U>	08.06→		<b>0 281 002 723</b>
2.0 CRDi [XD]	2,0	83	D4EA <2.0L TCI>	06.01-08.06		<b>0 281 002 447</b>
<b>Elantra Hatchback</b>						
2.0 CRDi [XD]	2,0	83	D4EA <2.0L TCI>	06.01-08.06		<b>0 281 002 447</b>
<b>Getz</b>						
1.5 CRDi [TB]	1,5	60	D3-EA <TCI>	05.03-08.05		<b>0 281 002 528</b>
		65/81	D4FA <TDI>; D4FA-L <TDI>	09.05-06.09		<b>0 281 002 723</b>
<b>ix55</b>						
3.0 V6 CRDi 4x4 [EN]	3,0	176	D6EA <3L-S>	04.09→		<b>0 281 002 798</b>
<b>i10</b>						
1.1 CRDi [PA]	1,1	55	D3FA <1.1L-U>	03.08-12.10		<b>0 281 002 723</b>
<b>i20</b>						
1.4 CRDi [PB/PBT]	1,4	55/66	D4FC <1.4L-U/1.4L U2>	10.08→	SSJ	<b>0 281 002 723</b>
1.6 CRDi [PB/PBT]	1,6	85/94	D4FB <1.6L-U2>	01.09→		<b>0 281 002 723</b>
<b>i30</b>						
1.6 CRDi [FD/FDH]	1,6	66/85/94	D4FB <1.6L-U/1.6L-U2>; D4FB <1.6L-U2>	09.07→	TW	<b>0 281 002 723</b>
<b>i30 CW</b>						
1.6 CRDi [FD/FDH]	1,6	66/85/94	D4FB <1.6L-U/1.6L-U2>; D4FB <1.6L-U2>	02.08→	TW	<b>0 281 002 723</b>





<b>Matrix</b>					
1.5 CRDi [FC]	1,5	60	D3-EA <TCI>	07.01-01.06	<b>0 281 002 528</b>
		75	D4FA <TDI>	02.05-08.06	<b>0 281 002 669</b>
		81	D4FA-G <TDI>	09.06-04.10	<b>0 281 002 723</b>
<b>Santa Fe</b>					
2.0 CRDi	2,0	83	<DOHC>	06.00-08.03	<b>0 281 002 447</b>
CRDi, CRDi 4x4 [SM]	2,0	83	D4EA	01.01-12.05	<b>0 281 002 447</b>
<b>Terracan</b>					
2.9 CRDi	2,9	128	J3	02.01→	<b>0 281 002 554</b>
CRDi [HP]	2,9	110/120	J3	11.01-10.06	<b>0 281 002 554</b>
<b>Trajat</b>					
2.0 CRDi [FO]	2,0	83	D4EA	01.01-06.07	<b>0 281 002 447</b>
<b>Trajat XG</b>					
2.0 CRDi	2,0	83	D	10.99→	<b>0 281 002 447</b>
<b>Tucson</b>					
2.0 CRDi, CRDi 4x4 [JM]	2,0	83	D4EA	08.04-12.06 TW	<b>0 281 002 600</b>
		103	D4EA...	09.05-10.08 TW	<b>0 281 002 600</b>
		110	D4EA	01.09-03.10 TW	<b>0 281 002 600</b>

**IVECO**

<b>Massif</b>					
3.0	3,0	107/130	F1CE0481F*...; F1CE0481H*...	06.08→	<b>0 281 002 764</b>

**JEEP**

<b>Grand Cherokee</b>					
2.7 CRD [WG]	2,7	120	ENF	10.01-12.04	<b>0 281 002 501</b>

**KIA**

<b>Carens</b>					
2.0 CRDi, CRDi VGT [FC]	2,0	83/103	D4EA	04.02-12.06	<b>0 281 002 447</b>
CRDi, CRDi VGT [FG]	2,0	85/100/103	D4EA; D4EA-L; D4EA-W	09.06→	<b>0 281 002 721</b>
<b>Carens II</b>					
2.0 CRDi	2,0	85		02.02-04.06	<b>0 281 002 447</b>
<b>Carnival</b>					
2.9 CRDi [MB]	2,9	136	J3	04.06→	<b>0 281 002 721</b>
D Turbo [UP]	2,9	93	J3	06.98-09.01	<b>0 281 002 554</b>
<b>Carnival II</b>					
2.9 CRDi	2,9	107	J3	01.02-03.06	<b>0 281 002 554</b>
<b>Cee'd</b>					
1.6 CRDi [ED/FF2]	1,6	66/85/94	D4FB; D4FB-L	11.06→ SSJ	<b>0 281 002 723</b>
2.0 CRDi [ED/FF2]	2,0	103	D4EA-F	09.07→	<b>0 281 002 721</b>
<b>Cee'd Sporty Wagon</b>					
1.6 CRDi [ED/FF2]	1,6	66/85/94	D4FB; D4FB-L	09.07→ SSJ	<b>0 281 002 723</b>
2.0 CRDi [ED/FF2]	2,0	103	D4EA-F	09.07→	<b>0 281 002 721</b>
<b>Cerato</b>					
1.5 CRDi [FE]	1,5	75	D4FA	10.04-11.09 TW	<b>0 281 002 669</b>
					<b>0 281 002 723</b>
1.6 CRDi [FE]	1,6	85	D4FB	06.05-11.09	<b>0 281 002 723</b>
2.0 CRDi [FE]	2,0	83	D4EA	03.04-11.09	<b>0 281 002 669</b>
<b>Cerato Hatchback</b>					
1.5 CRDi [FE]	1,5	75	D4FA	03.04-11.09 TW	<b>0 281 002 669</b>
					<b>0 281 002 723</b>
1.6 CRDi [FE]	1,6	85	D4FB	06.05-11.09	<b>0 281 002 723</b>
2.0 CRDi [FE]	2,0	83	D4EA	03.04-11.09	<b>0 281 002 669</b>
<b>Magentis</b>					
2.0 CRDi [GE]	2,0	103/110	D4EA	02.06→	<b>0 281 002 721</b>





◀ KIA

<b>Mohave</b>						
3.0 CRDi	3,0	184	<3.0 S>		01.09→	<b>0 281 002 798</b>
<b>Picanto</b>						
1.1 CRDi [BA]	1,1	55	D3FA		11.05→	<b>0 281 002 765</b>
<b>Pro Cee'd</b>						
1.6 CRDi [ED]	1,6	66/85/94	D4FB; D4FB-FL		03.08→ SSJ	<b>0 281 002 723</b>
2.0 CRDi [ED]	2,0	103	D4EA		03.08→	<b>0 281 002 721</b>
<b>Rio</b>						
1.5 CRDi [DE]	1,5	81	D4FA		03.05→	<b>0 281 002 723</b>
<b>Rio Hatchback</b>						
1.5 CRDi [DE]	1,5	65/81	D4FA		03.05-09.11	<b>0 281 002 723</b>
<b>Sedona</b>						
2.9 D Turbo [UP]	2,9	93	J3		06.98-09.01	<b>0 281 002 554</b>
<b>Sorento</b>						
2.5 CRDi	2,5	107	<A2,51Gen>		05.00→	<b>0 281 002 554</b>
CRDi [JC]	2,5	103	D4CB		07.02-08.09	<b>0 281 002 554</b>
		125	D4CB		03.06-08.09	<b>0 281 002 721</b>
<b>Soul</b>						
1.6 CRDi [AM]	1,6	85/94	D4FB <Euro 4>		01.09-07.11	<b>0 281 002 723</b>
<b>Sportage</b>						
2.0 CRDi, CRDi 4x4 [JE]	2,0	83	D4EA		09.04-07.08	<b>0 281 002 600</b>
		100-103	D4EA...; D4EA-V		01.06-07.08	<b>0 281 002 721</b>
		110	D4EA		08.08-05.10 EU3	<b>0 281 002 600</b>
					EU4	<b>0 281 002 721</b>

**LANCIA**

<b>Delta</b>						
1.6 JTD [844]	1,6	88	198 A 2.000 <M78>		07.08→	<b>0 281 002 917</b>
1.9 JTD [844]	1,9	140	844 A 1.000 <M94>		08.08→	<b>0 280 218 237</b>
2.0 MJTD [844]	2,0	121	198 A 5.000 <M120>		08.08→	<b>0 281 002 917</b>
<b>Kappa Berlina</b>						
2.4 JTD [838]	2,4	100	838A8.000 <M3>		03.98-12.00	<b>0 280 218 019</b>
TD [838]	2,4	91	838A3.000 <M1>; 838A7.000 <M2>		11.94-03.98	<b>0 281 002 085</b>
<b>Kappa Station Wagon</b>						
2.4 D Turbo [838]	2,4	91	838A7.000 <M2>		06.96-03.98	<b>0 281 002 085</b>
JTD [838]	2,4	100	838A8.000 <M3>		03.98-12.00	<b>0 280 218 019</b>
<b>Lybra Berlina</b>						
1.9 JTD [839]	1,9	77	AR32302 <M1 CF2>		10.99-09.00	<b>0 280 218 019</b>
		80/85	AR37101 <M2 CF3>; 937A2.000 <M3 CF3>		09.00-11.06	<b>0 281 002 309</b>
2.4 JTD [839]	2,4	98	839A5.000/AR32501 <M6/M5 CF2>		10.99-09.00	<b>0 280 218 019</b>
		103	839A6.000 <M7 CF3>		09.00-05.02	<b>0 281 002 309</b>
		110	841C000 <M8 CF3>		06.02-09.03	<b>0 281 002 309</b>
					10.03-09.05	<b>0 280 218 113</b>
<b>Lybra Station Wagon</b>						
1.9 JTD [839]	1,9	77	AR32302 <M1 CF2>		10.99-09.00	<b>0 280 218 019</b>
		80/85	AR37101 <M2 CF3>; 937A2.000 <M3 CF3>		09.00-11.06	<b>0 281 002 309</b>
2.4 JTD [839]	2,4	98	839A5.000/AR32501 <M6/M5 CF2>		10.99-09.00	<b>0 280 218 019</b>
		103	839A6.000 <M7 CF3>		09.00-05.02	<b>0 281 002 309</b>
		110	841C000 <M8 CF3>		06.02-09.03	<b>0 281 002 309</b>
					10.03-09.05	<b>0 280 218 113</b>
<b>Musa</b>						
1.3 MJTD [184]	1,3	51	188A9000 <M30>		10.04→	<b>0 281 002 613</b>
MJTD 16V [184]	1,3	66	199A3000 <M72>		01.06-06.07	<b>0 281 002 792</b>
					07.07→	<b>0 281 002 980</b>
1.6 JTD [184]	1,6	85/88	350A2000 <M78>; 350A3000 <M77>		10.07→	<b>0 281 002 917</b>
1.9 JTD [184]	1,9	74	188B2000 <M40>		10.04→	<b>0 281 002 683</b>
<b>Thema Berlina</b>						
2.5 TD [104]	2,5	85	8144.97Y		01.93-11.94 CSA	<b>0 281 002 088</b>
<b>Thema Station Wagon</b>						
2.5 TD [104]	2,5	85	8144.97Y EDC-Bosch		01.93-11.94 CSA	<b>0 281 002 088</b>







Thesis						
2.4 JTD 10V [841]	2,4	110	841C.000 <M20>			
			Ricam.Nr →9518	04.02-09.03		0 281 002 309
			Ricam.Nr 9519→	10.03-02.05		0 280 218 113
JTD 20V [841]	2,4	120/129	841G.000 <M24>; 841H.000 <M25>; 841M.000 <M22>; 841N.000 <M23>	06.03-02.06		0 281 002 598
		136	841P.000 <M99 CF4>	03.06-12.09		0 281 006 048
Ypsilon						
1.3 JTD 16V [843]	1,3	51	188A9000 <M15>	06.03-09.06		0 281 002 613
Multijet 16V [843]	1,3	55	199A2000 <M73>	10.06-10.07	EU4	0 281 002 792
				10.06→	EU5	0 281 002 917
				11.07→	EU4	0 281 002 980
			199A2000 <M75>	10.09→	EU5	0 281 002 917
		66/77	199A3000 <M72>; 199A3000 <M105>	10.06-10.07	EU4	0 281 002 792
				10.06→	EU5	0 281 002 917
				11.07→	EU4	0 281 002 980
Multijet 16V [846]	1,3	70	199B1000	06.11→		0 281 006 054

**LAND ROVER GROUP**

Discovery I						
2.5 TDi	2,5	82-90	19L 21L 22L 300 Gemi	10.93-12.98		0 281 002 092
Freelander						
2.0 D [LN]	2,0	70-72	20T <L-Serie>	09.97-09.03	EDC	0 281 002 182
TD4 [LN]	2,0	80-82	204D3/TD4	09.01-03.07		0 928 400 520
Range Rover I						
2.5 TDi Classic	2,5	83	14L <200 TDi>	10.92-09.95		0 281 002 092

**MERCEDES-BENZ**

Serie A						
160 CDI [168]	1,7	44/55	OM 668.940 <DE 17 LA>; OM 668.941 <DE 17 A>			
			Mot.Nr. →30210110	09.98-08.04	SFU	0 281 002 281
			Mot.Nr. 30210111→	09.98-08.04	SFU	0 281 002 489
170 CDI [168]	1,7	66/70	OM 668.940 <DE 17 LA>; OM 668.942 <DE 17 LA>			
			Mot.Nr. →30210110	07.98-08.04	SFU	0 281 002 281
			Mot.Nr. 30210111→	07.98-08.04	SFU	0 281 002 489
Serie C						
30 AMG CDI [203]	3,0	170	OM 612.990 <DE 30 LA AMG>	01.03-08.04		0 281 002 535
200 CDI [202]	2,2	75	OM 611.960 <DE LA>			
			Mot.Nr. →30 055905	03.98-04.00		0 280 217 114
			Mot.Nr. 30 055906→	03.98-04.00		0 281 002 384
CDI [203]	2,2	75/90	OM 646.962 <DE 22 LA>	03.03-07.07		0 281 002 535
CDI [204]	2,1	100	OM 651.913 <D 22 LHD RED>			
			Komp.Nr. 064	04.08→	TW	0 281 002 535
	2,2	100	OM 646.81... <DE 22 LA LL EVO>	01.07-12.10		0 281 002 535
220 CDI [202]	2,2	92	OM 611.960 <DE LA>			
			Mot.Nr. →30 055905	12.97-04.00		0 280 217 114
			Mot.Nr. 30 055906→	12.97-04.00		0 281 002 384
CDI [203]	2,2	110	OM 646.963 <DE 22 LA>	03.03-02.07		0 281 002 535
CDI [204]	2,2	125	OM 646.811 <DE 22 LA LL EVO>	03.07-04.09		0 281 002 535
250 D Turbo [202]	2,5	110	OM 605.960 <AD 25 LA>	09.95-04.00		0 280 217 114
350 CDI [204]	3,0	170	OM 642.830 <D 30 LHD>	10.09-01.11		0 281 002 954
Serie C (Sportcoupe)						
30 AMG CDI [203]	3,0	170	OM 612.990 <DE 30 LA AMG>	09.02-08.04		0 281 002 535
200 CDI [203]	2,2	90	OM 646.962 <DE 22 LA>	03.03-02.08		0 281 002 535
220 CDI [203]	2,2	110	OM 646.963 <DE 22 LA>	03.03-02.08		0 281 002 535
Serie C (T-Modell)						
30 AMG CDI [203]	3,0	170	OM 612.990 <DE 30 LA AMG>	01.03-08.04		0 281 002 535





◀ MERCEDES-BENZ

<b>200 CDI [202]</b>	2,2	75	OM 611.960 <DE LA>			
			Mot.Nr. →30 055905	03.98-02.01		<b>0 280 217 114</b>
			Mot.Nr. 30 055906→	03.98-02.01		<b>0 281 002 384</b>
CDI [203]	2,2	75/90	OM 646.962 <DE 22 LA>	03.03-08.07		<b>0 281 002 535</b>
CDI [204]	2,1	100	OM 651.913 <DE 22 LHD RED>			
			<b>Komp.Nr. 064</b>	01.11→	TW	<b>0 281 002 535</b>
	2,2	100	OM 646.811 <DE 22 LA LL>	09.07-10.09		<b>0 281 002 535</b>
<b>220 CDI [202]</b>	2,2	92	OM 611.960 <DE LA>			
			Mot.Nr. →30 055905	12.97-02.01		<b>0 280 217 114</b>
			Mot.Nr. 30 055906→	12.97-02.01		<b>0 281 002 384</b>
CDI [203]	2,2	110	OM 646.963 <DE 22 LA>	03.03-08.07		<b>0 281 002 535</b>
CDI [204]	2,1	125	OM 646.811 <DE 22>	09.07-03.09		<b>0 281 002 535</b>
<b>250 D Turbo [202]</b>	2,5	110	OM 605.960 <AD 25 LA>	05.96-02.01		<b>0 280 217 114</b>
<b>Serie CLC</b>						
<b>200 CDI [203]</b>	2,2	90	OM 646.962 <DE 22 LA>	03.08-05.10		<b>0 281 002 535</b>
<b>220 CDI [203]</b>	2,2	110	OM 646.963 <DE 22 LA>	03.08-05.10		<b>0 281 002 535</b>
<b>Serie CLK (Coupé)</b>						
<b>220 CDI [209]</b>	2,1	110	OM 646.966 <DE 22 LA>	04.05-04.09		<b>0 281 002 535</b>
<b>Serie E</b>						
<b>200 CDI [210]</b>	2,1	85	OM 611.961 <DE LA>	07.99-08.99		<b>0 281 002 152</b>
	2,2	75	OM 611.961 <DE LA>	07.98-08.99		<b>0 281 002 152</b>
CDI [211]	2,1	75/90/ 100	OM 646.82... <DE 22 LA LL>; OM 646.951 <DE 22 LA>	07.02-03.09		<b>0 281 002 535</b>
<b>220 CDI [210]</b>	2,1	100-105	OM 611.961 <DE LA>	07.99-08.99		<b>0 281 002 152</b>
	2,2	92	OM 611.961 <DE LA>	07.98-05.99		<b>0 281 002 152</b>
CDI [211]	2,1	100/110/ 125	OM 646.821 <DE 22 LA LL>; OM 646.961 <DE 22 LA>	03.02-03.09		<b>0 281 002 535</b>
<b>270 CDI [211]</b>	2,7	130	OM 647.961 <DE 27 LA>	03.02-03.05		<b>0 281 002 535</b>
<b>280 CDI [211]</b>	3,2	130	OM 648.961 <DE 32 LA>	04.04-03.05		<b>0 281 002 535</b>
<b>290 D Turbo [210]</b>	2,9	95	OM 602.982 <DE LA>	01.96-05.99		<b>0 280 217 509</b>
<b>300 CDI [212]</b>	3,0	150	OM 642.850 <D 30 LHD REPO>	12.09-12.10		<b>0 281 002 954</b>
D Turbo [210]	3,0	130	OM 606.962 <D30 LA>	03.97-05.99		<b>0 281 002 152</b>
D Turbo 4MATIC [124]	3,0	108	OM 603.963	07.93-06.95		<b>0 281 002 024</b> <b>0 281 002 028</b>
<b>320 CDI [211]</b>	3,2	150	OM 648.961 <DE 32 LA>	11.02-08.06		<b>0 281 002 535</b>
<b>350 CDI [212]</b>	3,0	170	OM 642.850 <D 30 LL>	08.08-11.10	SCJ	<b>0 281 002 954</b>
<b>Serie E (Coupé)</b>						
<b>350 CDI [207]</b>	3,0	170	OM 642.836 <D 30>	02.09-03.11		<b>0 281 002 954</b>
<b>Serie E (T-Modell)</b>						
<b>200 CDI [211]</b>	2,1	100	OM 646.821 <DE 22 LA LL>	04.07-08.09		<b>0 281 002 535</b>
<b>220 CDI [210]</b>	2,1	100-105	OM 611.961 <DE LA>	07.99-08.99		<b>0 281 002 152</b>
	2,2	92	OM 611.961 <DE LA>	07.98-05.99		<b>0 281 002 152</b>
CDI [211]	2,1	100/110/ 125	OM 646.821 <DE 22 LA LL>; OM 646.961 <DE 22 LA>	02.03-08.09		<b>0 281 002 535</b>
<b>270 CDI [211]</b>	2,7	130	OM 647.961 <DE 27 LA>	02.03-03.05		<b>0 281 002 535</b>
<b>280 CDI [211]</b>	3,2	130	OM 648.961 <DE 32 LA>	04.04-03.05		<b>0 281 002 535</b>
<b>290 D Turbo [210]</b>	2,9	95	OM 602.982 <DE LA>	05.96-05.99		<b>0 280 217 509</b>
<b>300 CDI [212]</b>	3,0	150	OM 642.850 <D 30 LHD REPO>	12.09-12.10		<b>0 281 002 954</b>
D Turbo [210]	3,0	130	OM 606.962 <D30 LA>	03.97-05.99		<b>0 281 002 152</b>
D Turbo 4MATIC [124]	3,0	105-108	OM 603.963	07.93-05.96		<b>0 281 002 024</b> <b>0 281 002 028</b>
<b>320 CDI [211]</b>	3,2	150	OM 648.961 <DE 32 LA>	02.03-03.05		<b>0 281 002 535</b>
<b>350 CDI [212]</b>	3,0	170	OM 642.850 <D 30 LHD REPO>	08.09-11.10		<b>0 281 002 954</b>
CDI 4MATIC [212]	3,0	170	OM 642.856 <D 30 LHD REPO>	08.09-11.10	SCJ	<b>0 281 002 954</b>
<b>Serie ML</b>						
<b>300 CDI 4MATIC [164]</b>	3,0	150	OM 642.820 <D 30 LHD REPO>	05.09→		<b>0 281 002 954</b>
<b>350 CDI 4MATIC [164]</b>	3,0	170	OM 642.820 <D 30>	02.10→	SCJ	<b>0 281 002 954</b>
<b>Serie S</b>						
<b>300 SD Turbo [140]</b>	3,5	100-110	OM 603.971	09.91-08.93		<b>0 281 002 077</b>
SDL Turbo [126]	3,0	107-110	OM 603.961	11.85-08.87		<b>0 281 002 024</b> <b>0 281 002 028</b>
<b>320 CDI [220]</b>	3,2	150	OM 648.960 <DE 32 LA>	09.02-08.05		<b>0 281 002 535</b>



350 D Turbo [140]	3,5	100-110	OM 603.971	09.93-06.96	0 281 002 077
SDL Turbo [126]	3,5	100	OM 603.970	03.90-06.91	0 281 002 024
<b>Serie V</b>					
200 CDI [638 TON]	2,2	75	OM 611.980	06.99-09.03	0 280 217 114
220 CDI [638 TON]	2,2	90	OM 611.980	06.99-09.03	0 280 217 114
230 TD [638 TON]	2,3	72	OM 601.970	04.96-09.03	0 280 217 523
<b>Serie 124</b>					
250 D Turbo	2,5	93	OM 602.962	09.88-06.93	0 281 002 035
300 D Turbo, D Turbo 4MATIC	3,0	105-108	OM 603.960; OM 603.963	09.86-06.93	0 281 002 024
<b>Serie 124 (T-Modell)</b>					
300 D Turbo, D Turbo 4MATIC	3,0	105-108	OM 603.960; OM 603.963	09.86-06.93	0 281 002 024
<b>Serie 190</b>					
190 D 2.5 Turbo [201]	2,5	93	OM 602.961	09.86-08.93	0 281 002 035
<b>Vaneo</b>					
1.7 CDI [414]	1,7	55/67	OM 668.914 <DE 17 LA>		
			Mot.Nr. →30210110	02.02-08.05 SFU	0 281 002 281
			Mot.Nr. 30210111→	02.02-08.05 SFU	0 281 002 489
<b>Viano</b>					
2.0 CDI [639 TON]	2,1	80/85	OM 646.981 <OM 646 DE22LA>; OM 646.982 <OM 646 DE22LA (MOC2)>	09.03-08.10	0 281 002 585
2.2 CDI [639 TON]	2,1	110	OM 646.982 <OM 646 DE22LA>	09.03-08.10	0 281 002 585
3.0 CDI [639 TON]	3,0	150	OM 642.990 <OM 642 DE 30LA>		
			Fg.Nr. →298499	04.06-08.10 EUS	0 281 002 656
			Fg.Nr. 298500→	04.06-08.10 EUS	0 281 002 896

## MG

<b>ZR</b>					
2.0 D Turbo	2,0	74/82	20 T2N <L-Serie>	10.01-05.05	0 280 218 012
<b>ZS</b>					
2.0 TD	2,0	74	20 T2N <L-Serie>	10.01-05.05	0 280 218 012
<b>ZT</b>					
135 2.0 CDTi	2,0	96	20 4D 2 <M47R>	10.02-05.05	0 928 400 520
190 2.0 CDT	2,0	85	20 4D 2 <M47R>	10.01-05.05	0 928 400 520
<b>ZT-Tourer</b>					
135 2.0 CDTi	2,0	96	20 4D 2 <M47R>	10.02-05.05	0 928 400 520
190 2.0 CDT	2,0	85	20 4D 2 <M47R>	10.01-05.05	0 928 400 520

## MINI (BMW)

<b>Mini</b>					
Cooper D [R 56]	1,6	82	N47 C16A	09.10→	0 281 006 092
D, SD [R 56]	2,0	82/105	N47 C20A	03.11→	0 281 006 092
One D [R 56]	1,6	66	N47 C16A	09.10→	0 281 006 092
1.4 D [R 50]	1,4	55	1 ND <W17 D14A>	03.03-09.05	0 281 002 621
<b>Mini Cabrio</b>					
Cooper D [R 57]	1,6	82	N47 C16A	09.10→	0 281 006 092
D, SD [R 57]	2,0	82/105	N47 C20A	03.11→	0 281 006 092
<b>Mini Clubman</b>					
Cooper D [R 55]	1,6	82	N47 C16A	09.10→	0 281 006 092
D, SD [R 55]	2,0	82/105	N47 C20A	03.11→	0 281 006 092
One D [R 55]	1,6	66	N47 C16A	09.10→	0 281 006 092
<b>Mini Countryman</b>					
Cooper D, D ALL4 [R 60]	1,6	82	N47 C16A	09.10→	0 281 006 092
D, D ALL4, SD, SD ALL4 [R 60]	2,0	82/105	N47 C20A	03.11→	0 281 006 092
One D [R 60]	1,6	66	N47 C16A	09.10→	0 281 006 092
<b>Mini Coupé</b>					
Cooper SD [R 58]	2,0	105	N47 C20A	09.11→	0 281 006 092





**NISSAN**

<b>Almera Hatchback</b>							
2.2 D Turbo [N16E]	2,2	81	YD22DDT		01.00-02.03		0 280 218 005 0 986 280 232
<b>Almera Sedan</b>							
2.2 D Turbo [N16]	2,2	81	YD22DDT		04.00-03.01		0 280 218 005 0 986 280 232
D Turbo [N16E]	2,2	81	YD22DDT		03.01-02.03		0 280 218 005 0 986 280 232
<b>Almera Tino</b>							
2.2 D Turbo [V10M]	2,2	81-84	YD22DDTI		05.00-01.03		0 280 218 005 0 986 280 232
<b>Primera</b>							
2.2 D Turbo [P12E]	2,2	93	YD22DDT		12.01-06.04		0 280 218 005 0 986 280 232
<b>Primera Hatchback</b>							
2.0 D Turbo [P11E]	2,0	66	CD20T		10.97-12.01		0 281 002 207 0 986 284 012
2.2 D Turbo [P12E]	2,2	93	YD22DDT		05.02-06.04		0 280 218 005 0 986 280 232
<b>Primera Sedan</b>							
2.0 D Turbo [P11E]	2,0	66	CD20T		10.97-12.01		0 281 002 207 0 986 284 012
<b>Primera Wagon</b>							
2.0 D Turbo [WP11E]	2,0	66	CD20T		01.98-12.01		0 281 002 207 0 986 284 012
2.2 D Turbo [P12E]	2,2	93	YD22DDT		12.01-06.04		0 280 218 005 0 986 280 232
<b>Terrano II</b>							
2.7 D Turbo 4x4 [R20]	2,7	92	TD27TI		10.97→ GS		0 281 002 207 0 986 284 012
					11.98→		0 281 002 207 0 986 284 012
					10.00-02.02 GS		0 281 002 207 0 986 284 012
					GS,WW		0 281 002 440
					03.02-05.03		0 281 002 594
					06.03-12.06		0 281 002 597
3.0 D Turbo 4x4 [R20]	3,0	113	ZD30		02.02-12.04		0 281 002 594

**OPEL**

<b>Agila</b>							
1.3 CDTI [A]	1,3	51	Z 13 DT <Turbo>		08.03-02.08		0 281 002 619
<b>Antara</b>							
2.0 CDTI, CDTI 4x4	2,0	93/110	Z 20 DM <Ecotec>; Z 20 DMH; Z 20 DMH <Ecotec>		05.06→		0 281 002 683
<b>Astra</b>							
1.3 CDTI [H]	1,3	66	Z 13 DTH <Ecotec>		08.05-03.10		0 281 002 683
1.7 CDTI [G]	1,7	59	Z 17 DTL <Turbo>		03.03-01.04		0 281 002 549
CDTI [H]	1,7	59/74	Z 17 DTH <Turbo Ecotec>; Z 17 DTL <Turbo Ecotec>		03.04-03.07		0 281 002 683
CDTI [J]	1,7	81	A 17 DTJ <Ecotec>		09.09→		0 281 002 940
DT, DTI [G]	1,7	50/55	X 17 DTL <Turbo>; Y 17 DT <Turbo>		03.98-01.04		0 281 002 180
1.9 CDTI [H]	1,9	74/88/110	Z 19 DT <Turbo Ecotec>; Z 19 DTH <Turbo Ecotec>;		04.04-03.10		0 281 002 683
			Z 19 DTL <Turbo Ecotec>				
2.0 DT [G]	2,0	60	X 20 DTL <Turbo>		03.98-08.00		0 281 002 180
			Y 20 DTH <Turbo>				
			Fg.Nr. →Y2999999 →Y5999999		09.99-01.05		0 281 002 180
			→Y6999999 →Y8999999 →YH999999				
			Fg.Nr. 12000001→22999999		09.99-01.05		0 281 002 428
			15000001→25999999				
			16000001→26999999				
			18000001→28999999				
			1H000001→2B999999 →2H999999				
			Fg.Nr. 32000001→35000001→36000001→		09.99-01.05		0 281 002 478
			38000001→3B000001→3H000001→				
DTL [G]	2,0	60	Y 20 DTL <Turbo>				
			Fg.Nr. →Y2999999 →Y5999999		09.00-01.04		0 281 002 180
			→Y6999999 →Y8999999 →YH999999				
			Fg.Nr. 12000001→15000001→		09.00-01.04		0 281 002 428
			16000001→18000001→1H000001→				
2.2 DTI [G]	2,2	92	Y 22 DTR <Turbo>		09.01-01.04		0 281 002 478





<b>Astra Cabrio</b>						
1.7 CDTi [G]	1,7	59	Z 17 DTL <Turbo>		03.03-08.05	<b>0 281 002 549</b>
2.2 DTi [G]	2,2	92	Y 22 DTR <Turbo>		03.02-08.05	<b>0 281 002 478</b>
<b>Astra Caravan</b>						
1.3 CDTi [H]	1,3	66	Z 13 DTH <Ecotec>		08.05-03.10	<b>0 281 002 683</b>
1.7 CDTi [G]	1,7	59	Z 17 DTL <Turbo>		03.03-06.04	<b>0 281 002 549</b>
CDTi [H]	1,7	59/74	Z 17 DTH <Turbo Ecotec>; Z 17 DTL <Turbo Ecotec>		08.04-03.07	<b>0 281 002 683</b>
DT, DTi [G]	1,7	50/55	X 17 DTL <Turbo>; Y 17 DT <Ecotec Turbo>		03.98-06.04	<b>0 281 002 180</b>
1.9 CDTi [H]	1,9	74/88/ 110	Z 19 DT <Turbo Ecotec>; Z 19 DTH <Turbo Ecotec>; Z 19 DTL <Turbo Ecotec>		09.04-07.10	<b>0 281 002 683</b>
2.0 DT [G]	2,0	60	X 20 DTL <Turbo>		03.98-08.00	<b>0 281 002 180</b>
DTi [G]	2,0	74	Y 20 DTH <Turbo>			
			Fg.Nr. →Y2999999 →Y5999999 →Y6999999 →Y8999999 →YH999999		09.00-06.04	<b>0 281 002 180</b>
			Fg.Nr. 12000001→22999999 15000001→25999999 16000001→26999999 18000001→28999999 1H000001→2B999999 →2H999999		09.00-06.04	<b>0 281 002 428</b>
			Fg.Nr. 32000001→ 35000001→ 36000001→ 38000001→ 3B000001→ 3H000001→		09.00-06.04	<b>0 281 002 478</b>
DTL [G]	2,0	60	Y 20 DTL <Turbo>			
			Fg.Nr. →Y2999999 →Y5999999 →Y6999999 →Y8999999 →YH999999		09.00-06.04	<b>0 281 002 180</b>
			Fg.Nr. 12000001→ 15000001→ 16000001→ 18000001→ 1H000001→		09.00-06.04	<b>0 281 002 428</b>
2.2 DTi [G]	2,2	92	Y 22 DTR <Turbo>		09.01-06.04	<b>0 281 002 478</b>
<b>Astra Coupé</b>						
1.7 CDTi [G]	1,7	59	Z 17 DTL <Turbo>		03.03-02.05	<b>0 281 002 549</b>
2.2 DTi [G]	2,2	92	Y 22 DTR <Turbo>		03.02-02.05	<b>0 281 002 478</b>
<b>Astra GTC</b>						
1.3 CDTi [H]	1,3	66	Z 13 DTH <Ecotec>		06.05-02.09	<b>0 281 002 683</b>
1.7 [J]	1,7	81/96	A 17 DTC <ecoFlex>; A 17 DTS <ecoFlex>		11.11→	<b>0 280 218 254</b>
CDTi [H]	1,7	59/74	Z 17 DTH <Turbo Ecotec>; Z 17 DTL <Turbo Ecotec>		03.05-03.07	<b>0 281 002 683</b>
1.9 , CDTi [H]	1,9	74/88/ 110	Z 19 DT <Turbo Ecotec>; Z 19 DTH <Turbo Ecotec>; Z 19 DTJ <Turbo Ecotec>; Z 19 DTL <Turbo Ecotec>		03.05-07.10	<b>0 281 002 683</b>
<b>Astra Sports Tourer</b>						
1.3 CDTi [J]	1,2	67-70	A 13 DTE <ecoFlex>		09.10→	<b>0 281 002 940</b>
<b>Astra TwinTop</b>						
1.9 CDTi [H]	1,9	110	Z 19 DTH <Ecotec>		09.05→	<b>0 281 002 683</b>
<b>Combo</b>						
1.3 CDTi [Tour]	1,3	51	Y 13 DT <Ecotec>; Z 13 DT <Ecotec>		09.04-09.07	<b>0 281 002 549</b>
		55	Z 13 DTJ <Ecotec>		10.05→	<b>0 281 002 683</b>
1.7 CDTi [Tour]	1,7	74	Z 17 DTH <Turbo>		09.04→	<b>0 281 002 549</b>
DI, DTi [Tour]	1,7	48/55	Y 17 DT <Turbo>; Y 17 DTL <Turbo>		10.01-08.04	<b>0 281 002 180</b>
<b>Corsa</b>						
1.3 CDTi [C]	1,3	51	Y 13 DT <Ecotec>; Z 13 DT <Ecotec>		09.03-09.06	<b>0 281 002 549</b>
		55	Z 13 DTJ <Ecotec>		09.05-09.06	<b>0 281 002 683</b>
CDTi [D]	1,2	55/66	Z 13 DTH <Ecotec>; Z 13 DTJ <Ecotec>		07.06→	<b>0 281 002 683</b>
		66	A 13 DTH <Ecotec>		10.06-02.09	<b>0 281 002 683</b>
		70	A 13 DTR; Z 13 DTE		12.09→	<b>0 281 002 940</b>
1.7 CDTi [C]	1,7	74	Z 17 DTH		09.03-09.06	<b>0 281 002 549</b>
CDTi, DTi	1,7	55/74-75	Y 17 DTL; Z 17 DTH		10.02-12.06	<b>0 281 002 180</b>
DI [C]	1,7	48	Y 17 DTL		09.00-08.03	<b>0 281 002 180</b>
DTi [C]	1,7	55	Y 17 DT		09.00-08.03	<b>0 281 002 180</b>
DTi Utility [C]	1,7	55	Y 17 DT		10.02-06.10	<b>0 281 002 180</b>
<b>Frontera</b>						
2.2 DTi [B]	2,2	85	X 22 DTH <Turbo>		09.98-10.02	<b>0 281 002 184</b>
		88	Y 22 DTH <Turbo>		09.02-09.04	<b>0 281 002 479</b>
2.3 TD [A]	2,3	74	23 DT <Turbo>		09.91-08.95	<b>0 281 002 144</b>
2.5 TDS Turbo [A]	2,5	85	VM 41 B <Venturi-25TD>		06.96-08.98	<b>0 281 002 144</b>





◀ OPEL

Insignia						
2.0 CDTI, CDTI 4x4 [68]	2,0	81/96/118/140	A 20 D... <ecoFlex>; A 20 DT... <Ecotec>; A 20 DTH <ecoFlex>; A 20 DTR <Ecotec>	09.08→		<b>0 281 002 912</b>
CDTI, CDTI 4x4 [69]	2,0	81/96/118/140	A 20 D... <ecoFlex>; A 20 DT... <Ecotec>; A 20 DTH <ecoFlex>; A 20 DTR <Ecotec>	09.08→		<b>0 281 002 912</b>
Insignia Sports Tourer						
2.0 CDTI, CDTI 4x4 [35]	2,0	81/96/118/140	A 20 D... <ecoFlex>; A 20 DT... <Ecotec>; A 20 DTH <ecoFlex>; A 20 DTR <Ecotec>	02.09→		<b>0 281 002 912</b>
Meriva						
1.3 CDTI [A]	1,3	55	Y 13 DT <Ecotec>; Z 13 DT <Ecotec>	04.05-03.10		<b>0 281 002 620</b>
			Z 13 DTJ <Ecotec>	09.03-03.10		<b>0 281 002 802</b>
CDTI [B]	1,2	55/70	A 13 DTC <Ecotec>; A 13 DTE <ecoFLEX>	04.10→		<b>0 281 002 940</b>
1.7 CDTI [A]	1,7	74	Z 17 DTH <Turbo Ecotec (EE4)>	09.03-09.09		<b>0 281 002 620</b>
		92	Z 17 D... <MT-6>	09.06-03.10		<b>0 281 002 830</b>
CDTI [B]	1,7	74/81/96	A 17 DT <Ecotec>; A 17 DTC <Ecotec>; A 17 DTS <Ecotec>	06.10→		<b>0 281 002 940</b>
DTI [A]	1,7	55	Y 17 DT <Turbo (EE4)>	03.03-09.05		<b>0 281 002 579</b>
Omega						
2.0 DTI Turbo [B]	2,0	74	X 20 DTH	09.97-08.00		<b>0 281 002 180</b>
2.2 DTI [B]	2,2	88	Y 22 DTH <Turbo>	06.00-07.03		<b>0 281 002 428</b>
2.5 DTI Turbo [B]	2,5	110	Y 25 TD	06.01-09.03		<b>0 281 002 564</b>
Signum						
1.9 CDTI	1,9	74/88/110	Z 19 DT <Ecotec>; Z 19 DTH <Ecotec>; Z 19 DTL <Ecotec>	04.04-09.08		<b>0 281 002 683</b>
2.0 DTI	2,0	74	Y 20 DTH <Ecotec>	05.03-09.05		<b>0 281 002 479</b>
2.2 DTI	2,2	86-92	Y 22 DTR <Ecotec>	05.03-09.05		<b>0 281 002 479</b>
3.0 CDTI	3,0	130-135	Y 30 DT <Ecotec>	05.03-09.05		<b>0 281 002 605</b>
			Z 30 DT <Ecotec>	09.05-09.08		<b>0 281 002 773</b>
Sintra						
2.2 TD	2,2	85	X 22 DTH <Turbo>	09.97-09.99		<b>0 281 002 184</b>
Tigra TwinTop						
1.3 CDTI [B]	1,3	51	Z 13 DT <Turbo Ecotec>	06.04-03.09		<b>0 281 002 549</b>
Vectra						
1.9 CDTI, CDTI GTS [C]	1,9	74/88/110	Z 19 DT <Ecotec>; Z 19 DTH <Ecotec>; Z 19 DTL <Ecotec>	04.04-10.08		<b>0 281 002 683</b>
2.0 DI [B]	2,0	60	X 20 DTL <Ecotec 16V Turbo>; X 20 DTL 16V Turbo <Ecotec>			
			Fg.Nr. W1000001→	09.96-08.02		<b>0 281 002 180</b>
			Fg.Nr. →V7999999	09.96-08.02		<b>0 281 002 139</b>
DTI [B]	2,0	74	X 20 DTH	09.97-08.03		<b>0 281 002 180</b>
			Y 20 DTH	09.00-09.03		<b>0 281 002 428</b>
DTI, DTI GTS [C]	2,0	74	Y 20 DTH <Ecotec>	04.02-09.05		<b>0 281 002 479</b>
2.2 DTI [B]	2,2	92	Y 22 DTR <Ecotec>	09.00-09.03		<b>0 281 002 428</b>
DTI, DTI GTS [C]	2,2	86-92	Y 22 DTR <Turbo Ecotec>	04.02-09.05		<b>0 281 002 479</b>
3.0 CDTI, CDTI GTS [C]	3,0	130	Y 30 DT <Ecotec>	03.03-08.05		<b>0 281 002 605</b>
		135	Z 30 DT <Ecotec>	08.05-10.08		<b>0 281 002 773</b>
Vectra Caravan						
1.9 CDTI [C]	1,9	74/88/110	Z 19 DT <Ecotec>; Z 19 DTH <Ecotec>; Z 19 DTL <Ecotec>	04.04-10.08		<b>0 281 002 683</b>
2.0 DI [B]	2,0	60	X 20 DTL <16V Turbo Ecotec>			
			Fg.Nr. W1000001→	09.96-08.00		<b>0 281 002 180</b>
			Fg.Nr. →V7999999	09.96-08.00		<b>0 281 002 139</b>
DTI [B]	2,0	74	X 20 DTH	09.97-08.03		<b>0 281 002 180</b>
			Y 20 DTH	09.00-09.03		<b>0 281 002 428</b>
DTI [C]	2,0	74	Y 20 DTH <Turbo Ecotec>	09.03-09.05		<b>0 281 002 479</b>
2.2 DTI [B]	2,2	92	Y 22 DTR <Ecotec>	09.00-09.03		<b>0 281 002 428</b>
DTI [C]	2,2	86-92	Y 22 DTR <Turbo Ecotec>	09.03-09.05		<b>0 281 002 479</b>



<b>3.0 CDTi [C]</b>	3,0	130	Y 30 DT <Turbo Ecotec>	09.03-08.05	<b>0 281 002 605</b>
		135	Z 30 DT <Turbo Ecotec>	08.05-10.08	<b>0 281 002 773</b>
<b>Zafira</b>					
<b>2.0 DI [A]</b>	2,0	60	X 20 DTL <Turbo>		
			Fg.Nr. →Y8999999 →YT999999	03.99-08.00	<b>0 281 002 180</b>
			Fg.Nr. 12000001 → 1T000001 →	03.99-08.00	<b>0 281 002 428</b>
<b>DTI [A]</b>	2,0	74	Y 20 DTH <Turbo>		
			Fg.Nr. →Y2999999 →Y5999999	04.99-07.05	<b>0 281 002 180</b>
			→Y6999999 →Y8999999 →YH999999		
			Fg.Nr. 12000001 → 22999999	04.99-07.05	<b>0 281 002 428</b>
			15000001 → 25999999		
			16000001 → 26999999		
			18000001 → 28999999		
			1H000001 → 2H999999		
			Fg.Nr. 32000001 → 35000001 → 36000001 →	04.99-07.05	<b>0 281 002 478</b>
			38000001 → 3H000001 → 3H000001 →		
<b>2.2 DTI [A]</b>	2,2	92	Y 22 DTR <Turbo>	03.02-07.05	<b>0 281 002 478</b>

**PEUGEOT**

<b>505</b>					
<b>2.3 D Turbo</b>	2,3	54-59	147 <XD2S>	09.83-06.86	<b>0 281 002 008</b>
<b>2.5 D Turbo</b>	2,5	66-70	152A, 152Y <XD3T>	10.83-12.93	<b>0 281 002 008</b>
		77	152B <XD3TE>	10.86-12.93	<b>0 281 002 029</b>
<b>605</b>					
<b>2.5 D Turbo [Y30]</b>	2,5	94-96	THY <DK5ATE>	07.94-05.99	<b>0 281 002 128</b>

**RENAULT**

<b>Megane I</b>					
<b>1.9 DTI [X64]</b>	1,9	69	F9Q 730	06.97-02.99	<b>0 281 002 195</b>
<b>Megane I Classic</b>					
<b>1.9 DTI [X64]</b>	1,9	72	F9Q 730	08.97-09.03	<b>0 281 002 195</b>

**ROVER**

<b>Serie 200</b>					
<b>220 SD, SDI</b>	2,0	63/77	20 T2N <TCie>; 20 T2R <TCie-M>		
			Fg.Nr. YD 471565 →	09.95-03.00	<b>0 280 218 012</b>
			Fg.Nr. →YD 471564	09.95-03.00	<b>0 281 002 120</b>
<b>Serie 400</b>					
<b>420 SD, SDI</b>	2,0	63/77	20 T2N <Serie-L>; 20 T2R <Serie-L>		
			Fg.Nr. YD 471064 →	10.95-03.00	<b>0 280 218 012</b>
			Fg.Nr. →YD 471063	10.95-03.00	<b>0 281 002 120</b>
<b>Serie 600</b>					
<b>620 SDi</b>	2,0	77	20 T2N <SERIE-L>	03.95-12.98 BO	<b>0 281 002 120</b>
<b>Serie 800</b>					
<b>825 TD</b>	2,5	92	VM-425-CLIER	01.96-12.98	<b>0 281 002 120</b>
<b>25</b>					
<b>2.0 iDT</b>	2,0	74/83	20 T2N <L-Serie>		
			Fg.Nr. YD 471565 →	02.00-05.05	<b>0 280 218 012</b>
			Fg.Nr. →YD 471564	02.00-05.05	<b>0 281 002 120</b>
<b>45</b>					
<b>2.0 iDT</b>	2,0	74/83	20 T2N <L-Serie>		
			Fg.Nr. YD 471064 →	02.00-05.05	<b>0 280 218 012</b>
			Fg.Nr. →YD 471063	02.00-05.05	<b>0 281 002 120</b>
<b>75</b>					
<b>2.0 CDT, CDTi</b>	2,0	85/96	20 4D 2 <M 47 D 20>	01.99-05.05	<b>0 928 400 520</b>
<b>75 Tourer</b>					
<b>2.0 CDT, CDTi</b>	2,0	85/96	20 4D 2 <M 47 D 20>	01.01-05.05	<b>0 928 400 520</b>





**SAAB (SAAB AUTOMOBILE AB)**

9-3						
1.9 TiD [9440]	1,9	88/110	Z19DT; Z19DTH		09.04→	0 281 002 683
TTiD [9440]	1,9	96/118	A19DTR (130); A19DTR (160)		09.10→	0 281 002 764
		132	Z19DTR		02.08→	0 281 002 764
2.2 16VD Turbo [9400]	2,2	85/92	D223L <X 22 DTH>; D223L <Y 22 DTH>			
			Fg.Nr. →12020000		03.98-09.02	0 281 002 212
			Fg.Nr. 12020001→		03.98-09.02	0 281 002 443
9-3 Cabriolet						
1.9 TiD [9440]	1,9	110	Z19DTH		01.06→	0 281 002 683
TTiD [9440]	1,9	118	A19DTR (160)		09.10→	0 281 002 764
		132	Z19DTR		02.08→	0 281 002 764
9-3 Coupé						
2.2 16VD Turbo [9400]	2,2	92	D223L <Y 22 DTH>			
			Fg.Nr. →12020000		11.00-09.02	0 281 002 212
			Fg.Nr. 12020001→		11.00-09.02	0 281 002 443
9-3 Kombi						
1.9 TiD [9440]	1,9	88/110	Z19DT; Z19DTH		03.05→	0 281 002 683
TTiD [9440]	1,9	96/118	A19DTR (130); A19DTR (160)		09.10→	0 281 002 764
		132	Z19DTR		02.08→	0 281 002 764
9-3X						
1.9 TTiD	1,9	132	Z19DTR		03.10→	0 281 002 764
9-5						
1.9 TiD [9600]	1,9	110	Z19DTH		09.05-02.10	0 281 002 683
2.0 TiD4, TTiD4, TTiD4 XWD [650]	2,0	118/140	A 20 DTH; A 20 DTR		03.10→	0 281 002 912
2.2 TiD [9600]	2,2	88	D223L		03.02-08.05	0 281 002 538
3.0 TiD [9600]	3,0	130	D308L			
			Fg.Nr. →330027123 →33029139		09.01-08.05	0 281 002 538
			Fg.Nr. 330027124→ 33029140→		09.01-08.05	0 281 002 605
9-5 Kombi						
1.9 TiD [9600]	1,9	110/129	Z19DTH		01.06-02.10	0 281 002 683
2.2 TiD [9600]	2,2	88	D223L		03.02-08.05	0 281 002 538
3.0 TiD [9600]	3,0	130	D308L			
			Fg.Nr. →330027123 →33029139		09.01-08.05	0 281 002 538
			Fg.Nr. 330027124→ 33029140→		09.01-08.05	0 281 002 605

**SEAT**

Alhambra						
1.9 TDI [7V8]	1,9	66/81	AFN; AHU			
			Fg.Nr. 7M..W..507 042→		09.97-02.00	0 281 002 757
					WW	0 280 217 121 0 986 280 202
		81	AVG		09.97-02.00	0 281 002 757
TDI [7V9]	1,9	66	ANU		06.00-03.10	0 281 002 757
					WW	0 280 217 121 0 986 280 202
		110	BTB		06.05-05.07	0 281 002 461 0 986 284 007
TDI, TDI 4Motion [7V9]	1,9	85	AUY		06.00-03.10	0 281 002 757
					WW	0 280 217 121 0 986 280 202
			BVK		11.05-03.10	0 281 002 531 0 986 284 009
		96	ASZ		11.02-11.08	0 281 002 461 0 986 284 007
2.0 TDI [7V9]	2,0	103	BRT		11.05-03.10	0 281 002 461 0 986 284 007
TDI, TDI 4WD [710]	2,0	85/100/103/125	CFFA; CFFB; CFFB <D91>; CFFE <DE4>; CFFB		05.10→	0 281 002 956
Altea						
1.9 TDI [5P1]	1,9	66/77	BJB; BKC; BLS <D3W>; BXE <D3W>; BXF <MF7>		04.04-12.10	0 281 002 531 0 986 284 009
2.0 TDI [5P1]	2,0	100/103/125	AZV; BKD <D3X>; BMM <D7N>; BMN		03.04-07.11	0 281 002 461 0 986 284 007
		103	CFHC <D91>		09.10→	0 281 002 956
		125	CEGA <D93>		03.09-05.10	0 281 002 735





<b>Altea Freetrack</b>							
2.0 TDI, TDI 4WD [5P5/5P8]	2,0	103/125	BMM <D7N>; BMN		06.07-10.10	0 281 002 461	0 986 284 007
TDI 4WD [5P5/5P8]	2,0	103/125	CFHC <D91>; CFJA <D93>		09.10→	0 281 002 956	
		125	CEGA <D93>		03.09-10.10	0 281 002 735	
<b>Altea XL</b>							
1.9 TDI [5P5]	1,9	66/77	BLS <D3W>; BXE <D3W>; BXF <MF7>		10.06-12.10	0 281 002 531	0 986 284 009
2.0 TDI [5P5]	2,0	100/103/125	AZV; BKD <D3X>; BMM <D7N>; BMN		05.06-09.11	0 281 002 461	0 986 284 007
		103	CFHC <D91>		10.10→	0 281 002 956	
		125	CEGA <D93>		03.09-05.10	0 281 002 735	
<b>Arosa</b>							
1.4 TDI [6H1]	1,4	55	AMF		01.98-06.04	0 281 002 318	0 986 284 002
<b>Cordoba</b>							
1.4 TDI [6L2]	1,4	51/55/58/59	AMF; BMS; BNM; BNV		10.02-11.09	0 281 002 531	0 986 284 009
1.9 TDI [6K2]	1,9	66/81	AGR; ALH; ASV		05.99→	0 281 002 216	0 986 284 001
TDI [6L2]	1,9	74	ATD; AXR		09.02→	0 281 002 531	0 986 284 009
			BMT		09.06-11.09	0 281 002 531	0 986 284 009
		96	ASZ		10.02-09.05	0 281 002 461	0 986 284 007
			BLT		05.05→	0 281 002 461	0 986 284 007
<b>Cordoba Vario</b>							
1.9 TDI [6K5]	1,9	66/81	AGR; ALH; ASV		05.99-08.02	0 281 002 216	0 986 284 001
<b>Exeo</b>							
2.0 TDI [3R2]	2,0	88/105/125	CAGA <D92>; CAGC <D90>; CAHA <D93>		12.08→	0 281 002 735	
<b>Exeo ST</b>							
2.0 TDI [3R5]	2,0	88/105/125	CAGA <D92>; CAGC <D90>; CAHA <D93>		06.09→	0 281 002 735	
<b>Ibiza</b>							
1.2 TDI [6J5]	1,2	55	CFWA <D28>		06.10→	0 281 006 132	
1.4 TDI [6J5]	1,4	59	BMS <D4T>		08.08-06.10	0 281 002 531	0 986 284 009
TDI [6L1]	1,4	51/55/59	AMF; BMS; BNM; BNV		05.02-11.09	0 281 002 531	0 986 284 009
1.9 TDI [6J5]	1,9	66/77	BLS <D3W>; BXJ		02.08-06.10	0 281 002 531	0 986 284 009
TDI [6K1]	1,9	66/81	AGR; ALH; ASV		05.99-05.02	0 281 002 216	0 986 284 001
TDI [6L1]	1,9	74	ATD				
			Fg.Nr. →6L..2..050 000		09.01-03.02	0 281 002 757	
						WW	0 280 217 121 0 986 280 202
			Fg.Nr. 6L..2..050 001→		04.02-05.05	0 281 002 531	0 986 284 009
			AXR		05.05-11.09	0 281 002 531	0 986 284 009
			BMT		09.06-11.09	0 281 002 531	0 986 284 009
		96	ASZ		11.01-09.05	0 281 002 461	0 986 284 007
			BLT		05.05-11.09	0 281 002 461	0 986 284 007
TDI Cupra R [6L1]	1,9	118	BPX; BUK		03.04-02.08	0 281 002 461	0 986 284 007
2.0 TDI [6J5]	2,0	105	CFHD <D92>		01.10→	0 281 002 956	
<b>Ibiza Sportcoupé</b>							
1.2 TDI [6J1]	1,2	55	CFWA <D28>		05.10→	0 281 006 132	
1.4 TDI [6J1]	1,4	59	BMS <D4T>		07.08-06.10	0 281 002 531	0 986 284 009
1.9 TDI [6J1]	1,9	66/77	BLS <D3W>; BXJ		02.08-06.10	0 281 002 531	0 986 284 009
2.0 TDI [6J1]	2,0	105	CFHD <D92>		01.10→	0 281 002 956	
<b>Ibiza ST</b>							
1.2 TDI [6J8]	1,2	55	CFWA <D28>		04.10→	0 281 006 132	
<b>Leon</b>							
1.9 TDI [1M1]	1,9	66	AGR		12.99-09.02	0 281 002 757	
						WW	0 280 217 121 0 986 280 202
			ALH		03.99-07.04	0BD,WW	0 280 217 121 0 986 280 202
			PR-Nr. OGD		03.99-07.04	0BD	0 281 002 757
			PR-Nr. OGE				
			PR-Nr. OGZ		03.99-07.04	OBD	0 281 002 531 0 986 284 009
		74	AXR		10.05-06.06	0 281 002 531	0 986 284 009
		81	AHF		10.98-09.02	WW	0 280 217 121 0 986 280 202
					04.99-09.02	0 281 002 757	



◀ SEAT

1.9 TDI [1M1]	1,9	81	ASV	10.99-10.05	ØBD, WW	0 280 217 121	0 986 280 202
			PR-Nr. OGD	10.99-10.05	ØBD	0 281 002 757	
			PR-Nr. OGE				
			PR-Nr. OGZ	10.99-10.05	ØBD	0 281 002 531	0 986 284 009
		96	ASZ	05.03-06.06		0 281 002 461	0 986 284 007
TDI [1P1]	1,9	66/77	BKC; BLS <D3W>; BXE <D3W>; BXF <MF7>	07.05-12.10		0 281 002 531	0 986 284 009
TDI Syncro [1M1]	1,9	110	ARL				
			Fg.Nr. →1M..3..011 800	09.00-05.02		0 280 217 529	0 986 280 204
			Fg.Nr. 1M..3..011 801→	06.02-07.04		0 281 002 461	0 986 284 007
2.0 TDI [1P1]	2,0	100/103/125	AZV; BKD <D3X>; BMM <D7N>; BMN	07.05→		0 281 002 461	0 986 284 007
		103/125	CFHC <D91>; CFJA <D93>; CLCB <D91>	05.10→		0 281 002 956	
		125	CEGA <D93>	03.09→		0 281 002 735	
<b>Toledo</b>							
1.9 TDI [1M2]	1,9	66	ALH				
			PR-Nr. OGD	04.99-07.04	ØBD	0 281 002 757	
			PR-Nr. OGE		ØBD, WW	0 280 217 121	0 986 280 202
			PR-Nr. OGZ	04.99-07.04	ØBD	0 281 002 531	0 986 284 009
		66/81	AGR; AHF	04.99-09.02		0 281 002 757	
					WW	0 280 217 121	0 986 280 202
		81	ASV				
			PR-Nr. OGD	05.99-12.03	ØBD	0 281 002 757	
			PR-Nr. OGE		ØBD, WW	0 280 217 121	0 986 280 202
			PR-Nr. OGZ	05.99-12.03	ØBD	0 281 002 531	0 986 284 009
		96	ASZ	05.03-07.04		0 281 002 461	0 986 284 007
		110	ARL	09.00-05.02		0 280 217 529	0 986 280 204
TDI [5P2]	1,9	77	BJB; BKC; BLS; BXE	09.04→		0 281 002 531	0 986 284 009
2.0 TDI [5P2]	2,0	100/103/125	AZV; BKD; BMM; BMN	09.04-05.09		0 281 002 461	0 986 284 007

**SKODA**

<b>Fabia</b>							
1.4 TDI [6Y3]	1,4	51/55/59	AMF; BNM; BNV	05.03-12.07		0 281 002 531	0 986 284 009
1.9 TDI [6Y3]	1,9	74	ATD				
			Fg.Nr. →6Y..2..532 833 →6Y..2X040 209	09.99-04.02		0 281 002 757	
					WW	0 280 217 121	0 986 280 202
			Fg.Nr. 6Y..2..532 834 →6Y..2X040 210→	05.02-10.05		0 281 002 531	0 986 284 009
			AXR	10.05-12.07		0 281 002 531	0 986 284 009
<b>Fabia Combi</b>							
1.2 [5J5]	1,2	55	CFWA <D28>	03.10→		0 281 006 132	
1.4 TDI [5J5]	1,4	51/59	BMS <D4T>; BNM <D4S>; BNV <D4T>	10.07-03.10		0 281 002 531	0 986 284 009
TDI [6Y5]	1,4	51/55/59	AMF; BNM; BNV	05.03-12.07		0 281 002 531	0 986 284 009
1.9 TDI [5J5]	1,9	77	BLS <D3W>; BSW <D3W>	10.07-03.10		0 281 002 531	0 986 284 009
TDI [6Y5]	1,9	74	ATD				
			Fg.Nr. →6Y..2..532 833 →6Y..2X040 209	08.00-04.02		0 281 002 757	
					WW	0 280 217 121	0 986 280 202
			Fg.Nr. 6Y..2..532 834 →6Y..2X040 210→	05.02-10.05		0 281 002 531	0 986 284 009
			AXR	10.05-12.07		0 281 002 531	0 986 284 009
<b>Fabia Schrägheck</b>							
1.2 [5J2, 572]	1,2	55	CFWA <D28>	03.10→		0 281 006 132	
1.4 TDI [5J2, 572]	1,4	51/59	BMS <D4T>; BNM <D4S>; BNV <D4T>	01.07-03.10		0 281 002 531	0 986 284 009
TDI [6Y2]	1,4	51/55/59	AMF; BNM; BNV	05.03-04.07		0 281 002 531	0 986 284 009
1.9 TDI [5J2, 572]	1,9	77	BLS <D3W>; BSW <D3W>	04.07-03.10		0 281 002 531	0 986 284 009
TDI [6Y2]	1,9	74	ATD				
			Fg.Nr. →6Y..2..532 833 →6Y..2X040 209	09.99-04.02		0 281 002 757	
					WW	0 280 217 121	0 986 280 202
			Fg.Nr. 6Y..2..532 834 →6Y..2X040 210→	05.02-10.05		0 281 002 531	0 986 284 009
			AXR	10.05-04.07		0 281 002 531	0 986 284 009
TDI RS [6Y2]	1,9	96	ASZ	06.03-10.05		0 281 002 461	0 986 284 007
			BLT	10.05-04.07		0 281 002 461	0 986 284 007



<b>Octavia</b>						
1.6 TDI [1Z3]	1,6	77	CAYC <D38>		06.09→	0 281 002 956
1.9 TDI [1U2]	1,9	66/81	AGR; AHF			
			Fg.Nr. 1U..W..134 001→		08.98-12.09	0 281 002 757
			ALH; ASV			WW 0 280 217 121 0 986 280 202
			Fg.Nr. →1U..3..836 957 →1U..3A016 708		08.00-07.03	0 281 002 757
			→1U..38712 468			WW 0 280 217 121 0 986 280 202
			Fg.Nr. 1U..3..836 958→ 1U..3A016 709→		08.03-03.10	0 281 002 531 0 986 284 009
			1U..38712 469→			
		74	AXR		10.05-12.10	0 281 002 531 0 986 284 009
		96	ASZ		01.03-09.04	0 281 002 461 0 986 284 007
TDI, TDI 4x4 [1Z3]	1,9	77	BJB <D3W>; BKC <D3W>; BLS <D3W>; BXE <D3W>		05.04→	0 281 002 531 0 986 284 009
2.0 TDI RS [1Z3]	2,0	125	CEGA <D93>		05.08→	0 281 002 735
TDI, TDI RS [1Z3]	2,0	100/103/125	AZV <MS9>; BKD <D3W>; BMM <D7N>; BMN <DOM>		05.04-05.10	0 281 002 461 0 986 284 007
TDI, TDI 4x4 [1Z3]	2,0	81/103	CFHC <D91>; CFHF <D96>; CLCA <D96>; CLCB <D91>		02.10→	0 281 002 956
<b>Octavia Combi</b>						
1.6 TDI, TDI 4x4 [1Z5]	1,6	77	CAYC <D38>		06.09→	0 281 002 956
1.9 TDI [1U5]	1,9	66/81	ALH; ASV			
			Fg.Nr. →1U..3..836 957 →1U..3A016 708		08.00-07.03	0 281 002 757
			→1U..38712 468			WW 0 280 217 121 0 986 280 202
			Fg.Nr. 1U..3..836 958→ 1U..3A016 709→		08.03-03.10	0 281 002 531 0 986 284 009
			1U..38712 469→			
		74	AXR		10.05-12.10	0 281 002 531 0 986 284 009
		81	AHF			
			Fg.Nr. 1U..W..134 001→		08.98-01.06	0 281 002 757
						WW 0 280 217 121 0 986 280 202
		96	ASZ		01.03-09.04	0 281 002 461 0 986 284 007
TDI, TDI 4x4 [1U5]	1,9	66	AGR		05.98-12.09	0 281 002 757
						WW 0 280 217 121 0 986 280 202
		74	ATD			
			Fg.Nr. →1U..3..666 021 →1U..38665 263		08.00-04.02	0 281 002 757
						WW 0 280 217 121 0 986 280 202
			Fg.Nr. 1U..3..666 022→ 1U..38665 264→		05.02-01.06	0 281 002 531 0 986 284 009
TDI, TDI 4x4 [1Z5]	1,9	77	BJB <D3W>; BKC <D3W>; BLS <D3W>; BXE <D3W>		05.04→	0 281 002 531 0 986 284 009
2.0 TDI RS [1Z5]	2,0	125	CEGA <D93>		05.08→	0 281 002 735
TDI, TDI RS, TDI 4x4 [1Z5]	2,0	100/103/125	AZV <MS9>; BKD <D3W>; BMM <D7N>; BMN <DOM>		05.04-05.10	0 281 002 461 0 986 284 007
TDI, TDI 4x4 [1Z5]	2,0	81/103	CFHC <D91>; CFHF <D96>; CLCA <D96>; CLCB <D91>		02.10→	0 281 002 956
<b>Praktik</b>						
1.2 TDI [5J7]	1,2	55	CFWA <D28>		03.10→	0 281 006 132
1.4 TDI [5J7]	1,4	51/59	BMS; BNM; BNV		03.07→	0 281 002 531 0 986 284 009
1.6 TDI [5J7]	1,6	66	CAYB <D36>		03.10→	0 281 002 956
<b>Roomster</b>						
1.2 TDI [5J7]	1,2	55	CFWA <D28>		03.10→	0 281 006 132
1.4 TDI [5J7]	1,4	51/59	BMS <D4T>; BNM <D4S>; BNV <D4T>		05.06-03.10	0 281 002 531 0 986 284 009
1.6 [5J7]	1,6	66/77	CAYB <D36>; CAYC		03.10→	0 281 002 956
1.9 TDI [5J7]	1,9	74/77	AXR; BLS <D3W>; BSW <D3W>		03.06-03.10	0 281 002 531 0 986 284 009
<b>Superb</b>						
1.6 TDI [3T4]	1,6	77	CAYC <D38>		09.10→	0 281 002 956
1.9 TDI [3T4]	1,9	77	BLS <D3W>; BXE		03.08→	0 281 002 531 0 986 284 009
TDI [3U4]	1,9	74	AVB		02.02-10.05	0 281 002 463 0 986 284 008
		77/85/96	AVF; AWX; BPZ; BSV		12.01-03.08	0 281 002 461 0 986 284 007
2.0 TDI [3T4]	2,0	103	BKD; BMP <D7N>		03.08→	0 281 002 461 0 986 284 007
TDI [3U4]	2,0	91/103	BSS; BWW		10.05-03.08	0 281 002 461 0 986 284 007
TDI, TDI 4x4 [3T4]	2,0	103/125	CFFB <D91>; CFGB; CLJA		02.10→	0 281 002 956
		125	CBBB		06.08→	0 281 002 735
<b>Superb Combi</b>						
1.6 TDI [3T5]	1,6	77	CAYC <D38>		09.10→	0 281 002 956
1.9 TDI [3T5]	1,9	77	BLS; BXE		09.09→	0 281 002 531 0 986 284 009





◀ SKODA

<b>2.0 TDI [3T5]</b>	2,0	103	BKD; BMP	09.09→	<b>0 281 002 461</b>	<b>0 986 284 007</b>
TDI, TDI 4x4 [3T5]	2,0	103/125	CFFB <D91>; CFGB; CLJA <D91>	02.10→	<b>0 281 002 956</b>	
		125	CBBB	09.09→	<b>0 281 002 735</b>	
<b>Yeti</b>						
<b>1.6 TDI [5L7]</b>	1,6	77	CAYC <D38>	11.10→	<b>0 281 002 956</b>	
<b>2.0 TDI, TDI 4x4 [5L7]</b>	2,0	81/103/125	CFHA <D96>; CFHC <D91>; CFHF <D96>; CFJA <D93>; CLCA <D96>; CLCB <D91>	11.09→	<b>0 281 002 956</b>	
TDI 4x4 [5L7]	2,0	103/125	CBDB <D91>; CEGA <D93>	05.09-05.10	<b>0 281 002 735</b>	

**SSANGYONG**

<b>Rexton</b>						
<b>2.7 Xdi</b>	2,7	120-121	D27DT (OM665.925)	08.04→	<b>0 280 218 130</b>	
<b>Rodius</b>						
<b>2.7 Xdi 2WD, Xdi 4WD</b>	2,7	120-121	665.926 <D27DT>	05.05→	<b>0 280 218 130</b>	

**SUZUKI**

<b>Ignis Hatchback</b>						
<b>1.3 DDiS Turbo</b>	1,2	51	Z13DT	10.03-12.07	<b>0 281 002 619</b>	
<b>Swift Hatchback</b>						
<b>1.3 DDiS D Turbo [MZ/EZ]</b>	1,2	51-55	Z13DT Fg.Nr. →00500000	08.05→	<b>0 281 002 619</b>	
<b>SX4 Hatchback</b>						
<b>1.9 DDiS, DDiS 4WD</b>	1,9	88	D19AA	05.06→	<b>0 281 002 683</b>	
<b>2.0 DDiS, DDiS 4WD</b>	2,0	99	D20AA <DPF>	09.09→ THE	<b>0 281 002 860</b>	
<b>Wagon R+</b>						
<b>1.3 DDiS D Turbo [MM]</b>	1,3	51	Z13DT	09.03-03.06	<b>0 281 002 619</b>	









**UAZ**

<b>Patriot</b>						
<b>2.2 TD 4x4</b>	2,3	85	F1AE0481B	01.07→	<b>0 281 002 763</b>	

**VAUXHALL**

<b>Antara</b>						
<b>2.0 CDTI 4x4</b>	2,0	93/110	Z 20 DM <Ecotec>; Z 20 DMH <Ecotec>	11.06→	<b>0 281 002 683</b>	
<b>Astra</b>						
<b>1.3 CDTI [H]</b>	1,3	66	Z 13 DTH <Ecotec>	01.06-03.10	<b>0 281 002 683</b>	
<b>1.7 CDTI [H]</b>	1,7	59/74	Z 17 DTH <Turbo Ecotec>; Z 17 DTL <Turbo Ecotec>	03.04-03.07	<b>0 281 002 683</b>	
CDTI 16V [G]	1,7	59	Z 17 DTL <Turbo>	03.03-08.05	<b>0 281 002 549</b>	
DT, DTI [G]	1,7	50/55	X 17 DTL <Turbo>; Y 17 DT <Turbo (EE 4)>	03.98-08.05	<b>0 281 002 180</b>	
<b>1.9 CDTI [H]</b>	1,9	74/88/110	Z 19 DT <Turbo Ecotec>; Z 19 DTH <Turbo Ecotec>; Z 19 DTL <Turbo Ecotec>	03.04-03.10	<b>0 281 002 683</b>	
<b>2.0 DTI, DTL [G]</b>	2,0	60/74	X 20 DTL <Turbo>; Y 20 DTH <Turbo> Fg.Nr. →Y8999999 →YT999999 Mot.Nr. 12000001→1T000001→	03.98-08.05 03.98-08.05	<b>0 281 002 180</b> <b>0 281 002 428</b>	
DTL [G]	2,0	60	Y 20 DTL <Turbo> Mot.Nr. 12000001→1T000001→	09.00-08.05	<b>0 281 002 428</b>	
<b>Astra Estate</b>						
<b>1.3 CDTI [H]</b>	1,3	66	Z 13 DTH <Ecotec>	06.05-03.10	<b>0 281 002 683</b>	
<b>1.7 CDTI [G]</b>	1,7	59	Z 17 DTL <Turbo>	03.03-08.05	<b>0 281 002 549</b>	
CDTI [H]	1,7	59/74	Z 17 DTH <Turbo Ecotec>; Z 17 DTL <Turbo Ecotec>	08.04-03.07	<b>0 281 002 683</b>	
DT, DTI [G]	1,7	50/55	X 17 DTL <Turbo>; Y 17 DT <Turbo (EE 4)>	03.98-08.05	<b>0 281 002 180</b>	
<b>1.9 CDTI [H]</b>	1,9	74/88/110	Z 19 DT <Turbo Ecotec>; Z 19 DTH <Turbo Ecotec>; Z 19 DTL <Turbo Ecotec>	08.04-03.10	<b>0 281 002 683</b>	



									
<b>2.0 DTI, DTL [G]</b>	2,0	60/74	X 20 DTL <Turbo>; Y 20 DTH <Turbo>						
			Fg.Nr. →Y8999999 →YT999999		03.98-08.05			<b>0 281 002 180</b>	
			Mot.Nr. 12000001→1T000001→		03.98-08.05			<b>0 281 002 428</b>	
DTL [G]	2,0	60	Y 20 DTL <Turbo>						
			Mot.Nr. 12000001→1T000001→		09.00-08.05			<b>0 281 002 428</b>	
<b>Astra GTC</b>									
<b>1.7 [J]</b>	1,7	81/96	A 17 DTC <ecoFLEX>; A 17 DTS <ecoFLEX>		11.11→			<b>0 280 218 254</b>	
CDTI [H]	1,7	59/74	Z 17 DTH <Turbo Ecotec>; Z 17 DTL <Turbo Ecotec>		06.05-03.07			<b>0 281 002 683</b>	
<b>1.9 CDTI [H]</b>	1,9	88/110	Z 19 DTH <Turbo Ecotec>; Z 19 DTJ <Turbo Ecotec>		06.05-12.09			<b>0 281 002 683</b>	
<b>Astra Sports Tourer</b>									
<b>1.3 CDTI [J]</b>	1,2	70	A 13 DTE		09.10→			<b>0 281 002 940</b>	
<b>Astra TwinTop</b>									
<b>1.9 CDTI [H]</b>	1,9	110	Z 19 DTH <Ecotec>		09.05-12.09			<b>0 281 002 683</b>	
<b>Astra Van</b>									
<b>1.7 CDTI [G]</b>	1,7	59	Z 17 DTL <Turbo>		03.03-08.05			<b>0 281 002 549</b>	
DT [G]	1,7	50	X 17 DTL <Turbo>		03.98-08.00			<b>0 281 002 180</b>	
<b>2.0 DTI, DTL [G]</b>	2,0	60/74	X 20 DTL <Turbo>; Y 20 DTH <Turbo>						
			Fg.Nr. →Y8999999 →YT999999		03.98-08.05			<b>0 281 002 180</b>	
			Mot.Nr. 12000001→1T000001→		03.98-08.05			<b>0 281 002 428</b>	
<b>Combo</b>									
<b>1.3 CDTi [Tour]</b>	1,2	51	Z 13 DT <Turbo>		09.04→			<b>0 281 002 549</b>	
	1,3	51	Y 13 DT <Turbo>		09.04→			<b>0 281 002 549</b>	
		55	Z 13 DTJ <Turbo>		03.06→			<b>0 281 002 683</b>	
<b>1.7 CDTi [Tour]</b>	1,7	74	Z 17 DTH <Turbo>		09.04→			<b>0 281 002 549</b>	
DI, DTi [Tour]	1,7	48/55	Y 17 DT Turbo; Y 17 DTL Turbo		09.01-08.04			<b>0 281 002 180</b>	
<b>Corsa</b>									
<b>1.3 CDTI [C]</b>	1,2	51	Z 13 DT		09.03-09.06			<b>0 281 002 549</b>	
	1,3	51	Y 13 DT <Turbo Ecotec>		09.03-09.06			<b>0 281 002 549</b>	
		55	Z 13 DTJ <Turbo Ecotec>		09.05-09.06			<b>0 281 002 683</b>	
CDTI [D]	1,2	55/66	Z 13 DTH <Turbo Ecotec>; Z 13 DTJ <Turbo Ecotec>		07.06→			<b>0 281 002 683</b>	
		70	A 13 DTR <eco Flex>		01.11→			<b>0 281 002 940</b>	
	1,3	55/66	A 13 DTH <Turbo Ecotec>; A 13 DTJ <Turbo Ecotec>		10.06-02.09			<b>0 281 002 683</b>	
<b>1.7 CDTI [C]</b>	1,7	74	Z 17 DTH <Turbo Ecotec>		09.03-08.05			<b>0 281 002 549</b>	
DI, DTI [C]	1,7	48/55	Y 17 DT; Y 17 DTL		09.00-08.03			<b>0 281 002 180</b>	
<b>Frontera</b>									
<b>2.2 DTI [B]</b>	2,2	85/88	X 22 DTH <Turbo>; Y 22 DTH <Turbo>						
			Fg.Nr. →2V599999		09.98-09.04			<b>0 281 002 184</b>	
			Fg.Nr. 3V500001→		09.98-09.04			<b>0 281 002 479</b>	
<b>2.3 TD [A]</b>	2,3	74	23 DT <Turbo>		01.92-08.95			<b>0 281 002 144</b>	
<b>2.5 TDS Turbo [A]</b>	2,5	85	VM41B <Venturi-25TD>		06.96-08.98			<b>0 281 002 144</b>	
<b>Insignia</b>									
<b>2.0 CDTI, CDTI 4x4 [68]</b>	2,0	81/96/ 118/140	A 20 DT... <eco Flex>; A 20 DT... <Ecotec>; A 20 DTH <ecoFlex>; A 20 DTR <Ecotec>		11.08→			<b>0 281 002 912</b>	
CDTI, CDTI 4x4 [69]	2,0	81/96/ 118/140	A 20 DT... <eco Flex>; A 20 DT... <Ecotec>; A 20 DTH <ecoFlex>; A 20 DTR <Ecotec>		11.08→			<b>0 281 002 912</b>	
<b>Insignia Sports Tourer</b>									
<b>2.0 CDTI, CDTI 4x4 [35]</b>	2,0	81/96/ 118/140	A 20 DT... <eco Flex>; A 20 DT... <Ecotec>; A 20 DTH <ecoFlex>; A 20 DTR <Ecotec>		02.09→			<b>0 281 002 912</b>	
<b>Meriva</b>									
<b>1.3 CDTI [A]</b>	1,2	51	Y 13 DT <Ecotec>; Z 13 DT <Ecotec>		09.05-03.10			<b>0 281 002 620</b>	
	1,3	55	Z 13 DTJ <Ecotec>		09.03-03.10			<b>0 281 002 802</b>	
CDTI [B]	1,2	55/70	A 13 DTC <Ecotec>; A 13 DTE <ecoFlex>		06.10→			<b>0 281 002 940</b>	
<b>1.7 CDTI [A]</b>	1,7	74	Z 17 DTH <Turbo Ecotec (EE4)>		09.03-09.09			<b>0 281 002 620</b>	
CDTI [B]	1,7	74	A 17 DT <Ecotec>		04.10→			<b>0 281 002 940</b>	
DTI [A]	1,7	55	Y 17 DT <Turbo (EE4)>		03.03-09.05			<b>0 281 002 579</b>	
<b>Omega</b>									
<b>2.0 DTI [B]</b>	2,0	74	X 20 DTH Turbo		09.97-08.00			<b>0 281 002 180</b>	
<b>2.2 DTI [B]</b>	2,2	88	Y 22 DTH <Turbo>		06.00-09.03			<b>0 281 002 428</b>	
<b>2.5 TDI [B]</b>	2,5	110	Y 25 TD <Turbo>		09.01-09.04			<b>0 281 002 564</b>	
<b>Signum</b>									
<b>1.9 CDTI</b>	1,9	74/88/ 110	Z 19 DT <Ecotec>; Z 19 DTH <Ecotec>; Z 19 DTL <Ecotec>		04.04-09.08			<b>0 281 002 683</b>	
<b>2.0 DTI</b>	2,0	74	Y 20 DTH <Ecotec>		05.03-09.05			<b>0 281 002 479</b>	





◀ VAUXHALL

2.2 DTI	2,2	86-92	Y 22 DTR <Ecotec>	05.03-09.08	0 281 002 479
3.0 CDTI	3,0	130-135	Y 30 DT <Ecotec>	05.03-09.05	0 281 002 605
			Z 30 DT <Ecotec>	09.05-09.08	0 281 002 773
<b>Sintra</b>					
2.2 TD	2,2	85	X 22 DTH <Turbo>	09.97-09.99	0 281 002 184
<b>Tigra TwinTop</b>					
1.3 CDTI [B]	1,3	51	Z 13 DT <Turbo Ecotec>	06.04-03.09	0 281 002 549
<b>Vectra</b>					
1.9 CDTI [C]	1,9	74/88/ 110	Z 19 DT <Ecotec>; Z 19 DTH <Ecotec>; Z 19 DTL <Ecotec>	04.04-10.08	0 281 002 683
2.0 DI [B]	2,0	60	X 20 DTL <Ecotec 16V Turbo>		
			Fg.Nr. W1000001→ Fg.Nr. →V7999999	09.96-08.00	0 281 002 180 0 281 002 139
DTI [B]	2,0	74	X 20 DTH <16V Turbo> Y 20 DTH <16V Turbo>	09.97-08.00 09.00-08.01	0 281 002 180 0 281 002 428
DTI [C]	2,0	74	Y 20 DTH <Turbo Ecotec>	04.02-09.05	0 281 002 479
2.2 DTI [B]	2,2	92	Y 22 DTR <Turbo>	09.00-08.01	0 281 002 428
DTI [C]	2,2	86-92	Y 22 DTR <Turbo Ecotec>	04.02-09.05	0 281 002 479
3.0 CDTI [C]	3,0	130-135	Y 30 DT <Ecotec>	03.03-10.08	0 281 002 605
			Z 30 DT <Ecotec>	09.05-10.08	0 281 002 773
<b>Vectra Estate</b>					
1.9 CDTI [C]	1,9	74/88/ 110	Z 19 DT <Ecotec>; Z 19 DTH <Ecotec>; Z 19 DTL <Ecotec>	04.04-10.08	0 281 002 683
2.0 DI [B]	2,0	60	X 20 DTL <Ecotec 16V Turbo>		
			Fg.Nr. W1000001→ Fg.Nr. →V7999999	09.96-08.00	0 281 002 180 0 281 002 139
DTI [B]	2,0	74	X 20 DTH <16V Turbo> Y 20 DTH <16V Turbo>	09.97-08.00 09.00-08.01	0 281 002 180 0 281 002 428
DTI [C]	2,0	74	Y 20 DTH <Turbo Ecotec>	09.03-09.05	0 281 002 479
2.2 DTI [B]	2,2	92	Y 22 DTR <Turbo>	09.00-08.01	0 281 002 428
DTI [C]	2,2	86-92	Y 22 DTR <Ecotec>	09.03-09.05	0 281 002 479
3.0 CDTI [C]	3,0	130-135	Y 30 DT <Ecotec>	09.03-10.08	0 281 002 605
			Z 30 DT <Ecotec>	09.05-10.08	0 281 002 773
<b>Zafira</b>					
2.0 DI [A]	2,0	60	X 20 DTL <Turbo Ecotec>		
			Fg.Nr. →Y8999999 →YT999999 Mot.Nr. 12000001→1T000001→	03.99-08.00	0 281 002 180 0 281 002 428
DTI [A]	2,0	74	Y 20 DTH <Turbo Ecotec>		
			Fg.Nr. →Y2999999 →Y5999999 →Y6999999 →Y8999999 →YH999999	04.99-06.05	0 281 002 180
			Fg.Nr. 12000001→22999999 15000001→25999999 16000001→26999999 18000001→28999999 1H000001→2H999999	04.99-06.05	0 281 002 428
			Fg.Nr. 32000001→35000001→36000001→ 38000001→3H000001→3H000001→	04.99-06.05	0 281 002 478



**VOLVO**

<b>C30</b>					
2.0 D3, D4	2,0	110/130	D5204T; D5204T5	08.10→	0 281 002 972
2.4 D5	2,4	120/132	D5244T8...; D5244T9	10.06-07.10	0 281 002 730
<b>C70 II Cabrio</b>					
2.0 D3, D4	2,0	110/130	D5204T; D5204T5	10.10→	0 281 002 972
2.4 D, D5	2,4	120/132	D5244T8...; D5244T9	08.06-07.10	0 281 002 730
<b>S40 II</b>					
2.0 D3, D4	2,0	110/130	D5204T; D5204T5	08.10→	0 281 002 972
2.4 D5	2,4	120/132	D5244T8...; D5244T9		
			Fg.Nr. →533875 Fg.Nr. 533876→	03.06-07.10	0 281 002 730 0 281 006 184

									
<b>S60 I</b>									
2.4 D	2,4	96/120	D5244T; D5244T2			08.01-07.06			<b>0 280 218 088</b>
D, D5	2,4	93/120/136	D5244T4; D5244T5; D5244T7			08.05-07.09			<b>0 281 002 730</b>
<b>S60 II</b>									
2.0 D3	2,0	120	D5204T2; D5204T3			08.10→			<b>0 281 002 972</b>
2.4 D5, D5 AWD	2,4	151/158	D5244T10; D5244T11; D5244T15			08.10→			<b>0 281 002 972</b>
<b>S70</b>									
2.5 TDI	2,5	103	D5252 T						
			Fg.Nr. →596595			01.97-07.00			<b>0 281 002 155</b>
			Fg.Nr. 596596→			01.97-07.00			<b>0 280 218 108</b>
<b>S80 I</b>									
2.4 D, D5	2,4	96/120	D5244T; D5244T2			08.01-07.06			<b>0 280 218 088</b>
2.5 TDI	2,5	103	D5252T			08.98-07.01			<b>0 280 218 108</b>
<b>S80 II</b>									
2.0 D3	2,0	120	D5204T2; D5204T3			08.10→			<b>0 281 002 972</b>
2.4 D, D5, D5 AWD	2,4	120/129/151/158	D5244T10; D5244T11; D5244T14; D5244T15; D5244T19			11.08→			<b>0 281 002 972</b>
		120/136	D5244T4; D5244T5			03.06-07.09			<b>0 281 002 730</b>
<b>V50</b>									
2.0 D3, D4	2,0	110/130	D5204T; D5204T5			08.10→			<b>0 281 002 972</b>
2.4 D5	2,4	120/132	D5244T8...; D5244T9						
			Fg.Nr. →599018			04.06-07.10			<b>0 281 002 730</b>
			Fg.Nr. 599019→			04.06-07.10			<b>0 281 006 184</b>
<b>V60</b>									
2.0 D3	2,0	120	D5204T2			09.10→			<b>0 281 002 972</b>
2.4 D5, D5 AWD	2,4	151	D5244T10			09.10-07.11			<b>0 281 002 972</b>
<b>V70 I</b>									
2.5 TDI	2,5	103	D5252T						
			Fg.Nr. →587536			01.97-03.00			<b>0 281 002 155</b>
			Fg.Nr. 587537→			01.97-03.00			<b>0 280 218 108</b>
<b>V70 II</b>									
2.4 D, D AWD, D5, D5 AWD	2,4	96/120/136	D5244T; D5244T2; D5244T3			08.01-07.06			<b>0 280 218 088</b>
D, D5, D5 AWD	2,4	90/93/120/136	D5244T4; D5244T5; D5244T6; D5244T7			08.06-07.07			<b>0 281 002 730</b>
2.5 D	2,5	103	D5252T			03.00-07.01			<b>0 280 218 108</b>
<b>V70 III</b>									
2.0 D3	2,0	120	D5204T2; D5204T3			08.10→			<b>0 281 002 972</b>
2.4 D, D5, D5 AWD	2,4	120/136	D5244T4; D5244T5			08.07-07.09			<b>0 281 002 730</b>
		129/151/158	D5244T10; D5244T11; D5244T14; D5244T15			08.09→			<b>0 281 002 972</b>
<b>XC60</b>									
2.0 D3 DRIVE	2,0	120	D5204T2						
			Fg.Nr. →50098			08.10-07.11			<b>0 281 002 730</b>
			Fg.Nr. 50099→			08.10-07.11			<b>0 281 002 972</b>
			D5204T3			08.11→			<b>0 281 002 972</b>
2.4 D AWD, D DRIVE, D5 AWD	2,4	120/129/136/151	D5244T4; D5244T5; D5244T10; D5244T14; D5244T16						
			Fg.Nr. →50098			03.09-07.11			<b>0 281 002 730</b>
			Fg.Nr. 50099→			03.09-07.11			<b>0 281 002 972</b>
D3 AWD	2,4	120	D5244T17			08.11→			<b>0 281 002 972</b>
D5 AWD	2,4	158	D 5244...			08.11→			<b>0 281 002 972</b>
<b>XC70 I</b>									
2.4 D	2,4	120	D5244T			08.02-07.06			<b>0 280 218 088</b>
D5	2,4	136	D5244T4			12.05-07.07			<b>0 281 002 730</b>
<b>XC70 II</b>									
2.0 D3 Drive	2,0	120	D5204T2; D5204T3			08.10→			<b>0 281 002 972</b>
2.4 D AWD, D DRIVE, D3 AWD, D5 AWD	2,4	120/129/151/158	D5244T10; D5244T11; D5244T14; D5244T15; D5244T16; D5244T17			08.09→			<b>0 281 002 972</b>
D AWD, D5 AWD	2,4	120/136	D5244T4; D5244T5			08.07-07.09			<b>0 281 002 730</b>





◀ VOLVO

XC90					
2.4 D3 FWD, D5 AWD	2,4	120/136	D5244T4; D5244T5 Fg.Nr. →574466	05.05→	<b>0 281 002 730</b>
			Fg.Nr. 574467→	05.05→	<b>0 281 006 184</b>
D5 AWD	2,4	120	D5244T	01.03-07.06	<b>0 280 218 088</b>
		147	D5244T18	08.10→	<b>0 281 006 184</b>
850					
TDI	2,5	103	D5252T	05.96-07.97	<b>0 281 002 155</b>
850 Kombi					
TDI	2,5	103	D5252T	05.96-07.97	<b>0 281 002 155</b>

**VW (VOLKSWAGEN)**

Amarok					
2.0 BiTDI, BiTDI 4Motion, TDI, TDI 4Motion [2H]	2,0	90/120	CDBA <D45>; CDCA <D46>	09.10→	<b>0 281 002 956</b>
Bora					
1.9 TDI [1J2]	1,9	74	AXR Fg.Nr. →1J..2..380 000 →1J..2D420 000	05.01-10.01	<b>0 281 002 757</b>
			Fg.Nr. 1J..2..380 001→1J..2D420 000→	11.01-05.05	<b>0 281 002 531 0 986 284 009</b>
		81	ASV	05.00-05.05	<b>0 281 002 757</b>
				WW	<b>0 280 217 121 0 986 280 202</b>
TDI [9M2]	1,9	74	BEW	01.05-09.05	<b>0 281 002 531 0 986 284 009</b>
TDI, TDI 4 Motion [1J2]	1,9	66/81/85	AGR; AHF; AJM; ALH	09.98-05.05	<b>0 281 002 757</b>
				WW	<b>0 280 217 121 0 986 280 202</b>
		74	ATD Fg.Nr. →1J..2..380 000 →1J..2D420 000	01.00-10.01	<b>0 281 002 757</b>
			Fg.Nr. 1J..2..380 001→1J..2D420 000→	11.01-05.05	<b>0 281 002 531 0 986 284 009</b>
		85	AUY	01.00-04.01	<b>0 281 002 757</b>
				WW	<b>0 280 217 121 0 986 280 202</b>
		96	ASZ Fg.Nr. →1J..2..600 000	01.01-04.02	<b>0 280 217 529 0 986 280 204</b>
			Fg.Nr. 1J..2..600 001→	05.02-05.05	<b>0 281 002 461 0 986 284 007</b>
		110	ARL Fg.Nr. →1J..2..600 000	01.00-04.02	<b>0 280 217 529 0 986 280 204</b>
			Fg.Nr. 1J..2..600 001→	05.02-05.05	<b>0 281 002 461 0 986 284 007</b>
Bora Variant					
1.9 TDI [1J6]	1,9	74	AXR Fg.Nr. →1J..2..380 000 →1J..2D420 000	05.01-10.01	<b>0 281 002 757</b>
			Fg.Nr. 1J..2..380 001→1J..2D420 000→	11.01-05.05	<b>0 281 002 531 0 986 284 009</b>
		81	ASV	05.00-05.05	<b>0 281 002 757</b>
				WW	<b>0 280 217 121 0 986 280 202</b>
TDI, TDI 4 Motion [1J6]	1,9	66/81/85	AGR; AHF; AJM	09.98-05.05	<b>0 281 002 757</b>
				WW	<b>0 280 217 121 0 986 280 202</b>
		74	ATD Fg.Nr. →1J..2..380 000 →1J..2D420 000	05.00-10.01	<b>0 281 002 757</b>
			Fg.Nr. 1J..2..380 001→1J..2D420 000→	11.01-05.05	<b>0 281 002 531 0 986 284 009</b>
		85	AUY	01.00-04.01	<b>0 281 002 757</b>
				WW	<b>0 280 217 121 0 986 280 202</b>
		96	ASZ Fg.Nr. →1J..2..600 000	01.01-04.02	<b>0 280 217 529 0 986 280 204</b>
			Fg.Nr. 1J..2..600 001→	05.02-05.05	<b>0 281 002 461 0 986 284 007</b>
		110	ARL Fg.Nr. →1J..2..600 000	05.02-05.05	<b>0 281 002 461 0 986 284 007</b>







<b>Caddy</b>							
1.9 TDI [9K9]	1,9	66	ALH		09.00-06.03		<b>0 281 002 216 0 986 284 001</b>
TDI, TDI 4 Motion [2K]	1,9	55/77	BJB <D3W>; BLS <D3W>; BSU <D4U>		02.04-08.10		<b>0 281 002 531 0 986 284 009</b>
2.0 SDI [2K]	2,0	51	BST <DOK>		06.05-08.10		<b>0 281 002 531 0 986 284 009</b>
TDI [2K]	2,0	103	BMM <D7N>		09.07-08.10		<b>0 281 002 461 0 986 284 007</b>
TDI, TDI 4 Motion [2C]	2,0	81/103	CFHC <D91>; CFHE; CFHF; CLCA <D96>		08.10→		<b>0 281 002 956</b>
<b>Eos</b>							
2.0 TDI [1F7]	2,0	103	BMM		05.06-05.08		<b>0 281 002 461 0 986 284 007</b>
			CBAB <D91>		05.08-11.10		<b>0 281 002 735</b>
TDI [1F8]	2,0	100/103	CFFA <D94>; CFFB <D91>		11.10→		<b>0 281 002 956</b>
<b>Fox</b>							
1.4 TDI [5Z1]	1,4	51	BNM <D4S>		04.05→		<b>0 281 002 531 0 986 284 009</b>
<b>Golf IV</b>							
1.9 TDI [MY08]	1,9	66	AGR		04.07→		<b>0 281 002 757</b>
						WW	<b>0 280 217 121 0 986 280 202</b>
TDI [1J1]	1,9	74	AXR				
			Fg.Nr. →1J..2B088 000 →1J..2D420 000 →1J..2P055 000 →1J..2U030 000 →1J..2W350 000		05.01-11.01		<b>0 281 002 757</b>
						WW	<b>0 280 217 121 0 986 280 202</b>
			Fg.Nr. 1J..2B088 001 → 1J..2D420 001 → 1J..2P055 001 → 1J..2U030 001 → 1J..2W350 001 →		12.01-05.04		<b>0 281 002 531 0 986 284 009</b>
		81	AHF		05.00-12.05		<b>0 281 002 757</b>
						WW	<b>0 280 217 121 0 986 280 202</b>
			Fg.Nr. 1J..XB045 001 → 1J..XD092 001 → 1J..XP073 001 → 1J..XW181 001 →		08.98-05.04		<b>0 281 002 757</b>
						WW	<b>0 280 217 121 0 986 280 202</b>
			ASV		05.00-05.04		<b>0 281 002 757</b>
						WW	<b>0 280 217 121 0 986 280 202</b>
TDI [9B1]	1,9	66	AGR; ALH		07.01-03.07		<b>0 281 002 757</b>
						WW	<b>0 280 217 121 0 986 280 202</b>
TDI, TDI 4 Motion [1J1]	1,9	66	AGR				
			Fg.Nr. 1J..XB045 001 → 1J..XD092 001 → 1J..XP073 001 → 1J..XW181 001 →		08.98-09.02		<b>0 281 002 757</b>
						WW	<b>0 280 217 121 0 986 280 202</b>
		66/85	AJM; ALH		10.97-05.04		<b>0 281 002 757</b>
						WW	<b>0 280 217 121 0 986 280 202</b>
		74	ATD				
			Fg.Nr. →1J..2B088 000 →1J..2D420 000 →1J..2P055 000 →1J..2U030 000 →1J..2W350 000		02.00-11.01		<b>0 281 002 757</b>
						WW	<b>0 280 217 121 0 986 280 202</b>
			Fg.Nr. 1J..2B088 001 → 1J..2D420 001 → 1J..2P055 001 → 1J..2U030 001 → 1J..2W350 001 →		12.01-06.05		<b>0 281 002 531 0 986 284 009</b>
		85	AUY		01.00-07.01		<b>0 281 002 757</b>
						WW	<b>0 280 217 121 0 986 280 202</b>
		96	ASZ				
			Fg.Nr. →1J..2..600 000		04.01-04.02		<b>0 280 217 529 0 986 280 204</b>
			Fg.Nr. 1J..2..600 001 →		05.02-06.05		<b>0 281 002 461 0 986 284 007</b>
		110	ARL				
			Fg.Nr. →1J..2..600 000		09.00-04.02		<b>0 280 217 529 0 986 280 204</b>
			Fg.Nr. 1J..2..600 001 →		05.02-06.05		<b>0 281 002 461 0 986 284 007</b>
<b>Golf IV Variant</b>							
1.9 TDI [1J5]	1,9	74	AXR				
			Fg.Nr. →1J..2B088 000 →1J..2D420 000 →1J..2P055 000 →1J..2U030 000 →1J..2W350 000		05.01-11.01		<b>0 281 002 757</b>
						WW	<b>0 280 217 121 0 986 280 202</b>
			Fg.Nr. 1J..2B088 001 → 1J..2D420 001 → 1J..2P055 001 → 1J..2U030 001 → 1J..2W350 001 →		12.01-06.06		<b>0 281 002 531 0 986 284 009</b>
TDI, TDI 4 Motion [1J5]	1,9	66/81/ 85	AGR; AHF; AJM; ALH; ASV		05.99-06.06		<b>0 281 002 757</b>
						WW	<b>0 280 217 121 0 986 280 202</b>





◀ VW

<b>1.9</b>	TDI, TDI 4 Motion [1J5]	1,9	74	ATD				
					Fg.Nr. →1J..2B088 000 →1J..2D420 000	01.00-11.01	<b>0 281 002 757</b>	
					→1J..2P055 000 →1J..2U030 000	02.00-11.01	<b>0 280 217 121</b>	<b>0 986 280 202</b>
					→1J..2W350 000			
					Fg.Nr. 1J..2B088 001→ 1J..2D420 001→	12.01-06.06	<b>0 281 002 531</b>	<b>0 986 284 009</b>
					1J..2P055 001→ 1J..2U030 001→			
					1J..2W350 001→			
			85	AUY		11.99-07.01	<b>0 281 002 757</b>	
						WW	<b>0 280 217 121</b>	<b>0 986 280 202</b>
			96	ASZ				
					Fg.Nr. →1J..2..600 000	04.01-04.02	<b>0 280 217 529</b>	<b>0 986 280 204</b>
					Fg.Nr. 1J..2..600 001→	05.02-06.06	<b>0 281 002 461</b>	<b>0 986 284 007</b>
<b>Golf Plus</b>								
<b>1.9</b>	TDI [5M1]	1,9	66/77	BKC; BLS; BRU; BXE; BXF; BXJ		01.05-01.09	<b>0 281 002 531</b>	<b>0 986 284 009</b>
<b>2.0</b>	TDI [5M1]	2,0	96/100/103	AZV; BEE; BKD; BMM		01.05-05.09	<b>0 281 002 461</b>	<b>0 986 284 007</b>
	TDI [521]	2,0	81/100/103	CBDA <D94>; CBDB <D91>; CBDC <D96>		01.09-05.10	<b>0 281 002 735</b>	
				CFHB <D94>; CFHC <D91>; CLCA <D96>		11.09→	<b>0 281 002 956</b>	
<b>Golf V</b>								
<b>1.9</b>	TDI, TDI 4 Motion [1K1]	1,9	66/77	BKC; BLS; BRU; BXE; BXF		10.03-11.08	<b>0 281 002 531</b>	<b>0 986 284 009</b>
<b>2.0</b>	SDI [1K1]	2,0	55	BDK		01.04-11.08	<b>0 281 002 531</b>	<b>0 986 284 009</b>
	TDI [1K1]	2,0	100	AZV		10.03-11.08	<b>0 281 002 461</b>	<b>0 986 284 007</b>
	TDI, TDI 4 Motion [1K1]	2,0	103/125	BKD; BMM; BMN		10.03-11.08	<b>0 281 002 461</b>	<b>0 986 284 007</b>
<b>Golf V Variant</b>								
<b>1.9</b>	TDI, TDI 4 Motion [1K5]	1,9	77	BLS; BXE		05.07-06.09	<b>0 281 002 531</b>	<b>0 986 284 009</b>
<b>2.0</b>	TDI [1K5]	2,0	100/103	CBDA; CBDB		07.08-07.09	<b>0 281 002 735</b>	
	TDI, TDI 4 Motion [1K5]	2,0	100/103	AZV; BKD; BMM		05.07-06.09	<b>0 281 002 461</b>	<b>0 986 284 007</b>
<b>Golf VI</b>								
<b>2.0</b>	TDI [5K1]	2,0	81/103	CLCA <D96>		05.10→	<b>0 281 002 956</b>	
				CJAA <D91>		09.09→	<b>0 281 002 735</b>	
	TDI, TDI 4 Motion [5K1]	2,0	81/100/103/125	CBAA <D94>; CBAB <D91>; CBBB <D93>; CBDC <D96>		10.08-05.10	<b>0 281 002 735</b>	
				100/103/125	CFFA <D94>; CFFB <D91>; CFGB <D93>	11.09→	<b>0 281 002 956</b>	
<b>Golf VI Cabrio</b>								
<b>2.0</b>	TDI [517]	2,0	103	CFHC <D91>		11.11→	<b>0 281 002 956</b>	
<b>Golf VI Variant</b>								
<b>2.0</b>	TDI [AJ5]	2,0	81/100/103	CFHB <D94>; CFHC <D91>; CLCA <D96>		07.09→	<b>0 281 002 956</b>	
				100/103	CBDA <D91>; CBDB <D91>	07.09→	<b>0 281 002 735</b>	
				103	BMM <D7N>	07.09→	<b>0 281 002 461</b>	<b>0 986 284 007</b>
<b>Jetta</b>								
<b>1.9</b>	TDI [1K2]	1,9	74/77	BKC; BLS <D3W>; BRM; BXE <D3W>		01.05→	<b>0 281 002 531</b>	<b>0 986 284 009</b>
	TDI [9M2]	1,9	74	BEW		07.03→	<b>0 281 002 531</b>	<b>0 986 284 009</b>
<b>2.0</b>	TDI [1K2]	2,0	81/100/103	CLCA <D96>		01.10-10.10	<b>0 281 002 956</b>	
				AZV; BKD; BMM; BMN		08.05-06.08	<b>0 281 002 461</b>	<b>0 986 284 007</b>
				125	CBDA <D94>; CBDB <D91>; CEGA <D93>	07.08-10.10	<b>0 281 002 735</b>	
	TDI [162]	2,0	103	CFFB <D91>; CLCB <D91>		10.10→	<b>0 281 002 956</b>	
<b>Jetta SportWagen</b>								
<b>2.0</b>	TDI [1K5]	2,0	103	CBEA		04.08→	<b>0 281 002 735</b>	
<b>Jetta V</b>								
<b>1.9</b>	TDI [1K6]	1,9	77	BKC		03.06→	<b>0 281 002 531</b>	<b>0 986 284 009</b>
<b>2.0</b>	TDI [1K6]	2,0	103	BKD		03.06→	<b>0 281 002 461</b>	<b>0 986 284 007</b>
<b>Lupo</b>								
<b>1.2</b>	TDI 3L [6X1]	1,2	45	ANY; AYZ		10.98-07.05	<b>0 280 218 002</b>	<b>0 986 280 205</b>
<b>1.4</b>	TDI [6X1]	1,4	55	AMF		06.98-07.05	<b>0 281 002 318</b>	<b>0 986 284 002</b>
<b>New Beetle</b>								
<b>1.9</b>	TDI [1C1/9C1]	1,9	66/74/77	ALH		01.98-06.04	<b>0 281 002 757</b>	
				ATD; BEW; BSW <D3W>		10.00→	<b>0 281 002 531</b>	<b>0 986 284 009</b>
<b>New Beetle Cabriolet</b>								
<b>1.9</b>	TDI [1Y7]	1,9	74/77	AXR; BSW <D3W>		06.03-09.10	<b>0 281 002 531</b>	<b>0 986 284 009</b>



<b>Passat</b>							
1.9 TDI [3B2]	1,9	66	AHH AHU		08.97-11.00	0 281 002 216	0 986 284 001
			Fg.Nr. WE118001/WP100001→		09.97-11.00	0 281 002 216	0 986 284 001
		81	AFN				
			Fg.Nr. WE118001/WP100001→		09.97-11.00	0 281 002 216	0 986 284 001
TDI [3B3]	1,9	74	AVB				
			Fg.Nr. →3B..2P241 613 →3B..2P240 805 →3B..2E262 022		10.00-10.01	0 281 002 216	0 986 284 001
			Fg.Nr. 3B..2P241 614→ 3B..2P240 806→ 3B..2E262 023→		11.01-05.05	0 281 002 463	0 986 284 008
TDI [3C2]	1,9	77	BKC; BLS; BXE		03.05-11.08	0 281 002 531	0 986 284 009
TDI syncro [3B2]	1,9	81	AFN				
			Fg.Nr. WE 106 001→ WP 090 001→		08.97-11.00	0 281 002 216	0 986 284 001
TDI, TDI syncro [3B2]	1,9	74/81/85	AJM; ATJ; AVB; AVG		01.98-11.00	0 281 002 216	0 986 284 001
TDI, TDI 4 Motion [3B3]	1,9	96	AVF; AWX				
			Fg.Nr. →3B..1..400 000		10.00-04.01	0 280 217 529	0 986 280 204
			Fg.Nr. 3B..2..000 001→		05.01-05.05	0 281 002 461	0 986 284 007
2.0 TDI [3B3]	2,0	100	BGW		11.03-05.05	0 281 002 461	0 986 284 007
TDI, TDI 4 Motion [3C2]	2,0	81/100/ 103/105/ 125	CBAA <D94>; CBAB <D91>; CBAC <D92>; CBBB <D93>; CBDC <D96>		05.08-11.10	0 281 002 735	
		88/90/ 100/103/ 120/125	BKP; BMA; BMP; BMR; BUZ; BVE; BWV		03.05-06.08	0 281 002 461	0 986 284 007
TDI, TDI 4 Motion [362]	2,0	100/103/ 125	CFFA <D94>; CFFB <D91>; CFGB <D93>; CLLA		08.10→	0 281 002 956	
2.5 TDI [3B2]	2,5	110	AKN		08.98-11.00	0 281 002 224	
TDI syncro [3B2]	2,5	110	AKN				
			Fg.Nr. →3B..Y..200 000		08.98-11.99	0 281 002 224	
			Fg.Nr. 3B..Y..200 001→		12.99-11.00	0 281 002 403	0 986 284 004
TDI, TDI syncro [3B2]	2,5	110	AFB		08.98-11.00	0 281 002 224	
<b>Passat CC</b>							
2.0 TDI, TDI 4 Motion [357]	2,0	100/103/ 105/125	CBAA <D94>; CBAB <D91>; CBAC; CBBB <D93>		05.08-11.10	0 281 002 735	
		100/103/ 125	CFFA <D94>; CFFB <D91>; CFGB <D93>		11.10→	0 281 002 956	
<b>Passat Variant</b>							
1.9 TDI [3B5]	1,9	66	AHH AHU		05.98-11.00	0 281 002 216	0 986 284 001
			Fg.Nr. WE118001/WP100001→		09.97-11.00	0 281 002 216	0 986 284 001
		81	AFN				
			Fg.Nr. WE118001/WP100001→		09.97-11.00	0 281 002 216	0 986 284 001
TDI [3B6]	1,9	74	AVB				
			Fg.Nr. →3B..2P241 613 →3B..2P240 805 →3B..2E262 022		10.00-10.01	0 281 002 216	0 986 284 001
			Fg.Nr. 3B..2P241 614→ 3B..2P240 806→ 3B..2E262 023→		11.01-05.05	0 281 002 463	0 986 284 008
TDI [3C5]	1,9	77	BKC; BLS; BXE		08.05-11.08	0 281 002 531	0 986 284 009
TDI syncro [3B5]	1,9	81	AFN				
			Fg.Nr. WE 106 001→ WP 090 001→		08.97-11.00	0 281 002 216	0 986 284 001
TDI, TDI syncro [3B5]	1,9	74/81/85	AJM; ATJ; AVB; AVG		03.99-11.00	0 281 002 216	0 986 284 001
TDI, TDI 4 Motion [3B6]	1,9	96	AVF; AWX				
			Fg.Nr. →3B..1..400 000		10.00-04.01	0 280 217 529	0 986 280 204
			Fg.Nr. 3B..2..000 001→		05.01-05.05	0 281 002 461	0 986 284 007
2.0 TDI [3B6]	2,0	100	BGW		11.03-05.05	0 281 002 461	0 986 284 007
TDI, TDI 4 Motion [3C5]	2,0	81/100/ 103/105/ 125	CBAA <D94>; CBAB <D91>; CBAC <D92>; CBBB <D93>; CBDC <D96>		01.08-11.10	0 281 002 735	
		88/90/ 100/103/ 120/125	BKP; BMA; BMP; BMR; BUZ; BVE; BWV		08.05-06.08	0 281 002 461	0 986 284 007





◀ VW

<b>2.0</b>	TDI, TDI 4 Motion [365]	2,0	100/103/125	CFFA <D94>; CFFB <D91>; CFGB <D93>; CLLA	08.10→	<b>0 281 002 956</b>	
<b>2.5</b>	TDI [3B5]	2,5	110	AKN	05.99-11.00	<b>0 281 002 224</b>	
	TDI syncro [3B5]	2,5	110	AKN			
				Fg.Nr. →3B..Y..200 000	05.99-11.99	<b>0 281 002 224</b>	
				Fg.Nr. 3B..Y..200 001→	12.99-11.00	<b>0 281 002 403</b>	<b>0 986 284 004</b>
	TDI, TDI syncro [3B5]	2,5	110	AFB	08.98-11.00	<b>0 281 002 224</b>	
<b>Phaeton</b>							
<b>5.0</b>	TDI 4 Motion [3D]	5,0	230	AJS	11.02-10.06	<b>0 281 002 461</b>	<b>0 986 284 007</b>
<b>Polo</b>							
<b>1.2</b>	TDI [6R1]	1,2	55	CFWA <D28>	10.09→	<b>0 281 006 132</b>	
<b>1.4</b>	TDI [6N2]	1,4	55	AMF	10.99-09.01	<b>0 281 002 318</b>	<b>0 986 284 002</b>
	TDI [9N1]	1,4	55	AMF; BAY			
				Fg.Nr. →9N..2..120 000	09.01-04.02	<b>0 281 002 757</b>	
					WW	<b>0 280 217 121</b>	<b>0 986 280 202</b>
				Fg.Nr. 9N..3..000 001→	05.02-05.05	<b>0 281 002 531</b>	<b>0 986 284 009</b>
	TDI [9N2]	1,4	55	BAY	07.03-05.07	<b>0 281 002 531</b>	<b>0 986 284 009</b>
	TDI [9N3]	1,4	51/58/59	BMS; BNM; BNV; BWB	04.05-12.09	<b>0 281 002 531</b>	<b>0 986 284 009</b>
	TDI [9N4]	1,4	58	BNV	04.05→	<b>0 281 002 531</b>	<b>0 986 284 009</b>
	TDI [9V4]	1,4	55	AMF	10.02-12.03	<b>0 281 002 757</b>	
<b>1.6</b>	TDI [6R1]	1,6	77	CLNA	02.10→	<b>0 281 002 956</b>	
<b>1.9</b>	TDI [9N1]	1,9	74	ATD; AXR			
				Fg.Nr. →9N..2..120 000	09.01-04.02	<b>0 281 002 757</b>	
					WW	<b>0 280 217 121</b>	<b>0 986 280 202</b>
				Fg.Nr. 9N..3..000 001→	05.02-05.05	<b>0 281 002 531</b>	<b>0 986 284 009</b>
		96	ASZ		11.03-05.05	<b>0 281 002 461</b>	<b>0 986 284 007</b>
			BLT		05.04-05.05	<b>0 281 002 461</b>	<b>0 986 284 007</b>
	TDI [9N3]	1,9	74	ATD; AXR	04.05-12.09	<b>0 281 002 531</b>	<b>0 986 284 009</b>
				BMT	05.06-12.09	<b>0 281 002 531</b>	<b>0 986 284 009</b>
		96	ASZ		04.05-12.09	<b>0 281 002 461</b>	<b>0 986 284 007</b>
			BLT		04.05-12.09	<b>0 281 002 461</b>	<b>0 986 284 007</b>
<b>Polo Classic</b>							
<b>1.9</b>	TDI	1,9	66	AGR	09.00→	<b>0 281 002 216</b>	<b>0 986 284 001</b>
	TDI [6V2]	1,9	66/81	AGR; ALH; ASV	10.99-09.01	<b>0 281 002 216</b>	<b>0 986 284 001</b>
<b>Polo Variant</b>							
<b>1.9</b>	TDI [6V5]	1,9	66/81	AGR; ALH; ASV	10.99-09.01	<b>0 281 002 216</b>	<b>0 986 284 001</b>
<b>Scirocco</b>							
<b>2.0</b>	TDI [137]	2,0	100/103/125	CFGB <D93>; CFHB <D94>; CFHC <D91>	11.10→	<b>0 281 002 956</b>	
			103/125	CBBB <D93>; CBDB <D91>	10.08-11.10	<b>0 281 002 735</b>	
<b>Sharan</b>							
<b>1.9</b>	TDI [7M8]	1,9	66/81	AFN; AHU			
				Fg.Nr. 7M..W..020 001→	08.97-02.00	<b>0 281 002 757</b>	
					WW	<b>0 280 217 121</b>	<b>0 986 280 202</b>
				ANU; AVG	03.99-02.00	<b>0 281 002 757</b>	
					WW	<b>0 280 217 121</b>	<b>0 986 280 202</b>
	TDI [7M9, 7M6]	1,9	66	ANU	04.00-03.10	<b>0 281 002 757</b>	
			96	ASZ	11.02-03.10	<b>0 281 002 461</b>	<b>0 986 284 007</b>
			110	BTB	01.05-06.06	<b>0 281 002 461</b>	<b>0 986 284 007</b>
	TDI, TDI 4 Motion [7M9, 7M6]	1,9	85	AUY	05.00-03.10	<b>0 281 002 757</b>	
				BVK	11.05-03.10	<b>0 281 002 531</b>	<b>0 986 284 009</b>
<b>2.0</b>	TDI [7M9, 7M6]	2,0	100/103	BRT; BVH	11.05-03.10	<b>0 281 002 461</b>	<b>0 986 284 007</b>
	TDI, TDI 4 Motion [7N1]	2,0	100/103/125	CFFA <D94>; CFFB <D91>; CFGB <D93>	05.10→	<b>0 281 002 956</b>	
<b>Tiguan</b>							
<b>2.0</b>	TDI, TDI 4 Motion [5N1]	2,0	81/100/103/125	CFFA <D94>; CFFB <D91>; CFFD <D96>; CFGB <D93>; CLJA <D91>	11.09-05.11	<b>0 281 002 956</b>	
			100/103/120/125	CBAA <D94>; CBAB <D91>; CBBA <D95>; CBBB <D93>	11.07-05.11	<b>0 281 002 735</b>	
<b>Touareg</b>							
<b>2.5</b>	TDI [7LA]	2,5	120/128	BAC; BLK	01.03-11.06	<b>0 281 002 461</b>	<b>0 986 284 007</b>
				BPD; BPE	01.06-11.06	<b>0 281 002 735</b>	
	TDI [7L6]	2,5	120/128	BPD; BPE	12.06-05.10	<b>0 281 002 735</b>	



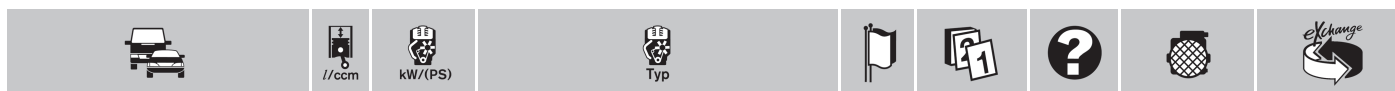

5.0 TDI [7L6]	5,0	230/258	BLE; CBWA		12.06-05.10	<b>0 281 002 461</b>	<b>0 986 284 007</b>
50 TDI [7LA]	5,0	230	AYH; BLE; BWF		11.02-11.06	<b>0 281 002 461</b>	<b>0 986 284 007</b>
<b>Touran</b>							
1.9 TDI [1T1]	1,9	66/74/77	AVQ; BKC; BLS; BRU; BXE; BXF; BXJ		02.03-11.06	<b>0 281 002 531</b>	<b>0 986 284 009</b>
TDI [1T2]	1,9	66/77	BLS; BXE; BXF; BXJ		11.06-05.10	<b>0 281 002 531</b>	<b>0 986 284 009</b>
2.0 TDI [1T1]	2,0	100/103/ 125	AZV; BKD; BMM; BMN		02.03-11.06	<b>0 281 002 461</b>	<b>0 986 284 007</b>
TDI [1T2]	2,0	100/103/ 125	AZV; BKD; BMM; BMN		11.06-05.10	<b>0 281 002 461</b>	<b>0 986 284 007</b>
TDI [1T3]	2,0	81/103/ 125	CFHC <D91>; CFJA <D93>; CLCA <D96>		05.10→	<b>0 281 002 956</b>	





**CITROEN**

<b>Jumper</b>					
2.8 HDi [U5]	2,8	94/107	8140 43N <SOFIM 2800 HDi>; 8140 43s <SOFIM 2800 HDi>	02.02-05.06	<b>0 281 002 184</b>
HDi [23]	2,8	94	8140 43s <SOFIM 2800 HDi>	09.00-02.02	<b>0 281 002 184</b>
HDI	2,8	93	8140 43s	09.05-09.09	<b>0 281 002 184</b>

**FIAT**

<b>Ducato</b>					
2.3 JTD [250..]	2,3	96/109		06.11→	GS <b>0 281 006 056</b> HAG <b>0 281 006 054</b>
3.0 JTD [250..]	3,0	130	F1CE348IE	06.11→	<b>0 281 006 056</b>
<b>Ducato 10</b>					
2.5 TD ECO [230..]	2,5	80	8140.47R <M7>	03.94-03.98	<b>0 281 002 087</b>
2.8 JTD EGR [230..]	2,8	94	8140.43S <M14>	08.00-03.02	<b>0 281 002 184</b>
JTD EGR 4x4 [234..]	2,8	94	8140.43S <M14>	08.00-03.02	<b>0 281 002 184</b>
<b>Ducato 11</b>					
2.3 JTD [250..]	2,3	88/96	F1AE0481D <M94>; F1AE0481N <M95>	06.06-12.08 01.09→	<b>0 281 002 763</b> <b>0 281 006 048</b>
2.8 JTD EGR [243..]	2,8	94	8140.43S <M20>	04.02-08.06	<b>0 281 002 184</b>
JTD EGR 4x4 [247..]	2,8	94	8140.43S <M20>	04.02-08.06	<b>0 281 002 184</b>
3.0 JTD [250..]	3,0	116	F1CE0481D <M96>	06.06-12.08 01.09→	<b>0 281 002 763</b> <b>0 281 006 048</b>
<b>Ducato 14</b>					
2.5 TD ECO [231..]	2,5	80	8140.47R <M7>	03.94-03.98	<b>0 281 002 087</b>
TD ECO 4x4 [234..]	2,5	80	8140.47R <M7>	03.94-03.98	<b>0 281 002 087</b>
2.8 JTD EGR [231..]	2,8	94	8140.43S <M14>	08.00-03.02	<b>0 281 002 184</b>
JTD EGR 4x4 [234..]	2,8	94	8140.43S <M14>	08.00-03.02	<b>0 281 002 184</b>
<b>Ducato 15</b>					
2.2 JTD [250..]	2,2	74	4HV <M93>	06.06→	<b>0 281 002 763</b>
2.3 JTD [250..]	2,3	88/96	F1AE0481D <M94>; F1AE0481N <M95>	06.06-12.08 01.09→	<b>0 281 002 763</b> <b>0 281 006 048</b>
JTD EGR [244..]	2,3	81	F1AE0481C <M11>	01.08→	<b>0 281 002 764</b>
2.8 JTD EGR [244..]	2,8	94	8140.43S <M20>	04.02-08.06	<b>0 281 002 184</b>
JTD EGR 4x4 [247..]	2,8	94	8140.43S <M20>	04.02-08.06	<b>0 281 002 184</b>
3.0 JTD [250..]	3,0	116	F1CE0481D <M96>	06.06-12.08 01.09→	<b>0 281 002 763</b> <b>0 281 006 048</b>
<b>Ducato 17</b>					
2.2 JTD [250..]	2,2	74	4HV <M93>	06.06→	<b>0 281 002 763</b>
2.3 JTD [250..]	2,3	88/96	F1AE0481D <M94>; F1AE0481N <M95>	06.06-12.08 01.09→	<b>0 281 002 763</b> <b>0 281 006 048</b>
JTD Maxi [251..]	2,3	88/96	F1AE0481D <M94>; F1AE0481N <M95>	06.06→	<b>0 281 002 763</b>
3.0 JTD [250..]	3,0	116	F1CE0481D <M96>	06.06-12.08 01.09→	<b>0 281 002 763</b> <b>0 281 006 048</b>
JTD Maxi [251..]	3,0	116	F1CE0481D <M96>	06.06→	<b>0 281 002 763</b>
<b>Ducato 18</b>					
2.3 JTD EGR [245..]	2,3	81	F1AE0481C <M11>	01.08→	<b>0 281 002 764</b>
2.5 TD ECO [232..]	2,5	80	8140.47R <M7>	03.94-03.98	<b>0 281 002 087</b>
2.8 JTD EGR [232..]	2,8	94	8140.43S <M14>	08.00-03.02	<b>0 281 002 184</b>
JTD EGR [245..]	2,8	94	8140.43S <M20>	04.02-08.06	<b>0 281 002 184</b>
JTD EGR 4x4 [234..]	2,8	94	8140.43S <M14>	08.00-03.02	<b>0 281 002 184</b>
JTD EGR 4x4 [247..]	2,8	94	8140.43S <M20>	04.02-08.06	<b>0 281 002 184</b>
<b>Ducato 20</b>					
2.3 JTD Maxi [251..]	2,3	88/96	F1AE0481D <M94>; F1AE0481N <M95>	06.06→	<b>0 281 002 763</b>
3.0 JTD [251..]	3,0	107/115	F1CE3481M <M99>; F1CE3481N <M97>	09.10→	<b>0 281 006 056</b>
JTD Maxi [251..]	3,0	116	F1CE0481D <M96>	06.06→	<b>0 281 002 763</b>





## HYUNDAI

## H-1

2.5 CRDi	2,5	103	D4CB	08.03-12.06	0 281 002 554
----------	-----	-----	------	-------------	---------------

## Starex

2.5 CRDi	2,5	103/107	<A2,51Gen>; D4CB	10.02→	0 281 002 554
----------	-----	---------	------------------	--------	---------------

## IVECO

## Daily

29 L 10, 12, 14 [06]	2,3	71/85/ 100	F1AE0481F...; F1AE0481G...; F1AE0481H...	04.06→	TW	0 281 002 764
----------------------	-----	---------------	--	--------	----	---------------

0 281 006 056

35 -10 Turbo I.D.	2,5	80	8140.47R.2790	07.92-04.97		0 281 002 087
-------------------	-----	----	---------------	-------------	--	---------------

35 C 10, 12, 14 [06]	2,3	71/85/ 100	F1AE0481F...; F1AE0481G...; F1AE0481H...;	04.06→	TW	0 281 002 764
----------------------	-----	---------------	---	--------	----	---------------

0 281 006 056

11, 13 [09]	2,3	78/93	F1AE0481U...; F1AE0481V...	06.09→	TW	0 281 002 764
-------------	-----	-------	----------------------------	--------	----	---------------

0 281 006 056

14, 17 [09]	3,0	103/125	F1CE3481C...; F1CE3481L...	06.09→	TW	0 281 002 764
-------------	-----	---------	----------------------------	--------	----	---------------

0 281 006 056

15, 18 [06]	3,0	107/130	F1CE0481F...; F1CE0481H...	04.06→	TW	0 281 002 764
-------------	-----	---------	----------------------------	--------	----	---------------

0 281 006 056

35 S 10, 12, 14 [06]	2,3	71/85/ 100	F1AE0481F...; F1AE0481G...; F1AE0481H...;	04.06→	TW	0 281 002 764
----------------------	-----	---------------	---	--------	----	---------------

0 281 006 056

11, 13 [09]	2,3	78/93	F1AE0481U...; F1AE0481V...	06.09→	TW	0 281 002 764
-------------	-----	-------	----------------------------	--------	----	---------------

0 281 006 056

14, 17, 18 [09]	3,0	103/125/ 130	F1CE3481C...; F1CE3481H...; F1CE3481L...	06.09→	TW	0 281 002 764
-----------------	-----	-----------------	--	--------	----	---------------

0 281 006 056

15, 18 [06]	3,0	107/130	F1CE0481F...; F1CE0481H...	04.06-05.09	TW	0 281 002 764
-------------	-----	---------	----------------------------	-------------	----	---------------

0 281 006 056

40 C 10, 12 [06]	2,3	71/85	F1AE0481F...; F1AE0481G...	04.06-05.09	TW	0 281 002 764
------------------	-----	-------	----------------------------	-------------	----	---------------

0 281 006 056

11, 13 [09]	2,3	78/93	F1AE0481U...; F1AE0481V...	06.09→	TW	0 281 002 764
-------------	-----	-------	----------------------------	--------	----	---------------

0 281 006 056

14, 17 [09]	3,0	103/125	F1CE3481C...; F1CE3481CC...	06.09→	TW	0 281 002 764
-------------	-----	---------	-----------------------------	--------	----	---------------

0 281 006 056

15, 18 [06]	3,0	107/130	F1CE0481...; F1CE0481H...	04.06→	TW	0 281 002 764
-------------	-----	---------	---------------------------	--------	----	---------------

0 281 006 056

45 C 14, 15, 17 [09]	3,0	103/107/ 125	F1CE0481F...; F1CE0481HA...; F1CE3481LC...	07.09→	TW	0 281 002 764
----------------------	-----	-----------------	--	--------	----	---------------

0 281 006 056

15, 18 [06]	3,0	107/130	F1CE0481F...; F1CE0481H...	04.06→	TW	0 281 002 764
-------------	-----	---------	----------------------------	--------	----	---------------

0 281 006 056

50 C 12 [06]	2,3	85	F1AE0481G...	04.06→	TW	0 281 002 764
--------------	-----	----	--------------	--------	----	---------------

0 281 006 056

14, 17 [09]	3,0	103/125	F1CE3481C...; F1CE3481L...	06.09→	TW	0 281 002 764
-------------	-----	---------	----------------------------	--------	----	---------------

0 281 006 056

15, 18 [06]	3,0	107/130	F1CE0481F...; F1CE0481H...	04.06→	TW	0 281 002 764
-------------	-----	---------	----------------------------	--------	----	---------------

0 281 006 056

55 S 17 [09]	3,0	125	F1CE3481CC...	06.09→	TW	0 281 002 764
--------------	-----	-----	---------------	--------	----	---------------

0 281 006 056

18 [06]	3,0	130	F1CE0481H...	04.06→	TW	0 281 002 764
---------	-----	-----	--------------	--------	----	---------------

0 281 006 056

60 C 14 [09]	3,0	103	F1CE3481L...	11.10→	TW	0 281 002 764
--------------	-----	-----	--------------	--------	----	---------------

0 281 006 056

15, 18 [06]	3,0	107/130	F1CE0481F...; F1CE0481H...	04.06→	TW	0 281 002 764
-------------	-----	---------	----------------------------	--------	----	---------------

0 281 006 056

65 C 14, 17 [09]	3,0	103/125	F1CE3481C...; F1CE3481L...	06.09→	TW	0 281 002 764
------------------	-----	---------	----------------------------	--------	----	---------------

0 281 006 056

15, 18 [06]	3,0	107/130	F1CE0481F...; F1CE0481H...	04.06→	TW	0 281 002 764
-------------	-----	---------	----------------------------	--------	----	---------------

0 281 006 056

70 C 14, 15, 17, 18 [09]	3,0	103/107/ 125/130	F1CE3481C...; F1CE3481F...; F1CE3481H...;	06.10→	TW	0 281 002 764
--------------------------	-----	---------------------	---	--------	----	---------------

0 281 006 056





**KIA**

<b>Bongo III</b>						
2.9 CRDI Coach	2,9	91			02.04-05.05	<b>0 281 002 554</b>
<b>K 2900</b>						
2.9 CRDI	2,9	92	<2.9L-J3>		05.07→	<b>0 281 002 721</b>
					EU4	<b>0 281 002 554</b>
					EU4	<b>0 281 002 554</b>

**MERCEDES-BENZ**

<b>Sprinter</b>						
208 CDI [T1N]	2,2	60	OM 611.987 DE LA		04.00-05.06	<b>0 280 217 517</b>
209 CDI [NCV3]	2,1	65	OM 646.984 DE 22 LA <Euro 4>		04.06-03.09	<b>0 281 002 896</b>
211 CDI [NCV3]	2,1	80	OM 646.985 DE 22 LA <Euro 4>		04.06→	<b>0 281 002 896</b>
CDI [T1N]	2,2	80	OM 611.981 DE LA		04.00-05.06	<b>0 280 217 517</b>
213 CDI [NCV3]	2,1	95	OM 646.986 DE 22 LA <Euro 4>		04.06-03.09	<b>0 281 002 896</b>
CDI [T1N]	2,2	95	OM 611.981 DE LA		04.00-05.06	<b>0 280 217 517</b>
215 CDI [NCV3]	2,1	110	OM 646... <Euro 4>		04.06→	<b>0 281 002 896</b>
216 CDI [T1N]	2,7	115	OM 612.981 DE LA		04.00-05.06	<b>0 280 217 517</b>
218 CDI [NCV3]	3,0	135	OM 642... <Euro 4>		04.06-03.09	<b>0 281 002 896</b>
308 CDI [T1N]	2,2	60	OM 611.987 DE LA		04.00-05.06	<b>0 280 217 517</b>
309 CDI [NCV3]	2,1	65	OM 646.984 DE 22 LA <Euro 4>		04.06-03.09	<b>0 281 002 896</b>
311 CDI [NCV3]	2,1	80	OM 646.985 DE 22 LA <Euro 4>		04.06→	<b>0 281 002 896</b>
CDI [T1N]	2,1	80	OM 611.981 DE LA		08.02-05.06	<b>0 280 217 517</b>
	2,2	80	OM 611.981 DE LA		04.00-05.06	<b>0 280 217 517</b>
313 CDI [NCV3]	2,1	95	OM 646.986 DE 22 LA <Euro 4>		04.06-03.09	<b>0 281 002 896</b>
CDI [T1N]	2,2	95	OM 611.981 DE LA		04.00-05.06	<b>0 280 217 517</b>
315 CDI [NCV3]	2,1	110	OM 646... <Euro 4>		04.06→	<b>0 281 002 896</b>
316 CDI [T1N]	2,7	115	OM 647.981 DE 27 LA		10.04-05.06	<b>0 281 002 656</b>
CDI, CDI James Cook [T1N]	2,7	115	OM 612.981 DE LA		04.00-05.06	<b>0 280 217 517</b>
318 CDI [NCV3]	3,0	135	OM 642... <Euro 4>		04.06-03.09	<b>0 281 002 896</b>
408 CDI [T1N]	2,2	60	OM 611.987 DE LA		04.00-05.06	<b>0 280 217 517</b>
411 CDI [NCV3]	2,1	80	OM 646.985 DE 22 LA <Euro 4>		04.06-03.09	<b>0 281 002 896</b>
CDI [T1N]	2,2	80	OM 611.981 DE LA		04.00-05.06	<b>0 280 217 517</b>
413 CDI [T1N]	2,2	95	OM 611.981 DE LA		04.00-05.06	<b>0 280 217 517</b>
415 CDI [NCV3]	2,1	110	OM 646... <Euro 4>		04.06-03.09	<b>0 281 002 896</b>
416 CDI [T1N]	2,7	115	OM 612.981 DE LA		04.00-05.06	<b>0 280 217 517</b>
			OM 647.981 DE 27 LA		10.04-05.06	<b>0 281 002 656</b>
418 CDI [NCV3]	3,0	135	OM 642... <Euro 4>		04.06-03.09	<b>0 281 002 896</b>
509 CDI [NCV3]	2,1	65	OM 646.984 DE 22 LA <Euro 4>		04.06-03.09	<b>0 281 002 896</b>
511 CDI [NCV3]	2,1	80	OM 646.985 DE 22 LA <Euro 4>		04.06-03.09	<b>0 281 002 896</b>
515 CDI [NCV3]	2,1	110	OM 646... <Euro 4>		04.06-03.09	<b>0 281 002 896</b>
518 CDI [NCV3]	3,0	135	OM 642... <Euro 4>		04.06-03.09	<b>0 281 002 896</b>
616 CDI [T1N]	2,7	115	OM 612.981 DE LA		02.01-05.06	<b>0 280 217 517</b>
<b>Vito</b>						
108 CDI [638 TON]	2,2	60	OM 611.980		04.99-09.03	<b>0 280 217 114</b>
D [638 TON]	2,3	60	OM 601.942		11.95-09.03	<b>0 280 217 523</b>
109 CDI [639 TON]	2,1	65/70	OM 646.980 <OM 646 DE22LA>; OM 646.983 <OM 646 DE22LA>		10.03-07.10	<b>0 281 002 585</b>
110 CDI [638 TON]	2,2	75	OM 611.980		04.99-09.03	<b>0 280 217 114</b>
D [638 TON]	2,3	72	OM 601.970		11.95-09.03	<b>0 280 217 523</b>
111 CDI [639 TON]	2,1	80/85	OM 646.981 <OM 646 DE22LA>; OM 646.982 <OM 646 DE22LA>		10.03-07.10	<b>0 281 002 585</b>
112 CDI [638 TON]	2,2	90	OM 611.980		04.99-09.03	<b>0 280 217 114</b>
115 CDI [639 TON]	2,1	110	OM 646.982 <OM 646 DE22LA>		10.03-07.10	<b>0 281 002 585</b>
120 CDI [639 TON]	3,0	150	642.990 <OM 642 DE30LA>			
			Fg.Nr. →298499		04.06-07.10	EU5 <b>0 281 002 656</b>
			Fg.Nr. 298500→		04.06-07.10	EU5 <b>0 281 002 896</b>







l/ccm



kW/(PS)



Typ



## PEUGEOT

## Boxer

2.8 HDi [U3]	2,8	94	8140 43s <SOFIM 2800 HDi>	09.00-02.02	0 281 002 184
HDi [U5]	2,8	94/107	8140 43N <SOFIM 2800 HDi>; 8140 43s <SOFIM 2800 HDi>	02.02-05.06	0 281 002 184
HDi	2,8	93	8140 43s	09.05-09.09	0 281 002 184

## VW (VOLKSWAGEN)

## California T4

2.5 TDI [70, 7D]	2,5	65/75	AJT; AUF		
			Fg.Nr. →70..1H048 284 →70..1X047 893	05.98-08.00	0 281 002 216 0 986 284 001
			Fg.Nr. 70..1H048 285 → 70..1X047 894→	09.00-06.03	0 281 002 463 0 986 284 008
		111	AHY		
			Fg.Nr. →70..1..001 319	05.98-05.00	0 280 217 529 0 986 280 204
			Fg.Nr. 70..1..001 320→	06.00-09.00	0 281 002 461 0 986 284 007
			AXG	09.00-06.03	0 281 002 461 0 986 284 007
TDI, TDI Syncro [70, 7D]	2,5	65/75	AXL; AYC; AYY	04.01-06.03	0 281 002 463 0 986 284 008
		75	ACV		
			Fg.Nr. →70..1H048 284 →70..1X047 893	05.98-08.00	0 281 002 216 0 986 284 001
			Fg.Nr. 70..1H048 285 → 70..1X047 894→	09.00-06.03	0 281 002 463 0 986 284 008

## California T5

1.9 TDI [7H]	1,9	62/63/ 75/77	AXB; AXC; BRR; BRS	04.03-11.09	0 281 002 531 0 986 284 009
2.0 TDI, TDI 4 Motion [7E]	2,0	62/75/ 84/100/ 103/132	CAAA <D54>; CAAB <D55>; CAAC <D94>; CAAD <DK3>; CAAE <D94>; CCHA <D91>; CCHB <D94>; CFCA <D49>	09.09→	0 281 002 956
2.5 TDI, TDI 4 Motion [7H]	2,5	96/120/ 128	AXD; AXE; BLJ	02.03-11.09	0 281 002 461 0 986 284 007
		96/128	BNZ; BPC	01.06-11.09	0 281 002 735

## Caravelle T4

2.5 TDI [70, 7D]	2,5	65/75	AJT; AUF		
			Fg.Nr. →70..1H048 284 →70..1X047 893	05.98-08.00	0 281 002 216 0 986 284 001
			Fg.Nr. 70..1H048 285 → 70..1X047 894→	09.00-06.03	0 281 002 463 0 986 284 008
		111	AHY		
			Fg.Nr. →70..1..001 319	05.98-05.00	0 280 217 529 0 986 280 204
			Fg.Nr. 70..1..001 320→	06.00-09.00	0 281 002 461 0 986 284 007
			AXG	09.00-06.03	0 281 002 461 0 986 284 007
TDI, TDI Syncro [70, 7D]	2,5	65/75	AXL; AYC; AYY	04.01-06.03	0 281 002 463 0 986 284 008
		75	ACV		
			Fg.Nr. →70..1H048 284 →70..1X047 893	05.98-08.00	0 281 002 216 0 986 284 001
			Fg.Nr. 70..1H048 285 → 70..1X047 894→	09.00-06.03	0 281 002 463 0 986 284 008

## Caravelle T5

1.9 TDI [7H]	1,9	62/63/ 75/77	AXB; AXC; BRR; BRS	04.03-11.09	0 281 002 531 0 986 284 009
2.0 TDI, TDI 4 Motion [7E]	2,0	62/75/ 84/100/ 103/132	CAAA <D54>; CAAB <D55>; CAAC <D94>; CAAD <DK3>; CAAE <D94>; CCHA <D91>; CCHB <D94>; CFCA <D49>	09.09→	0 281 002 956
2.5 TDI, TDI 4 Motion [7H]	2,5	96/120/ 128	AXD; AXE; BLJ	02.03-11.09	0 281 002 461 0 986 284 007
		96/128	BNZ; BPC	01.06-11.09	0 281 002 735

## Crafter 30

2.5 TDI [2E, 2F]	2,5	65/80/ 100/120	BJJ <D5K>; BJK <D5L>; BJL <D5M>; BJM <D5N>; CEBA <D5K>; CEBA <D5L>; CECA <D5M>; CECB <D5N>	04.06→	0 281 002 896
------------------	-----	-------------------	--	--------	---------------

## Crafter 35

2.5 TDI [2E, 2F]	2,5	65/80/ 100/120	BJJ <D5K>; BJK <D5L>; BJL <D5M>; BJM <D5N>; CEBA <D5K>; CEBA <D5L>; CECA <D5M>; CECB <D5N>	04.06→	0 281 002 896
------------------	-----	-------------------	--	--------	---------------





◀ VW

**Crafter 50**

2.5 TDI [2E, 2F]	2,5	80/100/120	BJK <D5L>; BJJ <D5M>; BJM <D5N>; CEBB <D5L>; CECA <D5M>; CECB <D5N>	04.06→	<b>0 281 002 896</b>
------------------	-----	------------	---	--------	----------------------

**LT**

28 2.5 SDI [2D, 2H]	2,5	55	AGX Fg.Nr. 2D..X..027 194→	03.99-04.01	<b>0 281 002 216</b>	<b>0 986 284 001</b>
2.5 TDI [2D, 2H]	2,5	61/70/80	AVR; BBE; BBF	04.01-04.06	<b>0 281 002 463</b>	<b>0 986 284 008</b>
		66	APA	05.99-04.01	<b>0 281 002 216</b>	<b>0 986 284 001</b>
		80	ANJ Fg.Nr. →2D..1..013 334	05.99-08.00	<b>0 281 002 216</b>	<b>0 986 284 001</b>
			Fg.Nr. 2D..1..013 335→	09.00-04.06	<b>0 281 002 463</b>	<b>0 986 284 008</b>
2.8 D Turbo, 2.8 TDI [2D, 2H]	2,8	92/96/116	AGK; ATA; AUH; BCQ	07.97-04.06	<b>0 281 002 461</b>	<b>0 986 284 007</b>
35 2.5 SDI [2D, 2H]	2,5	55	AGX Fg.Nr. 2D..X..027 194→	03.99-04.01	<b>0 281 002 216</b>	<b>0 986 284 001</b>
2.5 TDI [2D, 2H]	2,5	61/70/80	AVR; BBE; BBF	04.01-04.06	<b>0 281 002 463</b>	<b>0 986 284 008</b>
		66	APA	05.99-04.01	<b>0 281 002 216</b>	<b>0 986 284 001</b>
		80	ANJ Fg.Nr. →2D..1..013 334	05.99-08.00	<b>0 281 002 216</b>	<b>0 986 284 001</b>
			Fg.Nr. 2D..1..013 335→	09.00-04.06	<b>0 281 002 463</b>	<b>0 986 284 008</b>
2.8 D Turbo, 2.8 TDI [2D, 2H]	2,8	92/96/116	AGK; ATA; AUH; BCQ	07.97-04.06	<b>0 281 002 461</b>	<b>0 986 284 007</b>
46 2.5 SDI [2D, 2H]	2,5	55	AGX Fg.Nr. 2D..X..027 194→	03.99-04.01	<b>0 281 002 216</b>	<b>0 986 284 001</b>
2.5 TDI [2D, 2H]	2,5	61/70/80	AVR; BBE; BBF	04.01-04.06	<b>0 281 002 463</b>	<b>0 986 284 008</b>
		66	APA	05.99-04.01	<b>0 281 002 216</b>	<b>0 986 284 001</b>
		80	ANJ Fg.Nr. →2D..1..013 334	05.99-08.00	<b>0 281 002 216</b>	<b>0 986 284 001</b>
			Fg.Nr. 2D..1..013 335→	09.00-04.06	<b>0 281 002 463</b>	<b>0 986 284 008</b>
2.8 D Turbo, 2.8 TDI [2D, 2H]	2,8	92/96/116	AGK; ATA; AUH	07.97-04.06	<b>0 281 002 461</b>	<b>0 986 284 007</b>

**Multivan T4**

2.5 TDI [70, 7D]	2,5	65/75	AJT; AUF Fg.Nr. →70..1H048 284 →70..1X047 893	05.98-08.00	<b>0 281 002 216</b>	<b>0 986 284 001</b>
			Fg.Nr. 70..1H048 285→70..1X047 894→	09.00-06.03	<b>0 281 002 463</b>	<b>0 986 284 008</b>
		111	AHY Fg.Nr. →70..1..001 319	05.98-05.00	<b>0 280 217 529</b>	<b>0 986 280 204</b>
			Fg.Nr. 70..1..001 320→	06.00-09.00	<b>0 281 002 461</b>	<b>0 986 284 007</b>
			AXG	09.00-06.03	<b>0 281 002 461</b>	<b>0 986 284 007</b>
TDI, TDI Syncro [70, 7D]	2,5	65/75	AXL; AYC; AYY	04.01-06.03	<b>0 281 002 463</b>	<b>0 986 284 008</b>
		75	ACV Fg.Nr. →70..1H048 284 →70..1X047 893	05.98-08.00	<b>0 281 002 216</b>	<b>0 986 284 001</b>
			Fg.Nr. 70..1H048 285→70..1X047 894→	09.00-06.03	<b>0 281 002 463</b>	<b>0 986 284 008</b>

**Multivan T5**

1.9 TDI [7H]	1,9	62/63/75/77	AXB; AXC; BRR; BRS	04.03-11.09	<b>0 281 002 531</b>	<b>0 986 284 009</b>
2.0 TDI, TDI 4 Motion [7E]	2,0	62/75/84/100/103/132	CAA <D54>; CAAB <D55>; CAAC <D94>; CAAD <DK3>; CAAE <D94>; CCHA <D91>; CCHB <D94>; CFCA <D49>	09.09→	<b>0 281 002 956</b>	
2.5 TDI, TDI 4 Motion [7H]	2,5	96/120/128	AXD; AXE; BLJ	02.03-11.09	<b>0 281 002 461</b>	<b>0 986 284 007</b>
		96/128	BNZ; BPC	01.06-11.09	<b>0 281 002 735</b>	

**Transporter T4**

2.5 TDI [70, 7D]	2,5	65/75	AJT; AUF Fg.Nr. →70..1H048 284 →70..1X047 893	05.98-08.00	<b>0 281 002 216</b>	<b>0 986 284 001</b>
			Fg.Nr. 70..1H048 285→70..1X047 894→	09.00-06.03	<b>0 281 002 463</b>	<b>0 986 284 008</b>
		111	AHY Fg.Nr. →70..1..001 319	05.98-05.00	<b>0 280 217 529</b>	<b>0 986 280 204</b>
			Fg.Nr. 70..1..001 320→	06.00-09.00	<b>0 281 002 461</b>	<b>0 986 284 007</b>
			AXG	09.00-06.03	<b>0 281 002 461</b>	<b>0 986 284 007</b>





2.5 TDI, TDI Syncro [70, 7D]	2,5	65/75 75	AXL; AYC; AYY ACV	04.01-06.03	<b>0 281 002 4630 986 284 008</b>	
			Fg.Nr. →70..1H048 284 →70..1X047 893	05.98-08.00	<b>0 281 002 216</b>	<b>0 986 284 001</b>
			Fg.Nr. 70..1H048 285→ 70..1X047 894→	09.00-06.03	<b>0 281 002 463</b>	<b>0 986 284 008</b>
<b>Transporter T5</b>						
1.9 TDI [7H]	1,9	62/63/ 75/77	AXB; AXC; BRR; BRS	04.03-11.09	<b>0 281 002 531</b>	<b>0 986 284 009</b>
TDI [7J]	1,9	62/63/ 75/77	AXB; AXC; BRR; BRS	04.03-11.09	<b>0 281 002 531</b>	<b>0 986 284 009</b>
2.0 TDI, TDI 4 Motion [7E]	2,0	62/75/ 84/100/ 103/132	CAAA <D54>; CAAB <D55>; CAAC <D94>; CAAD <DK3>; CAAE <D94>; CCHA <D91>; CCHB <D94>; CFCA <D49>	09.09→	<b>0 281 002 956</b>	
TDI, TDI 4 Motion [7F]	2,0	62/75/ 84/100/ 103/132	CAAA <D54>; CAAB <D55>; CAAC <D94>; CAAD <DK3>; CAAE <D94>; CFCA <D49>	09.09→	<b>0 281 002 956</b>	
2.5 TDI, TDI 4 Motion [7H]	2,5	96/120/ 128	AXD; AXE; BLJ	02.03-11.09	<b>0 281 002 461</b>	<b>0 986 284 007</b>
		96/128	BNZ; BPC	01.06-11.09	<b>0 281 002 735</b>	
TDI, TDI 4 Motion [7J]	2,5	96/128	AXD; AXE BNZ; BPC	04.03-11.09 06.06-11.09	<b>0 281 002 461</b>	<b>0 986 284 007</b> <b>0 281 002 735</b>





**IVECO**

<b>EuroCargo</b>						
180 E 24	5,9	176	F4AE0681B*C...		09.00-08.03	0 414 701 006 0 986 441 003
<b>EuroMover</b>						
190 E 24	7,8	180	F2BE0681D*A... <Euro 2>			
			Mot.Nr. →13740		08.00-03.06	0 414 700 002 0 986 441 002
			Mot.Nr. 13741→		08.00-03.06	0 414 700 003 0 986 441 012
260 E 24	7,8	180	F2BE0681D...			
			Mot.Nr. →13740		08.00-03.06	0 414 700 002 0 986 441 002
			Mot.Nr. 13741→		08.00-03.06	0 414 700 003 0 986 441 012
<b>EuroStar</b>						
190 E 39	10,5	287	F3AE0681E*A...		08.00-08.03	0 414 701 006 0 986 441 003
43	10,3	316	F3AE0681D*A...; F3AE0681D*B...		08.00-08.03	0 414 701 006 0 986 441 003
260 E 39	10,5	287	F3AE0681E*A...		08.00-08.03	0 414 701 006 0 986 441 003
40, 43	10,3	294/316	F3AE0681B*B...; F3AE0681D*A...; F3AE0681D*B...		08.00-09.04	0 414 701 006 0 986 441 003
48	12,9	353	F3BE0681E*A...		08.97-08.03	0 414 701 013 0 986 441 013
440 E 39, 40, 43	10,3	287/294/316	F3AE0681B*B...; F3AE0681D*A...; F3AE0681E*A...		08.99-09.04	0 414 701 006 0 986 441 003
46, 48	13,0	339/353	F3BE0681E*A...; F3BE0681F*...		08.00-08.03	0 414 701 013 0 986 441 013
<b>EuroTech</b>						
190 E 24, 27, 31, 35	7,8	180/200/228/259	F2BE0681A*A...-Euro2; F2BE0681A*B...-Euro3; F2BE0681B... <Euro2>; F2BE0681B... <Euro3>; F2BE0681C...; F2BE0681D*A... <Euro 2>; F2BE0681D*B... <Euro 3>; F2BE0681F...			
			Mot.Nr. →13740		08.00-08.03	0 414 700 002 0 986 441 002
			Mot.Nr. 13741→		08.00-08.03	0 414 700 003 0 986 441 012
39	10,5	287	F3AE0681E*A...		08.00-08.03	0 414 701 006 0 986 441 003
40, 43	10,3	294/316	F3AE0681B*B...; F3AE0681D*A...; F3AE0681D*B...		08.00-09.04	0 414 701 006 0 986 441 003
260 E 24, 27, 31, 35	7,8	180/200/228/259	F2BE0681A*A... <Euro2>; F2BE0681A*B... <Euro3>; F2BE0681B*A... <Euro2>; F2BE0681B*B... <Euro3>; F2BE0681C...; F2BE0681D...; F2BE0681F...			
			Mot.Nr. →13740		08.00-08.03	0 414 700 002 0 986 441 002
			Mot.Nr. 13741→		08.00-08.03	0 414 700 003 0 986 441 012
39	10,5	287	F3AE0681E*A...		08.00-08.03	0 414 701 006 0 986 441 003
40, 43	10,3	294/316	F3AE0681B*B...; F3AE0681D*A...; F3AE0681D*B...		08.00-09.04	0 414 701 006 0 986 441 003
440 E 31, 35	7,8	228/259	F2BE0681A*A...-Euro2; F2BE0681A*B...-Euro3; F2BE0681B*A...-Euro2; F2BE0681B*B...-Euro3			
			Mot.Nr. →13740		08.00-08.03	0 414 700 002 0 986 441 002
			Mot.Nr. 13741→		08.00-08.03	0 414 700 003 0 986 441 012
40, 43	10,3	294/316	F3AE0681B*B...; F3AE0681D*A...		08.00-09.04	0 414 701 006 0 986 441 003
<b>EuroTrakker</b>						
180 E 24, 27	7,8	180/200	F2BE0681D*A...; F2BE0681D*B...; F2BE0681F*...			
			Mot.Nr. →13740		08.00-08.04	0 414 700 002 0 986 441 002
			Mot.Nr. 13741→		08.00-08.04	0 414 700 003 0 986 441 012
190 E 24, 27, 31, 35	7,8	180/200/228/259	F2BE0681A*A...-Euro2; F2BE0681A*B...-Euro3; F2BE0681B... <Euro2>; F2BE0681B... <Euro3>; F2BE0681D*A... <Euro 2>; F2BE0681D*B... <Euro 3>; F2BE0681F...			
			Mot.Nr. →13740		08.00-08.04	0 414 700 002 0 986 441 002
			Mot.Nr. 13741→		08.00-08.04	0 414 700 003 0 986 441 012
38, 44	13,0	280/324	F3BE0681C*...; F3BE0681G...		08.00-08.04	0 414 701 013 0 986 441 013
260 E 31, 35	7,8	228/259	F2BE0681A*A... <Euro2>; F2BE0681A*B... <Euro3>; F2BE0681B*A... <Euro2>; F2BE0681B*B... <Euro3>			
			Mot.Nr. →13740		08.00-08.04	0 414 700 002 0 986 441 002
			Mot.Nr. 13741→		08.00-08.04	0 414 700 003 0 986 441 012
38, 44, 48	13,0	280/324/353	F3BE0681C*B...; F3BE0681E*B...; F3BE0681G*B...		08.00-08.04	0 414 701 013 0 986 441 013
340 E 35	7,8	259	F2BE0681A*A... <Euro2>; F2BE0681A*B... <Euro3>			
			Mot.Nr. →13740		08.00-08.04	0 414 700 002 0 986 441 002
			Mot.Nr. 13741→		08.00-08.04	0 414 700 003 0 986 441 012
38, 44	13,0	280/324	F3BE0681C*B...; F3BE0681G*B...		08.00-08.04	0 414 701 013 0 986 441 013





<b>380 E 35</b>	7,8	259	F2BE0681A*A... <Euro2>; F2BE0681A*B... <Euro3>					
			Mot.Nr. →13740	08.00-08.04		<b>0 414 700 002</b>	<b>0 986 441 002</b>	
			Mot.Nr. 13741→	08.00-08.04		<b>0 414 700 003</b>	<b>0 986 441 012</b>	
38, 44, 48	13,0	280/324/353	F3BE0681C*B...; F3BE0681E*B...; F3BE0681G*B...	08.00-08.04		<b>0 414 701 013</b>	<b>0 986 441 013</b>	
<b>400 E 35</b>	7,8	259	F2BE0681A*A... <Euro2>; F2BE0681A*B... <Euro3>					
			Mot.Nr. →13740	08.00-08.04		<b>0 414 700 002</b>	<b>0 986 441 002</b>	
			Mot.Nr. 13741→	08.00-08.04		<b>0 414 700 003</b>	<b>0 986 441 012</b>	
38, 44	13,0	280/324	F3BE0681C*B...; F3BE0681G*B...	08.00-08.04		<b>0 414 701 013</b>	<b>0 986 441 013</b>	
<b>410 E 35</b>	7,8	259	F2BE0681A*A... <Euro2>; F2BE0681A*B... <Euro3>					
			Mot.Nr. →13740	08.00-08.04		<b>0 414 700 002</b>	<b>0 986 441 002</b>	
			Mot.Nr. 13741→	08.00-08.04		<b>0 414 700 003</b>	<b>0 986 441 012</b>	
38, 44, 48	13,0	280/324/353	F3BE0681C*B...; F3BE0681E*B...; F3BE0681G*B...	08.00-08.04		<b>0 414 701 013</b>	<b>0 986 441 013</b>	
<b>440 E 38, 44</b>	13,0	280/324	F3BE0681C*B...; F3BE0681G*B...	08.00-08.04		<b>0 414 701 013</b>	<b>0 986 441 013</b>	
39	10,5	287	F3AE0681E*A...	08.00-08.04		<b>0 414 701 006</b>	<b>0 986 441 003</b>	
<b>720 E 44, 48</b>	13,0	324/353	F3BE0681C*B...; F3BE0681E*B...	08.00-08.04		<b>0 414 701 013</b>	<b>0 986 441 013</b>	
<b>Stralis</b>								
<b>L 190 S 42, 45 [07]</b>	10,3	309/331	F3AE3681A*...; F3AE3681D*...	04.07→		<b>0 414 703 008</b>	<b>0 986 441 026</b>	
50 [07]	12,9	368	F3BE3681B*...	04.07→	TW	<b>0 414 703 004</b>	<b>0 986 441 025</b>	
						<b>0 414 703 008</b>	<b>0 986 441 026</b>	
<b>L 260 S 50 [07]</b>	12,9	368	F3BE3681B*...	04.07→	TW	<b>0 414 703 004</b>	<b>0 986 441 025</b>	
						<b>0 414 703 008</b>	<b>0 986 441 026</b>	
56 [07]	12,9	412	F3BE3681A*...	04.07→		<b>0 414 703 004</b>	<b>0 986 441 025</b>	
<b>L 440 S 42, 45 [07]</b>	10,3	309/331	F3AE3681A*...; F3AE3681D*...	04.07→		<b>0 414 703 008</b>	<b>0 986 441 026</b>	
50 [07]	12,9	368	F3BE3681B*...	04.07→	TW	<b>0 414 703 004</b>	<b>0 986 441 025</b>	
						<b>0 414 703 008</b>	<b>0 986 441 026</b>	
56 [07]	12,9	412	F3BE3681A*...	04.07→		<b>0 414 703 008</b>	<b>0 986 441 026</b>	
<b>N 190 S 31, 33, 36 [07]</b>	7,8	228/243/265	F2BE3681A*...; F2BE3681B*...; F2BE3681C*...	04.07→		<b>0 414 700 006</b>		
<b>N 260 S 31, 33, 36 [07]</b>	7,8	228/243/265	F2BE3681A*...; F2BE3681B*...; F2BE3681C*...	04.07→		<b>0 414 700 006</b>		
<b>N 440 S 33, 36 [07]</b>	7,8	243/265	F2BE3681A*...; F2BE3681B*...	04.07→		<b>0 414 700 006</b>		
<b>190 S 27, 30, 31, 35</b>	7,8	200/218/228/259	F2BE0681A*... <Euro2/3>; F2BE0681B*B...-Euro3; F2BE0681E...; F2BE0681F...					
			Mot.Nr. →13740	08.03-03.06		<b>0 414 700 002</b>	<b>0 986 441 002</b>	
			Mot.Nr. 13741→	08.03-03.06		<b>0 414 700 003</b>	<b>0 986 441 012</b>	
31, 33, 36	7,8	228/243/265	F2BE3681A*...; F2BE3681B*...; F2BE3681C*...	04.06→		<b>0 414 700 006</b>		
40	10,3	294	F3AE0681...*	08.02-03.06		<b>0 414 701 006</b>	<b>0 986 441 003</b>	
42, 45	10,3	309/331	F3AE3681A*...; F3AE3681D*...	04.06→		<b>0 414 703 008</b>	<b>0 986 441 026</b>	
43	10,5	316	F3AE0681D*...	08.02→	TW	<b>0 414 701 006</b>	<b>0 986 441 003</b>	
						<b>0 414 703 008</b>	<b>0 986 441 026</b>	
48	13,0	353	F3BE0681E*...	08.02-03.06		<b>0 414 701 013</b>	<b>0 986 441 013</b>	
50	12,9	368	F3BE3681B*...	04.06→		<b>0 414 703 004</b>	<b>0 986 441 025</b>	
<b>260 S 27, 30, 31</b>	7,8	200/218/228	F2BE0681B*B...-Euro3; F2BE0681E...; F2BE0681F...					
			Mot.Nr. →13740	08.03-03.06		<b>0 414 700 002</b>	<b>0 986 441 002</b>	
			Mot.Nr. 13741→	08.03-03.06		<b>0 414 700 003</b>	<b>0 986 441 012</b>	
31, 33, 36	7,8	228/243/265	F2BE3681A*...; F2BE3681B*...; F2BE3681C*...	04.06→		<b>0 414 700 006</b>		
35	7,8	259	F2BE0681A*...	08.03-03.06	TW	<b>0 414 700 002</b>	<b>0 986 441 002</b>	
						<b>0 414 700 003</b>	<b>0 986 441 012</b>	
						<b>0 414 700 006</b>		
40	10,3	294	F3AE0681...	08.02-03.06		<b>0 414 701 006</b>	<b>0 986 441 003</b>	
42 Cube, 45 Cube [07]	10,3	309/331	F3AE3681A*...; F3AE3681D*...	04.07→		<b>0 414 703 008</b>	<b>0 986 441 026</b>	
42, 45	10,3	309/331	F3AE3681A*...; F3AE3681D*...	04.06→		<b>0 414 703 008</b>	<b>0 986 441 026</b>	
43	10,5	316	F3AE0681D*...	08.02-03.06	TW	<b>0 414 701 006</b>	<b>0 986 441 003</b>	
						<b>0 414 703 009</b>	<b>0 986 441 027</b>	
44, 48, 54	13,0	324/353/397	F3BE0681A*...; F3BE0681C*B...; F3BE0681E*...	08.02-03.06		<b>0 414 701 013</b>	<b>0 986 441 013</b>	
50	12,9	368	F3BE3681B*...	04.06→		<b>0 414 703 004</b>	<b>0 986 441 025</b>	
56	12,9	412	F3BE3681A*...	04.06-05.09		<b>0 414 703 008</b>	<b>0 986 441 026</b>	
<b>400 S 56</b>	12,9	412	F3BE3681A*...	04.06→		<b>0 414 703 004</b>	<b>0 986 441 025</b>	





◀ IVECO

<b>440 S</b> 31, 35	7,8	228/259	F2BE0681A*... <Euro 3>; F2BE0681B*...						
			Mot.Nr. →13740	08.03→		<b>0 414 700 002</b>	<b>0 986 441 002</b>		
			Mot.Nr. 13741→	08.03→		<b>0 414 700 003</b>	<b>0 986 441 012</b>		
33, 36	7,8	243/265	F2BE3681A*...; F2BE3681B*M...	04.06→		<b>0 414 700 006</b>			
40	10,3	294	F3AE0681...	08.02-03.06		<b>0 414 701 006</b>	<b>0 986 441 003</b>		
42, 45	10,3	309/331	F3AE3681A*...; F3AE3681D*...	04.06→		<b>0 414 703 008</b>	<b>0 986 441 026</b>		
43	10,5	316	F3AE0681D*...	08.02→	TW	<b>0 414 701 006</b>	<b>0 986 441 003</b>		
						<b>0 414 703 009</b>	<b>0 986 441 027</b>		
44, 48, 54	13,0	324/353/ 397	F3BE0681A*...; F3BE0681C*...; F3BE0681E*...	08.02→		<b>0 414 701 013</b>	<b>0 986 441 013</b>		
50	12,9	368	F3BE3681B*...	04.06→		<b>0 414 703 004</b>	<b>0 986 441 025</b>		
56	12,9	412	F3BE3681A*...	04.06→		<b>0 414 703 008</b>	<b>0 986 441 026</b>		
<b>Trakker</b>									
<b>N 190 T</b> 31, 33, 36 [07]	7,8	228/243/ 265	F2BE3681A*...; F2BE3681B*...; F2BE3681C*...	07.07→		<b>0 414 700 006</b>			
41, 45 [07]	13,0	302/331	F3BE3681C*...; F3BE3681D*...	07.07→		<b>0 414 703 004</b>	<b>0 986 441 025</b>		
<b>N 260 T</b> 33, 36 [07]	7,8	243/265	F2BE3681A*...; F2BE3681B*...	07.07→		<b>0 414 700 006</b>			
41, 45, 50 [07]	13,0	302/331/ 368	F3BE3681B*...; F3BE3681C*...; F3BE3681D*...	07.07→		<b>0 414 703 004</b>	<b>0 986 441 025</b>		
<b>N 340 T</b> 36 [07]	7,8	265	F2BE3681A*...	07.07→		<b>0 414 700 006</b>			
41, 45 [07]	13,0	302/331	F3BE3681C*...; F3BE3681D*...	07.07→		<b>0 414 703 004</b>	<b>0 986 441 025</b>		
<b>N 380 T</b> 41, 45, 50 [07]	13,0	302/331/ 368	F3BE3681B*...; F3BE3681C*...; F3BE3681D*...	07.07→		<b>0 414 703 004</b>	<b>0 986 441 025</b>		
<b>N 400 T</b> 36 [07]	7,8	265	F2BE3681A*...	07.07→		<b>0 414 700 006</b>			
41, 45, 50 [07]	13,0	302/331/ 368	F3BE3681B*...; F3BE3681C*...; F3BE3681D*...	07.07→		<b>0 414 703 004</b>	<b>0 986 441 025</b>		
<b>N 410 T</b> 41, 45, 50 [07]	13,0	302/331/ 368	F3BE3681B*...; F3BE3681C*...; F3BE3681D*...	07.07→		<b>0 414 703 004</b>	<b>0 986 441 025</b>		
<b>N 440 T</b> 41, 45, 50 [07]	13,0	302/331/ 368	F3BE3681B*...; F3BE3681C*...; F3BE3681D*...	07.07→		<b>0 414 703 004</b>	<b>0 986 441 025</b>		
<b>N 720 T</b> 41, 45, 50 [07]	13,0	302/331/ 368	F3BE3681B*...; F3BE3681C*...; F3BE3681D*...	07.07→		<b>0 414 703 004</b>	<b>0 986 441 025</b>		
<b>180 T</b> 24, 27, 31	7,8	180/200/ 228	F2BE0681B*B...; F2BE0681D...; F2BE0681F*B...						
			Mot.Nr. →13740	09.04-03.06		<b>0 414 700 002</b>	<b>0 986 441 002</b>		
			Mot.Nr. 13741→	09.04-03.06		<b>0 414 700 003</b>	<b>0 986 441 012</b>		
<b>190 T</b> 27, 31, 35	7,8	200/228/ 259	F2BE0681A*B...; F2BE0681B*B...; F2BE0681F*B...						
			Mot.Nr. →13740	09.04-09.06		<b>0 414 700 002</b>	<b>0 986 441 002</b>		
			Mot.Nr. 13741→	09.04-09.06		<b>0 414 700 003</b>	<b>0 986 441 012</b>		
31, 33, 36	7,8	228/243/ 265	F2BE3681A*...; F2BE3681B*...; F2BE3681C*...	04.06→		<b>0 414 700 006</b>			
38, 41, 45	13,0	280/302/ 331	F3BE3681C*...; F3BE3681D*...	04.05→		<b>0 414 703 004</b>	<b>0 986 441 025</b>		
38, 44	13,0	280/324	F3BE0681C*...; F3BE0681G*...	09.04→		<b>0 414 701 013</b>	<b>0 986 441 013</b>		
<b>260 T</b> 31, 35	7,8	228/259	F2BE0681A*B...; F2BE0681B*B...						
			Mot.Nr. →13740	09.04-03.06		<b>0 414 700 002</b>	<b>0 986 441 002</b>		
			Mot.Nr. 13741→	09.04-03.06		<b>0 414 700 003</b>	<b>0 986 441 012</b>		
33, 36	7,8	243/265	F2BE3681A*...; F2BE3681B*...	04.06→		<b>0 414 700 006</b>			
38, 44, 48	13,0	280/324/ 353	F3BE0681C*B...; F3BE0681E*B...; F3BE0681G*B...	09.04→		<b>0 414 701 013</b>	<b>0 986 441 013</b>		
41, 45, 50	13,0	302/331/ 368	F3BE3681B*...; F3BE3681C*...; F3BE3681D*...	04.06→		<b>0 414 703 004</b>	<b>0 986 441 025</b>		
<b>340 T</b> 35	7,8	259	F2BE0681A*B...						
			Mot.Nr. →13740	09.04-03.06		<b>0 414 700 002</b>	<b>0 986 441 002</b>		
			Mot.Nr. 13741→	09.04-03.06		<b>0 414 700 003</b>	<b>0 986 441 012</b>		
36	7,8	265	F2BE3681A*...	04.06→		<b>0 414 700 006</b>			
38, 44	13,0	280/324	F3BE0681C*B...; F3BE0681G*B...	09.04-03.06		<b>0 414 701 013</b>	<b>0 986 441 013</b>		
41, 45	13,0	302/331	F3BE3681C*...; F3BE3681D*...	04.06→		<b>0 414 703 004</b>	<b>0 986 441 025</b>		
<b>380 T</b> 35	7,8	259	F2BE0681A*B...						
			Mot.Nr. →13740	09.04-03.06		<b>0 414 700 002</b>	<b>0 986 441 002</b>		
			Mot.Nr. 13741→	09.04-03.06		<b>0 414 700 003</b>	<b>0 986 441 012</b>		
36	7,8	265	F2BE3681A*...	04.06→		<b>0 414 700 006</b>			
38, 48	13,0	280/353	F3BE0681E*B...; F3BE0681G*...	09.04→		<b>0 414 701 013</b>	<b>0 986 441 013</b>		





<b>380 T</b>	41, 45, 50	13,0	302/331/368	F3BE3681B*...; F3BE3681C*...; F3BE3681D*...	04.06→		<b>0 414 703 004</b>	<b>0 986 441 025</b>
	42	13,0	309	F3BE0681V*...	04.06→	TW	<b>0 414 701 013</b>	<b>0 986 441 013</b>
	44	13,0	324	F3BE0681C*B...	09.04→	TW	<b>0 414 703 004</b>	<b>0 986 441 025</b>
<b>400 T</b>	35	7,8	259	F2BE0681A*B... Mot.Nr. →13740 Mot.Nr. 13741→	09.04-03.06 09.04-03.06		<b>0 414 700 002</b>	<b>0 986 441 002</b>
	36	7,8	265	F2BE3681A*...	04.06→		<b>0 414 700 006</b>	
	38	13,0	280	F3BE0681G*...	09.04→	TW	<b>0 414 701 013</b>	<b>0 986 441 013</b>
	41, 50	13,0	302/368	F3BE3681B*...; F3BE3681D*...	04.06→		<b>0 414 703 004</b>	<b>0 986 441 025</b>
	42	13,0	309	F3BE0681V*...	04.06→		<b>0 414 701 013</b>	<b>0 986 441 013</b>
	44	13,0	324	F3BE0681C*B...	09.04-03.06		<b>0 414 701 013</b>	<b>0 986 441 013</b>
<b>410 T</b>	35	7,8	259	F2BE0681A*B... Mot.Nr. →13740 Mot.Nr. 13741→	09.04-03.06 09.04-03.06		<b>0 414 700 002</b>	<b>0 986 441 002</b>
	36	7,8	265	F2BE3681A*...	04.06→		<b>0 414 700 006</b>	
	38	13,0	280	F3BE0681G*B...	09.04→	TW	<b>0 414 701 013</b>	<b>0 986 441 013</b>
	41, 45, 50	13,0	302/331/368	F3BE3681B*...; F3BE3681C*...; F3BE3681D*...	04.06→		<b>0 414 703 004</b>	<b>0 986 441 025</b>
	42	13,0	309	F3BE0681V*...	04.06→		<b>0 414 701 013</b>	<b>0 986 441 013</b>
	44	13,0	324	F3BE0681C*B...	09.04→	TW	<b>0 414 701 013</b>	<b>0 986 441 013</b>
	48	13,0	353	F3BE0681E*B...	09.04-03.06		<b>0 414 701 013</b>	<b>0 986 441 013</b>
<b>440 T</b>	38, 44	13,0	280/324	F3BE0681C*B...; F3BE0681G*B...	09.04→		<b>0 414 701 013</b>	<b>0 986 441 013</b>
	41, 45, 50	13,0	302/331/368	F3BE3681B*...; F3BE3681C*...; F3BE3681D*...	04.06→		<b>0 414 703 004</b>	<b>0 986 441 025</b>
<b>720 T</b>	38, 44, 48	13,0	280/324/353	F3BE0681C*B...; F3BE0681E*B...; F3BE0681G*...	09.04→		<b>0 414 701 013</b>	<b>0 986 441 013</b>
	41, 45, 50	13,0	302/331/368	F3BE3681B*...; F3BE3681C*...; F3BE3681D*...	04.06→		<b>0 414 703 004</b>	<b>0 986 441 025</b>
	42	13,0	309	F3BE0681V*...	04.06→	TW	<b>0 414 701 013</b>	<b>0 986 441 013</b>
							<b>0 414 703 004</b>	<b>0 986 441 025</b>

**SCANIA**

<b>G</b>									
<b>230</b>		8,9	169	DC 9.13 <Euro 3>	09.07→		<b>0 414 701 036</b>		
				DC 9.16 <Euro 4>	09.07→		<b>0 414 701 042</b>		
<b>270</b>		8,9	198	DC 9.12 <Euro 3>	09.07→		<b>0 414 701 036</b>		
				DC 9.17 <Euro 4>	09.07→		<b>0 414 701 037</b>		
<b>310</b>		8,9	228	DC 9.11 <Euro 3>	09.07→		<b>0 414 701 036</b>		
				DC 9.18 <Euro 4>	09.07→		<b>0 414 701 037</b>		
<b>340</b>		10,6	250	DC 11.08 <Euro 3>					
				Mot.Type L01	09.07→		<b>0 414 701 019</b>	<b>0 986 441 015</b>	
				Mot.Type L02	09.07→		<b>0 414 701 045</b>		
<b>380</b>		11,0	280	DC 11.09 <Euro 3>	09.07→		<b>0 414 701 019</b>	<b>0 986 441 015</b>	
		12,0	280	DC 12.17 <Euro 3>	09.08→		<b>0 414 701 044</b>		
<b>420</b>		12,0	309	DC 12.06 <Euro 3>	09.07→		<b>0 414 701 044</b>		
<b>P</b>									
<b>230</b>		8,9	169	DC 9.13 <Euro 3>	09.04→		<b>0 414 701 036</b>		
				DC 9.16 <Euro 4>	09.05→		<b>0 414 701 042</b>		
<b>270</b>		8,9	198	DC 9.12 <Euro 3>	09.04→		<b>0 414 701 036</b>		
				DC 9.17 <Euro 4>	09.05→		<b>0 414 701 037</b>		
<b>310</b>		8,9	228	DC 9.11 <Euro 3>	09.04→		<b>0 414 701 036</b>		
				DC 9.18 <Euro 4>	09.05→		<b>0 414 701 037</b>		
<b>340</b>		10,6	250	DC 11.08 <Euro 3>					
				Mot.Type L01	09.04→		<b>0 414 701 019</b>	<b>0 986 441 015</b>	
				Mot.Type L02	09.04→		<b>0 414 701 045</b>		





◀ SCANIA

<b>380</b>	11,0	280	DC 11.09 <Euro 3>	09.04→	<b>0 414 701 019</b>	<b>0 986 441 015</b>
	12,0	280	DC 12.17 <Euro 3>	09.07→	<b>0 414 701 044</b>	
<b>420</b>	12,0	309	DC 12.06 <Euro 3>	09.07→	<b>0 414 701 044</b>	
<b>R</b>						
<b>230</b>	8,9	169	DC 9.13 <Euro 3>	09.04→	<b>0 414 701 036</b>	
			DC 9.16 <Euro 4>	09.05→	<b>0 414 701 042</b>	
<b>270</b>	8,9	198	DC 9.12 <Euro 3>	09.04→	<b>0 414 701 036</b>	
			DC 9.17 <Euro 4>	09.05→	<b>0 414 701 037</b>	
<b>310</b>	8,9	228	DC 9.11 <Euro 3>	09.04→	<b>0 414 701 036</b>	
			DC 9.18 <Euro 4>	09.05→	<b>0 414 701 037</b>	
<b>340</b>	10,6	250	DC 11.08 <Euro 3>			
			Mot. Typ L01	03.04→	<b>0 414 701 019</b>	<b>0 986 441 015</b>
			Mot. Typ L02	03.04→	<b>0 414 701 045</b>	
<b>380</b>	11,0	280	DC 11.09 <Euro 3>	03.04→	<b>0 414 701 019</b>	<b>0 986 441 015</b>
<b>420</b>	12,0	309	DC 12.06 <Euro 3>	09.07→	<b>0 414 701 044</b>	
<b>500</b>	16,0	368	DC 16.04 <Euro 3>	03.04→	<b>0 414 701 020</b>	<b>0 986 441 016</b>
			DC 16.06 <Euro 4>; DC 16.09 <Euro 5>; DC 16.19 <Euro 5>	02.06→	<b>0 414 701 038</b>	
<b>560</b>	16,0	412	DC 16.05 <Euro 4>; DC 16.18 <Euro 5>	02.06→	<b>0 414 701 040</b>	
<b>580</b>	16,0	426	DC 16.03 <Euro 3>	04.04→	<b>0 414 701 020</b>	<b>0 986 441 016</b>
<b>620</b>	16,0	456	DC 16.08 <Euro 4>; DC 16.17 <Euro 5>	02.06→	<b>0 414 701 040</b>	
<b>Serie 114</b>						
<b>K EB, IB [BUS]</b>	10,6	250	DC 11.06 <Euro 3>			
			Mot.Nr. →6173205 SSS	08.97→	<b>0 414 701 016</b>	
			Mot.Nr. 6173206 SSS→	08.97→	<b>0 414 701 018</b>	
			250/280 DC 11.03 <Euro 3>; DC 11.04 <Euro 3>			
			Mot.Nr. →6173205 SSS	08.97→	<b>0 414 701 008</b>	<b>0 986 441 008</b>
			Mot.Nr. 6173206 SSS→	08.97→	<b>0 414 701 019</b>	<b>0 986 441 015</b>
<b>P,R 340</b>	10,6	250	DC 11.06 <Euro 3>			
			Mot.Nr. →6173205 SSS	02.96-09.04	<b>0 414 701 016</b>	
			Mot.Nr. 6173206 SSS→	02.96-09.04	<b>0 414 701 018</b>	
			340, 380 DC 11.01 <Euro 2>; DC 11.02 <Euro 2>			
			Mot.Nr. →6173205 SSS	03.96-02.02	<b>0 414 701 005</b>	<b>0 986 441 001</b>
			Mot.Nr. 6173206 SSS→	03.96-02.02	<b>0 414 701 017</b>	<b>0 986 441 014</b>
			DC 11.03 <Euro 3>; DC 11.04 <Euro 3>			
			Mot.Nr. →6173205 SSS	02.96-09.04	<b>0 414 701 008</b>	<b>0 986 441 008</b>
			Mot.Nr. 6173206 SSS→	02.96-09.04	<b>0 414 701 019</b>	<b>0 986 441 015</b>
<b>T 340</b>	10,6	250	DC 11.06 <Euro 3>			
			Mot.Nr. →6173205 SSS	02.96-09.04	<b>0 414 701 016</b>	
			Mot.Nr. 6173206 SSS→	02.96-09.04	<b>0 414 701 018</b>	
			340, 380 DC 11.01 <Euro 2>; DC 11.02 <Euro 2>			
			Mot.Nr. →6173205 SSS	03.96-02.02	<b>0 414 701 005</b>	<b>0 986 441 001</b>
			Mot.Nr. 6173206 SSS→	03.96-02.02	<b>0 414 701 017</b>	<b>0 986 441 014</b>
			DC 11.03 <Euro 3>; DC 11.04 <Euro 3>			
			Mot.Nr. →6173205 SSS	02.96-09.04	<b>0 414 701 008</b>	<b>0 986 441 008</b>
			Mot.Nr. 6173206 SSS→	02.96-09.04	<b>0 414 701 019</b>	<b>0 986 441 015</b>
<b>Serie 124</b>						
<b>K EB [BUS]</b>	11,7	309	DC 12.01 <Euro 3>			
			Mot.Nr. →6173205 SSS	10.97-08.02	<b>0 414 701 007</b>	<b>0 986 441 007</b>
			Mot.Nr. 6173206 SSS→	10.97-08.02	<b>0 414 701 020</b>	<b>0 986 441 016</b>
<b>EB, IB [BUS]</b>	12,0	309	DSC 12.05 <Euro 2>			
			Mot.Nr. →6173205 SSS	08.97-02.02	<b>0 414 701 005</b>	<b>0 986 441 001</b>
			Mot.Nr. 6173206 SSS→	08.97-02.02	<b>0 414 701 017</b>	<b>0 986 441 014</b>
<b>IB [BUS]</b>	12,0	294	DC 12.02 <Euro 3>			
			Mot.Nr. →6173205 SSS	08.97→	<b>0 414 701 008</b>	<b>0 986 441 008</b>
			Mot.Nr. 6173206 SSS→	08.97→	<b>0 414 701 019</b>	<b>0 986 441 015</b>
			309 DC 12.01 <Euro 3>			
			Mot.Nr. →6173205 SSS	08.97-08.02	<b>0 414 701 007</b>	<b>0 986 441 007</b>
			Mot.Nr. 6173206 SSS→	08.97-08.02	<b>0 414 701 020</b>	<b>0 986 441 016</b>





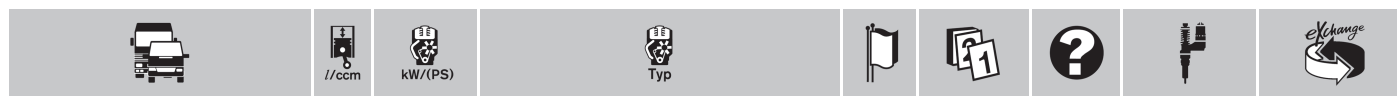

<b>P,R</b> 360	12,0	265	DC 12.02 <Euro 3>	09.95-09.04	<b>0 414 701 008</b>	<b>0 986 441 008</b>
420	12,0	309	DC 12.01 <Euro 3>			
			Mot.Nr. →6173205 SSS	09.95-08.02	<b>0 414 701 007</b>	<b>0 986 441 007</b>
			Mot.Nr. 6173206 SSS→	09.95-08.02	<b>0 414 701 020</b>	<b>0 986 441 016</b>
			DSC 12.05 <Euro 2>			
			Mot.Nr. →6173205 SSS	09.95-02.02	<b>0 414 701 005</b>	<b>0 986 441 001</b>
			Mot.Nr. 6173206 SSS→	09.95-02.02	<b>0 414 701 017</b>	<b>0 986 441 014</b>
<b>T</b> 400, 420	12,0	294/309	DC 12.02 <Euro 3>	09.95-09.04	<b>0 414 701 008</b>	<b>0 986 441 008</b>
420	12,0	309	DC 12.01 <Euro 3>			
			Mot.Nr. →6173205 SSS	09.95-08.02	<b>0 414 701 007</b>	<b>0 986 441 007</b>
			Mot.Nr. 6173206 SSS→	09.95-08.02	<b>0 414 701 020</b>	<b>0 986 441 016</b>
			DSC 12.03	06.96-02.02	<b>0 414 701 005</b>	<b>0 986 441 001</b>
			DSC 12.05 <Euro 2>			
			Mot.Nr. →6173205 SSS	09.95-02.02	<b>0 414 701 005</b>	<b>0 986 441 001</b>
			Mot.Nr. 6173206 SSS→	09.95-02.02	<b>0 414 701 017</b>	<b>0 986 441 014</b>

**Serie 164**

<b>R</b> 480	16,0	353	DC 16.02 <Euro 3>			
			Mot.Nr. →6173205 SSS	04.00-05.04	<b>0 414 701 008</b>	<b>0 986 441 008</b>
			Mot.Nr. 6173206 SSS→	04.00-05.04	<b>0 414 701 019</b>	<b>0 986 441 015</b>
580	16,0	427	DC 16.01 <Euro 3>			
			Mot.Nr. →6173205 SSS	04.00-05.04	<b>0 414 701 007</b>	<b>0 986 441 007</b>
			Mot.Nr. 6173206 SSS→	04.00-05.04	<b>0 414 701 020</b>	<b>0 986 441 016</b>
<b>T</b> 480	16,0	353	DC 16.02 <Euro 3>			
			Mot.Nr. →6173205 SSS	04.00-09.04	<b>0 414 701 008</b>	<b>0 986 441 008</b>
			Mot.Nr. 6173206 SSS→	04.00-09.04	<b>0 414 701 019</b>	<b>0 986 441 015</b>
580	16,0	427	DC 16.01 <Euro 3>			
			Mot.Nr. →6173205 SSS	04.00-09.04	<b>0 414 701 007</b>	<b>0 986 441 007</b>
			Mot.Nr. 6173206 SSS→	04.00-09.04	<b>0 414 701 020</b>	<b>0 986 441 016</b>

**T**

<b>340</b>	10,6	250	DC 11.08 <Euro 3>			
			Mot. Typ L01	09.04-10.05	<b>0 414 701 019</b>	<b>0 986 441 015</b>
			Mot. Typ L02	09.04-10.05	<b>0 414 701 045</b>	
<b>380</b>	11,0	280	DC 11.09 <Euro 3>	09.04-10.05	<b>0 414 701 019</b>	<b>0 986 441 015</b>
<b>500</b>	16,0	368	DC 16.04 <Euro 3>	09.04-10.05	<b>0 414 701 020</b>	<b>0 986 441 016</b>
<b>580</b>	16,0	426	DC 16.03 <Euro 3>	09.04-10.05	<b>0 414 701 020</b>	<b>0 986 441 016</b>

**VOLVO****B**

<b>12</b> CH 5000-	12,0	250/272/ 279/305/ 309	D12A340 <Euro 2>; D12A370 <Euro 2>; D12A380 <Euro 2>; D12A415 <Euro 2>; D12A420 <Euro 2>			
			Mot.Nr. →93097	10.95-12.00 TW	<b>0 414 701 004</b>	<b>0 986 441 004</b>
			Mot.Nr. 93098→	10.95-12.00 TW	<b>0 414 702 002</b>	

**FH**

<b>12</b> 340, 380	12,0	250/279	D 12C340 <Euro 2>; D 12C380 <Euro 2>	08.98-08.02	BO,TW	<b>0 414 702 006</b>	<b>0 986 441 110</b>
	12,1	250/280	D 12D340; D 12D380	12.01-08.06	BO	<b>0 414 702 007</b>	<b>0 986 441 011</b>
340, 380, 420	12,0	250/279/ 309	D 12A340 <Euro 2>; D 12A380 <Euro 2>; D 12A420 <Euro 2>				
			Mot.Nr. →93097	08.93-08.98	BO	<b>0 414 701 004</b>	<b>0 986 441 004</b>
			Mot.Nr. 93098→	08.93-08.98	BO	<b>0 414 702 002</b>	
420	12,0	309	D 12C420 <Euro 2>	08.98-08.02	BO,TW	<b>0 414 702 006</b>	<b>0 986 441 110</b>
						<b>0 414 702 010</b>	<b>0 986 441 006</b>
	12,1	309	D 12D420	12.01-08.06	BO,E96	<b>0 414 702 010</b>	<b>0 986 441 006</b>
460	12,0	338	D 12C460 <Euro 2>	08.98-08.02	BO,TW	<b>0 414 702 010</b>	<b>0 986 441 006</b>

**FL**

<b>12</b> 380, 420	12,0	279/309	D12A380 <Euro 2>; D12A420 <Euro 2>				
			Mot.Nr. →93097	09.95-12.01	BO	<b>0 414 701 004</b>	<b>0 986 441 004</b>
			Mot.Nr. 93098→	09.95-12.01	BO	<b>0 414 702 002</b>	





◀ VOLVO

FM							
12 340, 380	12,1	250/279	D 12C340; D 12C380	09.98-01.02	BO,EC9	<b>0 414 702 006</b>	<b>0 986 441 110</b>
					BO,EU2	<b>0 414 702 010</b>	<b>0 986 441 006</b>
		250/280	D 12D340; D 12D380	01.02-09.05	EU2	<b>0 414 702 010</b>	<b>0 986 441 006</b>
					EU3	<b>0 414 702 007</b>	<b>0 986 441 011</b>
420	12,1	309	D 12C420	09.98-01.02	BO,EU2	<b>0 414 702 010</b>	<b>0 986 441 006</b>
					BO,TW	<b>0 414 702 007</b>	<b>0 986 441 011</b>
420, 460	12,1	309/339	D 12D420; D 12D460	01.02-09.05	EU2	<b>0 414 702 010</b>	<b>0 986 441 006</b>
425	12,1	313	D 12C425	11.02-09.05	BO,E96	<b>0 414 702 010</b>	<b>0 986 441 006</b>

**VW (VOLKSWAGEN)**

California T5							
1.9 TDI [7H]	1,9	62/75	BRR; BRS	01.06-11.09		<b>0 414 720 363</b>	<b>0 986 441 568</b>
		63/77	AXB; AXC		04.03-11.09		<b>0 986 441 559</b>
2.5 TDI, TDI 4 Motion [7H]	2,5	96	AXD	02.03-11.09		<b>0 414 720 260</b>	<b>0 986 441 561</b>
			BNZ	01.06-11.09		<b>0 414 720 360</b>	<b>0 986 441 579</b>
		120/128	AXE; BLJ				
			Fg.Nr. →7H..5H042 663 →7H..5X010 640	02.03-10.04		<b>0 414 720 260</b>	<b>0 986 441 561</b>
	Fg.Nr. 7H..5H042 664 →7H..5X010 641→	11.04-11.09		<b>0 414 720 278</b>	<b>0 986 441 573</b>		
	128	BPC		01.06-11.09		<b>0 414 720 359</b>	<b>0 986 441 578</b>
Caravelle T5							
1.9 TDI [7H]	1,9	62/75	BRR; BRS	01.06-11.09		<b>0 414 720 363</b>	<b>0 986 441 568</b>
		63/77	AXB; AXC		04.03-11.09		<b>0 986 441 559</b>
2.5 TDI, TDI 4 Motion [7H]	2,5	96	AXD	02.03-11.09		<b>0 414 720 260</b>	<b>0 986 441 561</b>
			BNZ	01.06-11.09		<b>0 414 720 360</b>	<b>0 986 441 579</b>
		120/128	AXE; BLJ				
			Fg.Nr. →7H..5H042 663 →7H..5X010 640	02.03-10.04		<b>0 414 720 260</b>	<b>0 986 441 561</b>
	Fg.Nr. 7H..5H042 664 →7H..5X010 641→	11.04-11.09		<b>0 414 720 278</b>	<b>0 986 441 573</b>		
	128	BPC		01.06-11.09		<b>0 414 720 359</b>	<b>0 986 441 578</b>
Multivan T5							
1.9 TDI [7H]	1,9	62/75	BRR; BRS	01.06-11.09		<b>0 414 720 363</b>	<b>0 986 441 568</b>
		63/77	AXB; AXC		04.03-11.09		<b>0 986 441 559</b>
2.5 TDI, TDI 4 Motion [7H]	2,5	96	AXD	02.03-11.09		<b>0 414 720 260</b>	<b>0 986 441 561</b>
			BNZ	01.06-11.09		<b>0 414 720 360</b>	<b>0 986 441 579</b>
		120/128	AXE; BLJ				
			Fg.Nr. →7H..5H042 663 →7H..5X010 640	02.03-10.04		<b>0 414 720 260</b>	<b>0 986 441 561</b>
	Fg.Nr. 7H..5H042 664 →7H..5X010 641→	11.04-11.09		<b>0 414 720 278</b>	<b>0 986 441 573</b>		
	128	BPC		01.06-11.09		<b>0 414 720 359</b>	<b>0 986 441 578</b>
Transporter T5							
1.9 TDI [7H]	1,9	62/75	BRR; BRS	01.06-11.09		<b>0 414 720 363</b>	<b>0 986 441 568</b>
		63/77	AXB; AXC		04.03-11.09		<b>0 986 441 559</b>
TDI [7J]	1,9	62/75	BRR; BRS	06.06-11.09		<b>0 414 720 363</b>	<b>0 986 441 568</b>
		63/77	AXB; AXC		04.03-11.09		<b>0 986 441 559</b>
2.5 TDI, TDI 4 Motion [7H]	2,5	96	AXD	02.03-11.09		<b>0 414 720 260</b>	<b>0 986 441 561</b>
			BNZ	01.06-11.09		<b>0 414 720 360</b>	<b>0 986 441 579</b>
		120/128	AXE; BLJ				
			Fg.Nr. →7H..5H042 663 →7H..5X010 640	02.03-10.04		<b>0 414 720 260</b>	<b>0 986 441 561</b>
	Fg.Nr. 7H..5H042 664 →7H..5X010 641→	11.04-11.09		<b>0 414 720 278</b>	<b>0 986 441 573</b>		
	128	BPC		01.06-11.09		<b>0 414 720 359</b>	<b>0 986 441 578</b>
TDI, TDI 4 Motion [7J]	2,5	96	AXD	04.03-11.09		<b>0 414 720 260</b>	<b>0 986 441 561</b>
			BNZ	06.06-11.09		<b>0 414 720 360</b>	<b>0 986 441 579</b>
		128	AXE				
			Fg.Nr. →7H..5H042 663 →7H..5X010 640	01.04-10.04		<b>0 414 720 260</b>	<b>0 986 441 561</b>
	Fg.Nr. 7H..5H042 664 →7H..5X010 641→	11.04-11.09		<b>0 414 720 278</b>	<b>0 986 441 573</b>		
		BPC		06.06-11.09		<b>0 414 720 359</b>	<b>0 986 441 578</b>





**DAF**

<b>CF</b>							
75 .250	9,2	183	PE 183 <Euro3>		12.99-06.02		<b>0 414 755 005</b>
					02.01-02.07	MEB	<b>0 414 755 008</b>
.290	9,2	212	PE 212 <Euro3>		11.99-02.02		<b>0 414 755 005</b>
.310	9,2	228	PE 228 <Euro3>		02.01-07.07	MEB	<b>0 414 755 008</b>
.320	9,2	235	PE 235 <Euro3>		01.99-01.02		<b>0 414 755 005</b>
.360	9,2	265	PE 265 <Euro3>		02.01-05.07		<b>0 414 755 008</b>
85 .340, .380, .430	12,6	250/280/	XE 250 <Euro 3>; XE 280 <Euro 3>; XE 315 <Euro 3>		07.99-02.02		<b>0 414 755 005</b>
		315				01.01-01.08	
.480	12,6	355	XE 355 <Euro 3>		10.01-10.07		<b>0 414 755 008</b>
<b>XF</b>							
95 .380	12,6	280	XE 280 C <Euro 3>		04.98-04.03	TW	<b>0 414 755 005</b>
			XE 280 <Euro 3>		02.02-01.07		<b>0 414 755 008</b>
.430	12,6	315	XE 315 C <Euro 3>		01.99-08.03		<b>0 414 755 005</b>
.430, .460	12,6	315/335	XE 315 <Euro 3>; XE 335 <Euro 3>		01.02-12.07		<b>0 414 755 008</b>
.480	12,6	355	XE 355 C <Euro 3>		05.98-09.03	TW	<b>0 414 755 005</b>
							<b>0 414 755 008</b>
			XE 355 <Euro 3>		02.02-12.07		<b>0 414 755 008</b>
.530	12,6	390	XE 390 C <Euro 3>		11.99-09.03		<b>0 414 755 005</b>
					11.01-01.07		<b>0 414 755 008</b>

**KAVZ KURGAN**

<b>Serie 4000</b>							
4239	7,1	162	BF6M 1013-22E3 <Euro 3>		09.08→		<b>0 414 750 004</b>

**LAZ**

<b>A152D</b>							
4.8	4,8	140	BF4M 1013FC <Euro 3>		01.08→		<b>0 414 750 004</b>

**MAZ MINSK**

<b>Serie 100</b>							
105	6,4	205	OM 906 LA <Euro 3>				
			Komp.Nr. 505012/05		01.02→	TNK	<b>0 414 799 008</b>
			Komp.Nr. 505012/06				<b>0 986 445 103</b>
107	6,4	205	OM 906 LA <Euro 3>				
			Komp.Nr. 505012/05		01.02→	TNK	<b>0 414 799 008</b>
			Komp.Nr. 505012/06				<b>0 986 445 103</b>
<b>Serie 200</b>							
203	6,4	170/205	OM 906 LA <Euro 3>				
			Komp.Nr. 505012/05		01.02→	TNK	<b>0 414 799 008</b>
			Komp.Nr. 505012/06				<b>0 986 445 103</b>

**MERCEDES-BENZ**

<b>Actros</b>							
1831 , AK, L [SKN]	12,0	230	OM 541.920 <(501)LA Euro2>; OM 541.926 <(501)LA Euro2>				
			Komp.Nr. 505108 /01/02		09.96-09.03	TNK	<b>0 414 799 005</b>
							<b>0 986 445 102</b>
			Komp.Nr. 505108 /05/06		09.96-09.03	TNK	<b>0 414 799 015</b>





◀ MERCEDES-BENZ

<b>1831</b> AK, L [SKN]	11,9	230	OM 541.940 <(501)LA Euro3>; OM 541.941 <(501)LA Euro3>						
			Komp.Nr. 505108/01	09.96-09.03	TNK	<b>0 414 799 005</b>	<b>0 986 445 002</b>	<b>0 986 445 102</b>	
			Komp.Nr. 505108/05	09.96-09.03	TNK	<b>0 414 799 015</b>			
<b>1835</b> , AK [SKN]	11,9	260	OM 541.942 <(501)LA Euro3>; OM 541.943 <(501)LA Euro3>						
			Komp.Nr. 505108/01	09.96-09.03	TNK	<b>0 414 799 005</b>	<b>0 986 445 002</b>	<b>0 986 445 102</b>	
			Komp.Nr. 505108/05	09.96-09.03	TNK	<b>0 414 799 015</b>			
, AK, L [SKN]	12,0	260	OM 541.922 <(501)LA Euro2>; OM 541.927 <(501)LA Euro2>						
			Komp.Nr. 505108 /01/02	09.96-09.03	TNK	<b>0 414 799 005</b>	<b>0 986 445 002</b>	<b>0 986 445 102</b>	
			Komp.Nr. 505108 /05/06	09.96-09.03	TNK	<b>0 414 799 015</b>			
<b>1840</b> , AK [SKN]	11,9	290	OM 541.944 <(501)LA Euro3>; OM 541.945 <(501)LA Euro3>						
			Komp.Nr. 505108/01	09.96-09.03	TNK	<b>0 414 799 005</b>	<b>0 986 445 002</b>	<b>0 986 445 102</b>	
			Komp.Nr. 505108/05	09.96-09.03	TNK	<b>0 414 799 015</b>			
, AK, L [SKN]	12,0	290	OM 541.923 <(501)LA Euro2>; OM 541.924 <(501)LA Euro2>						
			Komp.Nr. 505108 /01/02	09.96-09.03	TNK	<b>0 414 799 005</b>	<b>0 986 445 002</b>	<b>0 986 445 102</b>	
			Komp.Nr. 505108 /05/06	09.96-09.03	TNK	<b>0 414 799 015</b>			
<b>1843</b> [SKN]	11,9	315	OM 541.946 <(501)LA Euro3>						
			Komp.Nr. 505108/01	09.96-09.03	TNK	<b>0 414 799 005</b>	<b>0 986 445 002</b>	<b>0 986 445 102</b>	
			Komp.Nr. 505108/05	09.96-09.03	TNK	<b>0 414 799 015</b>			
, L [SKN]	12,0	315	OM 541.925 <(501)LA Euro2>						
			Komp.Nr. 505108 /05/06	09.96-09.03	TNK	<b>0 414 799 015</b>			
			Komp.Nr. 505108/01	09.96-09.03	TNK	<b>0 414 799 005</b>	<b>0 986 445 002</b>	<b>0 986 445 102</b>	
AK [SKN]	12,0	315	OM 541.921 <(501)LA Euro2>						
			Komp.Nr. 505108 /01/02	04.97-09.03	TNK	<b>0 414 799 005</b>	<b>0 986 445 002</b>	<b>0 986 445 102</b>	
			Komp.Nr. 505108 /05/06	04.97-09.03	TNK	<b>0 414 799 015</b>			
<b>1848</b> , AK [SKN]	15,9	350	OM 542.940 <(502)LA Euro3>; OM 542.941 <(502)LA Euro3>						
			Komp.Nr. 505108 /01/02	09.96-09.03	TNK	<b>0 414 799 005</b>	<b>0 986 445 002</b>	<b>0 986 445 102</b>	
			Komp.Nr. 505108 /04	09.96-09.03	TNK	<b>0 414 799 007</b>			
			Komp.Nr. 505108 /06	09.96-09.03	TNK	<b>0 414 799 015</b>			
, L [SKN]	16,0	350	OM 542.921 <(502)LA Euro2>						
			Komp.Nr. 505108 /01/02	09.96-09.03	TNK	<b>0 414 799 005</b>	<b>0 986 445 002</b>	<b>0 986 445 102</b>	
AK [SKN]	16,0	350	OM 542.925 <(502)LA Euro2>						
				04.97-09.03		<b>0 414 799 005</b>	<b>0 986 445 002</b>	<b>0 986 445 102</b>	
<b>1853</b> , AK [SKN]	15,9	390	OM 542.942 <(502)LA Euro3>; OM 542.943 <(502)LA Euro2>						
			Komp.Nr. 505108 /01/02	09.96-09.03	TNK	<b>0 414 799 005</b>	<b>0 986 445 002</b>	<b>0 986 445 102</b>	
			Komp.Nr. 505108 /04	09.96-09.03	TNK	<b>0 414 799 007</b>			
			Komp.Nr. 505108 /06	09.96-09.03	TNK	<b>0 414 799 015</b>			
, L [SKN]	16,0	390	OM 542.920 <(502)LA Euro2>						
			Komp.Nr. 505108 /01/02	09.96-09.03	TNK	<b>0 414 799 005</b>	<b>0 986 445 002</b>	<b>0 986 445 102</b>	
<b>1857</b> L [SKN]	15,9	420	OM 542.944 <(502)LA Euro3>						
			Komp.Nr. 505108 /01/02	09.96-09.03	TNK	<b>0 414 799 005</b>	<b>0 986 445 002</b>	<b>0 986 445 102</b>	
			Komp.Nr. 505108 /04	09.96-09.03	TNK	<b>0 414 799 007</b>			
			Komp.Nr. 505108 /06	09.96-09.03	TNK	<b>0 414 799 015</b>			





<b>1857 L</b> [SKN]	16,0	420	OM 542.922 <(502)LA Euro2> Komp.Nr. 505108 /01/02	04.97-09.03	TNK	<b>0 414 799 005</b>	<b>0 986 445 002</b> <b>0 986 445 102</b>
<b>2031 , A</b> [SKN]	12,0	230	OM 541.920 <(501)LA Euro2>; OM 541.926 <(501)LA Euro2> Komp.Nr. 505108 /01/02	09.96-09.03	TNK	<b>0 414 799 005</b>	<b>0 986 445 002</b> <b>0 986 445 102</b>
			Komp.Nr. 505108 /05/06	09.96-09.03	TNK	<b>0 414 799 015</b>	
<b>, AK,AS</b> [SKN]	11,9	230	OM 541.940 <(501)LA Euro3>; OM 541.941 <(501)LA Euro3> Komp.Nr. 505108/01	09.96-09.03	TNK	<b>0 414 799 005</b>	<b>0 986 445 002</b> <b>0 986 445 102</b>
			Komp.Nr. 505108/05	09.96-09.03	TNK	<b>0 414 799 015</b>	
<b>2035</b> [SKN]	11,9	260	OM 541.942 <(501)LA Euro3> Komp.Nr. 505108/01	04.97-09.03	TNK	<b>0 414 799 005</b>	<b>0 986 445 002</b> <b>0 986 445 102</b>
			Komp.Nr. 505108/05	04.97-09.03	TNK	<b>0 414 799 015</b>	
	12,0	260	OM 541.927 <(501)LA Euro2> Komp.Nr. 505108 /01/02	04.97-09.03	TNK	<b>0 414 799 005</b>	<b>0 986 445 002</b> <b>0 986 445 102</b>
			Komp.Nr. 505108 /05/06	04.97-09.03	TNK	<b>0 414 799 015</b>	
<b>2040 , A</b> [SKN]	12,0	290	OM 541.923 <(501)LA Euro2>; OM 541.924 <(501)LA Euro2> Komp.Nr. 505108 /01/02	09.96-09.03	TNK	<b>0 414 799 005</b>	<b>0 986 445 002</b> <b>0 986 445 102</b>
			Komp.Nr. 505108 /05/06	09.96-09.03	TNK	<b>0 414 799 015</b>	
<b>, AK,AS</b> [SKN]	11,9	290	OM 541.944 <(501)LA Euro3>; OM 541.945 <(501)LA Euro3> Komp.Nr. 505108/01	11.97-09.03	TNK	<b>0 414 799 005</b>	<b>0 986 445 002</b> <b>0 986 445 102</b>
			Komp.Nr. 505108/05	11.97-09.03	TNK	<b>0 414 799 015</b>	
<b>2043 AS</b> [SKN]	11,9	315	OM 541.947 <(501)LA Euro3> Komp.Nr. 505108/01	09.98-09.03	TNK	<b>0 414 799 005</b>	<b>0 986 445 002</b> <b>0 986 445 102</b>
			Komp.Nr. 505108/05	09.98-09.03	TNK	<b>0 414 799 015</b>	
	12,0	315	OM 541.921 <(501)LA> Komp.Nr. 505108 /01/02	09.96-09.03	TNK	<b>0 414 799 005</b>	<b>0 986 445 002</b> <b>0 986 445 102</b>
			Komp.Nr. 505108 /05/06	09.96-09.03	TNK	<b>0 414 799 015</b>	
<b>2048 AS</b> [SKN]	15,9	350	OM 542.925 <(502)LA>	09.96-09.03		<b>0 414 799 005</b>	<b>0 986 445 002</b> <b>0 986 445 102</b>
			OM 542.941 <(502)LA Euro3> Komp.Nr. 505108 /01/02	09.96-09.03	TNK	<b>0 414 799 005</b>	<b>0 986 445 002</b> <b>0 986 445 102</b>
			Komp.Nr. 505108 /04	09.96-09.03	TNK	<b>0 414 799 007</b>	
			Komp.Nr. 505108 /06	09.96-09.03	TNK	<b>0 414 799 015</b>	
<b>2053</b> [SKN]	12,0	390	OM 542.920 <(501)LA Euro2> Komp.Nr. 505108 /01/02	09.96-09.03	TNK	<b>0 414 799 005</b>	<b>0 986 445 002</b> <b>0 986 445 102</b>
<b>2531</b> [SKN]	11,9	230	OM 541.940 <(501)LA Euro3> Komp.Nr. 505108/01	09.96-09.03	TNK	<b>0 414 799 005</b>	<b>0 986 445 002</b> <b>0 986 445 102</b>
			Komp.Nr. 505108/05	09.96-09.03	TNK	<b>0 414 799 015</b>	
<b>, L</b> [SKN]	12,0	230	OM 541.920 <(501)LA Euro2> Komp.Nr. 505108 /01/02	09.96-09.03	TNK	<b>0 414 799 005</b>	<b>0 986 445 002</b> <b>0 986 445 102</b>
			Komp.Nr. 505108 /05/06	09.96-09.03	TNK	<b>0 414 799 015</b>	
<b>2535</b> [SKN]	11,9	260	OM 541.942 <(501)LA Euro3> Komp.Nr. 505108/01	09.96-09.03	TNK	<b>0 414 799 005</b>	<b>0 986 445 002</b> <b>0 986 445 102</b>
			Komp.Nr. 505108/05	09.96-09.03	TNK	<b>0 414 799 015</b>	





◀ MERCEDES-BENZ

2535 L [SKN]	12,0	260	OM 541.922 <(501)LA Euro2>	09.96-09.03	TNK	0 414 799 005	0 986 445 002
			Komp.Nr. 505108 /01/02				0 986 445 102
			Komp.Nr. 505108 /05/06	09.96-09.03	TNK	0 414 799 015	
2540 [SKN]	11,9	290	OM 541.944 <(501)LA Euro3>	09.96-09.03	TNK	0 414 799 005	0 986 445 002
			Komp.Nr. 505108/01				0 986 445 102
			Komp.Nr. 505108/05	09.96-09.03	TNK	0 414 799 015	
, L [SKN]	12,0	290	OM 541.923 <(501)LA Euro2>	09.96-09.03	TNK	0 414 799 005	0 986 445 002
			Komp.Nr. 505108 /01/02				0 986 445 102
			Komp.Nr. 505108 /05/06	09.96-09.03	TNK	0 414 799 015	
2543 [SKN]	11,9	315	OM 541.946 <(501)LA Euro3>	09.96-09.03	TNK	0 414 799 005	0 986 445 002
			Komp.Nr. 505108/01				0 986 445 102
			Komp.Nr. 505108/05	09.96-09.03	TNK	0 414 799 015	
, L [SKN]	12,0	315	OM 541.925 <(501)LA Euro2>	09.96-09.03	TNK	0 414 799 015	0 986 445 002
			Komp.Nr. 505108 /05/06				0 986 445 102
			Komp.Nr. 505108/01	09.96-09.03	TNK	0 414 799 005	0 986 445 102
2548 [SKN]	15,9	350	OM 542.940 <(502)LA Euro3>	09.96-09.03	TNK	0 414 799 005	0 986 445 002
			Komp.Nr. 505108 /01/02				0 986 445 102
			Komp.Nr. 505108 /04	09.96-09.03	TNK	0 414 799 007	
			Komp.Nr. 505108 /06	09.96-09.03	TNK	0 414 799 015	
, L [SKN]	16,0	350	OM 542.921 <(502)LA Euro2>	09.96-09.03	TNK	0 414 799 005	0 986 445 002
			Komp.Nr. 505108 /01/02				0 986 445 102
2553 [SKN]	15,9	390	OM 542.942 <(502)LA Euro3>	09.96-09.03	TNK	0 414 799 005	0 986 445 002
			Komp.Nr. 505108 /01/02				0 986 445 102
			Komp.Nr. 505108 /04	09.96-09.03	TNK	0 414 799 007	
			Komp.Nr. 505108 /06	09.96-09.03	TNK	0 414 799 015	
, L [SKN]	16,0	390	OM 542.920 <(502)LA Euro2>	09.96-09.03	TNK	0 414 799 005	0 986 445 002
			Komp.Nr. 505108 /01/02				0 986 445 102
2557 L [SKN]	15,9	420	OM 542.944 <(502)LA Euro3>	09.96-09.03	TNK	0 414 799 005	0 986 445 002
			Komp.Nr. 505108 /01/02				0 986 445 102
			Komp.Nr. 505108 /04	09.96-09.03	TNK	0 414 799 007	
			Komp.Nr. 505108 /06	09.96-09.03	TNK	0 414 799 015	
	16,0	420	OM 542.922 <(502)LA Euro2>	04.97-09.03	TNK	0 414 799 005	0 986 445 002
			Komp.Nr. 505108 /01/02				0 986 445 102
2631 [SKN]	11,9	230	OM 541.940 <(501)LA Euro3>	04.97-09.03	TNK	0 414 799 005	0 986 445 002
			Komp.Nr. 505108/01				0 986 445 102
			Komp.Nr. 505108/05	04.97-09.03	TNK	0 414 799 015	
, L [SKN]	12,0	230	OM 541.920 <(501)LA Euro2>	04.97-09.03	TNK	0 414 799 005	0 986 445 002
			Komp.Nr. 505108 /01/02				0 986 445 102
			Komp.Nr. 505108 /05/06	04.97-09.03	TNK	0 414 799 015	
2635 [SKN]	11,9	260	OM 541.942 <(501)LA Euro3>	04.97-09.03	TNK	0 414 799 005	0 986 445 002
			Komp.Nr. 505108/01				0 986 445 102
			Komp.Nr. 505108/05	04.97-09.03	TNK	0 414 799 015	
, L [SKN]	12,0	260	OM 541.922 <(501)LA Euro2>	04.97-09.03	TNK	0 414 799 005	0 986 445 002
			Komp.Nr. 505108 /01/02				0 986 445 102
			Komp.Nr. 505108 /05/06	04.97-09.03	TNK	0 414 799 015	





<b>2640</b> [SKN]	11,9	290	OM 541.944 <(501)LA Euro2> Komp.Nr. 505108/01	09.96-09.03	TNK	<b>0 414 799 005</b>	<b>0 986 445 002</b> <b>0 986 445 102</b>
			Komp.Nr. 505108/05	09.96-09.03	TNK	<b>0 414 799 015</b>	
, L [SKN]	12,0	290	OM 541.923 <(501)LA Euro2> Komp.Nr. 505108 /01/02	09.96-09.03	TNK	<b>0 414 799 005</b>	<b>0 986 445 002</b> <b>0 986 445 102</b>
			Komp.Nr. 505108 /05/06	09.96-09.03	TNK	<b>0 414 799 015</b>	
<b>2643</b> [SKN]	11,9	315	OM 541.946 <(501)LA Euro3> Komp.Nr. 505108/01	09.96-09.03	TNK	<b>0 414 799 005</b>	<b>0 986 445 002</b> <b>0 986 445 102</b>
			Komp.Nr. 505108/05	09.96-09.03	TNK	<b>0 414 799 015</b>	
, L [SKN]	12,0	315	OM 541.925 <(501)LA Euro2> Komp.Nr. 505108 /05/06	09.96-09.03	TNK	<b>0 414 799 015</b>	<b>0 986 445 002</b> <b>0 986 445 102</b>
			Komp.Nr. 505108/01	09.96-09.03	TNK	<b>0 414 799 005</b>	<b>0 986 445 002</b> <b>0 986 445 102</b>
<b>2648</b> [SKN]	15,9	350	OM 542.940 <(502)LA Euro3> Komp.Nr. 505108 /01/02	09.96-09.03	TNK	<b>0 414 799 005</b>	<b>0 986 445 002</b> <b>0 986 445 102</b>
			Komp.Nr. 505108 /04	09.96-09.03	TNK	<b>0 414 799 007</b>	
			Komp.Nr. 505108 /06	09.96-09.03	TNK	<b>0 414 799 015</b>	
, L [SKN]	16,0	350	OM 542.921 <(502)LA Euro2> Komp.Nr. 505108 /01/02	09.96-09.03	TNK	<b>0 414 799 005</b>	<b>0 986 445 002</b> <b>0 986 445 102</b>
<b>2653</b> [SKN]	15,9	390	OM 542.942 <(502)LA Euro3> Komp.Nr. 505108 /01/02	09.96-09.03	TNK	<b>0 414 799 005</b>	<b>0 986 445 002</b> <b>0 986 445 102</b>
			Komp.Nr. 505108 /04	09.96-09.03	TNK	<b>0 414 799 007</b>	
			Komp.Nr. 505108 /06	09.96-09.03	TNK	<b>0 414 799 015</b>	
, L [SKN]	16,0	390	OM 542.920 <(502)LA Euro2> Komp.Nr. 505108 /01/02	09.96-09.03	TNK	<b>0 414 799 005</b>	<b>0 986 445 002</b> <b>0 986 445 102</b>
<b>2657</b> [SKN]	15,9	420	OM 542.944 <(502)LA Euro3> Komp.Nr. 505108 /01/02	09.96-09.03	TNK	<b>0 414 799 005</b>	<b>0 986 445 002</b> <b>0 986 445 102</b>
			Komp.Nr. 505108 /04	09.96-09.03	TNK	<b>0 414 799 007</b>	
			Komp.Nr. 505108 /06	09.96-09.03	TNK	<b>0 414 799 015</b>	
, L [SKN]	16,0	420	OM 542.922 <(502)LA Euro2> Komp.Nr. 505108 /01/02	04.97-09.03	TNK	<b>0 414 799 005</b>	<b>0 986 445 002</b> <b>0 986 445 102</b>
<b>3231</b> [SKN]	12,0	230	OM 541.920 <(501)LA Euro2> Komp.Nr. 505108 /01/02	04.97-09.03	TNK	<b>0 414 799 005</b>	<b>0 986 445 002</b> <b>0 986 445 102</b>
			Komp.Nr. 505108 /05/06	04.97-09.03	TNK	<b>0 414 799 015</b>	
<b>3235</b> [SKN]	12,0	260	OM 541.922 <(501)LA Euro2> Komp.Nr. 505108 /01/02	04.97-09.03	TNK	<b>0 414 799 005</b>	<b>0 986 445 002</b> <b>0 986 445 102</b>
			Komp.Nr. 505108 /05/06	04.97-09.03	TNK	<b>0 414 799 015</b>	
<b>3240</b> [SKN]	12,0	290	OM 541.923 <(501)LA Euro2> Komp.Nr. 505108 /01/02	04.97-09.03	TNK	<b>0 414 799 005</b>	<b>0 986 445 002</b> <b>0 986 445 102</b>
			Komp.Nr. 505108 /05/06	04.97-09.03	TNK	<b>0 414 799 015</b>	
<b>3243</b> [SKN]	12,0	315	OM 541.925 <(501)LA Euro2> Komp.Nr. 505108 /05/06	04.97-09.03	TNK	<b>0 414 799 015</b>	<b>0 986 445 002</b> <b>0 986 445 102</b>
			Komp.Nr. 505108/01	04.97-09.03	TNK	<b>0 414 799 005</b>	<b>0 986 445 002</b> <b>0 986 445 102</b>
<b>3331</b> , A [SKN]	12,0	230	OM 541.920 <(501)LA Euro2>; OM 541.926 <(501)LA Euro2> Komp.Nr. 505108 /01/02	04.97-09.03	TNK	<b>0 414 799 005</b>	<b>0 986 445 002</b> <b>0 986 445 102</b>
			Komp.Nr. 505108 /05/06	04.97-09.03	TNK	<b>0 414 799 015</b>	





◀ MERCEDES-BENZ

<b>3335</b> [SKN]	12,0	260	OM 541.922 <(501)LA Euro2> Komp.Nr. 505108 /01/02	04.97-09.03	TNK	<b>0 414 799 005</b>	<b>0 986 445 002</b> <b>0 986 445 102</b>
			Komp.Nr. 505108 /05/06	04.97-09.03	TNK	<b>0 414 799 015</b>	
<b>3340</b> , A [SKN]	12,0	290	OM 541.923 <(501)LA Euro2>; OM 541.924 <(501)LA Euro 2>				
			Komp.Nr. 505108 /01/02	04.97-09.03	TNK	<b>0 414 799 005</b>	<b>0 986 445 002</b> <b>0 986 445 102</b>
			Komp.Nr. 505108 /05/06	04.97-09.03	TNK	<b>0 414 799 015</b>	
<b>3343</b> [SKN]	12,0	315	OM 541.925 <(501)LA Euro2>				
			Komp.Nr. 505108 /05/06	04.97-09.03	TNK	<b>0 414 799 015</b>	
			Komp.Nr. 505108/01	04.97-09.03	TNK	<b>0 414 799 005</b>	<b>0 986 445 002</b> <b>0 986 445 102</b>
A [SKN]	12,0	315	OM 541.921 <(501)LA Euro2>				
			Komp.Nr. 505108 /01/02	04.97-09.03	TNK	<b>0 414 799 005</b>	<b>0 986 445 002</b> <b>0 986 445 102</b>
			Komp.Nr. 505108 /05/06	04.97-09.03	TNK	<b>0 414 799 015</b>	
<b>3348</b> [SKN]	16,0	350	OM 542.921 <(502)LA Euro2>				
			Komp.Nr. 505108 /01/02	04.97-09.03	TNK	<b>0 414 799 005</b>	<b>0 986 445 002</b> <b>0 986 445 102</b>
A [SKN]	16,0	350	OM 542.925 <(502)LA Euro2>	04.97-09.03		<b>0 414 799 005</b>	<b>0 986 445 002</b> <b>0 986 445 102</b>
<b>3353</b> [SKN]	16,0	390	OM 542... <(502)LA>				
			Mot. Typ 542.920	09.96-09.03	TW	<b>0 414 799 005</b>	<b>0 986 445 002</b> <b>0 986 445 102</b>
			Mot. Typ 542.926				
			Mot. Typ 542.943				
			Mot. Typ 542.926	09.96-09.03	TW	<b>0 414 799 015</b>	
			Mot. Typ 542.943				
			Mot. Typ 542.943	09.96-09.03	TW	<b>0 414 799 007</b>	
<b>3357</b> [SKN]	16,0	420	OM 542.922 <(502)LA Euro2>				
			Komp.Nr. 505108 /01/02	04.97-09.03	TNK	<b>0 414 799 005</b>	<b>0 986 445 002</b> <b>0 986 445 102</b>
<b>4140</b> , A [SKN]	12,0	290	OM 541.923 <(501)LA Euro2>; OM 541.924 <(501)LA Euro2>				
			Komp.Nr. 505108 /01/02	04.97-09.03	TNK	<b>0 414 799 005</b>	<b>0 986 445 002</b> <b>0 986 445 102</b>
			Komp.Nr. 505108 /05/06	04.97-09.03	TNK	<b>0 414 799 015</b>	
<b>4143</b> [SKN]	12,0	315	OM 541.925 <(501)LA Euro2>				
			Komp.Nr. 505108 /05/06	04.97-09.03	TNK	<b>0 414 799 015</b>	
			Komp.Nr. 505108/01	04.97-09.03	TNK	<b>0 414 799 005</b>	<b>0 986 445 002</b> <b>0 986 445 102</b>
A [SKN]	12,0	315	OM 541.921 <(501)LA Euro2>				
			Komp.Nr. 505108 /01/02	04.97-09.03	TNK	<b>0 414 799 005</b>	<b>0 986 445 002</b> <b>0 986 445 102</b>
			Komp.Nr. 505108 /05/06	04.97-09.03	TNK	<b>0 414 799 015</b>	
<b>4148</b> [SKN]	15,9	350	OM 542.925 <(502)LA Euro2>	04.97-09.03		<b>0 414 799 005</b>	<b>0 986 445 002</b> <b>0 986 445 102</b>
	16,0	350	OM 542.921 <(502)LA Euro2>				
			Komp.Nr. 505108 /01/02	04.97-09.03	TNK	<b>0 414 799 005</b>	<b>0 986 445 002</b> <b>0 986 445 102</b>
<b>Actros II</b>							
<b>1832</b> [MP2]	12,0	235	OM 541.940 <501 LA Euro3>				
			Komp.Nr. 505108/01	04.03-12.08	TNK	<b>0 414 799 005</b>	<b>0 986 445 002</b> <b>0 986 445 102</b>
			Komp.Nr. 505108/05	04.03-12.08	TNK	<b>0 414 799 015</b>	
BlueTec [MP2]	12,0	235	OM 541.970 <501 LA Euro4/5>				
			Komp.Nr. 505108 /01	02.05-12.08	TNK	<b>0 414 799 005</b>	<b>0 986 445 002</b> <b>0 986 445 102</b>
			Komp.Nr. 505108/05	02.05-12.08	TNK	<b>0 414 799 015</b>	
<b>1836</b> [MP2]	12,0	265	OM 541.942 <501 LA Euro3>				
			Komp.Nr. 505108/01	04.03-12.08	TNK	<b>0 414 799 005</b>	<b>0 986 445 002</b> <b>0 986 445 102</b>
			Komp.Nr. 505108/05	04.03-12.08	TNK	<b>0 414 799 015</b>	







<b>1836</b> BlueTec [MP2]	12,0	265	OM 541.972 <501 LA Euro4/5>	02.05-12.08	TNK	<b>0 414 799 005</b>	<b>0 986 445 002</b>
			Komp.Nr. 505108 /01				<b>0 986 445 102</b>
			Komp.Nr. 505108/05	02.05-12.08	TNK	<b>0 414 799 015</b>	
<b>1841</b> [MP2]	12,0	300	OM 541.944 <501 LA Euro3>	04.03-12.08	TNK	<b>0 414 799 005</b>	<b>0 986 445 002</b>
			Komp.Nr. 505108/01				<b>0 986 445 102</b>
			Komp.Nr. 505108/05	04.03-12.08	TNK	<b>0 414 799 015</b>	
BlueTec [MP2]	12,0	300	OM 541.974 <501 LA Euro4/5>	02.05-12.08	TNK	<b>0 414 799 005</b>	<b>0 986 445 002</b>
			Komp.Nr. 505108 /01				<b>0 986 445 102</b>
			Komp.Nr. 505108/05	02.05-12.08	TNK	<b>0 414 799 015</b>	
<b>1844</b> [MP2]	12,0	320	OM 541.946 <501 LA Euro3>	04.03-12.08	TNK	<b>0 414 799 005</b>	<b>0 986 445 002</b>
			Komp.Nr. 505108/01				<b>0 986 445 102</b>
			Komp.Nr. 505108/05	04.03-12.08	TNK	<b>0 414 799 015</b>	
BlueTec [MP2]	12,0	320	OM 541.976 <501 LA Euro4/5>	02.05-12.08	TNK	<b>0 414 799 005</b>	<b>0 986 445 002</b>
			Komp.Nr. 505108 /01				<b>0 986 445 102</b>
			Komp.Nr. 505108/05	02.05-12.08	TNK	<b>0 414 799 015</b>	
<b>1846</b> [MP2]	12,0	335	OM 541... <501 LA Euro3>	04.03-12.08	TNK	<b>0 414 799 005</b>	<b>0 986 445 002</b>
			Komp.Nr. 505108/01				<b>0 986 445 102</b>
			Komp.Nr. 505108/05	04.03-12.08	TNK	<b>0 414 799 015</b>	
BlueTec [MP2]	12,0	335	OM 541.980 <501 LA Euro4/5>	02.05-12.08	TNK	<b>0 414 799 005</b>	<b>0 986 445 002</b>
			Komp.Nr. 505108 /01				<b>0 986 445 102</b>
			Komp.Nr. 505108/05	02.05-12.08	TNK	<b>0 414 799 015</b>	
<b>1848</b> BlueTec [MP2]	12,0	350	OM 541.978 <501 LA Euro4/5>	02.05-12.08	TNK	<b>0 414 799 005</b>	<b>0 986 445 002</b>
			Komp.Nr. 505108 /01				<b>0 986 445 102</b>
			Komp.Nr. 505108/05	02.05-12.08	TNK	<b>0 414 799 015</b>	
<b>1850</b> [MP2]	15,9	370	OM 542.940 <502 LA Euro3>	04.03-12.08	TNK	<b>0 414 799 005</b>	<b>0 986 445 002</b>
			Komp.Nr. 505108 /01/02				<b>0 986 445 102</b>
			Komp.Nr. 505108 /04				04.03-12.08
			Komp.Nr. 505108 /06	04.03-12.08	TNK	<b>0 414 799 015</b>	
<b>1851</b> BlueTec [MP2]	15,9	375	OM 542.960 <502 LA Euro4/5>	02.05-12.08	TNK	<b>0 414 799 005</b>	<b>0 986 445 002</b>
			Komp.Nr. 505108 /02				<b>0 986 445 102</b>
			Komp.Nr. 505108 /06	02.05-12.08	TNK	<b>0 414 799 015</b>	
<b>1854</b> [MP2]	15,9	395	OM 542.942 <502 LA Euro3>	04.03-12.08	TNK	<b>0 414 799 005</b>	<b>0 986 445 002</b>
			Komp.Nr. 505108 /01/02				<b>0 986 445 102</b>
			Komp.Nr. 505108 /04				04.03-12.08
			Komp.Nr. 505108 /06	04.03-12.08	TNK	<b>0 414 799 015</b>	
<b>1855</b> BlueTec [MP2]	15,9	405	OM 542.962 <502 LA Euro4/5>	07.05-12.08	TNK	<b>0 414 799 005</b>	<b>0 986 445 002</b>
			Komp.Nr. 505108 /02				<b>0 986 445 102</b>
			Komp.Nr. 505108 /06				07.05-12.08
<b>1858</b> [MP2]	15,9	425	OM 542.944 <502 LA Euro3>	04.03-12.08	TNK	<b>0 414 799 005</b>	<b>0 986 445 002</b>
			Komp.Nr. 505108 /01/02				<b>0 986 445 102</b>
			Komp.Nr. 505108 /04				04.03-12.08
			Komp.Nr. 505108 /06	04.03-12.08	TNK	<b>0 414 799 015</b>	
<b>1860</b> BlueTec [MP2]	15,9	440	OM 542.964 <502 LA Euro4/5>	07.05-12.08	TNK	<b>0 414 799 005</b>	<b>0 986 445 002</b>
			Komp.Nr. 505108 /02				<b>0 986 445 102</b>
			Komp.Nr. 505108 /06				07.05-12.08
<b>1861</b> Black Edition [MP2]	15,9	450	OM 542.958 <502 LA Euro3>	09.04-12.08	TNK	<b>0 414 799 005</b>	<b>0 986 445 002</b>
			Komp.Nr. 505108 /01/02				<b>0 986 445 102</b>
			Komp.Nr. 505108 /06	09.04-12.08	TNK	<b>0 414 799 015</b>	





◀ MERCEDES-BENZ

<b>2032</b> [MP2]	12,0	235	OM 541.940,941 <501 LA Euro3> Komp.Nr. 505108 /05/06 Komp.Nr. 505108/01	04.03-12.08 TNK 04.03-12.08 TNK	<b>0 414 799 015</b> <b>0 414 799 005</b> <b>0 986 445 002</b> <b>0 986 445 102</b>
BlueTec [MP2]	12,0	235	OM 541.970 <501 LA Euro4/5> Komp.Nr. 505108 /01 Komp.Nr. 505108/05	02.05-12.08 TNK 02.05-12.08 TNK	<b>0 414 799 005</b> <b>0 986 445 002</b> <b>0 986 445 102</b> <b>0 414 799 015</b>
<b>2036</b> [MP2]	12,0	265	OM 541... <501 LA Euro3> Komp.Nr. 505108/01 Komp.Nr. 505108/05	04.03-12.08 TNK 04.03-12.08 TNK	<b>0 414 799 005</b> <b>0 986 445 002</b> <b>0 986 445 102</b> <b>0 414 799 015</b>
BlueTec [MP2]	12,0	265	OM 541.972 <501 LA Euro4/5> Komp.Nr. 505108 /01 Komp.Nr. 505108/05	02.05-12.08 TNK 02.05-12.08 TNK	<b>0 414 799 005</b> <b>0 986 445 002</b> <b>0 986 445 102</b> <b>0 414 799 015</b>
<b>2041</b> [MP2]	12,0	300	OM 541.944 <501 LA Euro3> Komp.Nr. 505108/01 Komp.Nr. 505108/05	04.03-12.08 TNK 04.03-12.08 TNK	<b>0 414 799 005</b> <b>0 986 445 002</b> <b>0 986 445 102</b> <b>0 414 799 015</b>
BlueTec [MP2]	12,0	300	OM 541.974 <501 LA Euro4/5> Komp.Nr. 505108 /01 Komp.Nr. 505108/05	02.05-12.08 TNK 02.05-12.08 TNK	<b>0 414 799 005</b> <b>0 986 445 002</b> <b>0 986 445 102</b> <b>0 414 799 015</b>
<b>2044</b> [MP2]	12,0	320	OM 541... <501 LA Euro3> Komp.Nr. 505108/01 Komp.Nr. 505108/05	04.03-12.08 TNK 04.03-12.08 TNK	<b>0 414 799 005</b> <b>0 986 445 002</b> <b>0 986 445 102</b> <b>0 414 799 015</b>
BlueTec [MP2]	12,0	320	OM 541.976 <501 LA Euro4/5> Komp.Nr. 505108 /01 Komp.Nr. 505108/05	02.05-12.08 TNK 02.05-12.08 TNK	<b>0 414 799 005</b> <b>0 986 445 002</b> <b>0 986 445 102</b> <b>0 414 799 015</b>
<b>2046</b> [MP2]	12,0	335	OM 541... <501 LA Euro3> Komp.Nr. 505108/01 Komp.Nr. 505108/05	04.03-12.08 TNK 04.03-12.08 TNK	<b>0 414 799 005</b> <b>0 986 445 002</b> <b>0 986 445 102</b> <b>0 414 799 015</b>
BlueTec [MP2]	12,0	335	OM 541.980 <501 LA Euro4/5> Komp.Nr. 505108 /01 Komp.Nr. 505108/05	02.05-12.08 TNK 02.05-12.08 TNK	<b>0 414 799 005</b> <b>0 986 445 002</b> <b>0 986 445 102</b> <b>0 414 799 015</b>
<b>2048</b> BlueTec [MP2]	12,0	350	OM 541.978 <501 LA Euro4/5> Komp.Nr. 505108 /01 Komp.Nr. 505108/05	02.05-12.08 TNK 02.05-12.08 TNK	<b>0 414 799 005</b> <b>0 986 445 002</b> <b>0 986 445 102</b> <b>0 414 799 015</b>
<b>2050</b> [MP2]	15,9	370	OM 542.940 <502 LA Euro3> Komp.Nr. 505108 /01/02 Komp.Nr. 505108 /04 Komp.Nr. 505108 /06	04.03-12.08 TNK 04.03-12.08 TNK 04.03-12.08 TNK	<b>0 414 799 005</b> <b>0 986 445 002</b> <b>0 986 445 102</b> <b>0 414 799 007</b> <b>0 414 799 015</b>
<b>2051</b> BlueTec [MP2]	15,9	375	OM 542.960 <502 LA Euro4/5> Komp.Nr. 505108 /02 Komp.Nr. 505108 /06	09.05-12.08 TNK 09.05-12.08 TNK	<b>0 414 799 005</b> <b>0 986 445 002</b> <b>0 986 445 102</b> <b>0 414 799 015</b>
<b>2054</b> [MP2]	15,9	395	OM 542.942 <502 LA Euro3> Komp.Nr. 505108 /01/02 Komp.Nr. 505108 /04 Komp.Nr. 505108 /06	04.03-12.08 TNK 04.03-12.08 TNK 04.03-12.08 TNK	<b>0 414 799 005</b> <b>0 986 445 002</b> <b>0 986 445 102</b> <b>0 414 799 007</b> <b>0 414 799 015</b>
<b>2055</b> BlueTec [MP2]	15,9	405	OM 542.962 <502 LA Euro4/5> Komp.Nr. 505108 /02 Komp.Nr. 505108 /06	07.05-12.08 TNK 07.05-12.08 TNK	<b>0 414 799 005</b> <b>0 986 445 002</b> <b>0 986 445 102</b> <b>0 414 799 015</b>





2532 [MP2]	12,0	235	OM 541.940 <501 LA Euro3>					
			Komp.Nr. 505108 /05/06	04.03-12.08	TNK	<b>0 414 799 015</b>		
			Komp.Nr. 505108/01	04.03-12.08	TNK	<b>0 414 799 005</b>	<b>0 986 445 002</b>	<b>0 986 445 102</b>
BlueTec [MP2]	12,0	235	OM 541.970 <501 LA Euro4/5>					
			Komp.Nr. 505108 /01	02.05-12.08	TNK	<b>0 414 799 005</b>	<b>0 986 445 002</b>	<b>0 986 445 102</b>
			Komp.Nr. 505108/05	02.05-12.08	TNK	<b>0 414 799 015</b>		
2536 [MP2]	12,0	265	OM 541.942 <501 LA Euro3>					
			Komp.Nr. 505108/01	04.03-12.08	TNK	<b>0 414 799 005</b>	<b>0 986 445 002</b>	<b>0 986 445 102</b>
			Komp.Nr. 505108/05	04.03-12.08	TNK	<b>0 414 799 015</b>		
BlueTec [MP2]	12,0	265	OM 541.972 <501 LA Euro4/5>					
			Komp.Nr. 505108 /01	02.05-12.08	TNK	<b>0 414 799 005</b>	<b>0 986 445 002</b>	<b>0 986 445 102</b>
			Komp.Nr. 505108/05	02.05-12.08	TNK	<b>0 414 799 015</b>		
2541 [MP2]	12,0	300	OM 541.944 <501 LA Euro3>					
			Komp.Nr. 505108/01	04.03-12.08	TNK	<b>0 414 799 005</b>	<b>0 986 445 002</b>	<b>0 986 445 102</b>
			Komp.Nr. 505108/05	04.03-12.08	TNK	<b>0 414 799 015</b>		
BlueTec [MP2]	12,0	300	OM 541.974 <501 LA Euro4/5>					
			Komp.Nr. 505108 /01	02.05-12.08	TNK	<b>0 414 799 005</b>	<b>0 986 445 002</b>	<b>0 986 445 102</b>
			Komp.Nr. 505108/05	02.05-12.08	TNK	<b>0 414 799 015</b>		
2544 [MP2]	12,0	320	OM 541.946 <501 LA Euro3>					
			Komp.Nr. 505108/01	04.03-12.08	TNK	<b>0 414 799 005</b>	<b>0 986 445 002</b>	<b>0 986 445 102</b>
			Komp.Nr. 505108/05	04.03-12.08	TNK	<b>0 414 799 015</b>		
BlueTec [MP2]	12,0	320	OM 541.976 <501 LA Euro4/5>					
			Komp.Nr. 505108 /01	02.05-12.08	TNK	<b>0 414 799 005</b>	<b>0 986 445 002</b>	<b>0 986 445 102</b>
			Komp.Nr. 505108/05	02.05-12.08	TNK	<b>0 414 799 015</b>		
2546 [MP2]	12,0	335	OM 541.948 <501 LA Euro3>					
			Komp.Nr. 505108/01	04.03-12.08	TNK	<b>0 414 799 005</b>	<b>0 986 445 002</b>	<b>0 986 445 102</b>
			Komp.Nr. 505108/05	04.03-12.08	TNK	<b>0 414 799 015</b>		
BlueTec [MP2]	12,0	335	OM 541.980 <501 LA Euro4/5>					
			Komp.Nr. 505108 /01	02.05-12.08	TNK	<b>0 414 799 005</b>	<b>0 986 445 002</b>	<b>0 986 445 102</b>
			Komp.Nr. 505108/05	02.05-12.08	TNK	<b>0 414 799 015</b>		
2548 BlueTec [MP2]	12,0	350	OM 541.978 <501 LA Euro4/5>					
			Komp.Nr. 505108 /01	02.05-12.08	TNK	<b>0 414 799 005</b>	<b>0 986 445 002</b>	<b>0 986 445 102</b>
			Komp.Nr. 505108/05	02.05-12.08	TNK	<b>0 414 799 015</b>		
2550 [MP2]	15,9	370	OM 542.940 <502 LA Euro3>					
			Komp.Nr. 505108 /01/02	04.03-12.08	TNK	<b>0 414 799 005</b>	<b>0 986 445 002</b>	<b>0 986 445 102</b>
			Komp.Nr. 505108 /04	04.03-12.08	TNK	<b>0 414 799 007</b>		
2551 BlueTec [MP2]	15,9	375	OM 542.960 <502 LA Euro4/5>					
			Komp.Nr. 505108 /02	02.05-12.08	TNK	<b>0 414 799 005</b>	<b>0 986 445 002</b>	<b>0 986 445 102</b>
			Komp.Nr. 505108 /06	02.05-12.08	TNK	<b>0 414 799 015</b>		
2554 [MP2]	15,9	395	OM 542.942 <502 LA Euro3>					
			Komp.Nr. 505108 /01/02	04.03-12.08	TNK	<b>0 414 799 005</b>	<b>0 986 445 002</b>	<b>0 986 445 102</b>
			Komp.Nr. 505108 /04	04.03-12.08	TNK	<b>0 414 799 007</b>		
2555 BlueTec [MP2]	15,9	405	OM 542.962 <502 LA Euro4/5>					
			Komp.Nr. 505108 /02	07.05-12.08	TNK	<b>0 414 799 005</b>	<b>0 986 445 002</b>	<b>0 986 445 102</b>
			Komp.Nr. 505108 /06	07.05-12.08	TNK	<b>0 414 799 015</b>		





◀ MERCEDES-BENZ

<b>2558</b> [MP2]	15,9	425	OM 542.944 <502 LA Euro3> Komp.Nr. 505108 /01/02	04.03-12.08	TNK	<b>0 414 799 005</b>	<b>0 986 445 002</b> <b>0 986 445 102</b>
			Komp.Nr. 505108 /04	04.03-12.08	TNK	<b>0 414 799 007</b>	
			Komp.Nr. 505108 /06	04.03-12.08	TNK	<b>0 414 799 015</b>	
<b>2560</b> BlueTec [MP2]	15,9	440	OM 542.964 <502 LA Euro4/5> Komp.Nr. 505108 /02	07.05-12.08	TNK	<b>0 414 799 005</b>	<b>0 986 445 002</b> <b>0 986 445 102</b>
			Komp.Nr. 505108 /06	07.05-12.08	TNK	<b>0 414 799 015</b>	
<b>2632</b> [MP2]	12,0	235	OM 541.940 <501 LA Euro3> Komp.Nr. 505108 /05/06	04.03-12.08	TNK	<b>0 414 799 015</b>	
			Komp.Nr. 505108 /01	04.03-12.08	TNK	<b>0 414 799 005</b>	<b>0 986 445 002</b> <b>0 986 445 102</b>
BlueTec [MP2]	12,0	235	OM 541.970 <501 LA Euro4/5> Komp.Nr. 505108 /01	09.05-12.08	TNK	<b>0 414 799 005</b>	<b>0 986 445 002</b> <b>0 986 445 102</b>
			Komp.Nr. 505108 /05	09.05-12.08	TNK	<b>0 414 799 015</b>	
<b>2636</b> [MP2]	12,0	265	OM 541.942 <501 LA Euro3> Komp.Nr. 505108 /01	04.03-12.08	TNK	<b>0 414 799 005</b>	<b>0 986 445 002</b> <b>0 986 445 102</b>
			Komp.Nr. 505108 /05	04.03-12.08	TNK	<b>0 414 799 015</b>	
BlueTec [MP2]	12,0	265	OM 541.972 <501 LA Euro4/5> Komp.Nr. 505108 /01	09.05-12.08	TNK	<b>0 414 799 005</b>	<b>0 986 445 002</b> <b>0 986 445 102</b>
			Komp.Nr. 505108 /05	09.05-12.08	TNK	<b>0 414 799 015</b>	
<b>2641</b> [MP2]	12,0	300	OM 541.944 <501 LA Euro3> Komp.Nr. 505108 /01	06.03-12.08	TNK	<b>0 414 799 005</b>	<b>0 986 445 002</b> <b>0 986 445 102</b>
			Komp.Nr. 505108 /05	06.03-12.08	TNK	<b>0 414 799 015</b>	
BlueTec [MP2]	11,9	300	OM 541.974 <501 LA Euro4/5> Komp.Nr. 505108 /01	09.05-12.08	TNK	<b>0 414 799 005</b>	<b>0 986 445 002</b> <b>0 986 445 102</b>
			Komp.Nr. 505108 /05	09.05-12.08	TNK	<b>0 414 799 015</b>	
<b>2644</b> [MP2]	12,0	320	OM 541.946 <501 LA Euro3> Komp.Nr. 505108 /01	06.03-12.08	TNK	<b>0 414 799 005</b>	<b>0 986 445 002</b> <b>0 986 445 102</b>
			Komp.Nr. 505108 /05	06.03-12.08	TNK	<b>0 414 799 015</b>	
BlueTec [MP2]	12,0	320	OM 541.976 <501 LA Euro4/5> Komp.Nr. 505108 /01	09.05-12.08	TNK	<b>0 414 799 005</b>	<b>0 986 445 002</b> <b>0 986 445 102</b>
			Komp.Nr. 505108 /05	09.05-12.08	TNK	<b>0 414 799 015</b>	
<b>2646</b> [MP2]	12,0	335	OM 541.948 <501 LA Euro3> Komp.Nr. 505108 /01	06.03-12.08	TNK	<b>0 414 799 005</b>	<b>0 986 445 002</b> <b>0 986 445 102</b>
			Komp.Nr. 505108 /05	06.03-12.08	TNK	<b>0 414 799 015</b>	
BlueTec [MP2]	12,0	335	OM 541.980 <501 LA Euro4/5> Komp.Nr. 505108 /01	09.05-12.08	TNK	<b>0 414 799 005</b>	<b>0 986 445 002</b> <b>0 986 445 102</b>
			Komp.Nr. 505108 /05	09.05-12.08	TNK	<b>0 414 799 015</b>	
<b>2648</b> BlueTec [MP2]	12,0	350	OM 541.978 <501 LA Euro4/5> Komp.Nr. 505108 /01	02.05-12.08	TNK	<b>0 414 799 005</b>	<b>0 986 445 002</b> <b>0 986 445 102</b>
			Komp.Nr. 505108 /05	02.05-12.08	TNK	<b>0 414 799 015</b>	
<b>2650</b> [MP2]	15,9	370	OM 542.940 <502 LA Euro3> Komp.Nr. 505108 /01/02	04.03-12.08	TNK	<b>0 414 799 005</b>	<b>0 986 445 002</b> <b>0 986 445 102</b>
			Komp.Nr. 505108 /04	04.03-12.08	TNK	<b>0 414 799 007</b>	
			Komp.Nr. 505108 /06	04.03-12.08	TNK	<b>0 414 799 015</b>	
<b>2651</b> BlueTec [MP2]	15,9	375	OM 542.960 <502 LA Euro4/5> Komp.Nr. 505108 /02	09.05-12.08	TNK	<b>0 414 799 005</b>	<b>0 986 445 002</b> <b>0 986 445 102</b>
			Komp.Nr. 505108 /06	09.05-12.08	TNK	<b>0 414 799 015</b>	





<b>2654</b> [MP2]	15,9	395	OM 542.942 <502 LA Euro3> Komp.Nr. 505108 /01/02	04.03-12.08	TNK	<b>0 414 799 005</b>	<b>0 986 445 002</b> <b>0 986 445 102</b>
			Komp.Nr. 505108 /04	04.03-12.08	TNK	<b>0 414 799 007</b>	
			Komp.Nr. 505108 /06	04.03-12.08	TNK	<b>0 414 799 015</b>	
<b>2655</b> BlueTec [MP2]	15,9	405	OM 542.962 <502 LA Euro4/5> Komp.Nr. 505108 /02	09.05-12.08	TNK	<b>0 414 799 005</b>	<b>0 986 445 002</b> <b>0 986 445 102</b>
			Komp.Nr. 505108 /06	09.05-12.08	TNK	<b>0 414 799 015</b>	
<b>2658</b> [MP2]	15,9	425	OM 542.944 <502 LA Euro3> Komp.Nr. 505108 /01/02	04.03-12.08	TNK	<b>0 414 799 005</b>	<b>0 986 445 002</b> <b>0 986 445 102</b>
			Komp.Nr. 505108 /04	04.03-12.08	TNK	<b>0 414 799 007</b>	
			Komp.Nr. 505108 /06	04.03-12.08	TNK	<b>0 414 799 015</b>	
<b>3232</b> [MP2]	12,0	235	OM 541.940 <501 LA Euro3> Komp.Nr. 505108 /05/06	04.03-12.08	TNK	<b>0 414 799 015</b>	
			Komp.Nr. 505108/01	04.03-12.08	TNK	<b>0 414 799 005</b>	<b>0 986 445 002</b> <b>0 986 445 102</b>
BlueTec [MP2]	12,0	235	OM 541.970 <501 LA Euro4/5> Komp.Nr. 505108 /01	02.05-12.08	TNK	<b>0 414 799 005</b>	<b>0 986 445 002</b> <b>0 986 445 102</b>
			Komp.Nr. 505108/05	02.05-12.08	TNK	<b>0 414 799 015</b>	
<b>3236</b> [MP2]	12,0	265	OM 541.942 <501 LA Euro3> Komp.Nr. 505108/01	04.03-12.08	TNK	<b>0 414 799 005</b>	<b>0 986 445 002</b> <b>0 986 445 102</b>
			Komp.Nr. 505108/05	04.03-12.08	TNK	<b>0 414 799 015</b>	
BlueTec [MP2]	12,0	265	OM 541.972 <501 LA Euro4/5> Komp.Nr. 505108 /01	02.05-12.08	TNK	<b>0 414 799 005</b>	<b>0 986 445 002</b> <b>0 986 445 102</b>
			Komp.Nr. 505108/05	02.05-12.08	TNK	<b>0 414 799 015</b>	
<b>3241</b> [MP2]	12,0	300	OM 541.944 <501 LA Euro3> Komp.Nr. 505108/01	04.03-12.08	TNK	<b>0 414 799 005</b>	<b>0 986 445 002</b> <b>0 986 445 102</b>
			Komp.Nr. 505108/05	04.03-12.08	TNK	<b>0 414 799 015</b>	
BlueTec [MP2]	12,0	300	OM 541.974 <501 LA Euro4/5> Komp.Nr. 505108 /01	02.05-12.08	TNK	<b>0 414 799 005</b>	<b>0 986 445 002</b> <b>0 986 445 102</b>
			Komp.Nr. 505108/05	02.05-12.08	TNK	<b>0 414 799 015</b>	
<b>3244</b> BlueTec [MP2]	12,0	320	OM 541.976 <501 LA Euro4/5> Komp.Nr. 505108 /01	02.05-12.08	TNK	<b>0 414 799 005</b>	<b>0 986 445 002</b> <b>0 986 445 102</b>
			Komp.Nr. 505108/05	02.05-12.08	TNK	<b>0 414 799 015</b>	
<b>3246</b> [MP2]	12,0	335	OM 541.948 <501 LA Euro3> Komp.Nr. 505108/01	04.03-12.08	TNK	<b>0 414 799 005</b>	<b>0 986 445 002</b> <b>0 986 445 102</b>
			Komp.Nr. 505108/05	04.03-12.08	TNK	<b>0 414 799 015</b>	
BlueTec [MP2]	12,0	335	OM 541.980 <501 LA Euro4/5> Komp.Nr. 505108 /01	02.05-12.08	TNK	<b>0 414 799 005</b>	<b>0 986 445 002</b> <b>0 986 445 102</b>
			Komp.Nr. 505108/05	02.05-12.08	TNK	<b>0 414 799 015</b>	
<b>3248</b> BlueTec [MP2]	12,0	350	OM 541.978 <501 LA Euro4/5> Komp.Nr. 505108 /01	02.05-12.08	TNK	<b>0 414 799 005</b>	<b>0 986 445 002</b> <b>0 986 445 102</b>
			Komp.Nr. 505108/05	02.05-12.08	TNK	<b>0 414 799 015</b>	
<b>3332</b> [MP2]	12,0	235	OM 541.940 <501 LA Euro3> Komp.Nr. 505108 /05/06	04.03-12.08	TNK	<b>0 414 799 015</b>	
			Komp.Nr. 505108/01	04.03-12.08	TNK	<b>0 414 799 005</b>	<b>0 986 445 002</b> <b>0 986 445 102</b>
BlueTec [MP2]	12,0	235	OM 541.970 <501 LA Euro4/5> Komp.Nr. 505108 /01	02.05-12.08	TNK	<b>0 414 799 005</b>	<b>0 986 445 002</b> <b>0 986 445 102</b>
			Komp.Nr. 505108/05	02.05-12.08	TNK	<b>0 414 799 015</b>	





◀ MERCEDES-BENZ

<b>3336</b> [MP2]	12,0	265	OM 541.942 <501 LA Euro3> Komp.Nr. 505108/01	04.03-12.08	TNK	<b>0 414 799 005</b>	<b>0 986 445 002</b> <b>0 986 445 102</b>
			Komp.Nr. 505108/05	04.03-12.08	TNK	<b>0 414 799 015</b>	
BlueTec [MP2]	12,0	265	OM 541.972 <501 LA Euro4/5> Komp.Nr. 505108 /01	02.05-12.08	TNK	<b>0 414 799 005</b>	<b>0 986 445 002</b> <b>0 986 445 102</b>
			Komp.Nr. 505108/05	02.05-12.08	TNK	<b>0 414 799 015</b>	
<b>3341</b> [MP2]	12,0	300	OM 541.944 <501 LA Euro3> Komp.Nr. 505108/01	04.03-12.08	TNK	<b>0 414 799 005</b>	<b>0 986 445 002</b> <b>0 986 445 102</b>
			Komp.Nr. 505108/05	04.03-12.08	TNK	<b>0 414 799 015</b>	
BlueTec [MP2]	12,0	300	OM 541.974 <501 LA Euro4/5> Komp.Nr. 505108 /01	02.05-12.08	TNK	<b>0 414 799 005</b>	<b>0 986 445 002</b> <b>0 986 445 102</b>
			Komp.Nr. 505108/05	02.05-12.08	TNK	<b>0 414 799 015</b>	
<b>3344</b> [MP2]	12,0	320	OM 541.946 <501 LA Euro3> Komp.Nr. 505108/01	06.03-12.08	TNK	<b>0 414 799 005</b>	<b>0 986 445 002</b> <b>0 986 445 102</b>
			Komp.Nr. 505108/05	06.03-12.08	TNK	<b>0 414 799 015</b>	
BlueTec [MP2]	12,0	320	OM 541.976 <501 LA Euro4/5> Komp.Nr. 505108 /01	02.05-12.08	TNK	<b>0 414 799 005</b>	<b>0 986 445 002</b> <b>0 986 445 102</b>
			Komp.Nr. 505108/05	02.05-12.08	TNK	<b>0 414 799 015</b>	
<b>3346</b> [MP2]	12,0	335	OM 541... <501 LA Euro3> Komp.Nr. 505108/01	06.03-12.08	TNK	<b>0 414 799 005</b>	<b>0 986 445 002</b> <b>0 986 445 102</b>
			Komp.Nr. 505108/05	06.03-12.08	TNK	<b>0 414 799 015</b>	
BlueTec [MP2]	12,0	335	OM 541.980 <501 LA Euro4/5> Komp.Nr. 505108 /01	02.05-12.08	TNK	<b>0 414 799 005</b>	<b>0 986 445 002</b> <b>0 986 445 102</b>
			Komp.Nr. 505108/05	02.05-12.08	TNK	<b>0 414 799 015</b>	
<b>3348</b> BlueTec [MP2]	12,0	350	OM 541.978 <501 LA Euro4/5> Komp.Nr. 505108 /01	02.05-12.08	TNK	<b>0 414 799 005</b>	<b>0 986 445 002</b> <b>0 986 445 102</b>
			Komp.Nr. 505108/05	02.05-12.08	TNK	<b>0 414 799 015</b>	
<b>3350</b> [MP2]	15,9	370	OM 542.940 <502 LA Euro3>; OM 542.941 <502 LA Euro3> Komp.Nr. 505108 /01/02	04.03-12.08	TNK	<b>0 414 799 005</b>	<b>0 986 445 002</b> <b>0 986 445 102</b>
			Komp.Nr. 505108 /04	04.03-12.08	TNK	<b>0 414 799 007</b>	
			Komp.Nr. 505108 /06	04.03-12.08	TNK	<b>0 414 799 015</b>	
<b>3351</b> BlueTec [MP2]	15,9	375	OM 542.960 <502 LA Euro4/5> Komp.Nr. 505108 /02	02.05-12.08	TNK	<b>0 414 799 005</b>	<b>0 986 445 002</b> <b>0 986 445 102</b>
			Komp.Nr. 505108 /06	02.05-12.08	TNK	<b>0 414 799 015</b>	
<b>3354</b> [MP2]	15,9	395	OM 542.942 <502 LA Euro3> Komp.Nr. 505108 /01/02	04.03-12.08	TNK	<b>0 414 799 005</b>	<b>0 986 445 002</b> <b>0 986 445 102</b>
			Komp.Nr. 505108 /04	04.03-12.08	TNK	<b>0 414 799 007</b>	
			Komp.Nr. 505108 /06	04.03-12.08	TNK	<b>0 414 799 015</b>	
<b>3355</b> BlueTec [MP2]	15,9	405	OM 542.962 <502 LA Euro4/5> Komp.Nr. 505108 /02	07.05-12.08	TNK	<b>0 414 799 005</b>	<b>0 986 445 002</b> <b>0 986 445 102</b>
			Komp.Nr. 505108 /06	07.05-12.08	TNK	<b>0 414 799 015</b>	
<b>3358</b> [MP2]	15,9	425	OM 542.944 <502 LA Euro3> Komp.Nr. 505108 /01/02	04.03-12.08	TNK	<b>0 414 799 005</b>	<b>0 986 445 002</b> <b>0 986 445 102</b>
			Komp.Nr. 505108 /04	04.03-12.08	TNK	<b>0 414 799 007</b>	
			Komp.Nr. 505108 /06	04.03-12.08	TNK	<b>0 414 799 015</b>	





<b>3360</b> BlueTec [MP2]	15,9	440	OM 542.964 <502 LA Euro4/5>	09.06-12.08	TNK	<b>0 414 799 005</b>	<b>0 986 445 002</b>		
			Komp.Nr. 505108 /02				<b>0 986 445 102</b>		
			Komp.Nr. 505108 /06	09.06-12.08	TNK	<b>0 414 799 015</b>			
<b>4141</b> [MP2]	12,0	300	OM 541.944 <501 LA Euro3>	04.03-12.08	TNK	<b>0 414 799 005</b>	<b>0 986 445 002</b>		
			Komp.Nr. 505108/01				<b>0 986 445 102</b>		
			Komp.Nr. 505108/05	04.03-12.08	TNK	<b>0 414 799 015</b>			
BlueTec [MP2]	12,0	300	OM 541.974 <501 LA Euro4/5>	09.06-12.08	TNK	<b>0 414 799 005</b>	<b>0 986 445 002</b>		
			Komp.Nr. 505108 /01				<b>0 986 445 102</b>		
			Komp.Nr. 505108/05	09.06-12.08	TNK	<b>0 414 799 015</b>			
<b>4144</b> [MP2]	12,0	320	OM 541.946 <501 LA Euro3>	06.03-12.08	TNK	<b>0 414 799 005</b>	<b>0 986 445 002</b>		
			Komp.Nr. 505108/01				<b>0 986 445 102</b>		
			Komp.Nr. 505108/05	06.03-12.08	TNK	<b>0 414 799 015</b>			
BlueTec [MP2]	12,0	320	OM 541.976 <501 LA Euro4/5>	09.06-12.08	TNK	<b>0 414 799 005</b>	<b>0 986 445 002</b>		
			Komp.Nr. 505108 /01				<b>0 986 445 102</b>		
			Komp.Nr. 505108/05	09.06-12.08	TNK	<b>0 414 799 015</b>			
<b>4146</b> [MP2]	12,0	335	OM 541... <501 LA Euro3>	04.03-12.08	TNK	<b>0 414 799 005</b>	<b>0 986 445 002</b>		
			Komp.Nr. 505108/01				<b>0 986 445 102</b>		
			Komp.Nr. 505108/05	04.03-12.08	TNK	<b>0 414 799 015</b>			
BlueTec [MP2]	12,0	335	OM 541.980 <501 LA Euro4/5>	09.06-12.08	TNK	<b>0 414 799 005</b>	<b>0 986 445 002</b>		
			Komp.Nr. 505108 /01				<b>0 986 445 102</b>		
			Komp.Nr. 505108/05	09.06-12.08	TNK	<b>0 414 799 015</b>			
<b>4148</b> BlueTec [MP2]	12,0	350	OM 541.978 <501 LA Euro4/5>	09.06-12.08	TNK	<b>0 414 799 005</b>	<b>0 986 445 002</b>		
			Komp.Nr. 505108 /01				<b>0 986 445 102</b>		
			Komp.Nr. 505108/05	09.06-12.08	TNK	<b>0 414 799 015</b>			
<b>4150</b> [MP2]	15,9	370	OM 542.940 <502 LA Euro3>	04.03-12.08	TNK	<b>0 414 799 005</b>	<b>0 986 445 002</b>		
			Komp.Nr. 505108 /01/02				<b>0 986 445 102</b>		
			Komp.Nr. 505108 /04				04.03-12.08	TNK	<b>0 414 799 007</b>
			Komp.Nr. 505108 /06	04.03-12.08	TNK	<b>0 414 799 015</b>			
<b>4151</b> BlueTec [MP2]	15,9	375	OM 542.960 <502 LA Euro4/5>	09.06-12.08	TNK	<b>0 414 799 005</b>	<b>0 986 445 002</b>		
			Komp.Nr. 505108 /02				<b>0 986 445 102</b>		
			Komp.Nr. 505108 /06				09.06-12.08	TNK	<b>0 414 799 015</b>
<b>Actros III</b>									
<b>1832</b> AK BlueTec, BlueTec [MP3]	11,9	235	OM 541.996 <501 LA EEV>; OM 541.997 <501 LA EEV>	07.10→	TNK	<b>0 414 799 005</b>	<b>0 986 445 002</b>		
			Komp.Nr. 505108 /01				<b>0 986 445 102</b>		
			Komp.Nr. 505108/05				07.10→	TNK	<b>0 414 799 015</b>
			Komp.Nr. 505108/07				07.10→	TNK	<b>0 414 799 024</b>
			Komp.Nr. 505108/10	07.10→	TNK	<b>0 414 799 021</b>			
BlueTec [MP3]	11,9	235	OM 541.970 <501 LA Euro 4/5>	06.08→	TNK	<b>0 414 799 005</b>	<b>0 986 445 002</b>		
			Komp.Nr. 505108 /01				<b>0 986 445 102</b>		
			Komp.Nr. 505108/05	06.08→	TNK	<b>0 414 799 015</b>			
<b>1836</b> AK BlueTec [MP3]	11,9	265	OM 541.999 <501 LA EEV>	07.10→	TNK	<b>0 414 799 005</b>	<b>0 986 445 002</b>		
			Komp.Nr. 505108 /01				<b>0 986 445 102</b>		
			Komp.Nr. 505108/05				07.10→	TNK	<b>0 414 799 015</b>
			Komp.Nr. 505108/07				07.10→	TNK	<b>0 414 799 024</b>
			Komp.Nr. 505108/10	07.10→	TNK	<b>0 414 799 021</b>			
BlueTec [MP3]	11,9	265	OM 541.972 <501 LA Euro4/5>	06.08→	TNK	<b>0 414 799 005</b>	<b>0 986 445 002</b>		
			Komp.Nr. 505108 /01				<b>0 986 445 102</b>		
			Komp.Nr. 505108/05	06.08→	TNK	<b>0 414 799 015</b>			





◀ MERCEDES-BENZ

<b>1836</b> BlueTec [MP3]	11,9	265	OM 541.998 <501 LA EEV> Komp.Nr. 505108 /01	07.10→	TNK	<b>0 414 799 005</b>	<b>0 986 445 002</b> <b>0 986 445 102</b>
			Komp.Nr. 505108/06	07.10→	TNK	<b>0 414 799 015</b>	
			Komp.Nr. 505108/07	07.10→	TNK	<b>0 414 799 024</b>	
			Komp.Nr. 505108/10	07.10→	TNK	<b>0 414 799 021</b>	
<b>1841</b> AK BlueTec, BlueTec [MP3]	11,9	300	OM 541.990 <501 LA EEV>; OM 541.991 <501 LA EEV> Komp.Nr. 505108 /01	12.09→	TNK	<b>0 414 799 005</b>	<b>0 986 445 002</b> <b>0 986 445 102</b>
			Komp.Nr. 505108/05	12.09→	TNK	<b>0 414 799 015</b>	
			Komp.Nr. 505108/07	12.09→	TNK	<b>0 414 799 024</b>	
			Komp.Nr. 505108/10	12.09→	TNK	<b>0 414 799 021</b>	
BlueTec [MP3]	11,9	300	OM 541.974 <501 LA Euro4/5> Komp.Nr. 505108 /01	06.08→	TNK	<b>0 414 799 005</b>	<b>0 986 445 002</b> <b>0 986 445 102</b>
			Komp.Nr. 505108/05	06.08→	TNK	<b>0 414 799 015</b>	
<b>1844</b> AK BlueTec, BlueTec [MP3]	11,9	320	OM 541.992 <501 LA EEV>; OM 541.993 <501 LA EEV> Komp.Nr. 505108 /01	12.09→	TNK	<b>0 414 799 005</b>	<b>0 986 445 002</b> <b>0 986 445 102</b>
			Komp.Nr. 505108/05	12.09→	TNK	<b>0 414 799 015</b>	
			Komp.Nr. 505108/07	12.09→	TNK	<b>0 414 799 024</b>	
			Komp.Nr. 505108/10	12.09→	TNK	<b>0 414 799 021</b>	
BlueTec [MP3]	11,9	320	OM 541.976 <501 LA Euro4/5> Komp.Nr. 505108 /01	06.08→	TNK	<b>0 414 799 005</b>	<b>0 986 445 002</b> <b>0 986 445 102</b>
			Komp.Nr. 505108/05	06.08→	TNK	<b>0 414 799 015</b>	
<b>1846</b> AK BlueTec, BlueTec [MP3]	11,9	335	OM 541.994 <501 LA EEV>; OM 541.995 <501 LA EEV> Komp.Nr. 505108 /01	12.09→	TNK	<b>0 414 799 005</b>	<b>0 986 445 002</b> <b>0 986 445 102</b>
			Komp.Nr. 505108/05	12.09→	TNK	<b>0 414 799 015</b>	
			Komp.Nr. 505108/07	12.09→	TNK	<b>0 414 799 024</b>	
			Komp.Nr. 505108/10	12.09→	TNK	<b>0 414 799 021</b>	
BlueTec [MP3]	11,9	335	OM 541.980 <501 LA Euro4/5> Komp.Nr. 505108 /01	06.08→	TNK	<b>0 414 799 005</b>	<b>0 986 445 002</b> <b>0 986 445 102</b>
			Komp.Nr. 505108/05	06.08→	TNK	<b>0 414 799 015</b>	
<b>1848</b> BlueTec [MP3]	11,9	350	OM 541.978 <501 LA Euro4/5> Komp.Nr. 505108 /01	06.08→	TNK	<b>0 414 799 005</b>	<b>0 986 445 002</b> <b>0 986 445 102</b>
			Komp.Nr. 505108/05	06.08→	TNK	<b>0 414 799 015</b>	
<b>1851</b> BlueTec [MP3]	15,9	375	OM 542.960 <502 LA Euro4/5> Komp.Nr. 505108 /02	06.08→	TNK	<b>0 414 799 005</b>	<b>0 986 445 002</b> <b>0 986 445 102</b>
			Komp.Nr. 505108 /06	06.08→	TNK	<b>0 414 799 015</b>	
<b>1855</b> BlueTec [MP3]	15,9	405	OM 542.962 <502 LA Euro4/5> Komp.Nr. 505108 /02	06.08→	TNK	<b>0 414 799 005</b>	<b>0 986 445 002</b> <b>0 986 445 102</b>
			Komp.Nr. 505108 /06	06.08→	TNK	<b>0 414 799 015</b>	
<b>1860</b> BlueTec [MP3]	15,9	440	OM 542.964 <502 LA Euro4/5> Komp.Nr. 505108 /02	06.08→	TNK	<b>0 414 799 005</b>	<b>0 986 445 002</b> <b>0 986 445 102</b>
			Komp.Nr. 505108 /06	06.08→	TNK	<b>0 414 799 015</b>	
<b>2032</b> A/AK/AS BlueTec, BlueTec [MP3]	11,9	235	OM 541.996 <501 LA EEV>; OM 541.997 <501 LA EEV> Komp.Nr. 505108 /01	07.10→	TNK	<b>0 414 799 005</b>	<b>0 986 445 002</b> <b>0 986 445 102</b>
			Komp.Nr. 505108/05	07.10→	TNK	<b>0 414 799 015</b>	
			Komp.Nr. 505108/07	07.10→	TNK	<b>0 414 799 024</b>	
			Komp.Nr. 505108/10	07.10→	TNK	<b>0 414 799 021</b>	
BlueTec [MP3]	11,9	235	OM 541.970 <501 LA Euro4/5> Komp.Nr. 505108 /01	06.08→	TNK	<b>0 414 799 005</b>	<b>0 986 445 002</b> <b>0 986 445 102</b>
			Komp.Nr. 505108/05	06.08→	TNK	<b>0 414 799 015</b>	







<b>2036</b> A/AK/AS BlueTec [MP3]	11,9	265	OM 541.999 <501 LA EEV> Komp.Nr. 505108 /01	07.10→	TNK	<b>0 414 799 005</b>	<b>0 986 445 002</b> <b>0 986 445 102</b>
			Komp.Nr. 505108/05	07.10→	TNK	<b>0 414 799 015</b>	
			Komp.Nr. 505108/07	07.10→	TNK	<b>0 414 799 024</b>	
			Komp.Nr. 505108/10	07.10→	TNK	<b>0 414 799 021</b>	
BlueTec [MP3]	11,9	265	OM 541.972 <501 LA Euro4/5> Komp.Nr. 505108 /01	06.08→	TNK	<b>0 414 799 005</b>	<b>0 986 445 002</b> <b>0 986 445 102</b>
			Komp.Nr. 505108/05	06.08→	TNK	<b>0 414 799 015</b>	
			OM 541.998 <501 LA EEV> Komp.Nr. 505108 /01	07.10→	TNK	<b>0 414 799 005</b>	<b>0 986 445 002</b> <b>0 986 445 102</b>
			Komp.Nr. 505108 /06	07.10→	TNK	<b>0 414 799 015</b>	
			Komp.Nr. 505108/07	07.10→	TNK	<b>0 414 799 024</b>	
			Komp.Nr. 505108/10	07.10→	TNK	<b>0 414 799 021</b>	
<b>2041</b> AK/AS BlueTec, BlueTec [MP3]	11,9	300	OM 541.990 <501 LA EEV>; OM 541.991 <501 LA EEV> Komp.Nr. 505108 /01	12.09→	TNK	<b>0 414 799 005</b>	<b>0 986 445 002</b> <b>0 986 445 102</b>
			Komp.Nr. 505108/05	12.09→	TNK	<b>0 414 799 015</b>	
			Komp.Nr. 505108/07	12.09→	TNK	<b>0 414 799 024</b>	
			Komp.Nr. 505108/10	12.09→	TNK	<b>0 414 799 021</b>	
BlueTec [MP3]	11,9	300	OM 541.974 <501 LA Euro4/5> Komp.Nr. 505108 /01	06.08→	TNK	<b>0 414 799 005</b>	<b>0 986 445 002</b> <b>0 986 445 102</b>
			Komp.Nr. 505108/05	06.08→	TNK	<b>0 414 799 015</b>	
<b>2044</b> BlueTec [MP3]	11,9	320	OM 541.976 <501 LA Euro4/5> Komp.Nr. 505108 /01	06.08→	TNK	<b>0 414 799 005</b>	<b>0 986 445 002</b> <b>0 986 445 102</b>
			Komp.Nr. 505108/05	06.08→	TNK	<b>0 414 799 015</b>	
			OM 541.992 <501 LA EEV>; OM 541.993 <501 LA EEV> Komp.Nr. 505108 /01	12.09→	TNK	<b>0 414 799 005</b>	<b>0 986 445 002</b> <b>0 986 445 102</b>
			Komp.Nr. 505108/05	12.09→	TNK	<b>0 414 799 015</b>	
			Komp.Nr. 505108/07	12.09→	TNK	<b>0 414 799 024</b>	
			Komp.Nr. 505108/10	12.09→	TNK	<b>0 414 799 021</b>	
<b>2046</b> AK/AS BlueTec, BlueTec [MP3]	11,9	335	OM 541.994 <501 LA EEV>; OM 541.995 <501 LA EEV> Komp.Nr. 505108 /01	12.09→	TNK	<b>0 414 799 005</b>	<b>0 986 445 002</b> <b>0 986 445 102</b>
			Komp.Nr. 505108/05	12.09→	TNK	<b>0 414 799 015</b>	
			Komp.Nr. 505108/07	12.09→	TNK	<b>0 414 799 024</b>	
			Komp.Nr. 505108/10	12.09→	TNK	<b>0 414 799 021</b>	
BlueTec [MP3]	11,9	335	OM 541.980 <501 LA Euro4/5> Komp.Nr. 505108 /01	06.08→	TNK	<b>0 414 799 005</b>	<b>0 986 445 002</b> <b>0 986 445 102</b>
			Komp.Nr. 505108/05	06.08→	TNK	<b>0 414 799 015</b>	
<b>2048</b> BlueTec [MP3]	11,9	350	OM 541.978 <501 LA Euro4/5> Komp.Nr. 505108 /01	06.08→	TNK	<b>0 414 799 005</b>	<b>0 986 445 002</b> <b>0 986 445 102</b>
			Komp.Nr. 505108/05	06.08→	TNK	<b>0 414 799 015</b>	
<b>2051</b> BlueTec [MP3]	15,9	375	OM 542.960 <502 LA Euro4/5> Komp.Nr. 505108 /02	06.08→	TNK	<b>0 414 799 005</b>	<b>0 986 445 002</b> <b>0 986 445 102</b>
			Komp.Nr. 505108 /06	06.08→	TNK	<b>0 414 799 015</b>	
<b>2055</b> BlueTec [MP3]	15,9	405	OM 542.962 <502 LA Euro4/5> Komp.Nr. 505108 /02	06.08→	TNK	<b>0 414 799 005</b>	<b>0 986 445 002</b> <b>0 986 445 102</b>
			Komp.Nr. 505108 /06	06.08→	TNK	<b>0 414 799 015</b>	
<b>2432</b> BlueTec [MP3]	11,9	235	OM 541.970 <501 LA Euro4/5> Komp.Nr. 505108 /01	06.08→	TNK	<b>0 414 799 005</b>	<b>0 986 445 002</b> <b>0 986 445 102</b>
			Komp.Nr. 505108/05	06.08→	TNK	<b>0 414 799 015</b>	





◀ MERCEDES-BENZ

<b>2432</b> LS BlueTec [MP3]	11,9	235	OM 541.996 <501 LA EEV> Komp.Nr. 505108 /01	07.10→	TNK	<b>0 414 799 005</b>	<b>0 986 445 002</b>			
							<b>0 986 445 102</b>			
							Komp.Nr. 505108/05	07.10→	TNK	<b>0 414 799 015</b>
							Komp.Nr. 505108/07	07.10→	TNK	<b>0 414 799 024</b>
<b>2436</b> BlueTec [MP3]	11,9	265	OM 541.972 <501 LA Euro4/5> Komp.Nr. 505108 /01	06.08→	TNK	<b>0 414 799 005</b>	<b>0 986 445 002</b>			
							<b>0 986 445 102</b>			
LS BlueTec [MP3]	11,9	265	OM 541.998 <501 LA EEV> Komp.Nr. 505108 /01	07.10→	TNK	<b>0 414 799 005</b>	<b>0 986 445 002</b>			
							<b>0 986 445 102</b>			
Komp.Nr. 505108/05				06.08→	TNK	<b>0 414 799 015</b>				
							Komp.Nr. 505108/06	07.10→	TNK	<b>0 414 799 015</b>
Komp.Nr. 505108/07				07.10→	TNK	<b>0 414 799 024</b>				
							Komp.Nr. 505108/10	07.10→	TNK	<b>0 414 799 021</b>
<b>2441</b> BlueTec [MP3]	11,9	300	OM 541.974 <501 LA Euro4/5> Komp.Nr. 505108 /01	06.08→	TNK	<b>0 414 799 005</b>	<b>0 986 445 002</b>			
							<b>0 986 445 102</b>			
							Komp.Nr. 505108/05	06.08→	TNK	<b>0 414 799 015</b>
							LS BlueTec [MP3]	11,9	300	OM 541.990 <501 LA EEV> Komp.Nr. 505108 /01
<b>0 986 445 102</b>										
Komp.Nr. 505108/05				12.09→	TNK	<b>0 414 799 015</b>				
							Komp.Nr. 505108/07	12.09→	TNK	<b>0 414 799 024</b>
Komp.Nr. 505108/10				12.09→	TNK	<b>0 414 799 021</b>				
<b>2444</b> BlueTec [MP3]	11,9	320	OM 541.976 <501 LA Euro4/5> Komp.Nr. 505108 /01	06.08→	TNK	<b>0 414 799 005</b>	<b>0 986 445 002</b>			
							<b>0 986 445 102</b>			
							Komp.Nr. 505108/05	06.08→	TNK	<b>0 414 799 015</b>
							LS BlueTec [MP3]	11,9	320	OM 541.992 <501 LA EEV> Komp.Nr. 505108 /01
<b>0 986 445 102</b>										
Komp.Nr. 505108/05				12.09→	TNK	<b>0 414 799 015</b>				
							Komp.Nr. 505108/07	12.09→	TNK	<b>0 414 799 024</b>
Komp.Nr. 505108/10				12.09→	TNK	<b>0 414 799 021</b>				
<b>2446</b> BlueTec [MP3]	11,9	335	OM 541.980 <501 LA Euro4/5> Komp.Nr. 505108 /01	06.08→	TNK	<b>0 414 799 005</b>	<b>0 986 445 002</b>			
							<b>0 986 445 102</b>			
							Komp.Nr. 505108/05	06.08→	TNK	<b>0 414 799 015</b>
							<b>2448</b> BlueTec [MP3]	11,9	350	OM 541.978 <501 LA Euro4/5> Komp.Nr. 505108 /01
<b>0 986 445 102</b>										
Komp.Nr. 505108/05				06.08→	TNK	<b>0 414 799 015</b>				
							<b>2451</b> BlueTec [MP3]	15,9	375	OM 542.960 <502 LA Euro4/5> Komp.Nr. 505108 /02
<b>0 986 445 102</b>										
Komp.Nr. 505108/06				06.08→	TNK	<b>0 414 799 015</b>				
							<b>2455</b> BlueTec [MP3]	15,9	405	OM 542.962 <502 LA Euro4/5> Komp.Nr. 505108 /02
<b>0 986 445 102</b>										
Komp.Nr. 505108/06				06.08→	TNK	<b>0 414 799 015</b>				
							<b>2460</b> BlueTec [MP3]	15,9	440	OM 542.964 <502 LA Euro4/5> Komp.Nr. 505108 /02
<b>0 986 445 102</b>										
Komp.Nr. 505108/06				06.08→	TNK	<b>0 414 799 015</b>				
							<b>2532</b> BlueTec [MP3]	11,9	235	OM 541.970 <501 LA Euro4/5> Komp.Nr. 505108 /01
<b>0 986 445 102</b>										
Komp.Nr. 505108/05				06.08→	TNK	<b>0 414 799 015</b>				





<b>2532</b> BlueTec [MP3]	11,9	235	OM 541.996 <501 LA EEV>	07.10→	TNK	<b>0 414 799 005</b>	<b>0 986 445 002</b>					
			Komp.Nr. 505108 /01				<b>0 986 445 102</b>					
			Komp.Nr. 505108/05				07.10→	TNK	<b>0 414 799 015</b>			
			Komp.Nr. 505108/07				07.10→	TNK	<b>0 414 799 024</b>			
			Komp.Nr. 505108/10	07.10→	TNK	<b>0 414 799 021</b>						
<b>2536</b> BlueTec [MP3]	11,9	265	OM 541.972 <501 LA Euro4/5>	06.08→	TNK	<b>0 414 799 005</b>	<b>0 986 445 002</b>					
			Komp.Nr. 505108 /01				<b>0 986 445 102</b>					
			Komp.Nr. 505108/05				06.08→	TNK	<b>0 414 799 015</b>			
			OM 541.998 <501 LA EEV>				07.10→	TNK	<b>0 414 799 005</b>	<b>0 986 445 002</b>		
			Komp.Nr. 505108 /01							<b>0 986 445 102</b>		
			Komp.Nr. 505108 /06							07.10→	TNK	<b>0 414 799 015</b>
			Komp.Nr. 505108/07							07.10→	TNK	<b>0 414 799 024</b>
									Komp.Nr. 505108/10	07.10→	TNK	<b>0 414 799 021</b>
<b>2541</b> BlueTec [MP3]	11,9	300	OM 541.974 <501 LA Euro4/5>	06.08→	TNK	<b>0 414 799 005</b>	<b>0 986 445 002</b>					
			Komp.Nr. 505108 /01				<b>0 986 445 102</b>					
			Komp.Nr. 505108/05				06.08→	TNK	<b>0 414 799 015</b>			
			OM 541.990 <501 LA EEV>				12.09→	TNK	<b>0 414 799 005</b>	<b>0 986 445 002</b>		
			Komp.Nr. 505108 /01							<b>0 986 445 102</b>		
			Komp.Nr. 505108/05							12.09→	TNK	<b>0 414 799 015</b>
			Komp.Nr. 505108/07							12.09→	TNK	<b>0 414 799 024</b>
									Komp.Nr. 505108/10	12.09→	TNK	<b>0 414 799 021</b>
<b>2544</b> BlueTec [MP3]	11,9	320	OM 541.976 <501 LA Euro4/5>	06.08→	TNK	<b>0 414 799 005</b>	<b>0 986 445 002</b>					
			Komp.Nr. 505108 /01				<b>0 986 445 102</b>					
			Komp.Nr. 505108/05				06.08→	TNK	<b>0 414 799 015</b>			
			OM 541.992 <501 LA EEV>				12.09→	TNK	<b>0 414 799 005</b>	<b>0 986 445 002</b>		
			Komp.Nr. 505108 /01							<b>0 986 445 102</b>		
			Komp.Nr. 505108/05							12.09→	TNK	<b>0 414 799 015</b>
			Komp.Nr. 505108/07							12.09→	TNK	<b>0 414 799 024</b>
									Komp.Nr. 505108/10	12.09→	TNK	<b>0 414 799 021</b>
<b>2546</b> BlueTec [MP3]	11,9	335	OM 541.980 <501 LA Euro4/5>	06.08→	TNK	<b>0 414 799 005</b>	<b>0 986 445 002</b>					
			Komp.Nr. 505108 /01				<b>0 986 445 102</b>					
			Komp.Nr. 505108/05				06.08→	TNK	<b>0 414 799 015</b>			
			OM 541.994 <501 LA EEV>				12.09→	TNK	<b>0 414 799 005</b>	<b>0 986 445 002</b>		
			Komp.Nr. 505108 /01							<b>0 986 445 102</b>		
			Komp.Nr. 505108/05							12.09→	TNK	<b>0 414 799 015</b>
			Komp.Nr. 505108/07							12.09→	TNK	<b>0 414 799 024</b>
									Komp.Nr. 505108/10	12.09→	TNK	<b>0 414 799 021</b>
<b>2548</b> BlueTec [MP3]	11,9	350	OM 541.978 <501 LA Euro4/5>	06.08→	TNK	<b>0 414 799 005</b>	<b>0 986 445 002</b>					
			Komp.Nr. 505108 /01				<b>0 986 445 102</b>					
			Komp.Nr. 505108/05				06.08→	TNK	<b>0 414 799 015</b>			
<b>2551</b> BlueTec [MP3]	15,9	375	OM 542.960 <502 LA Euro4/5>	06.08→	TNK	<b>0 414 799 005</b>	<b>0 986 445 002</b>					
			Komp.Nr. 505108 /02				<b>0 986 445 102</b>					
			Komp.Nr. 505108 /06	06.08→	TNK	<b>0 414 799 015</b>						
<b>2555</b> BlueTec [MP3]	15,9	405	OM 542.962 <502 LA Euro4/5>	06.08→	TNK	<b>0 414 799 005</b>	<b>0 986 445 002</b>					
			Komp.Nr. 505108 /02				<b>0 986 445 102</b>					
			Komp.Nr. 505108 /06	06.08→	TNK	<b>0 414 799 015</b>						
<b>2560</b> BlueTec [MP3]	15,9	440	OM 542.964 <502 LA Euro4/5>	06.08→	TNK	<b>0 414 799 005</b>	<b>0 986 445 002</b>					
			Komp.Nr. 505108 /02				<b>0 986 445 102</b>					
			Komp.Nr. 505108 /06	06.08→	TNK	<b>0 414 799 015</b>						





◀ MERCEDES-BENZ

<b>2632</b> BlueTec [MP3]	11,9	235	OM 541.970 <501 LA Euro4/5>	06.08→	TNK	<b>0 414 799 005</b>	<b>0 986 445 002</b>			
			Komp.Nr. 505108 /01				<b>0 986 445 102</b>			
			Komp.Nr. 505108/05				06.08→	TNK	<b>0 414 799 015</b>	
			OM 541.996 <501 LA EEV>				07.10→	TNK	<b>0 414 799 005</b>	<b>0 986 445 002</b>
			Komp.Nr. 505108 /01							<b>0 986 445 102</b>
			Komp.Nr. 505108/05							<b>0 414 799 015</b>
Komp.Nr. 505108/07	<b>0 414 799 024</b>									
Komp.Nr. 505108/10	<b>0 414 799 021</b>									
<b>2636</b> BlueTec [MP3]	11,9	265	OM 541.972 <501 LA Euro4/5>	06.08→	TNK	<b>0 414 799 005</b>	<b>0 986 445 002</b>			
			Komp.Nr. 505108 /01				<b>0 986 445 102</b>			
			Komp.Nr. 505108/05				06.08→	TNK	<b>0 414 799 015</b>	
			OM 541.998 <501 LA EEV>				07.10→	TNK	<b>0 414 799 005</b>	<b>0 986 445 002</b>
			Komp.Nr. 505108 /01							<b>0 986 445 102</b>
			Komp.Nr. 505108 /06							<b>0 414 799 015</b>
Komp.Nr. 505108/07	<b>0 414 799 024</b>									
Komp.Nr. 505108/10	<b>0 414 799 021</b>									
<b>2641</b> BlueTec [MP3]	11,9	300	OM 541.974 <501 LA Euro4/5>	06.08→	TNK	<b>0 414 799 005</b>	<b>0 986 445 002</b>			
			Komp.Nr. 505108 /01				<b>0 986 445 102</b>			
			Komp.Nr. 505108/05				06.08→	TNK	<b>0 414 799 015</b>	
			OM 541.990 <501 LA EEV>				12.09→	TNK	<b>0 414 799 005</b>	<b>0 986 445 002</b>
			Komp.Nr. 505108 /01							<b>0 986 445 102</b>
			Komp.Nr. 505108/05							<b>0 414 799 015</b>
Komp.Nr. 505108/07	<b>0 414 799 024</b>									
Komp.Nr. 505108/10	<b>0 414 799 021</b>									
<b>2644</b> BlueTec [MP3]	11,9	320	OM 541.976 <501 LA Euro4/5>	06.08→	TNK	<b>0 414 799 005</b>	<b>0 986 445 002</b>			
			Komp.Nr. 505108 /01				<b>0 986 445 102</b>			
			Komp.Nr. 505108/05				06.08→	TNK	<b>0 414 799 015</b>	
			OM 541.992 <501 LA EEV>				12.09→	TNK	<b>0 414 799 005</b>	<b>0 986 445 002</b>
			Komp.Nr. 505108 /01							<b>0 986 445 102</b>
			Komp.Nr. 505108/05							<b>0 414 799 015</b>
Komp.Nr. 505108/07	<b>0 414 799 024</b>									
Komp.Nr. 505108/10	<b>0 414 799 021</b>									
<b>2646</b> BlueTec [MP3]	11,9	335	OM 541.980 <501 LA Euro4/5>	06.08→	TNK	<b>0 414 799 005</b>	<b>0 986 445 002</b>			
			Komp.Nr. 505108 /01				<b>0 986 445 102</b>			
			Komp.Nr. 505108/05				06.08→	TNK	<b>0 414 799 015</b>	
			OM 541.994 <501 LA EEV>				12.09→	TNK	<b>0 414 799 005</b>	<b>0 986 445 002</b>
			Komp.Nr. 505108 /01							<b>0 986 445 102</b>
			Komp.Nr. 505108/05							<b>0 414 799 015</b>
Komp.Nr. 505108/07	<b>0 414 799 024</b>									
Komp.Nr. 505108/10	<b>0 414 799 021</b>									
<b>2648</b> BlueTec [MP3]	11,9	350	OM 541.978 <501 LA Euro4/5>	06.08→	TNK	<b>0 414 799 005</b>	<b>0 986 445 002</b>			
			Komp.Nr. 505108 /01				<b>0 986 445 102</b>			
			Komp.Nr. 505108/05				06.08→	TNK	<b>0 414 799 015</b>	
			OM 542.960 <502 LA Euro4/5>				06.08→	TNK	<b>0 414 799 005</b>	<b>0 986 445 002</b>
			Komp.Nr. 505108 /02							<b>0 986 445 102</b>
			Komp.Nr. 505108 /06							<b>0 414 799 015</b>
Komp.Nr. 505108/07	<b>0 414 799 024</b>									
Komp.Nr. 505108/10	<b>0 414 799 021</b>									
<b>2651</b> BlueTec [MP3]	15,9	375	OM 542.960 <502 LA Euro4/5>	06.08→	TNK	<b>0 414 799 005</b>	<b>0 986 445 002</b>			
			Komp.Nr. 505108 /02				<b>0 986 445 102</b>			
<b>2655</b> BlueTec [MP3]	15,9	405	OM 542.962 <502 LA Euro4/5>	06.08→	TNK	<b>0 414 799 005</b>	<b>0 986 445 002</b>			
			Komp.Nr. 505108 /02				<b>0 986 445 102</b>			
			Komp.Nr. 505108 /06	06.08→	TNK	<b>0 414 799 015</b>				





<b>2660</b> BlueTec [MP3]	15,9	440	OM 542.964 <501 LA Euro4/5>	06.08→	TNK	<b>0 414 799 005</b>	<b>0 986 445 002</b>			
			Komp.Nr. 505108/02				<b>0 986 445 102</b>			
			Komp.Nr. 505108/06	06.08→	TNK	<b>0 414 799 015</b>				
<b>2732</b> AE/AKE BlueTec [MP3]	11,9	235	OM 541.971 <501 LA Euro 4/5>	06.08→	TNK	<b>0 414 799 005</b>	<b>0 986 445 002</b>			
			Komp.Nr. 505108/01				<b>0 986 445 102</b>			
			Komp.Nr. 505108/05	06.08→	TNK	<b>0 414 799 015</b>				
<b>2736</b> AE/AKE BlueTec [MP3]	11,9	265	OM 541.973 <501 LA Euro 4/5>	06.08→	TNK	<b>0 414 799 005</b>	<b>0 986 445 002</b>			
			Komp.Nr. 505108/01				<b>0 986 445 102</b>			
			Komp.Nr. 505108/05	06.08→	TNK	<b>0 414 799 015</b>				
<b>2741</b> AE/AKE BlueTec [MP3]	11,9	300	OM 541.975 <501 LA Euro 4/5>	06.08→	TNK	<b>0 414 799 005</b>	<b>0 986 445 002</b>			
			Komp.Nr. 505108/01				<b>0 986 445 102</b>			
			Komp.Nr. 505108/05	06.08→	TNK	<b>0 414 799 015</b>				
BlueTec [MP3]	11,9	300	OM 541.991 <501 LA EEV>	12.09→	TNK	<b>0 414 799 005</b>	<b>0 986 445 002</b>			
			Komp.Nr. 505108/01				<b>0 986 445 102</b>			
			Komp.Nr. 505108/05				<b>0 414 799 015</b>			
			Komp.Nr. 505108/07				<b>0 414 799 024</b>			
			Komp.Nr. 505108/10	12.09→	TNK	<b>0 414 799 021</b>				
<b>2744</b> AE/AKE BlueTec [MP3]	11,9	320	OM 541.977 <501 LA Euro 4/5>	06.08→	TNK	<b>0 414 799 005</b>	<b>0 986 445 002</b>			
			Komp.Nr. 505108/01				<b>0 986 445 102</b>			
			Komp.Nr. 505108/05	06.08→	TNK	<b>0 414 799 015</b>				
BlueTec [MP3]	11,9	320	OM 541.993 <501 LA EEV>	12.09→	TNK	<b>0 414 799 005</b>	<b>0 986 445 002</b>			
			Komp.Nr. 505108/01				<b>0 986 445 102</b>			
			Komp.Nr. 505108/05				<b>0 414 799 015</b>			
			Komp.Nr. 505108/07				<b>0 414 799 024</b>			
			Komp.Nr. 505108/10	12.09→	TNK	<b>0 414 799 021</b>				
<b>2746</b> AE/AKE BlueTec [MP3]	11,9	335	OM 541.981 <501 LA Euro 4/5>	06.08→	TNK	<b>0 414 799 005</b>	<b>0 986 445 002</b>			
			Komp.Nr. 505108/01				<b>0 986 445 102</b>			
			Komp.Nr. 505108/05	06.08→	TNK	<b>0 414 799 015</b>				
BlueTec [MP3]	11,9	335	OM 541.995 <501 LA EEV>	12.09→	TNK	<b>0 414 799 005</b>	<b>0 986 445 002</b>			
			Komp.Nr. 505108/01				<b>0 986 445 102</b>			
			Komp.Nr. 505108/05				<b>0 414 799 015</b>			
			Komp.Nr. 505108/07				<b>0 414 799 024</b>			
			Komp.Nr. 505108/10	12.09→	TNK	<b>0 414 799 021</b>				
<b>2748</b> AE/AKE BlueTec [MP3]	11,9	350	OM 541.979 <501 LA Euro 4/5>	06.08→	TNK	<b>0 414 799 005</b>	<b>0 986 445 002</b>			
			Komp.Nr. 505108/01				<b>0 986 445 102</b>			
			Komp.Nr. 505108/05	06.08→	TNK	<b>0 414 799 015</b>				
<b>3232</b> BlueTec [MP3]	11,9	235	OM 541.970 <501 LA Euro4/5>	06.08→	TNK	<b>0 414 799 005</b>	<b>0 986 445 002</b>			
			Komp.Nr. 505108/01				<b>0 986 445 102</b>			
			Komp.Nr. 505108/05				06.08→	TNK	<b>0 414 799 015</b>	
			OM 541.996 <501 LA EEV>				07.10→	TNK	<b>0 414 799 005</b>	<b>0 986 445 002</b>
			Komp.Nr. 505108/01							<b>0 986 445 102</b>
			Komp.Nr. 505108/05							<b>0 414 799 015</b>
			Komp.Nr. 505108/07	07.10→	TNK	<b>0 414 799 024</b>				
			Komp.Nr. 505108/10	07.10→	TNK	<b>0 414 799 021</b>				
<b>3236</b> BlueTec [MP3]	11,9	265	OM 541.972 <501 LA Euro4/5>	06.08→	TNK	<b>0 414 799 005</b>	<b>0 986 445 002</b>			
			Komp.Nr. 505108/01				<b>0 986 445 102</b>			
			Komp.Nr. 505108/05	06.08→	TNK	<b>0 414 799 015</b>				





◀ MERCEDES-BENZ

<b>3236</b> BlueTec [MP3]	11,9	265	OM 541.998 <501 LA EEV>	07.10→	TNK	<b>0 414 799 005</b>	<b>0 986 445 002</b>					
			Komp.Nr. 505108 /01				<b>0 986 445 102</b>					
			Komp.Nr. 505108 /06				07.10→	TNK	<b>0 414 799 015</b>			
			Komp.Nr. 505108 /07				07.10→	TNK	<b>0 414 799 024</b>			
			Komp.Nr. 505108 /10	07.10→	TNK	<b>0 414 799 021</b>						
<b>3241</b> BlueTec [MP3]	11,9	300	OM 541.974 <501 LA Euro4/5>	06.08→	TNK	<b>0 414 799 005</b>	<b>0 986 445 002</b>					
			Komp.Nr. 505108 /01				<b>0 986 445 102</b>					
			Komp.Nr. 505108 /05				06.08→	TNK	<b>0 414 799 015</b>			
			OM 541.990 <501 LA EEV>				12.09→	TNK	<b>0 414 799 005</b>	<b>0 986 445 002</b>		
			Komp.Nr. 505108 /01							<b>0 986 445 102</b>		
			Komp.Nr. 505108 /05							12.09→	TNK	<b>0 414 799 015</b>
			Komp.Nr. 505108 /07							12.09→	TNK	<b>0 414 799 024</b>
			Komp.Nr. 505108 /10	12.09→	TNK	<b>0 414 799 021</b>						
<b>3244</b> BlueTec [MP3]	11,9	320	OM 541.976 <501 LA Euro4/5>	06.08→	TNK	<b>0 414 799 005</b>	<b>0 986 445 002</b>					
			Komp.Nr. 505108 /01				<b>0 986 445 102</b>					
			Komp.Nr. 505108 /05				06.08→	TNK	<b>0 414 799 015</b>			
			OM 541.992 <501 LA EEV>				12.09→	TNK	<b>0 414 799 005</b>	<b>0 986 445 002</b>		
			Komp.Nr. 505108 /01							<b>0 986 445 102</b>		
			Komp.Nr. 505108 /05							12.09→	TNK	<b>0 414 799 015</b>
			Komp.Nr. 505108 /07							12.09→	TNK	<b>0 414 799 024</b>
			Komp.Nr. 505108 /10	12.09→	TNK	<b>0 414 799 021</b>						
<b>3246</b> BlueTec [MP3]	11,9	335	OM 541.980 <501 LA Euro4/5>	06.08→	TNK	<b>0 414 799 005</b>	<b>0 986 445 002</b>					
			Komp.Nr. 505108 /01				<b>0 986 445 102</b>					
			Komp.Nr. 505108 /05				06.08→	TNK	<b>0 414 799 015</b>			
			OM 541.994 <501 LA EEV>				12.09→	TNK	<b>0 414 799 005</b>	<b>0 986 445 002</b>		
			Komp.Nr. 505108 /01							<b>0 986 445 102</b>		
			Komp.Nr. 505108 /05							12.09→	TNK	<b>0 414 799 015</b>
			Komp.Nr. 505108 /07							12.09→	TNK	<b>0 414 799 024</b>
			Komp.Nr. 505108 /10	12.09→	TNK	<b>0 414 799 021</b>						
<b>3248</b> BlueTec [MP3]	11,9	350	OM 541.978 <501 LA Euro4/5>	06.08→	TNK	<b>0 414 799 005</b>	<b>0 986 445 002</b>					
			Komp.Nr. 505108 /01				<b>0 986 445 102</b>					
			Komp.Nr. 505108 /05				06.08→	TNK	<b>0 414 799 015</b>			
<b>3332</b> AK/AS BlueTec, BlueTec [MP3]	11,9	235	OM 541.996 <501 LA EEV>; OM 541.997 <501 LA EEV>	07.10→	TNK	<b>0 414 799 005</b>	<b>0 986 445 002</b>					
			Komp.Nr. 505108 /01				<b>0 986 445 102</b>					
			Komp.Nr. 505108 /05				07.10→	TNK	<b>0 414 799 015</b>			
			Komp.Nr. 505108 /07				07.10→	TNK	<b>0 414 799 024</b>			
			Komp.Nr. 505108 /10	07.10→	TNK	<b>0 414 799 021</b>						
BlueTec [MP3]	11,9	235	OM 541.970 <501 LA Euro4/5>	06.08→	TNK	<b>0 414 799 005</b>	<b>0 986 445 002</b>					
			Komp.Nr. 505108 /01				<b>0 986 445 102</b>					
			Komp.Nr. 505108 /05				06.08→	TNK	<b>0 414 799 015</b>			
<b>3336</b> AK/AS BlueTec [MP3]	11,9	265	OM 541.999 <501 LA EEV>	07.10→	TNK	<b>0 414 799 005</b>	<b>0 986 445 002</b>					
			Komp.Nr. 505108 /01				<b>0 986 445 102</b>					
			Komp.Nr. 505108 /05				07.10→	TNK	<b>0 414 799 015</b>			
			Komp.Nr. 505108 /07				07.10→	TNK	<b>0 414 799 024</b>			
			Komp.Nr. 505108 /10	07.10→	TNK	<b>0 414 799 021</b>						
BlueTec [MP3]	11,9	265	OM 541.972 <501 LA Euro4/5>	06.08→	TNK	<b>0 414 799 005</b>	<b>0 986 445 002</b>					
			Komp.Nr. 505108 /01				<b>0 986 445 102</b>					
			Komp.Nr. 505108 /05	06.08→	TNK	<b>0 414 799 015</b>						





<b>3336</b> BlueTec [MP3]	11,9	265	OM 541.998 <501 LA EEV>	07.10→	TNK	<b>0 414 799 005</b>	<b>0 986 445 002</b>			
			Komp.Nr. 505108 /01				<b>0 986 445 102</b>			
			Komp.Nr. 505108 /06				07.10→	TNK	<b>0 414 799 015</b>	
			Komp.Nr. 505108 /07				07.10→	TNK	<b>0 414 799 024</b>	
			Komp.Nr. 505108 /10	07.10→	TNK	<b>0 414 799 021</b>				
<b>3341</b> BlueTec [MP3]	11,9	300	OM 541.974 <501 LA Euro4/5>	06.08→	TNK	<b>0 414 799 005</b>	<b>0 986 445 002</b>			
			Komp.Nr. 505108 /01				<b>0 986 445 102</b>			
			Komp.Nr. 505108 /05				06.08→	TNK	<b>0 414 799 015</b>	
			OM 541.990 <501 LA EEV>; OM 541.991 <501 LA EEV>				12.09→	TNK	<b>0 414 799 005</b>	<b>0 986 445 002</b>
			Komp.Nr. 505108 /01							<b>0 986 445 102</b>
			Komp.Nr. 505108 /05							12.09→
			Komp.Nr. 505108 /07	12.09→	TNK	<b>0 414 799 024</b>				
			Komp.Nr. 505108 /10	12.09→	TNK	<b>0 414 799 021</b>				
<b>3344</b> A/AK/AS BlueTec, BlueTec [MP3]	11,9	320	OM 541.992 <501 LA EEV>; OM 541.993 <501 LA EEV>	12.09→	TNK	<b>0 414 799 005</b>	<b>0 986 445 002</b>			
			Komp.Nr. 505108 /01				<b>0 986 445 102</b>			
			Komp.Nr. 505108 /05				12.09→	TNK	<b>0 414 799 015</b>	
			Komp.Nr. 505108 /07				12.09→	TNK	<b>0 414 799 024</b>	
			Komp.Nr. 505108 /10	12.09→	TNK	<b>0 414 799 021</b>				
BlueTec [MP3]	11,9	320	OM 541.976 <501 LA Euro4/5>	06.08→	TNK	<b>0 414 799 005</b>	<b>0 986 445 002</b>			
			Komp.Nr. 505108 /01				<b>0 986 445 102</b>			
			Komp.Nr. 505108 /05	06.08→	TNK	<b>0 414 799 015</b>				
<b>3346</b> A/AK/AS BlueTec, BlueTec [MP3]	11,9	335	OM 541.994 <501 LA EEV>; OM 541.995 <501 LA EEV>	12.09→	TNK	<b>0 414 799 005</b>	<b>0 986 445 002</b>			
			Komp.Nr. 505108 /01				<b>0 986 445 102</b>			
			Komp.Nr. 505108 /05				12.09→	TNK	<b>0 414 799 015</b>	
			Komp.Nr. 505108 /07				12.09→	TNK	<b>0 414 799 024</b>	
			Komp.Nr. 505108 /10	12.09→	TNK	<b>0 414 799 021</b>				
BlueTec [MP3]	11,9	335	OM 541.980 <501 LA Euro4/5>	06.08→	TNK	<b>0 414 799 005</b>	<b>0 986 445 002</b>			
			Komp.Nr. 505108 /01				<b>0 986 445 102</b>			
			Komp.Nr. 505108 /05	06.08→	TNK	<b>0 414 799 015</b>				
<b>3348</b> BlueTec [MP3]	11,9	350	OM 541.978 <501 LA Euro4/5>	06.08→	TNK	<b>0 414 799 005</b>	<b>0 986 445 002</b>			
			Komp.Nr. 505108 /01				<b>0 986 445 102</b>			
			Komp.Nr. 505108 /05	06.08→	TNK	<b>0 414 799 015</b>				
<b>3351</b> BlueTec [MP3]	15,9	375	OM 542.960 <502 LA Euro4/5>	06.08→	TNK	<b>0 414 799 005</b>	<b>0 986 445 002</b>			
			Komp.Nr. 505108 /02				<b>0 986 445 102</b>			
			Komp.Nr. 505108 /06	06.08→	TNK	<b>0 414 799 015</b>				
<b>3355</b> BlueTec [MP3]	15,9	405	OM 542.962 <502 LA Euro4/5>	06.08→	TNK	<b>0 414 799 005</b>	<b>0 986 445 002</b>			
			Komp.Nr. 505108 /02				<b>0 986 445 102</b>			
			Komp.Nr. 505108 /06	06.08→	TNK	<b>0 414 799 015</b>				
<b>3360</b> BlueTec [MP3]	15,9	440	OM 542.964 <502 LA Euro4/5>	06.08→	TNK	<b>0 414 799 005</b>	<b>0 986 445 002</b>			
			Komp.Nr. 505108 /02				<b>0 986 445 102</b>			
			Komp.Nr. 505108 /06	06.08→	TNK	<b>0 414 799 015</b>				
<b>3641</b> AKE BlueTec [MP3]	11,9	300	OM 541.991 <501 LA EEV>	12.09→	TNK	<b>0 414 799 005</b>	<b>0 986 445 002</b>			
			Komp.Nr. 505108 /01				<b>0 986 445 102</b>			
			Komp.Nr. 505108 /05				12.09→	TNK	<b>0 414 799 015</b>	
			Komp.Nr. 505108 /07				12.09→	TNK	<b>0 414 799 024</b>	
			Komp.Nr. 505108 /10	12.09→	TNK	<b>0 414 799 021</b>				





◀ MERCEDES-BENZ

<b>3644</b> AKE BlueTec [MP3]	11,9	320	OM 541.993 <501 LA EEV> Komp.Nr. 505108 /01	12.09→	TNK	<b>0 414 799 005</b>	<b>0 986 445 002</b> <b>0 986 445 102</b>
			Komp.Nr. 505108/05	12.09→	TNK	<b>0 414 799 015</b>	
			Komp.Nr. 505108/07	12.09→	TNK	<b>0 414 799 024</b>	
			Komp.Nr. 505108/10	12.09→	TNK	<b>0 414 799 021</b>	
<b>4141</b> AK BlueTec, BlueTec [MP3]	11,9	300	OM 541.990 <501 LA EEV>; OM 541.991 <501 LA EEV> Komp.Nr. 505108 /01	12.09→	TNK	<b>0 414 799 005</b>	<b>0 986 445 002</b> <b>0 986 445 102</b>
			Komp.Nr. 505108/05	12.09→	TNK	<b>0 414 799 015</b>	
			Komp.Nr. 505108/07	12.09→	TNK	<b>0 414 799 024</b>	
			Komp.Nr. 505108/10	12.09→	TNK	<b>0 414 799 021</b>	
BlueTec [MP3]	11,9	300	OM 541.974 <501 LA Euro4/5> Komp.Nr. 505108 /01	06.08→	TNK	<b>0 414 799 005</b>	<b>0 986 445 002</b> <b>0 986 445 102</b>
			Komp.Nr. 505108/05	06.08→	TNK	<b>0 414 799 015</b>	
<b>4144</b> AK BlueTec, BlueTec [MP3]	11,9	320	OM 541.992 <501 LA EEV>; OM 541.993 <501 LA EEV> Komp.Nr. 505108 /01	12.09→	TNK	<b>0 414 799 005</b>	<b>0 986 445 002</b> <b>0 986 445 102</b>
			Komp.Nr. 505108/05	12.09→	TNK	<b>0 414 799 015</b>	
			Komp.Nr. 505108/07	12.09→	TNK	<b>0 414 799 024</b>	
			Komp.Nr. 505108/10	12.09→	TNK	<b>0 414 799 021</b>	
BlueTec [MP3]	11,9	320	OM 541.976 <501 LA Euro4/5> Komp.Nr. 505108 /01	06.08→	TNK	<b>0 414 799 005</b>	<b>0 986 445 002</b> <b>0 986 445 102</b>
			Komp.Nr. 505108/05	06.08→	TNK	<b>0 414 799 015</b>	
<b>4146</b> BlueTec [MP3]	11,9	335	OM 541.980 <501 LA Euro4/5> Komp.Nr. 505108 /01	06.08→	TNK	<b>0 414 799 005</b>	<b>0 986 445 002</b> <b>0 986 445 102</b>
			Komp.Nr. 505108/05	06.08→	TNK	<b>0 414 799 015</b>	
			OM 541.994 <501 LA EEV> Komp.Nr. 505108 /01	12.09→	TNK	<b>0 414 799 005</b>	<b>0 986 445 002</b> <b>0 986 445 102</b>
			Komp.Nr. 505108/05	12.09→	TNK	<b>0 414 799 015</b>	
			Komp.Nr. 505108/07	12.09→	TNK	<b>0 414 799 024</b>	
			Komp.Nr. 505108/10	12.09→	TNK	<b>0 414 799 021</b>	
<b>4148</b> BlueTec [MP3]	11,9	350	OM 541.978 <501 LA Euro4/5> Komp.Nr. 505108 /01	06.08→	TNK	<b>0 414 799 005</b>	<b>0 986 445 002</b> <b>0 986 445 102</b>
			Komp.Nr. 505108/05	06.08→	TNK	<b>0 414 799 015</b>	
<b>4151</b> BlueTec [MP3]	15,9	375	OM 542.960 <502 LA Euro4/5> Komp.Nr. 505108 /02	06.08→	TNK	<b>0 414 799 005</b>	<b>0 986 445 002</b> <b>0 986 445 102</b>
			Komp.Nr. 505108 /06	06.08→	TNK	<b>0 414 799 015</b>	
<b>4155</b> BlueTec [MP3]	15,9	405	OM 542.962 <502 LA Euro4/5> Komp.Nr. 505108 /02	06.08→	TNK	<b>0 414 799 005</b>	<b>0 986 445 002</b> <b>0 986 445 102</b>
			Komp.Nr. 505108 /06	06.08→	TNK	<b>0 414 799 015</b>	
<b>4160</b> BlueTec [MP3]	15,9	440	OM 542.964 <502 LA Euro4/5> Komp.Nr. 505108 /02	06.08→	TNK	<b>0 414 799 005</b>	<b>0 986 445 002</b> <b>0 986 445 102</b>
			Komp.Nr. 505108 /06	06.08→	TNK	<b>0 414 799 015</b>	
<b>Atego</b>							
<b>712</b> [LKN]	4,3	90	OM 904.909 LA <Euro2>; OM 904.915 LA <Euro 3>	01.98-09.04		<b>0 414 799 008</b>	<b>0 986 445 003</b> <b>0 986 445 103</b>
<b>714</b> , L [LKN]	4,3	100	OM 904.910 LA <Euro2>; OM 904.916 LA <Euro 3>	01.98-09.04		<b>0 414 799 008</b>	<b>0 986 445 003</b> <b>0 986 445 103</b>
<b>715</b> [LKN]	4,3	110	OM 904.950 LA <Euro 3> Komp.Nr. 505012/05	09.00-09.04	TNK	<b>0 414 799 008</b>	<b>0 986 445 003</b> <b>0 986 445 103</b>
			Komp.Nr. 505012/17	09.00-09.04	TNK	<b>0 414 799 014</b>	







<b>715</b> , L [LKN]	4,3	112	OM 904.922 LA <Euro2> Komp.Nr. 505012/05	01.98-09.04 TNK	<b>0 414 799 008</b>	<b>0 986 445 003</b> <b>0 986 445 103</b>
<b>717</b> , L [LKN]	4,3	125	OM 904.911 LA <Euro2>; OM 904.917 LA <Euro 3>	01.98-09.04	<b>0 414 799 008</b>	<b>0 986 445 003</b> <b>0 986 445 103</b>
<b>812</b> [LKN]	4,3	90	OM 904.909 LA <Euro 3>	01.98-10.04	<b>0 414 799 008</b>	<b>0 986 445 003</b> <b>0 986 445 103</b>
<b>814</b> , L [LKN]	4,3	100	OM 904.910 LA <Euro2>; OM 904.916 LA <Euro3>	01.98-09.04	<b>0 414 799 008</b>	<b>0 986 445 003</b> <b>0 986 445 103</b>
<b>815</b> [LKN]	4,3	110	OM 904.950 LA <Euro 3> Komp.Nr. 505012/05	09.00-09.04 TNK	<b>0 414 799 008</b>	<b>0 986 445 003</b> <b>0 986 445 103</b>
			Komp.Nr. 505012/17	09.00-09.04 TNK	<b>0 414 799 014</b>	
, F, L [LKN]	4,3	112	OM 904.922 LA <Euro2> Komp.Nr. 505012/05	01.98-09.04 TNK	<b>0 414 799 008</b>	<b>0 986 445 003</b> <b>0 986 445 103</b>
<b>817</b> , L [LKN]	4,3	125	OM 904.911 LA <Euro2>	01.98-09.04	<b>0 414 799 008</b>	<b>0 986 445 003</b> <b>0 986 445 103</b>
F [LKN]	4,3	112	OM 904.922 LA <Euro2> Komp.Nr. 505012/05	01.98-09.04 TNK	<b>0 414 799 008</b>	<b>0 986 445 003</b> <b>0 986 445 103</b>
<b>818</b> [LKN]	4,3	130	OM 904.951 LA <Euro 3> Komp.Nr. 505012/05	09.00-09.04 TNK	<b>0 414 799 008</b>	<b>0 986 445 003</b> <b>0 986 445 103</b>
			Komp.Nr. 505012/17	09.00-09.04 TNK	<b>0 414 799 014</b>	
<b>823</b> [LKN]	6,4	170	OM 906.925 LA <Euro 3>	09.00-09.04	<b>0 414 799 008</b>	<b>0 986 445 003</b> <b>0 986 445 103</b>
			Komp.Nr. 505012/14	09.00-09.04 TNK	<b>0 414 799 014</b>	
, L [LKN]	6,4	170	OM 906.910 LA <Euro2>	01.98-09.04	<b>0 414 799 008</b>	<b>0 986 445 003</b> <b>0 986 445 103</b>
<b>915</b> [LKN]	4,3	110	OM 904.950 LA <Euro 3> Komp.Nr. 505012/05	09.00-09.04 TNK	<b>0 414 799 008</b>	<b>0 986 445 003</b> <b>0 986 445 103</b>
			Komp.Nr. 505012/17	09.00-09.04 TNK	<b>0 414 799 014</b>	
AF [LKN]	4,3	125	OM 904.911 LA <Euro2>	01.98-09.04	<b>0 414 799 008</b>	<b>0 986 445 003</b> <b>0 986 445 103</b>
<b>917</b> , KO, L [LKN]	4,3	125-128	OM 904... <Euro3>; OM 904.911 LA <Euro2>	01.98-09.04	<b>0 414 799 008</b>	<b>0 986 445 003</b> <b>0 986 445 103</b>
<b>918</b> [LKN]	4,3	130	OM 904.951 LA <Euro3> Komp.Nr. 505012/05	09.00-09.04 TNK	<b>0 414 799 008</b>	<b>0 986 445 003</b> <b>0 986 445 103</b>
			Komp.Nr. 505012/17	09.00-09.04 TNK	<b>0 414 799 014</b>	
<b>923</b> [LKN]	6,4	170	OM 906.925 LA <Euro 3>	09.00-09.04	<b>0 414 799 008</b>	<b>0 986 445 003</b> <b>0 986 445 103</b>
			Komp.Nr. 505012/14	09.00-09.04 TNK	<b>0 414 799 014</b>	
, L [LKN]	6,4	170	OM 906.910 LA <Euro2>	01.98-09.04	<b>0 414 799 008</b>	<b>0 986 445 003</b> <b>0 986 445 103</b>
<b>925 AF</b> [LKN]	6,4	180	OM 906... <Euro 2/3>	01.98-09.04	<b>0 414 799 008</b>	<b>0 986 445 003</b> <b>0 986 445 103</b>
<b>1015</b> [LKN]	4,3	110	OM 904.950 LA <Euro 3> Komp.Nr. 505012/05	09.00-09.04 TNK	<b>0 414 799 008</b>	<b>0 986 445 003</b> <b>0 986 445 103</b>
			Komp.Nr. 505012/17	09.00-09.04 TNK	<b>0 414 799 014</b>	
<b>1017</b> , A, AK, KO, L [LKN]	4,3	125	OM 904.911 LA <Euro2>	01.98-09.04	<b>0 414 799 008</b>	<b>0 986 445 003</b> <b>0 986 445 103</b>
<b>1018</b> [LKN]	4,3	130	OM 904.951 LA <Euro 3> Komp.Nr. 505012/05	09.00-09.04 TNK	<b>0 414 799 008</b>	<b>0 986 445 003</b> <b>0 986 445 103</b>
			Komp.Nr. 505012/17	09.00-09.04 TNK	<b>0 414 799 014</b>	
<b>1023</b> [LKN]	6,4	170	OM 906.925 LA <Euro3>	09.00-09.04	<b>0 414 799 008</b>	<b>0 986 445 003</b> <b>0 986 445 103</b>
			Komp.Nr. 505012/14	09.00-09.04 TNK	<b>0 414 799 014</b>	





◀ MERCEDES-BENZ

<b>1023</b> , L [LKN]	6,4	170	OM 906.910 LA <Euro2>	01.98-09.04	<b>0 414 799 008</b>	<b>0 986 445 003</b> <b>0 986 445 103</b>
<b>1214</b> , L [LKN]	4,3	100	OM 904.910 LA <Euro2>	01.98-09.04	<b>0 414 799 008</b>	<b>0 986 445 003</b> <b>0 986 445 103</b>
<b>1215</b> [LKN]	4,3	110	OM 904.950 LA <Euro 3> Komp.Nr. 505012/05	09.00-09.04 TNK	<b>0 414 799 008</b>	<b>0 986 445 003</b> <b>0 986 445 103</b>
			Komp.Nr. 505012/17	09.00-09.04 TNK	<b>0 414 799 014</b>	
, L [LKN]	4,3	112	OM 904.922 LA <Euro2> Komp.Nr. 505012/05	01.98-09.04 TNK	<b>0 414 799 008</b>	<b>0 986 445 003</b> <b>0 986 445 103</b>
<b>1217</b> , KO, L [LKN]	4,3	125	OM 904.911 LA <Euro2>	01.98-09.04	<b>0 414 799 008</b>	<b>0 986 445 003</b> <b>0 986 445 103</b>
<b>1218</b> [LKN]	4,3	130	OM 904.951 LA <Euro 3> Komp.Nr. 505012/05	09.00-09.04 TNK	<b>0 414 799 008</b>	<b>0 986 445 003</b> <b>0 986 445 103</b>
			Komp.Nr. 505012/17	09.00-09.04 TNK	<b>0 414 799 014</b>	
<b>1223</b> [LKN]	6,4	170	OM 906.925 LA <Euro3>	09.00-09.04	<b>0 414 799 008</b>	<b>0 986 445 003</b> <b>0 986 445 103</b>
			Komp.Nr. 505012/14	09.00-09.04 TNK	<b>0 414 799 014</b>	
, L [LKN]	6,4	170	OM 906.910 LA <Euro2>	01.98-09.04	<b>0 414 799 008</b>	<b>0 986 445 003</b> <b>0 986 445 103</b>
<b>1225 AF</b> , F [LKN]	6,4	180	OM 906... <Euro 2/3>	01.98-09.04	<b>0 414 799 008</b>	<b>0 986 445 003</b> <b>0 986 445 103</b>
<b>1228</b> [LKN]	6,4	205	OM 906.926 LA <Euro3>	09.00-10.04	<b>0 414 799 008</b>	<b>0 986 445 003</b> <b>0 986 445 103</b>
			Komp.Nr. 505012/14	09.00-10.04 TNK	<b>0 414 799 014</b>	
, L [LKN]	6,4	205	OM 906.911 LA <Euro2>	01.98-09.04	<b>0 414 799 008</b>	<b>0 986 445 003</b> <b>0 986 445 103</b>
<b>1317</b> , A, AK, KO, L [LKN]	4,3	125	OM 904.911 LA <Euro2>	01.98->	<b>0 414 799 008</b>	<b>0 986 445 003</b> <b>0 986 445 103</b>
<b>1318</b> [LKN]	4,3	130	OM 904.951 LA <Euro 3> Komp.Nr. 505012/05	09.00-09.04 TNK	<b>0 414 799 008</b>	<b>0 986 445 003</b> <b>0 986 445 103</b>
			Komp.Nr. 505012/17	09.00-09.04 TNK	<b>0 414 799 014</b>	
<b>1323</b> , L, LKO [LKN]	6,4	170	OM 906.910 LA <Euro2>	01.98-09.04	<b>0 414 799 008</b>	<b>0 986 445 003</b> <b>0 986 445 103</b>
<b>1325 AF</b> , F [LKN]	6,4	180	OM 906... <Euro 2/3>	01.98-09.04	<b>0 414 799 008</b>	<b>0 986 445 003</b> <b>0 986 445 103</b>
<b>1328</b> [LKN]	6,4	205	OM 906.926 LA <Euro3>	09.00-09.04	<b>0 414 799 008</b>	<b>0 986 445 003</b> <b>0 986 445 103</b>
			Komp.Nr. 505012/14	09.00-09.04 TNK	<b>0 414 799 014</b>	
, AF, F, L [LKN]	6,4	205	OM 906.911 LA <Euro2>	01.98-09.04	<b>0 414 799 008</b>	<b>0 986 445 003</b> <b>0 986 445 103</b>
<b>1517</b> , L [LKN]	4,3	125	OM 904.911 LA <Euro2>	01.98-09.04	<b>0 414 799 008</b>	<b>0 986 445 003</b> <b>0 986 445 103</b>
<b>1518</b> [LKN]	4,3	130	OM 904.951 LA <Euro 3> Komp.Nr. 505012/05	09.00-09.04 TNK	<b>0 414 799 008</b>	<b>0 986 445 003</b> <b>0 986 445 103</b>
			Komp.Nr. 505012/17	09.00-09.04 TNK	<b>0 414 799 014</b>	
<b>1523</b> [LKN]	6,4	170	OM 906.925 LA <Euro3>	09.00-10.04	<b>0 414 799 008</b>	<b>0 986 445 003</b> <b>0 986 445 103</b>
			Komp.Nr. 505012/14	09.00-10.04 TNK	<b>0 414 799 014</b>	
, A, AK, KO, L [LKN]	6,4	170	OM 906.910 LA <Euro2>	01.98-09.04	<b>0 414 799 008</b>	<b>0 986 445 003</b> <b>0 986 445 103</b>
<b>1525 AF</b> [LKN]	6,4	180	OM 906... <Euro 2/3>	01.98-09.04	<b>0 414 799 008</b>	<b>0 986 445 003</b> <b>0 986 445 103</b>
<b>1528</b> [LKN]	6,4	205	OM 906.926 LA <Euro3>	09.00-09.04	<b>0 414 799 008</b>	<b>0 986 445 003</b> <b>0 986 445 103</b>
			Komp.Nr. 505012/14	09.00-09.04 TNK	<b>0 414 799 014</b>	
, AF, F, L [LKN]	6,4	205	OM 906.911 LA <Euro2>	01.98-09.04	<b>0 414 799 008</b>	<b>0 986 445 003</b> <b>0 986 445 103</b>





<b>1823</b> [LKN]	6,4	170	OM 906.925 LA <Euro3>	09.00-09.04	<b>0 414 799 008</b>	<b>0 986 445 003</b>
			Komp.Nr. 505012/14	09.00-09.04 TNK	<b>0 414 799 014</b>	<b>0 986 445 103</b>
, AK, K, L, LS [LKN]	6,4	170	OM 906.920 LA <Euro2>; OM 906.922 LA <Euro2>			
			Komp.Nr. 505012/05/06	05.98-09.04 TNK	<b>0 414 799 008</b>	<b>0 986 445 003</b>
			Komp.Nr. 505012/14	05.98-09.04 TNK	<b>0 414 799 014</b>	<b>0 986 445 103</b>
<b>1828</b> [LKN]	6,4	205	OM 906.926 LA <Euro3>	09.00-09.04	<b>0 414 799 008</b>	<b>0 986 445 003</b>
			Komp.Nr. 505012/14	09.00-09.04 TNK	<b>0 414 799 014</b>	<b>0 986 445 103</b>
, A, AK, K, L, LS [LKN]	6,4	205	OM 906.921 LA <Euro2>; OM 906.923 LA <Euro2>			
			Komp.Nr. 505012/05/06	05.98-09.04 TNK	<b>0 414 799 008</b>	<b>0 986 445 003</b>
			Komp.Nr. 505012/14	05.98-09.04 TNK	<b>0 414 799 014</b>	<b>0 986 445 103</b>
<b>1833</b> [LKN]	7,2	240	OM 926.913 LA <Euro3>			
			Komp.Nr. 505012/05/06	09.00-09.04 TNK	<b>0 414 799 008</b>	<b>0 986 445 003</b>
			Komp.Nr. 505012/14	09.00-09.04 TNK	<b>0 414 799 014</b>	<b>0 986 445 103</b>
<b>2523</b> L [LKN]	6,4	170	OM 906.920 LA <Euro2>			
			Komp.Nr. 505012/05/06	05.98-09.04 TNK	<b>0 414 799 008</b>	<b>0 986 445 003</b>
			Komp.Nr. 505012/14	05.98-09.04 TNK	<b>0 414 799 014</b>	<b>0 986 445 103</b>
<b>2528</b> [LKN]	6,4	205	OM 906.926 LA <Euro3>	09.00-09.04	<b>0 414 799 008</b>	<b>0 986 445 003</b>
			Komp.Nr. 505012/14	09.00-09.04 TNK	<b>0 414 799 014</b>	<b>0 986 445 103</b>
L [LKN]	6,4	205	OM 906.921 LA <Euro2>			
			Komp.Nr. 505012/05/06	05.98-09.04 TNK	<b>0 414 799 008</b>	<b>0 986 445 003</b>
			Komp.Nr. 505012/14	05.98-09.04 TNK	<b>0 414 799 014</b>	<b>0 986 445 103</b>
<b>2533</b> [LKN]	7,2	240	OM 926.913 LA <Euro3>			
			Komp.Nr. 505012/05/06	09.00-09.04 TNK	<b>0 414 799 008</b>	<b>0 986 445 003</b>
			Komp.Nr. 505012/14	09.00-09.04 TNK	<b>0 414 799 014</b>	<b>0 986 445 103</b>
<b>2628</b> [LKN]	6,4	205	OM 906.926 LA <Euro3>	09.00-09.04	<b>0 414 799 008</b>	<b>0 986 445 003</b>
			Komp.Nr. 505012/14	09.00-09.04 TNK	<b>0 414 799 014</b>	<b>0 986 445 103</b>
, B, K [LKN]	6,4	205	OM 906.921 LA <Euro2>			
			Komp.Nr. 505012/05/06	05.98-09.04 TNK	<b>0 414 799 008</b>	<b>0 986 445 003</b>
			Komp.Nr. 505012/14	05.98-09.04 TNK	<b>0 414 799 014</b>	<b>0 986 445 103</b>
<b>2633</b> [LKN]	7,2	240	OM 926.913 LA <Euro3>			
			Komp.Nr. 505012/05/06	09.00-09.04 TNK	<b>0 414 799 008</b>	<b>0 986 445 003</b>
			Komp.Nr. 505012/14	09.00-09.04 TNK	<b>0 414 799 014</b>	<b>0 986 445 103</b>
<b>Atego II</b>						
<b>713</b> BlueTec	4,3	95	OM 900.911 <(904 LA) Euro 4>	02.06→	<b>0 414 799 008</b>	<b>0 986 445 003</b>
						<b>0 986 445 103</b>
<b>716</b> BlueTec	4,3	115	OM 900... <Euro 4/5>			
			Mot. Typ 900.912	02.06→	<b>0 414 799 008</b>	<b>0 986 445 003</b>
			Mot. Typ 924.935	02.06→	<b>0 414 799 017</b>	<b>0 986 445 103</b>
<b>813</b> BlueTec	4,3	95	OM 900.911 <(904 LA) Euro 4>	02.06→	<b>0 414 799 008</b>	<b>0 986 445 003</b>
						<b>0 986 445 103</b>
<b>816</b> BlueTec	4,3	115	OM 900... <Euro 4/5>			
			Mot. Typ 900.912	02.06→	<b>0 414 799 008</b>	<b>0 986 445 003</b>
			Mot. Typ 924.935	02.06→	<b>0 414 799 017</b>	<b>0 986 445 103</b>
<b>818</b> BlueTec	4,3	130	OM 900.913 <(904) Euro 4>	02.06→	<b>0 414 799 008</b>	<b>0 986 445 003</b>
						<b>0 986 445 103</b>
<b>822</b>	4,8	160	OM 924.920 <Euro 3>	09.04→	<b>0 414 799 008</b>	<b>0 986 445 003</b>
						<b>0 986 445 103</b>
BlueTec	4,8	160	OM 924.922 LA <Euro 4>	06.06→	<b>0 414 799 012</b>	
			OM 924.930 LA <Euro 5/EEV>	06.06→	<b>0 414 799 017</b>	





◀ MERCEDES-BENZ

<b>823</b>	6,4	170	OM 906.915 <Euro 3>	09.04→	<b>0 414 799 008</b>	<b>0 986 445 003</b> <b>0 986 445 103</b>
<b>824</b> BlueTec	6,4	175	OM 902.916 <(906) Euro 4>	02.06→	<b>0 414 799 008</b>	<b>0 986 445 003</b> <b>0 986 445 103</b>
	7,2	175	OM 925.920 <(926 LA) EEV>	10.10→	<b>0 414 799 017</b>	
<b>916</b> BlueTec	4,3	115	OM 900... <Euro 4/5> Mot.Typ 900.912	02.06→	<b>0 414 799 008</b>	<b>0 986 445 003</b> <b>0 986 445 103</b>
			Mot.Typ 924.935	02.06→	<b>0 414 799 017</b>	
<b>918</b> BlueTec	4,3	130	OM 900.913 <(904) Euro 4>	02.06→	<b>0 414 799 008</b>	<b>0 986 445 003</b> <b>0 986 445 103</b>
<b>922</b>	4,8	160	OM 924.920 <Euro 3>	09.04→	<b>0 414 799 008</b>	<b>0 986 445 003</b> <b>0 986 445 103</b>
BlueTec	4,8	160	OM 924.922 LA <Euro 4> OM 924.930 LA <Euro 5/EEV>	06.06→ 06.06→	<b>0 414 799 012</b> <b>0 414 799 017</b>	
<b>923</b>	6,4	170	OM 906.915 <Euro 3>	09.04→	<b>0 414 799 008</b>	<b>0 986 445 003</b> <b>0 986 445 103</b>
<b>924</b> BlueTec	6,4	175	OM 902.916 <(906) Euro 4>	02.06→	<b>0 414 799 008</b>	<b>0 986 445 003</b> <b>0 986 445 103</b>
<b>926</b> BlueTec	6,4	188	OM 902.917 <(906 LA) Euro 4>	02.06→	<b>0 414 799 008</b>	<b>0 986 445 003</b> <b>0 986 445 103</b>
<b>1016</b> BlueTec	4,3	115	OM 900... <Euro 4/5> Mot.Typ 900.912	02.06→	<b>0 414 799 008</b>	<b>0 986 445 003</b> <b>0 986 445 103</b>
			Mot.Typ 924.935	02.06→	<b>0 414 799 017</b>	
<b>1018</b> BlueTec	4,3	130	OM 900.913 <(904) Euro 4>	02.06→	<b>0 414 799 008</b>	<b>0 986 445 003</b> <b>0 986 445 103</b>
<b>1022</b>	4,8	160	OM 924.920 <Euro 3>	09.04→	<b>0 414 799 008</b>	<b>0 986 445 003</b> <b>0 986 445 103</b>
BlueTec	4,8	160	OM 924.922 LA <Euro 4> OM 924.930 LA <Euro 5/EEV>	06.06→ 06.06→	<b>0 414 799 012</b> <b>0 414 799 017</b>	
<b>1023</b>	6,4	170	OM 906.915 <Euro 3>	09.04→	<b>0 414 799 008</b>	<b>0 986 445 003</b> <b>0 986 445 103</b>
<b>1024</b> BlueTec	6,4	175	OM 902.916 <(906) Euro 4>	02.06→	<b>0 414 799 008</b>	<b>0 986 445 003</b> <b>0 986 445 103</b>
<b>1216</b> BlueTec	4,3	115	OM 900... <Euro 4/5> Mot.Typ 900.912	02.06→	<b>0 414 799 008</b>	<b>0 986 445 003</b> <b>0 986 445 103</b>
			Mot.Typ 924.935	02.06→	<b>0 414 799 017</b>	
<b>1218</b> BlueTec	4,3	130	OM 900.913 <(904) Euro 4>	02.06→	<b>0 414 799 008</b>	<b>0 986 445 003</b> <b>0 986 445 103</b>
<b>1222</b>	4,8	160	OM 924.920 <Euro 3>	09.04→	<b>0 414 799 008</b>	<b>0 986 445 003</b> <b>0 986 445 103</b>
BlueTec	4,8	160	OM 924.922 LA <Euro 4> OM 924.930 LA <Euro 5/EEV>	06.06→ 06.06→	<b>0 414 799 012</b> <b>0 414 799 017</b>	
<b>1223</b>	6,4	170	OM 906.915 <Euro 3>	09.04→	<b>0 414 799 008</b>	<b>0 986 445 003</b> <b>0 986 445 103</b>
<b>1224</b> BlueTec	6,4	175	OM 902.916 <(906) Euro 4>	02.06→	<b>0 414 799 008</b>	<b>0 986 445 003</b> <b>0 986 445 103</b>
	7,2	175	OM 925.920 <(926 LA) EEV>	03.10→	<b>0 414 799 017</b>	
<b>1226</b> BlueTec	6,4	188	OM 902.917 <(906) Euro 4>	02.06→	<b>0 414 799 008</b>	<b>0 986 445 003</b> <b>0 986 445 103</b>
	7,2	188	OM 925.920 <(926 LA) EEV>	03.10→	<b>0 414 799 017</b>	
<b>1228</b>	6,4	205	OM 906.916 <(906) Euro 3>	09.04→	<b>0 414 799 008</b>	<b>0 986 445 003</b> <b>0 986 445 103</b>
<b>1229</b>	6,4	210	OM 902.918 <(906) Euro 4>	02.06→	<b>0 414 799 008</b>	<b>0 986 445 003</b> <b>0 986 445 103</b>
BlueTec	7,2	210	OM 925.920 <(926 LA) EEV>	03.10→	<b>0 414 799 017</b>	
<b>1318</b> BlueTec	4,3	130	OM 900.913 <(904) Euro 4>	02.06→	<b>0 414 799 008</b>	<b>0 986 445 003</b> <b>0 986 445 103</b>
<b>1322</b>	4,8	160	OM 924.920 <Euro 3>	09.04→	<b>0 414 799 008</b>	<b>0 986 445 003</b> <b>0 986 445 103</b>





<b>1322</b> BlueTec	4,8	160	OM 924.922 LA <Euro 4> OM 924.930 LA <Euro 5/EEV>	06.06→ 06.06→	<b>0 414 799 012</b> <b>0 414 799 017</b>	
<b>1323</b>	6,4	170	OM 906.915 <Euro 3>	09.04→	<b>0 414 799 008</b> <b>0 986 445 003</b> <b>0 986 445 103</b>	
<b>1324</b> BlueTec	6,4	175	OM 902.916 <(906) Euro 4>	02.06→	<b>0 414 799 008</b> <b>0 986 445 003</b> <b>0 986 445 103</b>	
	7,2	175	OM 925.920 <(926 LA) EEV>	03.10→	<b>0 414 799 017</b>	
<b>1326</b> BlueTec	6,4	188	OM 902.917 <(906) Euro 4>	02.06→	<b>0 414 799 008</b> <b>0 986 445 003</b> <b>0 986 445 103</b>	
	7,2	188	OM 925.920 <(926 LA) EEV>	03.10→	<b>0 414 799 017</b>	
<b>1328</b>	6,4	205	OM 906.916 <(906) Euro 3>	09.04→	<b>0 414 799 008</b> <b>0 986 445 003</b> <b>0 986 445 103</b>	
<b>1329</b>	6,4	210	OM 902.918 <(906) Euro 4>	02.06→	<b>0 414 799 008</b> <b>0 986 445 003</b> <b>0 986 445 103</b>	
BlueTec	7,2	210	OM 925.920 <(926 LA) EEV>	03.10→	<b>0 414 799 017</b>	
<b>1518</b> BlueTec	4,3	130	OM 900.913 <(904) Euro 4>	02.06→	<b>0 414 799 008</b> <b>0 986 445 003</b> <b>0 986 445 103</b>	
<b>1522</b>	4,8	160	OM 924.920 <Euro 3>	09.04→	<b>0 414 799 008</b> <b>0 986 445 003</b> <b>0 986 445 103</b>	
BlueTec	4,8	160	OM 924.922 LA <Euro 4> OM 924.930 LA <Euro 5/EEV>	06.06→ 06.06→	<b>0 414 799 012</b> <b>0 414 799 017</b>	
<b>1523</b>	6,4	170	OM 906.915 <Euro 3>	09.04→	<b>0 414 799 008</b> <b>0 986 445 003</b> <b>0 986 445 103</b>	
<b>1524</b> BlueTec	6,4	175	OM 902.916 <(906) Euro 4>	02.06→	<b>0 414 799 008</b> <b>0 986 445 003</b> <b>0 986 445 103</b>	
	7,2	175	OM 925.920 <(926 LA) EEV>	03.10→	<b>0 414 799 017</b>	
<b>1526</b> BlueTec	6,4	188	OM 902.917 <(906) Euro 4>	02.06→	<b>0 414 799 008</b> <b>0 986 445 003</b> <b>0 986 445 103</b>	
	7,2	188	OM 925.920 <(926 LA) EEV>	03.10→	<b>0 414 799 017</b>	
<b>1528</b>	6,4	205	OM 906.916 <(906) Euro 3>	09.04→	<b>0 414 799 008</b> <b>0 986 445 003</b> <b>0 986 445 103</b>	
<b>1529</b>	6,4	210	OM 902.918 <(906) Euro 4>	02.06→	<b>0 414 799 008</b> <b>0 986 445 003</b> <b>0 986 445 103</b>	
BlueTec	7,2	210	OM 925.920 <(926 LA) EEV>	03.10→	<b>0 414 799 017</b>	
<b>Axor</b>						
<b>1823</b>	6,4	170	OM 906... Komp.Nr. 505012/05/06	01.02-08.06 TNK	<b>0 414 799 008</b> <b>0 986 445 003</b> <b>0 986 445 103</b>	
			Komp.Nr. 505012/14	01.02-08.06 TNK	<b>0 414 799 014</b>	
<b>1828</b>	6,4	205	OM 906... Komp.Nr. 505012/05/06	01.02-08.06 TNK	<b>0 414 799 008</b> <b>0 986 445 003</b> <b>0 986 445 103</b>	
			Komp.Nr. 505012/14	01.02-08.06 TNK	<b>0 414 799 014</b>	
<b>1835</b> LS	11,7	260	OM 457.937 LA Komp.Nr. 505108 /03/04 Komp.Nr. 505108 /05/06 Komp.Nr. 505108/01	01.02-08.06 TNK 01.02-08.06 TNK 01.02-08.06 TNK	<b>0 414 799 007</b> <b>0 414 799 015</b> <b>0 414 799 005</b> <b>0 986 445 002</b> <b>0 986 445 102</b>	
<b>1840</b> LS	12,0	295	OM 457.937 LA Komp.Nr. 505108 /03/04 Komp.Nr. 505108 /05/06 Komp.Nr. 505108/01	01.02-08.06 TNK 01.02-08.06 TNK 01.02-08.06 TNK	<b>0 414 799 007</b> <b>0 414 799 015</b> <b>0 414 799 005</b> <b>0 986 445 002</b> <b>0 986 445 102</b>	
<b>1843</b> LS	11,7	315	OM 457.937 LA Komp.Nr. 505108 /03/04 Komp.Nr. 505108 /05/06 Komp.Nr. 505108/01	01.02-08.06 TNK 01.02-08.06 TNK 01.02-08.06 TNK	<b>0 414 799 007</b> <b>0 414 799 015</b> <b>0 414 799 005</b> <b>0 986 445 002</b> <b>0 986 445 102</b>	
<b>2523</b>	6,4	170	OM 906.920 LA Komp.Nr. 505012/05/06 Komp.Nr. 505012/14	01.02-08.06 TNK 01.02-08.06 TNK	<b>0 414 799 008</b> <b>0 986 445 003</b> <b>0 986 445 103</b> <b>0 414 799 014</b>	





◀ MERCEDES-BENZ

2528	6,4	205	OM 906.921 LA	01.02-08.06	TNK	0 414 799 008	0 986 445 003			
			Komp.Nr. 505012/05/06				0 986 445 103			
			Komp.Nr. 505012/14	01.02-08.06	TNK	0 414 799 014				
2535 LS	11,7	260	OM 457.937 LA	01.02-08.06	TNK	0 414 799 007				
			Komp.Nr. 505108/03/04							
			Komp.Nr. 505108/05/06				0 414 799 015			
			Komp.Nr. 505108/01				0 414 799 005	0 986 445 002		
							0 986 445 102			
2540 LS	11,7	295	OM 457.937 LA	01.02-08.06	TNK	0 414 799 007				
			Komp.Nr. 505108/03/04							
			Komp.Nr. 505108/05/06				0 414 799 015			
			Komp.Nr. 505108/01				0 414 799 005	0 986 445 002		
							0 986 445 102			
2543 LS	11,7	315	OM 457.937 LA	01.02-08.06	TNK	0 414 799 007				
			Komp.Nr. 505108/03/04							
			Komp.Nr. 505108/05/06				0 414 799 015			
			Komp.Nr. 505108/01				0 414 799 005	0 986 445 002		
							0 986 445 102			
2628	6,4	205	OM 906.921 LA	01.02-08.06	TNK	0 414 799 008	0 986 445 003			
			Komp.Nr. 505012/05/06				0 986 445 103			
			Komp.Nr. 505012/14	01.02-08.06	TNK	0 414 799 014				
3028	6,4	205	OM 906.921 <OM 906 LA>	03.03→	TNK	0 414 799 008	0 986 445 003			
			Komp.Nr. 505012/06				0 986 445 103			
			Komp.Nr. 505012/14				03.03→	TNK	0 414 799 014	
<b>Axor II</b>										
1824	6,4	175	OM 902... <(906 LA) Euro 4>	09.06→		0 414 799 008	0 986 445 003			
							0 986 445 103			
1826	6,4	188	OM 902... <(906 LA) Euro 4>	09.06→		0 414 799 008	0 986 445 003			
							0 986 445 103			
1829	6,4	210	OM 902.915 (OM 906) <Euro 4 (BlueTec)>	09.06→		0 414 799 008	0 986 445 003			
							0 986 445 103			
1833	7,2	240	OM 926...	09.04-08.06	TNK	0 414 799 008	0 986 445 003			
			Komp.Nr. 505012/05/06				0 986 445 103			
			Komp.Nr. 505012/14				09.04-08.06	TNK	0 414 799 014	
			OM 926.919 LA <Euro 4 (BlueTec)>				09.06→		0 414 799 012	
			OM 926.945 LA <Euro 5/EEV (BlueTec)>							
			Komp.Nr. 505012/ 13				12.09→	TNK	0 414 799 017	
			Komp.Nr. 505012/ 22				12.09→	TNK	0 414 799 013	
			Komp.Nr. 505012/06				12.09→	TNK	0 414 799 008	0 986 445 003
										0 986 445 103
			Komp.Nr. 505012/14				12.09→	TNK	0 414 799 014	
Komp.Nr. 505012/16	12.09→	TNK	0 414 799 012							
Komp.Nr. 505012/21	12.09→	TNK	0 414 799 019							
1836	12,0	265	OM 457.948 LA <Euro 4/5 (BlueTec)>	09.06→	TNK	0 414 799 005	0 986 445 002			
			Komp.Nr. 505108/01				0 986 445 102			
			Komp.Nr. 505108/05	09.06→	TNK	0 414 799 015				
1840	12,0	295	OM 457.948 LA <Euro 4/5 (BlueTec)>	09.06→	TNK	0 414 799 005	0 986 445 002			
			Komp.Nr. 505108/01				0 986 445 102			
			Komp.Nr. 505108/05	09.06→	TNK	0 414 799 015				
1843	12,0	315	OM 457.948 LA <Euro 4/5 (BlueTec)>	09.06→	TNK	0 414 799 005	0 986 445 002			
			Komp.Nr. 505108/01				0 986 445 102			
			Komp.Nr. 505108/05				09.06→	TNK	0 414 799 015	
2529	6,4	210	OM 902.915 (OM 906) <Euro 4 (BlueTec)>	09.06→		0 414 799 008	0 986 445 003			
							0 986 445 103			





2533	7,2	240	OM 926.913 LA	09.04-08.06	TNK	0 414 799 008	0 986 445 003					
			Komp.Nr. 505012/05/06					0 986 445 103				
			Komp.Nr. 505012/14						09.04-08.06	TNK	0 414 799 014	
			OM 926.919 LA <Euro 4 (BlueTec)>						09.06→		0 414 799 012	
			OM 926.945 LA <Euro 5/EEV (BlueTec)>									
			Komp.Nr. 505012/ 13						12.09→	TNK	0 414 799 017	
			Komp.Nr. 505012/ 22						12.09→	TNK	0 414 799 013	
			Komp.Nr. 505012/06						12.09→	TNK	0 414 799 008	0 986 445 003
											0 986 445 103	
											Komp.Nr. 505012/14	12.09→
			Komp.Nr. 505012/16	12.09→	TNK	0 414 799 012						
			Komp.Nr. 505012/21	12.09→	TNK	0 414 799 019						
2536	12,0	265	OM 457.948 LA <Euro 4/5 (BlueTec)>	09.06→	TNK	0 414 799 005	0 986 445 002					
			Komp.Nr. 505108/01					0 986 445 102				
			Komp.Nr. 505108/05	09.06→	TNK	0 414 799 015						
2540	12,0	295	OM 457.948 LA <Euro 4/5 (BlueTec)>	09.06→	TNK	0 414 799 005	0 986 445 002					
			Komp.Nr. 505108/01					0 986 445 102				
			Komp.Nr. 505108/05	09.06→	TNK	0 414 799 015						
2543	12,0	315	OM 457.948 LA <Euro 4/5 (BlueTec)>	09.06→	TNK	0 414 799 005	0 986 445 002					
			Komp.Nr. 505108/01					0 986 445 102				
			Komp.Nr. 505108/05	09.06→	TNK	0 414 799 015						
2629	6,4	210	OM 902.915 (OM 906) <Euro 4 (BlueTec)>	09.06→		0 414 799 008	0 986 445 003					
							0 986 445 103					
2633	7,2	240	OM 926.913 LA	09.04-08.06	TNK	0 414 799 008	0 986 445 003					
			Komp.Nr. 505012/05/06					0 986 445 103				
			Komp.Nr. 505012/14						09.04-08.06	TNK	0 414 799 014	
			OM 926.919 LA <Euro 4 (BlueTec)>						09.06→		0 414 799 012	
			OM 926.945 LA <Euro 5/EEV (BlueTec)>									
			Komp.Nr. 505012/ 13						12.09→	TNK	0 414 799 017	
			Komp.Nr. 505012/ 22						12.09→	TNK	0 414 799 013	
			Komp.Nr. 505012/06						12.09→	TNK	0 414 799 008	0 986 445 003
											0 986 445 103	
											Komp.Nr. 505012/14	12.09→
			Komp.Nr. 505012/16	12.09→	TNK	0 414 799 012						
			Komp.Nr. 505012/21	12.09→	TNK	0 414 799 019						
2635	12,0	260	OM 457.956 <(457 LA) Euro 3>	09.04→	TNK	0 414 799 015						
			Komp.Nr. 505108/05					09.04→	TNK	0 414 799 005	0 986 445 002	
			Komp.Nr. 522020/01								0 986 445 102	
			Komp.Nr. 505108/01									
2636	12,0	265	OM 457... <Euro 4/5 (BlueTec)>	09.06→	TW	0 414 799 005	0 986 445 002					
			Mot. Typ 457.957					0 986 445 102				
			Mot. Typ 457.948									
			Mot. Typ 457.980	09.06→	TW	0 414 799 015						
						0 414 799 021						
						0 414 799 024						
2640	12,0	295	OM 457... <Euro 4/5 (BlueTec)>	09.06→	TW	0 414 799 005	0 986 445 002					
			Mot. Typ 457.957					0 986 445 102				
			Mot. Typ 457.948									
											0 414 799 015	
			Mot. Typ 457.980	09.06→	TW	0 414 799 021						
			Mot. Typ 457.981			0 414 799 024						
2643	12,0	315	OM 457... <Euro 4/5 (BlueTec)>	09.06→	TW	0 414 799 005	0 986 445 002					
			Mot. Typ 457.957					0 986 445 102				
			Mot. Typ 457.948									
											0 414 799 015	
			Mot. Typ 457.980	09.06→	TW	0 414 799 021						
			Mot. Typ 457.981			0 414 799 024						





◀ MERCEDES-BENZ

3236	12,0	265	OM 457... <Euro 4/5 (BlueTec)>	09.06→	TW	0 414 799 005	0 986 445 002	
			Mot.Typ 457.957 Mot.Typ 457.948					0 986 445 102
							0 414 799 015	
			Mot.Typ 457.980	09.06→	TW	0 414 799 021	0 414 799 024	
			Mot.Typ 457.981					
3240	12,0	295	OM 457... <Euro 4/5 (BlueTec)>	09.06→	TW	0 414 799 005	0 986 445 002	
							0 986 445 102	
							0 414 799 015	
			Mot.Typ 457.980	09.06→	TW	0 414 799 021	0 414 799 024	
			Mot.Typ 457.981					
3243	12,0	315	OM 457... <Euro 4/5 (BlueTec)>	09.06→	TW	0 414 799 005	0 986 445 002	
							0 986 445 102	
							0 414 799 015	
			Mot.Typ 457.980	09.06→	TW	0 414 799 021	0 414 799 024	
			Mot.Typ 457.981					
3335	12,0	260	OM 457.956 LA <Euro 3>	09.04→	TNK	0 414 799 015		
							0 414 799 005	0 986 445 002
							0 986 445 102	
			Komp.Nr. 505108/05	09.04→	TNK	0 414 799 005	0 986 445 002	
			Komp.Nr. 522020/01					0 986 445 102
			Komp.Nr. 505108/01	09.04→	TNK	0 414 799 015	0 986 445 002	
								0 986 445 102
3340	12,0	295	OM 457.956 LA <Euro 3>	09.04→	TNK	0 414 799 015		
							0 414 799 005	0 986 445 002
							0 986 445 102	
			Komp.Nr. 505108/05	09.04→	TNK	0 414 799 005	0 986 445 002	
			Komp.Nr. 522020/01					0 986 445 102
			Komp.Nr. 505108/01	09.04→	TNK	0 414 799 015	0 986 445 002	
								0 986 445 102
3343	12,0	315	OM 457.956 LA <Euro 3>	09.04→	TNK	0 414 799 015		
							0 414 799 005	0 986 445 002
							0 986 445 102	
			Komp.Nr. 505108/05	09.04→	TNK	0 414 799 005	0 986 445 002	
			Komp.Nr. 522020/01					0 986 445 102
			Komp.Nr. 505108/01	09.04→	TNK	0 414 799 015	0 986 445 002	
								0 986 445 102
4135	12,0	260	OM 457.956 <(457 LA) Euro 3>	09.04→	TNK	0 414 799 015		
							0 414 799 005	0 986 445 002
							0 986 445 102	
			Komp.Nr. 505108/05	09.04→	TNK	0 414 799 005	0 986 445 002	
			Komp.Nr. 522020/01					0 986 445 102
			Komp.Nr. 505108/01	09.04→	TNK	0 414 799 015	0 986 445 002	
								0 986 445 102
4140	12,0	295	OM 457.956 <(457 LA) Euro 3>	09.04→	TNK	0 414 799 015		
							0 414 799 005	0 986 445 002
							0 986 445 102	
			Komp.Nr. 505108/05	09.04→	TNK	0 414 799 005	0 986 445 002	
			Komp.Nr. 522020/01					0 986 445 102
			Komp.Nr. 505108/01	09.06→	TNK	0 414 799 005	0 986 445 002	
								0 986 445 102
			OM 457.957 <Euro 4/5 (BlueTec)>	09.06→	TNK	0 414 799 005	0 986 445 002	
			Komp.Nr. 505108/01					0 986 445 102
							0 414 799 015	
			Komp.Nr. 505108/05	09.06→	TNK	0 414 799 015	0 986 445 002	
								0 986 445 102
4143	12,0	315	OM 457.956 <(457 LA) Euro 3>	09.04→	TNK	0 414 799 015		
							0 414 799 005	0 986 445 002
							0 986 445 102	
			Komp.Nr. 505108/05	09.04→	TNK	0 414 799 005	0 986 445 002	
			Komp.Nr. 522020/01					0 986 445 102
			Komp.Nr. 505108/01	09.06→	TNK	0 414 799 005	0 986 445 002	
								0 986 445 102
			OM 457.957 <Euro 4/5 (BlueTec)>	09.06→	TNK	0 414 799 005	0 986 445 002	
			Komp.Nr. 505108/01					0 986 445 102
							0 414 799 015	
			Komp.Nr. 505108/05	09.06→	TNK	0 414 799 015	0 986 445 002	
								0 986 445 102







Citro							
0 530	7,2	210	OM 926... <Euro 4 (BlueTec)>				
			Komp.Nr. 505012/ 13	10.06→	TNK	0 414 799 017	
			Mot. Typ 926.949				
			Komp.Nr. 505012/ 22	10.06→	TNK	0 414 799 013	
			Mot. Typ 926.949				
			Komp.Nr. 505012/06	10.06→	TNK	0 414 799 008	0 986 445 003
			Mot. Typ 926.939				0 986 445 103
			Komp.Nr. 505012/14	10.06→	TNK	0 414 799 014	
			Mot. Typ 926.939				
			Komp.Nr. 505012/16	10.06→	TNK	0 414 799 012	
			Mot. Typ 926.939				
			Komp.Nr. 505012/21	10.06→	TNK	0 414 799 019	
			Mot. Typ 926.939				
, G	12,0	260	OM 457... <Euro 4/5 (BlueTec)>				
			Komp.Nr. 505108/01	10.06→	TNK	0 414 799 005	0 986 445 002
			Mot. Typ 457.951				0 986 445 102
			Komp.Nr. 505108/05	10.06→	TNK	0 414 799 015	
			Mot. Typ 457.951				
			Mot. Typ 457.967				
			Mot. Typ 457.975	10.06→		0 414 799 021	
, G, GL CapaCity, GUE, L, Low Entry MUE, Low Entry UE, UE	12,0	220-260	OM 457... <Euro 4/5 (BlueTec)>				
			Mot. Typ 457.950,959	10.06→	TW	0 414 799 005	0 986 445 002
							0 986 445 102
						0 414 799 015	
			Mot. Typ 457.973	10.06→		0 414 799 021	
, K, Low Entry MUE, UE	6,4	210	OM 902... <(906 HLA)>; OM 902.925 LA(906) <Euro 4 (BlueTec)>				
			Komp.Nr. 505012/06	10.06→	TNK	0 414 799 008	0 986 445 003
							0 986 445 103
			Komp.Nr. 505012/14	10.06→	TNK	0 414 799 014	
GNUE3, GN3, GN3 UESTRA, N3	12,0	185/220/260	OM 457.933 HLA <Euro 2>; OM 457.934 HLA <Euro 2>; OM 457.935 HLA <Euro 2>				
			Komp.Nr. 505108/05	01.98-09.04	TNK	0 414 799 015	
			Komp.Nr. 522020/01	01.98-09.04	TNK	0 414 799 005	0 986 445 002
			Komp.Nr. 505108/01				0 986 445 102
GNUE3, GN3, GN3 UESTRA, N3, N3 UESTRA, N3/NUE3	6,4	170/180/205	OM 906.961 <Euro 3>; OM 906.962 <Euro 3>; OM 906.963 HLA <Euro 3>; OM 909.900,911 LA <Euro 2>; OM 909.901 LA <Euro 2>				
			Komp.Nr. 505012/05	01.99-09.06	TNK	0 414 799 008	0 986 445 003
			Komp.Nr. 505012/06				0 986 445 103
			Komp.Nr. 505012/09				
			Komp.Nr. 505012/14	01.99-09.06	TNK	0 414 799 014	
GNUE3, GN3, N3/NUE3	0,0	205	OM 909.921 LA <Euro 2>				
			Komp.Nr. 505012/05	01.99-09.04	TNK	0 414 799 008	0 986 445 003
			Komp.Nr. 505012/06				0 986 445 103
			Komp.Nr. 505012/09				
			Komp.Nr. 505012/14	01.99-09.04	TNK	0 414 799 014	
GN3, NUE3, N3	6,4	205	OM 906.960 LA <Euro 3>				
			Komp.Nr. 505012/05/06	04.99-09.06	TNK	0 414 799 008	0 986 445 003
							0 986 445 103
			Komp.Nr. 505012/14	04.99-09.06	TNK	0 414 799 014	
	12,0	185-260	OM 457.942 HLA <Euro 3>				
			Komp.Nr. 505108/01/02	04.99-10.06	TNK	0 414 799 005	0 986 445 002
							0 986 445 102
			Komp.Nr. 505108/05/06	04.99-10.06	TNK	0 414 799 015	
GN3, NUE3, N3, N3 UESTRA	6,4	205	OM 906.930 HLA <Euro 2>	01.98-09.04		0 414 799 008	0 986 445 003
							0 986 445 103
Low Entry	12,0	220-260	OM 457.941 HLA <Euro 3>				
			Komp.Nr. 505108/05/06	09.05-09.06	TNK	0 414 799 015	
			Komp.Nr. 505108/01	09.05-09.06	TNK	0 414 799 005	0 986 445 002
			Komp.Nr. 522020/01				0 986 445 102
			Komp.Nr. 505108/02				





◀ MERCEDES-BENZ

<b>0 530 N3</b>	12,0	195	OM 457.943 LA <Euro 3>				
			Komp.Nr. 505108 /05/06	04.00-09.06	TNK	<b>0 414 799 015</b>	
			Komp.Nr. 505108/01	04.00-09.06	TNK	<b>0 414 799 005</b>	<b>0 986 445 002</b>
N3/NUE3	0,0	170	OM 906.931 HLA <Euro 2>	01.98-09.04		<b>0 414 799 008</b>	<b>0 986 445 003</b>
							<b>0 986 445 103</b>

**Citaro L**

<b>0 530 N3</b>	0,0	205	OM 906.960 LA <Euro 3>						
			Komp.Nr. 505012/05/06	01.01-09.06	TNK	<b>0 414 799 008</b>	<b>0 986 445 003</b>		
			Komp.Nr. 505012/14	01.01-09.06	TNK	<b>0 414 799 014</b>	<b>0 986 445 103</b>		
			OM 909.921 LA <Euro 2>						
			Komp.Nr. 505012/05	01.99-09.04	TNK	<b>0 414 799 008</b>	<b>0 986 445 003</b>		
			Komp.Nr. 505012/06				<b>0 986 445 103</b>		
			Komp.Nr. 505012/09						
			Komp.Nr. 505012/14	01.99-09.04	TNK	<b>0 414 799 014</b>			
			6,4	205	OM 906.930 HLA <Euro 2>	01.99-09.04		<b>0 414 799 008</b>	<b>0 986 445 003</b>
									<b>0 986 445 103</b>
			OM 909.901 LA <Euro 2>						
			Komp.Nr. 505012/05	01.99-09.04	TNK	<b>0 414 799 008</b>	<b>0 986 445 003</b>		
			Komp.Nr. 505012/06				<b>0 986 445 103</b>		
			Komp.Nr. 505012/09						
			Komp.Nr. 505012/14	01.99-09.04	TNK	<b>0 414 799 014</b>			
			12,0	185/220	OM 457.934 HLA <Euro 2>; OM 457.935 HLA <Euro 2>				
			Komp.Nr. 505108/05	01.99-09.04	TNK	<b>0 414 799 015</b>			
			Komp.Nr. 522020/01	01.99-09.04	TNK	<b>0 414 799 005</b>	<b>0 986 445 002</b>		
			Komp.Nr. 505108/01				<b>0 986 445 102</b>		

**Conecto**

	6,4	210	OM 902.925 (906 LA) <Euro 4>						
			Komp.Nr. 505012/06	09.07→	TNK	<b>0 414 799 008</b>	<b>0 986 445 003</b>		
			Komp.Nr. 505012/14	09.07→	TNK	<b>0 414 799 014</b>	<b>0 986 445 103</b>		
			7,2	210	OM 926.939 (926 LA) <Euro 4>				
			Komp.Nr. 505012/06	09.07→	TNK	<b>0 414 799 008</b>	<b>0 986 445 003</b>		
							<b>0 986 445 103</b>		
			Komp.Nr. 505012/14	09.07→	TNK	<b>0 414 799 014</b>			
			Komp.Nr. 505012/16	09.07→	TNK	<b>0 414 799 012</b>			
			Komp.Nr. 505012/21	09.07→	TNK	<b>0 414 799 019</b>			

<b>G</b>	12,0	260	OM 457... <Euro 4/5>				
			Komp.Nr. 505108 /01	09.07→	TNK	<b>0 414 799 005</b>	<b>0 986 445 002</b>
			Komp.Nr. 505108/05	09.07→	TNK	<b>0 414 799 015</b>	<b>0 986 445 102</b>

<b>0 345</b>	6,4	205	OM 906.960 (906 LA) <Euro 2>				
			Komp.Nr. 505012/05	05.01-08.07	TNK	<b>0 414 799 008</b>	<b>0 986 445 003</b>
			Komp.Nr. 505012/14	05.01-08.07	TNK	<b>0 414 799 014</b>	<b>0 986 445 103</b>
			12,0	185-260	OM 457.942 (457 HLA) <Euro 3>		
			Komp.Nr. 505108/01	10.01-08.07	TNK	<b>0 414 799 005</b>	<b>0 986 445 002</b>
			Komp.Nr. 505108/05	10.01-08.07	TNK	<b>0 414 799 015</b>	<b>0 986 445 102</b>

**Econic**

<b>1823 L</b>	6,4	170	OM 906...; OM 906.951 LA <Euro 3>	03.98-09.06		<b>0 414 799 008</b>	<b>0 986 445 003</b>
							<b>0 986 445 103</b>
<b>1824</b>	6,4	175	OM 902.933 (OM 906) <Euro 4 (BlueTec)>				
			Komp.Nr. 505012/06	09.06→	TNK	<b>0 414 799 008</b>	<b>0 986 445 003</b>
			Komp.Nr. 505012/14	09.06→	TNK	<b>0 414 799 014</b>	<b>0 986 445 103</b>
<b>1828 L</b>	6,4	205	OM 906.941 LA <Euro 2>; OM 906.950 LA <Euro 3>; OM 906.952 LA <Euro 3>	03.98-09.06		<b>0 414 799 008</b>	<b>0 986 445 003</b>
							<b>0 986 445 103</b>
<b>1829</b>	6,4	210	OM 902.927 (OM 906) <Euro 4 (BlueTec)>				
			Komp.Nr. 505012/06	09.06→	TNK	<b>0 414 799 008</b>	<b>0 986 445 003</b>
			Komp.Nr. 505012/14	09.06→	TNK	<b>0 414 799 014</b>	<b>0 986 445 103</b>





<b>1833</b>	7,2	240	OM 926.924 LA <Euro 3>	03.00-09.06		<b>0 414 799 008</b>	<b>0 986 445 003</b>
							<b>0 986 445 103</b>
			OM 926.934 LA <Euro 4 (BlueTec)>				
			Komp.Nr. 505012/06	09.06→	TNK	<b>0 414 799 008</b>	<b>0 986 445 003</b>
							<b>0 986 445 103</b>
			Komp.Nr. 505012/14	09.06→	TNK	<b>0 414 799 014</b>	
<b>2628 L</b>	6,4	205	OM 906.941 LA <Euro 2>; OM 906.952 LA <Euro 3>	03.98-09.06		<b>0 414 799 008</b>	<b>0 986 445 003</b>
							<b>0 986 445 103</b>
<b>2629</b>	6,4	210	OM 902.927 (OM 906) <Euro 4 (BlueTec)>				
			Komp.Nr. 505012/06	09.06→	TNK	<b>0 414 799 008</b>	<b>0 986 445 003</b>
							<b>0 986 445 103</b>
			Komp.Nr. 505012/14	09.06→	TNK	<b>0 414 799 014</b>	
<b>2633</b>	7,2	240	OM 926.924 LA <Euro 3>	03.00-09.06		<b>0 414 799 008</b>	<b>0 986 445 003</b>
							<b>0 986 445 103</b>
			OM 926.934 LA <Euro 4 (BlueTec)>				
			Komp.Nr. 505012/06	09.06→	TNK	<b>0 414 799 008</b>	<b>0 986 445 003</b>
							<b>0 986 445 103</b>
			Komp.Nr. 505012/14	09.06→	TNK	<b>0 414 799 014</b>	
<b>3233</b>	7,2	240	OM 926.934 LA <Euro 4 (BlueTec)>				
			Komp.Nr. 505012/06	09.06→	TNK	<b>0 414 799 008</b>	<b>0 986 445 003</b>
							<b>0 986 445 103</b>
			Komp.Nr. 505012/14	09.06→	TNK	<b>0 414 799 014</b>	
<b>Integro I</b>							
<b>O 550 L, Ü, ÜH</b>	12,0	185-260	OM 457 HLA Euro 3 <457>	11.01-09.06		<b>0 414 799 005</b>	<b>0 986 445 002</b>
							<b>0 986 445 102</b>
<b>Integro II</b>							
	7,2	210	OM 926.939 LA <Euro 4 (BlueTec)>				
			Komp.Nr. 505012/06	09.06→	TNK	<b>0 414 799 008</b>	<b>0 986 445 003</b>
							<b>0 986 445 103</b>
			Komp.Nr. 505012/14	09.06→	TNK	<b>0 414 799 014</b>	
			Komp.Nr. 505012/16	09.06→	TNK	<b>0 414 799 012</b>	
			Komp.Nr. 505012/21	09.06→	TNK	<b>0 414 799 019</b>	
	12,0	220-300	OM 457... <Euro 4/5 (BlueTec)>				
			Mot. Typ 457.952/964	09.06→	TW	<b>0 414 799 005</b>	<b>0 986 445 002</b>
							<b>0 986 445 102</b>
			Mot. Typ 457.952/964/965	09.06→	TW	<b>0 414 799 015</b>	
			Mot. Typ 457.974	09.06→		<b>0 414 799 021</b>	
<b>L</b>	7,2	210	OM 926.939 LA <Euro 4 (BlueTec)>				
			Komp.Nr. 505012/06	09.06→	TNK	<b>0 414 799 008</b>	<b>0 986 445 003</b>
							<b>0 986 445 103</b>
			Komp.Nr. 505012/14	09.06→	TNK	<b>0 414 799 014</b>	
			Komp.Nr. 505012/16	09.06→	TNK	<b>0 414 799 012</b>	
			Komp.Nr. 505012/21	09.06→	TNK	<b>0 414 799 019</b>	
	12,0	220-300	OM 457... <Euro 4/5 (BlueTec)>				
			Mot. Typ 457.952/964	09.06→	TW	<b>0 414 799 005</b>	<b>0 986 445 002</b>
							<b>0 986 445 102</b>
			Mot. Typ 457.952/964/965	09.06→	TW	<b>0 414 799 015</b>	
			Mot. Typ 457.974	09.06→		<b>0 414 799 021</b>	
<b>M</b>	7,2	210	OM 926.939 LA <Euro 4 (BlueTec)>				
			Komp.Nr. 505012/06	09.06→	TNK	<b>0 414 799 008</b>	<b>0 986 445 003</b>
							<b>0 986 445 103</b>
			Komp.Nr. 505012/14	09.06→	TNK	<b>0 414 799 014</b>	
			Komp.Nr. 505012/16	09.06→	TNK	<b>0 414 799 012</b>	
			Komp.Nr. 505012/21	09.06→	TNK	<b>0 414 799 019</b>	
	12,0	220-300	OM 457... <Euro 4/5 (BlueTec)>				
			Mot. Typ 457.952/964	09.06→	TW	<b>0 414 799 005</b>	<b>0 986 445 002</b>
							<b>0 986 445 102</b>
			Mot. Typ 457.952/964/965	09.06→	TW	<b>0 414 799 015</b>	
			Mot. Typ 457.974	09.06→		<b>0 414 799 021</b>	
<b>O 345</b>							
	6,4	205	OM 906.960 (906 LA) <Euro 3>				
			Komp.Nr. 505012/05/06	10.01→	TNK	<b>0 414 799 008</b>	<b>0 986 445 003</b>
							<b>0 986 445 103</b>





◀ MERCEDES-BENZ

<b>G</b>	12,0	185-260	OM 457.942 (457 HLA) <Euro 3> Komp.Nr. 522020/01 Komp.Nr. 505108/01	10.01→	TNK	<b>0 414 799 005</b>	<b>0 986 445 002</b> <b>0 986 445 102</b>
<b>Tourino</b>							
<b>O 510</b>	6,4	180-205	OM 906... <Euro 3> Komp.Nr. 505012/06	01.04→	TNK	<b>0 414 799 008</b>	<b>0 986 445 003</b> <b>0 986 445 103</b>
			Komp.Nr. 505012/14	01.04→	TNK	<b>0 414 799 014</b>	
	7,2	210	OM 926... <Euro 4/5 (BlueTec)> Komp.Nr. 505012/ 13 Mot.Typ 926.949	09.06→	TNK	<b>0 414 799 017</b>	
			Komp.Nr. 505012/ 22 Mot.Typ 926.949	09.06→	TNK	<b>0 414 799 013</b>	
			Komp.Nr. 505012/06 Mot.Typ 926.939	09.06→	TNK	<b>0 414 799 008</b>	<b>0 986 445 003</b> <b>0 986 445 103</b>
			Komp.Nr. 505012/14 Mot.Typ 926.939	09.06→	TNK	<b>0 414 799 014</b>	
			Komp.Nr. 505012/16 Mot.Typ 926.939	09.06→	TNK	<b>0 414 799 012</b>	
			Komp.Nr. 505012/21 Mot.Typ 926.939	09.06→	TNK	<b>0 414 799 019</b>	
<b>Tourismo</b>							
	12,0	260-300	OM 457... <Euro 4/5 (BlueTec)> Mot.Typ 457.952	10.06→	TW	<b>0 414 799 005</b>	<b>0 986 445 002</b> <b>0 986 445 102</b>
						<b>0 414 799 015</b>	
			Mot.Typ 457.965	10.06→		<b>0 414 799 015</b>	
			Mot.Typ 457.974	10.06→		<b>0 414 799 021</b>	
<b>M, L</b>	12,0	315	OM 457... <Euro 4/5 (BlueTec)> Komp.Nr. 505108/01	10.06→	TNK	<b>0 414 799 005</b>	<b>0 986 445 002</b> <b>0 986 445 102</b>
			Komp.Nr. 505108/05	10.06→	TNK	<b>0 414 799 015</b>	
<b>RH</b>	12,0	260-300	OM 457... <Euro 4/5 (BlueTec)> Mot.Typ 457.965	09.09→		<b>0 414 799 015</b>	
			Mot.Typ 457.974	09.09→		<b>0 414 799 021</b>	
<b>RH-M</b>	12,0	260-300	OM 457... <Euro 4/5 (BlueTec)> Mot.Typ 457.965	09.09→		<b>0 414 799 015</b>	
			Mot.Typ 457.974	09.09→		<b>0 414 799 021</b>	
<b>15 RHD/SHD</b>	12,0	260-310	OM 457.944 LA <Euro 3> Komp.Nr. 505108 /03/04	10.99-09.04	TNK	<b>0 414 799 007</b>	
			Komp.Nr. 505108/05	10.99-09.04	TNK	<b>0 414 799 015</b>	
			Komp.Nr. 522020/01	10.99-09.04	TNK	<b>0 414 799 005</b>	<b>0 986 445 002</b> <b>0 986 445 102</b>
			Komp.Nr. 505108/01				
		310	OM 457.944 HLA <Euro 3> Komp.Nr. 505108/05	10.04-09.06	TNK	<b>0 414 799 015</b>	
<b>Touro</b>							
<b>OC 500</b>	12,0	260-310	OM 457.944 LA <Euro 3> Komp.Nr. 505108/05	10.02→	TNK	<b>0 414 799 015</b>	
			Komp.Nr. 522020/01	10.02→	TNK	<b>0 414 799 005</b>	<b>0 986 445 002</b> <b>0 986 445 102</b>
			Komp.Nr. 505108/01				
<b>Travego</b>							
<b>O 580</b>	12,0	315	OM 457.953 <(OM 457 LA) Euro 4> Komp.Nr. 505108 /01	02.06→	TNK	<b>0 414 799 005</b>	<b>0 986 445 002</b> <b>0 986 445 102</b>
			Komp.Nr. 505108/05	02.06→	TNK	<b>0 414 799 015</b>	
	15,9	350	OM 542.948 <(OM 502 LA)> Komp.Nr. 505108 /01/02	02.06→	TNK	<b>0 414 799 005</b>	<b>0 986 445 002</b> <b>0 986 445 102</b>
			Komp.Nr. 505108 /06	02.06→	TNK	<b>0 414 799 015</b>	
			OM 542.966 <(OM 502 LA) Euro 4> Komp.Nr. 505108 /06	02.06→	TNK	<b>0 414 799 015</b>	
			Komp.Nr. 505108/02	02.06→	TNK	<b>0 414 799 005</b>	<b>0 986 445 002</b> <b>0 986 445 102</b>





<b>0 580</b> RH(D)-15, RHD-17	12,0	260-310	OM 457... <Euro 3>; OM 457.938 LA <Euro 3> Komp.Nr. 505108/05 Komp.Nr. 522020/01 Komp.Nr. 505108/01	10.99-02.06 TNK 10.99-02.06 TNK	<b>0 414 799 015</b> <b>0 414 799 005</b> <b>0 986 445 002</b> <b>0 986 445 102</b>
RHD-17	15,9	320-350	OM 942.900 LA <(OM 502 LA) Euro 3>	02.01-02.06	<b>0 414 799 005</b> <b>0 986 445 002</b> <b>0 986 445 102</b>
<b>15</b> RHD	12,0	315	OM 457.961 <OM 457 LA (Euro 5)> Komp.Nr. 505108 /01 Komp.Nr. 505108/05	09.09→ TNK 09.09→ TNK	<b>0 414 799 005</b> <b>0 986 445 002</b> <b>0 986 445 102</b> <b>0 414 799 015</b>
<b>16</b> RHD-M	12,0	315	OM 457.961 <OM 457 LA (Euro 5)> Komp.Nr. 505108 /01 Komp.Nr. 505108/05	09.09→ TNK 09.09→ TNK	<b>0 414 799 005</b> <b>0 986 445 002</b> <b>0 986 445 102</b> <b>0 414 799 015</b>
<b>17</b> RHD-L	12,0	315	OM 457.961 <OM 457 LA (Euro 5)> Komp.Nr. 505108 /01 Komp.Nr. 505108/05	09.09→ TNK 09.09→ TNK	<b>0 414 799 005</b> <b>0 986 445 002</b> <b>0 986 445 102</b> <b>0 414 799 015</b>
<b>Unimog</b>					
<b>U</b> 20, 300, 400, 3000, 4000, 5000	4,3	100/110/ 115/125/ 130/160	OM 900.915 LA <Euro 4 (BlueTec)>; OM 900.921 LA <Euro 4 (BlueTec)>; OM 904.927 LA <Euro3>; OM 904.928 LA <Euro3>; OM 904.952 LA <Euro3>; OM 904.953 LA <Euro3>; OM 924.916 <Euro 3>	04.00→	<b>0 414 799 008</b> <b>0 986 445 003</b> <b>0 986 445 103</b>
400, 400/500, 500, 5000	6,4	170/175/ 205/210	OM 902.923 LA (906) <Euro 4 (BlueTec)>; OM 902.924 LA (906) <Euro 4 (BlueTec)>; OM 906.935 LA <Euro 3>; OM 906.935 LA <Euro3>; OM 906.955 LA <Euro3>	04.00→	<b>0 414 799 008</b> <b>0 986 445 003</b> <b>0 986 445 103</b>
4000, 5000	4,8	160	OM 924.931 <OM 924 LA (Euro 5)>; OM 924.931 <OM 924 LA Euro 5>	04.09→	<b>0 414 799 017</b>
4000/5000	4,8	160	OM 924.923 <Euro 4 (BlueTec)>	09.06→	<b>0 414 799 012</b>
<b>Vario</b>					
<b>0</b> 810, 814, 815 [T2W]	4,2	75/100/ 112	OM 904.904 LA <Euro 2>; OM 904.908 LA <Euro 2>; OM 904.923 LA <Euro 2>	09.96-01.01	<b>0 414 799 008</b> <b>0 986 445 003</b> <b>0 986 445 103</b>
<b>613</b> D [T2W]	4,2	95	OM 900.917 (904 LA) <Euro 4 (BlueTec)>	09.06→	<b>0 414 799 008</b> <b>0 986 445 003</b> <b>0 986 445 103</b>
<b>614</b> D [T2W]	4,2	100	OM 904.908 LA <Euro 2>; OM 904.914 LA <Euro 3>	09.96-09.06	<b>0 414 799 008</b> <b>0 986 445 003</b> <b>0 986 445 103</b>
<b>615</b> D [T2W]	4,2	110/112	OM 904.923 LA <Euro 2>; OM 904.936 LA <Euro 3>	10.98-09.06	<b>0 414 799 008</b> <b>0 986 445 003</b> <b>0 986 445 103</b>
<b>616</b> D [T2W]	4,2	115	OM 900.918 (904 LA) <Euro 4 (BlueTec)>	09.06→	<b>0 414 799 008</b> <b>0 986 445 003</b> <b>0 986 445 103</b>
<b>618</b> D [T2W]	4,2	130	OM 900.919 (904 LA) <Euro 4 (BlueTec)>; OM 904.964 LA <Euro 3>; OM 904.964 (904 LA)	06.03→	<b>0 414 799 008</b> <b>0 986 445 003</b> <b>0 986 445 103</b>
<b>810</b> DT [T2W]	4,2	75	OM 904.904 LA <Euro 2>	09.96-09.06	<b>0 414 799 008</b> <b>0 986 445 003</b> <b>0 986 445 103</b>
<b>813</b> D/DA [T2W]	4,2	95	OM 900.917 (904 LA) <Euro 4 (BlueTec)>	09.06→	<b>0 414 799 008</b> <b>0 986 445 003</b> <b>0 986 445 103</b>
<b>814</b> D [T2W]	4,2	100	OM 904.908 LA <Euro 2>; OM 904.914 LA <Euro 3>	09.96-09.06	<b>0 414 799 008</b> <b>0 986 445 003</b> <b>0 986 445 103</b>
DA [T2W]	4,3	100	OM 904... <Euro 2>	09.96-01.01	<b>0 414 799 008</b> <b>0 986 445 003</b> <b>0 986 445 103</b>
<b>815</b> D, DA [T2W]	4,2	110-112	OM 904... <Euro 2>; OM 904.923,936 LA <Euro 2>; OM 904.936 LA <Euro 3>	01.96-09.06	<b>0 414 799 008</b> <b>0 986 445 003</b> <b>0 986 445 103</b>
<b>816</b> D/DA [T2W]	4,2	115	OM 900.918 (904 LA) <Euro 4 (BlueTec)>	09.06→	<b>0 414 799 008</b> <b>0 986 445 003</b> <b>0 986 445 103</b>
<b>818</b> D, D/DA [T2W]	4,2	130	OM 900.919 (904 LA) <Euro 4 (BlueTec)>; OM 904.964 LA <Euro 3>; OM 904.964 (904 LA)	06.03→	<b>0 414 799 008</b> <b>0 986 445 003</b> <b>0 986 445 103</b>
<b>Zetros</b>					
<b>1833</b>	7,2	240	OM 926.935 <(926 LA) Euro 3> OM 926.947 <(926 LA) Euro 5>	09.08→ 09.09→	<b>0 414 799 008</b> <b>0 986 445 003</b> <b>0 986 445 103</b> <b>0 414 799 017</b>





◀ MERCEDES-BENZ

<b>2733</b>	7,2	240	OM 926.935 <(926 LA) Euro 3>	09.08→	<b>0 414 799 008</b>	<b>0 986 445 003</b>
			OM 926.947 <(926 LA) Euro 5>	09.09→	<b>0 414 799 017</b>	<b>0 986 445 103</b>
<b>7t</b>						
<b>711 [LK]</b>	4,3	90	OM 904.905 LA <Euro 2> Komp.Nr. 505012/05/06	03.96-12.99 TNK	<b>0 414 799 008</b>	<b>0 986 445 003</b>
						<b>0 986 445 103</b>
<b>8t</b>						
<b>811 [LK]</b>	4,3	90	OM 904.905 LA <Euro 2> Komp.Nr. 505012/05/06	03.96-12.99 TNK	<b>0 414 799 008</b>	<b>0 986 445 003</b>
						<b>0 986 445 103</b>
<b>814 , F, L, LO [LK]</b>	4,3	100	OM 904.906 LA <Euro 2>	03.96-12.99	<b>0 414 799 008</b>	<b>0 986 445 003</b>
						<b>0 986 445 103</b>
<b>817 , F, L, LO [LK]</b>	4,3	125	OM 904.907 LA <Euro 2>	03.96-12.99	<b>0 414 799 008</b>	<b>0 986 445 003</b>
						<b>0 986 445 103</b>
<b>9t</b>						
<b>917 , KO [LK]</b>	4,3	125	OM 904.907 LA <Euro 2>	03.96-12.99	<b>0 414 799 008</b>	<b>0 986 445 003</b>
						<b>0 986 445 103</b>
<b>11t</b>						
<b>1117 , L, LO [LK]</b>	4,3	125	OM 904.907 LA <Euro 2>	03.96-12.99	<b>0 414 799 008</b>	<b>0 986 445 003</b>
						<b>0 986 445 103</b>
<b>13t</b>						
<b>1317 , KO, L [LK]</b>	4,3	125	OM 904.907 LA <Euro 2>	03.96-12.99	<b>0 414 799 008</b>	<b>0 986 445 003</b>
						<b>0 986 445 103</b>
<b>15t</b>						
<b>1517 , L [LK]</b>	4,3	125	OM 904.907 LA <Euro 2>	03.96-12.99	<b>0 414 799 008</b>	<b>0 986 445 003</b>
						<b>0 986 445 103</b>

**RENAULT**

<b>Magnum</b>						
<b>400 E.TECH</b>	12,0	294	MACK E-TECH A <Euro 3>	03.01-09.04	<b>0 414 755 006</b>	<b>0 986 445 008</b>
		295	MIDR 06.24.65 A46 <Euro 2>	11.99-03.01	<b>0 414 755 002</b>	<b>0 986 445 001</b>
<b>440 E. TECH</b>	12,0	324	MACK E-TECH B <Euro 3>	03.01-09.04	<b>0 414 755 006</b>	<b>0 986 445 008</b>
			MIDR 06.24.65 B46 <Euro 2>	11.99-03.01	<b>0 414 755 002</b>	<b>0 986 445 001</b>
<b>480 E. TECH</b>	12,0	347	MIDR 06.24.65 C46 <Euro 2>	11.99-03.01	<b>0 414 755 002</b>	<b>0 986 445 001</b>
		353	MACK E-TECH C <Euro 3>	03.01-01.05	<b>0 414 755 006</b>	<b>0 986 445 008</b>

**SETRA**

<b>ComfortClass 400</b>						
<b>S415 GT, GT-HD</b>	12,0	185-310	OM 457.941 hLA <Euro 3>; OM 457.944 hLA <Euro 3>	02.03→	<b>0 414 799 005</b>	<b>0 986 445 002</b>
						<b>0 986 445 102</b>
<b>S416 GT-HD</b>	12,0	310	OM 457.944 hLA <Euro 3>	02.03→	<b>0 414 799 005</b>	<b>0 986 445 002</b>
						<b>0 986 445 102</b>
<b>S417 GT-HD</b>	12,0	260-310	OM 457.944 hLA <Euro 3>	02.03→	<b>0 414 799 005</b>	<b>0 986 445 002</b>
						<b>0 986 445 102</b>
<b>MultiClass 300</b>						
<b>S313 UL</b>	12,0	185	OM 457 HLA <Euro 3>	07.01-09.05	<b>0 414 799 005</b>	<b>0 986 445 002</b>
						<b>0 986 445 102</b>
<b>S315 H, NF, UL</b>	12,0	185/220	OM 457 HLA <Euro 3>	07.01-09.05	<b>0 414 799 005</b>	<b>0 986 445 002</b>
						<b>0 986 445 102</b>
<b>S316 UL</b>	12,0	185	OM 457 HLA <Euro 3>	07.01-09.05	<b>0 414 799 005</b>	<b>0 986 445 002</b>
						<b>0 986 445 102</b>
<b>S317 UL</b>	12,0	185	OM 457 HLA <Euro 3>	07.01-09.05	<b>0 414 799 005</b>	<b>0 986 445 002</b>
						<b>0 986 445 102</b>
<b>S319 NF, UL</b>	12,0	185	OM 457 HLA <Euro 3>	07.01-09.05	<b>0 414 799 005</b>	<b>0 986 445 002</b>
						<b>0 986 445 102</b>
<b>SG 321 UL</b>	12,0	220	OM 457 HLA <Euro 3>	07.01-09.05	<b>0 414 799 005</b>	<b>0 986 445 002</b>
						<b>0 986 445 102</b>





l/ccm



kW/(PS)



Typ



AUDI

A2											
1.2 TDI 3L [8Z0]	1,2	45	ANY		03.01-08.05	0 414 720 084	0 986 441 555				
1.4 TDI [8Z0]	1,4	55	AMF		09.99-08.03	0 414 720 085	0 986 441 551				
			BHC		05.03-08.05		0 986 441 559				
			ATL		11.03-08.05	0 414 720 266	0 986 441 560				
A3											
1.9 TDI [8L1]	1,9	74	ATD		09.00-06.03	0 414 720 087	0 986 441 566				
			AXR		11.01-06.03	0 414 720 213	0 986 441 559				
			TDI [8P1]	77	BKC		06.03-05.06		0 986 441 559		
					BLS		11.05-05.10	0 414 720 363	0 986 441 568		
					BXE		06.06-05.10		0 986 441 559		
TDI, TDI quattro [8L1]	1,9	96	ASZ		05.00-06.03	0 414 720 089	0 986 441 557				
2.0 TDI [8P1]	2,0	103	BKD		Fg.Nr. →8P..4..160 000	05.03-03.04	0 414 720 453	0 986 441 580			
					Fg.Nr. 8P..4..160 001→	04.04-06.08	0 414 720 454	0 986 441 566			
			TDI quattro [8P1]	2,0	103	BKD		11.04-06.08	0 414 720 454	0 986 441 566	
			TDI, TDI quattro [8P1]	2,0	100	AZV		Fg.Nr. →8P..4..160 000	05.03-03.04	0 414 720 453	0 986 441 580
								Fg.Nr. 8P..4..160 001→	04.04-06.08	0 414 720 454	0 986 441 566
							103	BMM		01.05-06.08	0 414 720 362
A3 Cabriolet											
1.9 TDI [8P7]	1,9	77	BLS <D3W>		04.08-05.09	0 414 720 363	0 986 441 568				
A3 Sportback											
1.9 TDI [8PA]	1,9	77	BKC		09.04-05.06		0 986 441 559				
			BLS <D3W>		11.05-05.10	0 414 720 363	0 986 441 568				
			BXE <D3W>		06.06-05.10		0 986 441 559				
2.0 TDI, TDI quattro [8PA]	2,0	100/103	AZV; BKD		09.04-06.08	0 414 720 454	0 986 441 566				
		103	BMM		02.05-06.08	0 414 720 362	0 986 441 567				
A4											
1.9 TDI [8EC; B7]	1,9	85	BKE		11.04-11.05	0 414 720 280	0 986 441 575				
			BRB		01.06-06.08	0 414 720 364	0 986 441 577				
			TDI [8E2; B6]	74	AVB		04.01-05.04	0 414 720 087	0 986 441 556		
					85	BKE		Fg.Nr. →8E..5..070 250	06.04-07.04	0 414 720 276	0 986 441 571
							Fg.Nr. 8E..5..070 251→	08.04-12.04	0 414 720 280	0 986 441 575	
TDI, TDI quattro [8D2; B5]	1,9	85	AJM; ATJ		08.98-11.00	0 414 720 007	0 986 441 551				
TDI, TDI quattro [8E2; B6]	1,9	96	AVF; AWX		12.00-12.04	0 414 720 266	0 986 441 560				
2.0 TDI [8EC; B7]	2,0	89/93/	BRE; BRF; BVF; BVG		06.05-06.08	0 414 720 454	0 986 441 566				
		100/103									
		100/103	BLB; BNA		11.04-10.05	0 414 720 454	0 986 441 566				
TDI, TDI quattro [8EC; B7]	2,0	103	BPW		11.04-06.08	0 414 720 279	0 986 441 574				
A4 Avant											
1.9 TDI [8ED; B7]	1,9	85	BKE		11.04-12.05	0 414 720 280	0 986 441 575				
			BRB		01.06-06.08	0 414 720 364	0 986 441 577				
			TDI [8E5; B6]	74	AVB		09.01-05.04	0 414 720 087	0 986 441 556		
					85	BKE		Fg.Nr. →8E..5..070 250	06.04-07.04	0 414 720 276	0 986 441 571
							Fg.Nr. 8E..5..070 251→	08.04-12.04	0 414 720 280	0 986 441 575	
TDI, TDI quattro [8D5; B5]	1,9	85	AJM; ATJ		08.98-09.01	0 414 720 007	0 986 441 551				
TDI, TDI quattro [8E5; B6]	1,9	96	AVF; AWX		09.01-12.04	0 414 720 266	0 986 441 560				
2.0 TDI [8ED; B7]	2,0	89/93/	BRE; BRF; BVF; BVG		06.05-06.08	0 414 720 454	0 986 441 566				
		100/103									
		100/103	BLB; BNA		11.04-11.05	0 414 720 454	0 986 441 566				
TDI, TDI quattro [8ED; B7]	2,0	103	BPW		11.04-06.08	0 414 720 279	0 986 441 574				
A4 Cabriolet											
2.0 TDI [8HE; B7]	2,0	100/103	BPW; BRC		01.06-03.09	0 414 720 279	0 986 441 574				



A



◀ AUDI

A6							
1.9 TDI [4B2; C5]	1,9	85	AJM	05.99-04.01	0 414 720 085	0 986 441 551	
			AVF; AWX	06.01-05.04	0 414 720 266	0 986 441 560	
2.0 TDI [4F2; C6]	2,0	89/100/103	BLB; BNA; BRE; BRF; BVG	07.04-06.08	0 414 720 454	0 986 441 566	
A6 Avant							
1.9 TDI [4B5; C5]	1,9	85	AJM	02.98-04.01	0 414 720 085	0 986 441 551	
			AVF; AWX	06.01-01.05	0 414 720 266	0 986 441 560	
2.0 TDI [4F5; C6]	2,0	89/100/103	BLB; BNA; BRE; BRF; BVG	06.05-10.08	0 414 720 454	0 986 441 566	

**FORD**

Galaxy							
1.9 TDI [00]	1,9	66	ANU <19NPD>	04.00-04.01	0 414 720 014	0 986 441 553	
				05.01-08.06	0 414 720 086		
			85 AUJ <19PPD>	04.00-08.06	0 414 720 088		
			96 ASZ <19PPD>	01.03-08.06	0 414 720 266		
TDI [95]	1,9	66	ANU <D19TI (VW 19N PD)>	09.99-03.00	0 414 720 014	0 986 441 553	

**MITSUBISHI**

Grandis							
2.0 DI-D	2,0	100-103	BSY	06.05-→	0 414 720 454		
Lancer							
2.0 DI-D [CY/CZ]	2,0	103	BKD	02.08-08.10	0 414 720 454		
Lancer Sportback							
2.0 DI-D [CX]	2,0	103	BKD	08.08-08.10	0 414 720 454		
Outlander							
2.0 DI-D 4x4 [CW]	2,0	103	BSY	02.07-06.10	0 414 720 454		

**SEAT**

Alhambra								
1.9 TDI [7V9]	1,9	66	ANU	06.00-03.10	0 414 720 086	0 986 441 553		
			TDI, TDI 4Motion [7V9]	85 AUJ	06.00-03.10	0 414 720 088		
				BVK	11.05-03.10	0 414 720 364	0 986 441 577	
				96 ASZ	11.02-11.08	0 414 720 266	0 986 441 560	
2.0 TDI [7V9]	2,0	103	BRT	11.05-03.10	0 414 720 279	0 986 441 574		
Altea								
1.9 TDI [5P1]	1,9	66/77	BXE <D3W>; BXF <MF7>	02.06-12.10		0 986 441 559		
			77 BJB; BKC	04.04-05.06		0 986 441 559		
				10.05-05.10	0 414 720 363	0 986 441 568		
				04.04-03.09	0 414 720 454	0 986 441 566		
2.0 TDI [5P1]	2,0	100/103	BKD <D3X>					
				Fg.Nr. →5P..4..003 500	03.04-03.04	0 414 720 453	0 986 441 580	
				Fg.Nr. 5P..4..003 501→	04.04-07.11	0 414 720 454	0 986 441 566	
				BMM <D7N>	11.05-11.10	0 414 720 362	0 986 441 567	
Altea Freetrack								
2.0 TDI, TDI 4WD [5P5/5P8]	2,0	103	BMM <D7N>	06.07-10.10	0 414 720 362	0 986 441 567		
Altea XL								
1.9 TDI [5P5]	1,9	66/77	BXE <D3W>; BXF <MF7>	10.06-12.10		0 986 441 559		
			77 BLS <D3W>	10.06-09.10	0 414 720 363	0 986 441 568		
2.0 TDI [5P5]	2,0	100/103	AZV; BKD <D3X>	05.06-09.11	0 414 720 454	0 986 441 566		
			103 BMM <D7N>	10.06-11.10	0 414 720 362	0 986 441 567		
Arosa								
1.4 TDI [6H1]	1,4	55	AMF	01.98-06.04	0 414 720 085	0 986 441 551		







<b>Cordoba</b>									
1.4 TDI [6L2]	1,4	51/58	BNM; BNV		05.05-11.09		0 986 441 559		
		55	AMF		10.02-12.05	0 414 720 085	0 986 441 551		
		59	BMS		06.06-11.09	0 414 720 364	0 986 441 577		
1.9 TDI [6L2]	1,9	74	ATD		09.02-07.05	0 414 720 087	0 986 441 556		
			AXR		05.05→		0 986 441 559		
			BMT		09.06-11.09	0 414 720 363	0 986 441 568		
		96	ASZ		10.02-09.05	0 414 720 089	0 986 441 557		
			BLT		05.05→	0 414 720 266	0 986 441 560		
<b>Ibiza</b>									
1.4 TDI [6J5]	1,4	59	BMS <D4T>		08.08-06.10	0 414 720 364	0 986 441 577		
		TDI [6L1]	1,4	51/59	BNM; BNV		05.05-11.09	0 986 441 559	
				55	AMF		05.02-12.05	0 414 720 085	0 986 441 551
1.9 TDI [6J5]	1,9	66/77	BLS <D3W>; BXJ		02.08-06.10	0 414 720 363	0 986 441 568		
		TDI [6L1]	1,9	74	ATD		09.01-05.05	0 414 720 087	0 986 441 556
				AXR		05.05-11.09		0 986 441 559	
BMT				09.06-11.09	0 414 720 363	0 986 441 568			
TDI Cupra R [6L1]	1,9	118	ASZ		11.01-09.05	0 414 720 089	0 986 441 557		
			BLT		05.05-11.09	0 414 720 266	0 986 441 560		
			BPX		03.04-11.05	0 414 720 089	0 986 441 557		
			BUK		11.05-02.08	0 414 720 279	0 986 441 574		
<b>Ibiza Sportcoupé</b>									
1.4 TDI [6J1]	1,4	59	BMS <D4T>		07.08-06.10	0 414 720 364	0 986 441 577		
1.9 TDI [6J1]	1,9	66/77	BLS <D3W>; BXJ		02.08-06.10	0 414 720 363	0 986 441 568		
<b>Leon</b>									
1.9 TDI [1M1]	1,9	74	AXR		10.05-06.06		0 986 441 559		
		TDI [1P1]	1,9	66/77	BXE <D3W>; BXF <MF7>		02.06-12.10	0 986 441 559	
77	BKC				07.05-02.06		0 986 441 559		
	BLS <D3W>				11.05-05.10	0 414 720 363	0 986 441 568		
TDI, TDI Syncro [1M1]	1,9	96/110	ARL; ASZ		09.00-06.06	0 414 720 089	0 986 441 557		
2.0 TDI [1P1]	2,0	100/103	AZY; BKD <D3X>		07.05→	0 414 720 453	0 986 441 580		
		103	BMM <D7N>		10.05-10.10	0 414 720 362	0 986 441 567		
<b>Toledo</b>									
1.9 TDI [1M2]	1,9	96	ASZ		05.03-07.04	0 414 720 089	0 986 441 557		
		110	ARL		09.00-05.02	0 414 720 089	0 986 441 557		
		TDI [5P2]	1,9	77	BJB; BKC		09.04-02.06		0 986 441 559
	BLS				10.05-05.09	0 414 720 363	0 986 441 568		
	BXE				02.06→		0 986 441 559		
2.0 TDI [5P2]	2,0	100/103	AZV; BKD		09.04-05.09	0 414 720 453	0 986 441 580		
		103	BMM		01.06-05.09	0 414 720 362	0 986 441 567		
<b>SKODA</b>									
<b>Fabia</b>									
1.4 TDI [6Y3]	1,4	51/59	BNM; BNV		10.05-12.07		0 986 441 559		
		55	AMF		05.03-10.05	0 414 720 085	0 986 441 551		
1.9 TDI [6Y3]	1,9	74	ATD		09.99-10.05	0 414 720 087	0 986 441 556		
			AXR		10.05-12.07		0 986 441 559		
<b>Fabia Combi</b>									
1.4 TDI [5J5]	1,4	51/59	BNM <D4S>; BNV <D4T>		10.07-03.10		0 986 441 559		
		59	BMS <D4T>		10.07-03.10	0 414 720 364	0 986 441 577		
TDI [6Y5]	1,4	51/59	BNM; BNV		10.05-12.07		0 986 441 559		
		55	AMF		05.03-10.05	0 414 720 085	0 986 441 551		
1.9 TDI [5J5]	1,9	77	BLS <D3W>		10.07-03.10	0 414 720 363	0 986 441 568		
			BSW <D3W>		10.07-03.10		0 986 441 559		
TDI [6Y5]	1,9	74	ATD		08.00-10.05	0 414 720 087	0 986 441 556		
			AXR		10.05-12.07		0 986 441 559		





◀ SKODA

Fabia Schrägheck						
1.4 TDI [5J2, 572]	1,4	51/59	BNM <D4S>; BNV <D4T>	01.07-03.10		0 986 441 559
		59	BMS <D4T>	01.07-03.10	0 414 720 364	0 986 441 577
TDI [6Y2]	1,4	51/59	BNM; BNV	10.05-04.07		0 986 441 559
		55	AMF	05.03-04.07	0 414 720 085	0 986 441 551
1.9 TDI [5J2, 572]	1,9	77	BLS <D3W>	04.07-03.10	0 414 720 363	0 986 441 568
			BSW <D3W>	04.07-03.10		0 986 441 559
TDI [6Y2]	1,9	74	ATD	09.99-10.05	0 414 720 087	0 986 441 556
			AXR	10.05-04.07		0 986 441 559
TDI RS [6Y2]	1,9	96	ASZ	06.03-10.05	0 414 720 089	0 986 441 557
			BLT	10.05-04.07	0 414 720 266	0 986 441 560
Octavia						
1.9 TDI [1U2]	1,9	74	AXR	10.05-12.10		0 986 441 559
		96	ASZ	01.03-09.04	0 414 720 089	0 986 441 557
TDI, TDI 4x4 [1Z3]	1,9	77	BJB <D3W>; BKC <D3W>	05.04-12.10		0 986 441 559
			BLS <D3W>	05.06-05.10	0 414 720 363	0 986 441 568
			BXE <D3W>	02.06-→		0 986 441 559
2.0 TDI [1Z3]	2,0	100/103	AZV <MS9>; BKD <D3W>	05.04-05.10	0 414 720 454	0 986 441 566
		103	BMM <D7N>	11.05-05.10	0 414 720 362	0 986 441 567
Octavia Combi						
1.9 TDI [1U5]	1,9	74	AXR	10.05-12.10		0 986 441 559
		96	ASZ	01.03-09.04	0 414 720 089	0 986 441 557
TDI, TDI 4x4 [1U5]	1,9	74	ATD	08.00-01.06	0 414 720 087	0 986 441 556
TDI, TDI 4x4 [1Z5]	1,9	77	BJB <D3W>; BKC <D3W>	05.04-→		0 986 441 559
			BLS <D3W>	05.06-05.10	0 414 720 363	0 986 441 568
			BXE <D3W>	11.04-→		0 986 441 559
2.0 TDI [1Z5]	2,0	100/103	AZV <MS9>; BKD <D3W>	05.04-05.10	0 414 720 454	0 986 441 566
TDI, TDI 4x4 [1Z5]	2,0	103	BMM <D7N>	11.05-05.10	0 414 720 362	0 986 441 567
Praktik						
1.4 TDI [5J7]	1,4	51/59	BMS; BNM; BNV	03.07-→	0 414 720 364	0 986 441 577
Roomster						
1.4 TDI [5J7]	1,4	51/59	BMS <D4T>; BNM <D4S>; BNV <D4T>	05.06-03.10	0 414 720 364	0 986 441 577
1.9 TDI [5J7]	1,9	74	AXR	03.06-05.06		0 986 441 559
		77	BLS <D3W>	11.06-03.10	0 414 720 363	0 986 441 568
			BSW <D3W>	05.06-03.10		0 986 441 559
Superb						
1.9 TDI [3T4]	1,9	77	BLS <D3W>	03.08-→	0 414 720 363	0 986 441 568
			BXE	03.08-→		0 986 441 559
TDI [3U4]	1,9	74	AVB	02.02-10.05	0 414 720 087	0 986 441 556
		77/85	BPZ; BSV	10.05-03.08	0 414 720 280	0 986 441 575
		96	AVF	01.04-03.08	0 414 720 266	0 986 441 560
			AWX			
			Fg.Nr. →3U...3..039 898	12.01-03.03	0 414 720 214	0 986 441 560
			Fg.Nr. 3U...3..039 899→	04.03-03.08	0 414 720 266	0 986 441 560
2.0 TDI [3T4]	2,0	103	BKD	01.09-→	0 414 720 454	0 986 441 566
TDI [3U4]	2,0	91/103	BMP <D7N>	03.08-03.10	0 414 720 362	0 986 441 567
			BSS; BWW	10.05-03.08	0 414 720 279	0 986 441 574
Superb Combi						
1.9 TDI [3T5]	1,9	77	BLS	09.09-→	0 414 720 363	0 986 441 568
			BXE	09.09-→		0 986 441 559
2.0 TDI [3T5]	2,0	103	BKD	09.09-→	0 414 720 454	0 986 441 566
			BMP	09.09-→	0 414 720 362	0 986 441 567





**VW (VOLKSWAGEN)**

<b>Bora</b>						
1.9 TDI [1J2]	1,9	74	AXR		05.01-05.05	0 986 441 559
TDI, TDI 4 Motion [1J2]	1,9	74	ATD		01.00-05.05	0 414 720 087 0 986 441 556
			AJM		09.98-05.01	0 414 720 085 0 986 441 551
			AUY		01.00-04.01	0 414 720 085 0 986 441 551
			96/110 ARL; ASZ		01.00-05.05	0 414 720 089 0 986 441 557
<b>Bora Variant</b>						
1.9 TDI [1J6]	1,9	74	AXR		05.01-05.05	0 986 441 559
TDI, TDI 4 Motion [1J6]	1,9	74	ATD		05.00-05.05	0 414 720 087 0 986 441 556
			AJM		05.99-05.00	0 414 720 085 0 986 441 551
			AUY		01.00-04.01	0 414 720 085 0 986 441 551
			96/110 ARL; ASZ		01.01-05.05	0 414 720 089 0 986 441 557
<b>Caddy</b>						
1.9 TDI [2K]	1,9	77	BJB <D3W>		02.04-08.10	0 986 441 559
TDI, TDI 4 Motion [2K]	1,9	55/77	BLS <D3W>; BSU <D4U>		06.05-08.10	0 414 720 363 0 986 441 568
2.0 SDI [2K]	2,0	51	BDJ <DOK>		02.04-08.10	0 414 720 271 0 986 441 562
			BST <DOK>		06.05-08.10	0 414 720 282 0 986 441 564
			TDI [2K]	2,0	103	BMM <D7N>
<b>Eos</b>						
2.0 TDI [1F7]	2,0	103	BMM		05.06-05.08	0 414 720 362 0 986 441 567
<b>Fox</b>						
1.4 TDI [5Z1]	1,4	51	BNM <D4S>		04.05→	0 986 441 559
<b>Golf IV</b>						
1.9 TDI [1J1]	1,9	74	AXR		05.01-05.04	0 414 720 213 0 986 441 559
TDI, TDI 4 Motion [1J1]	1,9	74	ATD		02.00-06.05	0 414 720 087 0 986 441 556
			AJM		05.99-07.01	0 414 720 085 0 986 441 551
			AUY		01.00-07.01	0 414 720 085 0 986 441 551
			96/110 ARL; ASZ		09.00-06.05	0 414 720 089 0 986 441 557
<b>Golf IV Variant</b>						
1.9 TDI [1J5]	1,9	74	AXR		05.01-06.06	0 414 720 213 0 986 441 559
TDI, TDI 4 Motion [1J5]	1,9	74	ATD		01.00-06.06	0 414 720 087 0 986 441 556
			AJM		05.99-07.01	0 414 720 085 0 986 441 551
			AUY		11.99-07.01	0 414 720 085 0 986 441 551
			96 ASZ		04.01-06.06	0 414 720 089 0 986 441 557
<b>Golf Plus</b>						
1.9 TDI [5M1]	1,9	66	BXJ		11.07-01.09	0 414 720 363 0 986 441 568
			66/77 BRU; BXE; BXF		05.05-01.09	0 986 441 559
			77 BKC		01.05-05.06	0 986 441 559
			BLS		06.05-01.09	0 414 720 363 0 986 441 568
2.0 TDI [5M1]	2,0	100/103 AZV; BKD		01.05-05.09	0 414 720 454 0 986 441 566	
		103 BMM		12.05-01.09	0 414 720 362 0 986 441 567	
<b>Golf V</b>						
1.9 TDI [1K1]	1,9	66	BXJ		05.07-11.08	0 414 720 363 0 986 441 568
TDI, TDI 4 Motion [1K1]	1,9	66/77	BRU; BXE; BXF		05.04-11.08	0 986 441 559
			77 BKC		10.03-02.06	0 986 441 559
			BLS		08.05-11.08	0 414 720 363 0 986 441 568
			2.0 SDI [1K1]	2,0	55	BDK
TDI [1K1]	2,0	100	AZV			
			Fg.Nr. →1K..4B055 531→1K..4P049 474→		10.03-02.04	0 414 720 453 0 986 441 580
			1K..4U000 050→1K..4W098 000			
			Fg.Nr. 1K..4B055 532→1K..4B070 759		03.04-03.04	AG 0 414 720 454 0 986 441 566
			1K..4P049 475→1K..4P060 890		GS 0 414 720 453 0 986 441 580	
			1K..4U000 051→1K..4U000 169			
			1K..4W098 001→1K..4W124 231			
			Fg.Nr. 1K..4B070 760→1K..4P060 891→		04.04-11.08	0 414 720 454 0 986 441 566
			1K..4U000 170→1K..4W124 232→			





◀ VW

<b>2.0 TDI, TDI 4 Motion [1K1]</b>	2,0	103	BKD					
				Fg.Nr. →1K..4B055 531 →1K..4P049 474 → 1K..4U000 050 →1K..4W098 000	10.03-02.04		<b>0 414 720 453</b>	<b>0 986 441 580</b>
				Fg.Nr. 1K..4B055 532 →1K..4B070 759	03.04-03.04	AG	<b>0 414 720 454</b>	<b>0 986 441 566</b>
				1K..4P049 475 →1K..4P060 890		GS	<b>0 414 720 453</b>	<b>0 986 441 580</b>
				1K..4U000 051 →1K..4U000 169 1K..4W098 001 →1K..4W124 231				
				Fg.Nr. 1K..4B070 760 →1K..4P060 891 → 1K..4U000 170 →1K..4W124 232 →	04.04-11.08		<b>0 414 720 454</b>	<b>0 986 441 566</b>
			BMM		12.04-11.08		<b>0 414 720 362</b>	<b>0 986 441 567</b>
<b>Golf V Variant</b>								
<b>1.9 TDI [1K5]</b>	1,9	77	BXE		05.07-11.08			<b>0 986 441 559</b>
TDI, TDI 4 Motion [1K5]	1,9	77	BLS		05.07-06.09		<b>0 414 720 363</b>	<b>0 986 441 568</b>
<b>2.0 TDI [1K5]</b>	2,0	103	BMM		05.07-05.08		<b>0 414 720 362</b>	<b>0 986 441 567</b>
TDI, TDI 4 Motion [1K5]	2,0	100/103	AZV; BKD		05.07-06.09		<b>0 414 720 454</b>	<b>0 986 441 566</b>
<b>Golf VI Variant</b>								
<b>2.0 TDI [AJ5]</b>	2,0	103	BMM <D7N>		07.09 →		<b>0 414 720 362</b>	<b>0 986 441 567</b>
<b>Jetta</b>								
<b>1.9 TDI [1K2]</b>	1,9	74/77	BLS <D3W>; BRM		01.05 →		<b>0 414 720 363</b>	<b>0 986 441 568</b>
		77	BKC		09.05-02.06			<b>0 986 441 559</b>
			BXE <D3W>		03.06-10.10			<b>0 986 441 559</b>
<b>2.0 TDI [1K2]</b>	2,0	100/103	AZV; BKD		08.05-06.08		<b>0 414 720 454</b>	<b>0 986 441 566</b>
		103	BMM		10.05-06.08		<b>0 414 720 362</b>	<b>0 986 441 567</b>
<b>Jetta V</b>								
<b>1.9 TDI [1K6]</b>	1,9	77	BKC		03.06 →			<b>0 986 441 559</b>
<b>2.0 TDI [1K6]</b>	2,0	103	BKD		03.06 →		<b>0 414 720 454</b>	<b>0 986 441 566</b>
<b>Lupo</b>								
<b>1.2 TDI 3L [6X1]</b>	1,2	45	ANY					
				Fg.Nr. →6E..Y..010 000 →6X..Y..070 000	10.98-04.00		<b>0 414 720 083</b>	<b>0 986 441 552</b>
				Fg.Nr. 6E..1..000 001 →6X..1..000 001 →	05.00-11.00		<b>0 414 720 084</b>	<b>0 986 441 555</b>
			AYZ		11.00-07.05		<b>0 414 720 084</b>	<b>0 986 441 555</b>
<b>1.4 TDI [6X1]</b>	1,4	55	AMF		06.98-07.05		<b>0 414 720 085</b>	<b>0 986 441 551</b>
<b>New Beetle</b>								
<b>1.9 TDI [1C1/9C1]</b>	1,9	74	ATD		10.00-06.05		<b>0 414 720 087</b>	<b>0 986 441 556</b>
		74/77	BEW; BSW <D3W>		06.03 →			<b>0 986 441 559</b>
<b>New Beetle Cabriolet</b>								
<b>1.9 TDI [1Y7]</b>	1,9	74/77	AXR; BSW <D3W>		06.03-09.10			<b>0 986 441 559</b>
<b>Passat</b>								
<b>1.9 TDI [3B2]</b>	1,9	74	AVB		02.00-11.00		<b>0 414 720 087</b>	<b>0 986 441 556</b>
TDI [3B3]	1,9	74	AVB		10.00-05.05		<b>0 414 720 087</b>	<b>0 986 441 556</b>
		96	AVF					
				Fg.Nr. →3B..2..290 300	10.00-12.01		<b>0 414 720 089</b>	<b>0 986 441 557</b>
				Fg.Nr. 3B..2..290 301 →	01.02-05.05		<b>0 414 720 266</b>	<b>0 986 441 560</b>
			AWX					
				Fg.Nr. →3B..2..290 300	10.00-12.01		<b>0 414 720 089</b>	<b>0 986 441 557</b>
				Fg.Nr. 3B..2..290 301 →	01.02-05.05		<b>0 414 720 266</b>	<b>0 986 441 560</b>
TDI [3C2]	1,9	77	BKC		03.05-02.06			<b>0 986 441 559</b>
			BLS		03.05-11.08		<b>0 414 720 363</b>	<b>0 986 441 568</b>
			BXE		02.06-11.08			<b>0 986 441 559</b>
TDI, TDI syncro [3B2]	1,9	85	AJM; ATJ		01.98-11.00		<b>0 414 720 085</b>	<b>0 986 441 551</b>
TDI 4 Motion [3B3]	1,9	96	AVF					
				Fg.Nr. →3B..2..300 000	10.00-12.01		<b>0 414 720 089</b>	<b>0 986 441 557</b>
				Fg.Nr. 3B..2..300 001 →	01.02-05.05		<b>0 414 720 266</b>	<b>0 986 441 560</b>
<b>2.0 TDI [3B3]</b>	2,0	100	BGW		11.03-05.05		<b>0 414 720 272</b>	<b>0 986 441 569</b>
			BHW		11.03-05.05		<b>0 414 720 277</b>	<b>0 986 441 572</b>
TDI, TDI 4 Motion [3C2]	2,0	103	BMP		03.05-06.08		<b>0 414 720 362</b>	<b>0 986 441 567</b>
<b>Passat Variant</b>								
<b>1.9 TDI [3B5]</b>	1,9	74	AVB		02.00-11.00		<b>0 414 720 087</b>	<b>0 986 441 556</b>
TDI [3B6]	1,9	74	AVB		10.00-05.05		<b>0 414 720 087</b>	<b>0 986 441 556</b>
		96	AVF					
				Fg.Nr. →3B..2..290 300	10.00-12.01		<b>0 414 720 089</b>	<b>0 986 441 557</b>
				Fg.Nr. 3B..2..290 301 →	01.02-05.05		<b>0 414 720 266</b>	<b>0 986 441 560</b>





<b>1.9</b> TDI [3B6]	1,9	96	AWX	Fg.Nr. →3B..2..290 300	10.00-12.01	<b>0 414 720 089</b>	<b>0 986 441 557</b>
				Fg.Nr. 3B..2..290 301→	01.02-05.05	<b>0 414 720 266</b>	<b>0 986 441 560</b>
TDI [3C5]	1,9	77	BKC	08.05-02.06		<b>0 986 441 559</b>	
			BLS	08.05-11.08	<b>0 414 720 363</b>	<b>0 986 441 568</b>	
			BXE	02.06-06.08		<b>0 986 441 559</b>	
TDI, TDI syncro [3B5]	1,9	85	AJM; ATJ	03.99-11.00		<b>0 414 720 085</b>	<b>0 986 441 551</b>
TDI 4 Motion [3B6]	1,9	96	AVF	Fg.Nr. →3B..2..300 000	10.00-12.01	<b>0 414 720 089</b>	<b>0 986 441 557</b>
				Fg.Nr. 3B..2..300 001→	01.02-05.05	<b>0 414 720 266</b>	<b>0 986 441 560</b>
<b>2.0</b> TDI [3B6]	2,0	100	BGW	11.03-05.05		<b>0 414 720 272</b>	<b>0 986 441 569</b>
TDI, TDI 4 Motion [3C5]	2,0	103	BMP	08.05-06.08		<b>0 414 720 362</b>	<b>0 986 441 567</b>
<b>Phaeton</b>							
<b>5.0</b> TDI 4 Motion [3D]	5,0	230	AJS	11.02-10.06		<b>0 414 720 270</b>	<b>0 986 441 565</b>
<b>Polo</b>							
<b>1.4</b> TDI [6N2]	1,4	55	AMF	10.99-09.01		<b>0 414 720 085</b>	<b>0 986 441 551</b>
TDI [9N1]	1,4	55	AMF	09.01-05.05		<b>0 414 720 085</b>	<b>0 986 441 551</b>
			BAY	09.01-05.05		<b>0 986 441 559</b>	
TDI [9N2]	1,4	55	BAY	07.03-05.07		<b>0 986 441 559</b>	
TDI [9N3]	1,4	51	BWB	10.05-12.09		<b>0 414 720 364</b>	<b>0 986 441 577</b>
			51/58 BNM; BNV	04.05-12.09		<b>0 414 720 363</b>	<b>0 986 441 568</b>
			59 BMS	10.05-12.09		<b>0 414 720 364</b>	<b>0 986 441 577</b>
TDI [9N4]	1,4	58	BNV	04.05→		<b>0 414 720 363</b>	<b>0 986 441 568</b>
TDI [9V4]	1,4	55	AMF	10.02-12.03		<b>0 414 720 085</b>	<b>0 986 441 551</b>
<b>1.9</b> TDI	1,9	74	ATD	07.02-07.06		<b>0 414 720 087</b>	<b>0 986 441 556</b>
			TDI [9N1]	1,9	74	ATD	09.01-05.05
			AXR			09.01-05.05	
			96	ASZ	11.03-05.05	<b>0 414 720 089</b>	<b>0 986 441 557</b>
				BLT	05.04-05.05	<b>0 414 720 266</b>	<b>0 986 441 560</b>
TDI [9N2]	1,9	74	ATD	07.03-05.07		<b>0 414 720 087</b>	<b>0 986 441 556</b>
TDI [9N3]	1,9	74	ATD	04.05-12.09		<b>0 414 720 087</b>	<b>0 986 441 556</b>
			AXR	04.05-12.09		<b>0 986 441 559</b>	
			BMT	05.06-12.09	<b>0 414 720 363</b>	<b>0 986 441 568</b>	
			96	ASZ	04.05-12.09	<b>0 414 720 089</b>	<b>0 986 441 557</b>
				BLT	04.05-12.09	<b>0 414 720 266</b>	<b>0 986 441 560</b>
<b>Polo Sedan</b>							
<b>1.9</b> TDI	1,9	74	ATD	11.02-07.06		<b>0 414 720 087</b>	<b>0 986 441 556</b>
<b>Sharan</b>							
<b>1.9</b> TDI [7M8]	1,9	66	ANU	03.99-02.00		<b>0 414 720 086</b>	<b>0 986 441 553</b>
TDI [7M9, 7M6]	1,9	66	ANU	04.00-03.10		<b>0 414 720 086</b>	<b>0 986 441 553</b>
			96	ASZ	11.02-03.10	<b>0 414 720 266</b>	<b>0 986 441 560</b>
TDI, TDI 4 Motion [7M9, 7M6]	1,9	85	AUY	05.00-03.10		<b>0 414 720 088</b>	
			BVK	11.05-03.10	<b>0 414 720 364</b>	<b>0 986 441 577</b>	
<b>2.0</b> TDI [7M9, 7M6]	2,0	100/103	BRT; BVH	11.05-03.10		<b>0 414 720 279</b>	<b>0 986 441 574</b>
<b>Touareg</b>							
<b>2.5</b> TDI [7LA]	2,5	120/128	BAC; BLK	Fg.Nr. →7L..5..060 000	01.03-12.04	<b>0 414 720 260</b>	<b>0 986 441 561</b>
				Fg.Nr. 7L..5..060 001→	01.05-11.06	<b>0 414 720 278</b>	<b>0 986 441 573</b>
				BPD; BPE	01.06-11.06	<b>0 414 720 278</b>	<b>0 986 441 573</b>
TDI [7L6]	2,5	120/128	BPD; BPE	12.06-05.10		<b>0 414 720 278</b>	<b>0 986 441 573</b>
<b>5.0</b> TDI [7L6]	5,0	230	BLE	12.06-05.10		<b>0 414 720 361</b>	<b>0 986 441 576</b>
			258	CBWA	08.07-05.10	<b>0 414 720 359</b>	<b>0 986 441 578</b>
<b>50</b> TDI [7LA]	5,0	230	AYH	Fg.Nr. →7L..3..020 000	11.02-05.03	<b>0 414 720 260</b>	<b>0 986 441 561</b>
				Fg.Nr. 7L..4..000 001→	06.03-11.06	<b>0 414 720 270</b>	<b>0 986 441 565</b>
				BKW	11.03-11.04	<b>0 414 720 275</b>	<b>0 986 441 563</b>
				BLE	11.04-05.05	<b>0 414 720 305</b>	<b>0 986 441 576</b>
					06.05-11.06	<b>0 414 720 361</b>	<b>0 986 441 576</b>
				BWF	02.06-11.06	<b>0 414 720 361</b>	<b>0 986 441 576</b>





◀ VW

<b>Touran</b>									
<b>1.9</b> TDI [1T1]	1,9	66	BXJ		07.06-11.06	<b>0 414 720 363</b>	<b>0 986 441 568</b>		
		66/77	BRU; BXE; BXF		06.05-11.06		<b>0 986 441 559</b>		
		74/77	AVQ; BKC		02.03-02.06		<b>0 986 441 559</b>		
		77	BLS		11.05-11.06	<b>0 414 720 363</b>	<b>0 986 441 568</b>		
TDI [1T2]	1,9	66	BXJ		11.06-05.10	<b>0 414 720 363</b>	<b>0 986 441 568</b>		
		66/77	BXE; BXF		11.06-05.10		<b>0 986 441 559</b>		
		77	BLS		11.06-05.10	<b>0 414 720 363</b>	<b>0 986 441 568</b>		
<b>2.0</b> TDI [1T1]	2,0	100	AZV						
			Fg.Nr. →1T..4..200 000		02.03-04.04	<b>0 414 720 453</b>	<b>0 986 441 580</b>		
			Fg.Nr. 1T..4..200 001→		05.04-11.06	<b>0 414 720 454</b>	<b>0 986 441 566</b>		
		103	BKD	Fg.Nr. →1T..4..133 827		08.03-02.04	<b>0 414 720 453</b>	<b>0 986 441 580</b>	
				Fg.Nr. 1T..4..133 828→1T..4..172 000		03.04-04.04	AG	<b>0 414 720 454</b>	<b>0 986 441 566</b>
							GS	<b>0 414 720 453</b>	<b>0 986 441 580</b>
				Fg.Nr. 1T..4..172 001→		05.04-11.06	<b>0 414 720 454</b>	<b>0 986 441 566</b>	
				BMM		06.05-11.06	<b>0 414 720 362</b>	<b>0 986 441 567</b>	
TDI [1T2]	2,0	100/103	AZV; BKD		11.06-05.10	<b>0 414 720 454</b>	<b>0 986 441 566</b>		
		103	BMM		11.06-05.10	<b>0 414 720 362</b>	<b>0 986 441 567</b>		





l/ccm



kW/(PS)



Typ



## SEAT

**Alhambra**

2.0 TDI, TDI 4WD [710]	2,0	100/103/ 125	CFFA; CFFB; CFFB <D91>; CFGB	05.10→	<b>F 01C 600 105</b>
------------------------	-----	-----------------	------------------------------	--------	----------------------

## VW (VOLKSWAGEN)

**Passat**

2.0 TDI [3C2]	2,0	105	CBAC <D92>	11.08-11.10	<b>F 01C 600 105</b>
TDI, TDI 4 Motion [362]	2,0	100/103/ 125	CFFA <D94>; CFFB <D91>; CFGB <D93>; CLLA	08.10→	<b>F 01C 600 105</b>

**Passat CC**

2.0 TDI, TDI 4 Motion [357]	2,0	103/105	CBAC; CFFB <D91>	05.09→	<b>F 01C 600 105</b>
-----------------------------	-----	---------	------------------	--------	----------------------

**Passat Variant**

2.0 TDI [3C5]	2,0	105	CBAC <D92>	11.08-11.10	<b>F 01C 600 105</b>
TDI, TDI 4 Motion [365]	2,0	100/103/ 125	CFFA <D94>; CFFB <D91>; CFGB <D93>; CLLA	08.10→	<b>F 01C 600 105</b>

**Sharan**

2.0 TDI, TDI 4 Motion [7N1]	2,0	100/103/ 125	CFFA <D94>; CFFB <D91>; CFGB <D93>	05.10→	<b>F 01C 600 105</b>
-----------------------------	-----	-----------------	------------------------------------	--------	----------------------





**DAF**

CF								
75 .250, .310, .360	9,2	183/228/265	PR 183 <Euro 4/5/EEV>; PR 228 <Euro 3/4/5/EEV>; PR 265 <Euro 4/5/EEV>	04.06→	TW	0 444 010 021	0 986 44D 002	
85 .360, .410, .460, .510	12,9	265/300/340/375	MX 265, 300 <Euro 3/4/5/EEV>; MX 340, 375 <Euro 4/5/EEV>	04.06→	TW	0 444 010 021	0 986 44D 002	
XF								
95 .460	12,9	340	MX 340 <Euro 4>	11.03-10.05	TW		0 986 44D 002	
105 .410, .460, .510	12,9	300/340/375	MX 300, 340 <Euro 3/4/5>; MX 375 <Euro 4/5>	01.06→	TW	0 444 010 021	0 986 44D 002	
.560	12,9	410	MX 410 <Euro 3/4>	02.04-12.05	TW		0 986 44D 002	

**IVECO**

EuroCargo								
75 E 14, 16, 18 [03]	3,9	103/118/130	F4AE3481B*...; F4AE3481C...; F4AE3481D... Fg.Nr. →3575388 Fg.Nr. 2575389→	09.05→ 09.05→		0 444 022 019 0 444 022 021	0 986 44D 106	
80 E 18 [03]	3,9	130	F4AE3481B... Fg.Nr. →3575388 Fg.Nr. 2575389→	09.05→ 09.05→		0 444 022 019 0 444 022 021	0 986 44D 106	
100 E 18 [03]	3,9	130	F4AE3481B... Fg.Nr. →3575388 Fg.Nr. 2575389→	09.06→ 09.06→		0 444 022 019 0 444 022 021	0 986 44D 106	
18, 22 [03]	5,9	135/160	F4AE3681B...; F4AE3681C*... Fg.Nr. →3575388 Fg.Nr. 2575389→	09.05→ 09.05→		0 444 022 019 0 444 022 021	0 986 44D 106	
110 E 22 [03]	5,9	160	F4AE3681B... Fg.Nr. →3575388 Fg.Nr. 2575389→	09.07→ 09.07→		0 444 022 019 0 444 022 021	0 986 44D 106	
120 E 18 [03]	3,9	134	F4AE3481A... Fg.Nr. →3575388 Fg.Nr. 2575389→	09.05→ 09.05→		0 444 022 019 0 444 022 021	0 986 44D 106	
22 [03]	5,9	160	F4AE3681B... Fg.Nr. →3575388 Fg.Nr. 2575389→	09.05→ 09.05→		0 444 022 019 0 444 022 021	0 986 44D 106	
140 E 18 [03]	3,9	134	F4AE3481A... Fg.Nr. →3575388 Fg.Nr. 2575389→	09.05→ 09.05→		0 444 022 019 0 444 022 021	0 986 44D 106	
22, 25, 28 [03]	5,9	160/185/205	F4AE3681B...; F4AE3681D...; F4AE3681E... Fg.Nr. →3575388 Fg.Nr. 2575389→	09.05→ 09.05→		0 444 022 019 0 444 022 021	0 986 44D 106	
150 E 18 [03]	3,9	134	F4AE3481A*... Fg.Nr. →3575388 Fg.Nr. 2575389→	09.05→ 09.05→		0 444 022 019 0 444 022 021	0 986 44D 106	
25, 28, 30 [03]	5,9	185/205/220	F4AE3681A*...; F4AE3681D*...; F4AE3681E*... Fg.Nr. →3575388 Fg.Nr. 2575389→	09.05→ 09.05→		0 444 022 019 0 444 022 021	0 986 44D 106	
160 E 18 [03]	3,9	134	F4AE3481A*... Fg.Nr. →3575388 Fg.Nr. 2575389→	09.05→ 09.05→		0 444 022 019 0 444 022 021	0 986 44D 106	
22, 25, 28, 30 [03]	5,9	160/185/205/220	F4AE3681A*...; F4AE3681B*...; F4AE3681D*...; F4AE3681E*... Fg.Nr. →3575388 Fg.Nr. 2575389→	09.05→ 09.05→		0 444 022 019 0 444 022 021	0 986 44D 106	
180 E 25, 28 [03]	5,9	185/205	F4AE3681D*...; F4AE3681E*... Fg.Nr. →3575388 Fg.Nr. 2575389→	09.05→ 09.05→		0 444 022 019 0 444 022 021	0 986 44D 106	







Stralis									
<b>L 190 S</b> 42, 45 [07]	10,3	309/331	F3AE3681A*...; F3AE3681D*...	Fg.Nr. →3575388	04.07→	<b>0 444 022 019</b>	<b>0 986 44D 106</b>		
				Fg.Nr. 2575389→	04.07→	<b>0 444 022 021</b>			
50 [07]	12,9	368	F3BE3681B*...	Fg.Nr. →3575388	04.07→	<b>0 444 022 019</b>	<b>0 986 44D 106</b>		
				Fg.Nr. 2575389→	04.07→	<b>0 444 022 021</b>			
<b>L 260 S</b> 50, 56 [07]	12,9	368/412	F3BE3681A*...; F3BE3681B*...	Fg.Nr. →3575388	04.07→	<b>0 444 022 019</b>	<b>0 986 44D 106</b>		
				Fg.Nr. 2575389→	04.07→	<b>0 444 022 021</b>			
<b>L 440 S</b> 42, 45 [07]	10,3	309/331	F3AE3681A*...; F3AE3681D*...	Fg.Nr. →3575388	04.07→	<b>0 444 022 019</b>	<b>0 986 44D 106</b>		
				Fg.Nr. 2575389→	04.07→	<b>0 444 022 021</b>			
50, 56 [07]	12,9	368/412	F3BE3681A*...; F3BE3681B*...	Fg.Nr. →3575388	04.07→	<b>0 444 022 019</b>	<b>0 986 44D 106</b>		
				Fg.Nr. 2575389→	04.07→	<b>0 444 022 021</b>			
<b>N 190 S</b> 31, 33, 36 [07]	7,8	228/243/ 265	F2BE3681A*...; F2BE3681B*...; F2BE3681C*...	Fg.Nr. →3575388	04.07→	<b>0 444 022 019</b>	<b>0 986 44D 106</b>		
				Fg.Nr. 2575389→	04.07→	<b>0 444 022 021</b>			
<b>N 260 S</b> 31, 33, 36 [07]	7,8	228/243/ 265	F2BE3681A*...; F2BE3681B*...; F2BE3681C*...	Fg.Nr. →3575388	04.07→	<b>0 444 022 019</b>	<b>0 986 44D 106</b>		
				Fg.Nr. 2575389→	04.07→	<b>0 444 022 021</b>			
<b>N 440 S</b> 33, 36 [07]	7,8	243/265	F2BE3681A*...; F2BE3681B*...	Fg.Nr. →3575388	04.07→	<b>0 444 022 019</b>	<b>0 986 44D 106</b>		
				Fg.Nr. 2575389→	04.07→	<b>0 444 022 021</b>			
<b>190 S</b> 31, 33, 36	7,8	228/243/ 265	F2BE3681A*...; F2BE3681B*...; F2BE3681C*...	Fg.Nr. →3575388	04.06→	<b>0 444 022 019</b>	<b>0 986 44D 106</b>		
				Fg.Nr. 2575389→	04.06→	<b>0 444 022 021</b>			
42, 45	10,3	309/331	F3AE3681A*...; F3AE3681D*...	Fg.Nr. →3575388	04.06→	<b>0 444 022 019</b>	<b>0 986 44D 106</b>		
				Fg.Nr. 2575389→	04.06→	<b>0 444 022 021</b>			
50	12,9	368	F3BE3681B*...	Fg.Nr. →3575388	04.06→	<b>0 444 022 019</b>	<b>0 986 44D 106</b>		
				Fg.Nr. 2575389→	04.06→	<b>0 444 022 021</b>			
<b>260 S</b> 31, 33, 36	7,8	228/243/ 265	F2BE3681A*...; F2BE3681B*...; F2BE3681C*...	Fg.Nr. →3575388	04.06→	<b>0 444 022 019</b>	<b>0 986 44D 106</b>		
				Fg.Nr. 2575389→	04.06→	<b>0 444 022 021</b>			
42 Cube, 45 Cube [07]	10,3	309/331	F3AE3681A*...; F3AE3681D*...	Fg.Nr. →3575388	04.07→	<b>0 444 022 019</b>	<b>0 986 44D 106</b>		
				Fg.Nr. 2575389→	04.07→	<b>0 444 022 021</b>			
42, 45	10,3	309/331	F3AE3681A*...; F3AE3681D*...	Fg.Nr. →3575388	04.06→	<b>0 444 022 019</b>	<b>0 986 44D 106</b>		
				Fg.Nr. 2575389→	04.06→	<b>0 444 022 021</b>			
43	10,5	316	F3AE0681D*...		08.02-03.06	THE	<b>0 444 010 003</b>		
48	13,0	353	F3BE0681E*...		08.02-03.06	THE	<b>0 444 010 003</b>		
50, 56	12,9	368/412	F3BE3681A*...; F3BE3681B*...	Fg.Nr. →3575388	04.06→	<b>0 444 022 019</b>	<b>0 986 44D 106</b>		
				Fg.Nr. 2575389→	04.06→	<b>0 444 022 021</b>			
<b>320 S</b> 36	7,8	265	F2BE3681A*...	Fg.Nr. →3575388	04.06→	<b>0 444 022 019</b>	<b>0 986 44D 106</b>		
				Fg.Nr. 2575389→	04.06→	<b>0 444 022 021</b>			
<b>440 S</b> 33, 36	7,8	243/265	F2BE3681A*...; F2BE3681B*M...	Fg.Nr. →3575388	04.06→	<b>0 444 022 019</b>	<b>0 986 44D 106</b>		
				Fg.Nr. 2575389→	04.06→	<b>0 444 022 021</b>			
42, 45	10,3	309/331	F3AE3681A*...; F3AE3681D*...	Fg.Nr. →3575388	04.06→	<b>0 444 022 019</b>	<b>0 986 44D 106</b>		
				Fg.Nr. 2575389→	04.06→	<b>0 444 022 021</b>			
43	10,5	316	F3AE0681D*...		08.02→	THE	<b>0 444 010 003</b>		
					08.02→		<b>0 444 022 019</b>	<b>0 986 44D 106</b>	
48	13,0	353	F3BE0681E*...	Fg.Nr. →3575388	08.02→		<b>0 444 022 019</b>	<b>0 986 44D 106</b>	
				Fg.Nr. 2575389→	08.02→		<b>0 444 022 021</b>		





◀ IVECO

<b>440 S</b> 50, 56	12,9	368/412	F3BE3681A*...; F3BE3681B*... Fg.Nr. →3575388 Fg.Nr. 2575389→	04.06→ 04.06→	<b>0 444 022 019</b> <b>0 986 44D 106</b> <b>0 444 022 021</b>
<b>Trakker</b>					
<b>N 190 T</b> 31, 33, 36 [07]	7,8	228/243/ 265	F2BE3681A*...; F2BE3681B*...; F2BE3681C*... Fg.Nr. →3575388 Fg.Nr. 2575389→	07.07→ 07.07→	<b>0 444 022 019</b> <b>0 986 44D 106</b> <b>0 444 022 021</b>
41, 45 [07]	13,0	302/331	F3BE3681C*...; F3BE3681D*... Fg.Nr. →3575388 Fg.Nr. 2575389→	07.07→ 07.07→	<b>0 444 022 019</b> <b>0 986 44D 106</b> <b>0 444 022 021</b>
<b>N 260 T</b> 33, 36 [07]	7,8	243/265	F2BE3681A*...; F2BE3681B*... Fg.Nr. →3575388 Fg.Nr. 2575389→	07.07→ 07.07→	<b>0 444 022 019</b> <b>0 986 44D 106</b> <b>0 444 022 021</b>
41, 45, 50 [07]	13,0	302/331/ 368	F3BE3681B*...; F3BE3681C*...; F3BE3681D*... Fg.Nr. →3575388 Fg.Nr. 2575389→	07.07→ 07.07→	<b>0 444 022 019</b> <b>0 986 44D 106</b> <b>0 444 022 021</b>
<b>N 340 T</b> 36 [07]	7,8	265	F2BE3681A*... Fg.Nr. →3575388 Fg.Nr. 2575389→	07.07→ 07.07→	<b>0 444 022 019</b> <b>0 986 44D 106</b> <b>0 444 022 021</b>
41, 45 [07]	13,0	302/331	F3BE3681C*...; F3BE3681D*... Fg.Nr. →3575388 Fg.Nr. 2575389→	07.07→ 07.07→	<b>0 444 022 019</b> <b>0 986 44D 106</b> <b>0 444 022 021</b>
<b>N 380 T</b> 41, 45, 50 [07]	13,0	302/331/ 368	F3BE3681B*...; F3BE3681C*...; F3BE3681D*... Fg.Nr. →3575388 Fg.Nr. 2575389→	07.07→ 07.07→	<b>0 444 022 019</b> <b>0 986 44D 106</b> <b>0 444 022 021</b>
<b>N 400 T</b> 36 [07]	7,8	265	F2BE3681A*... Fg.Nr. →3575388 Fg.Nr. 2575389→	07.07→ 07.07→	<b>0 444 022 019</b> <b>0 986 44D 106</b> <b>0 444 022 021</b>
41, 45, 50 [07]	13,0	302/331/ 368	F3BE3681B*...; F3BE3681C*...; F3BE3681D*... Fg.Nr. →3575388 Fg.Nr. 2575389→	07.07→ 07.07→	<b>0 444 022 019</b> <b>0 986 44D 106</b> <b>0 444 022 021</b>
<b>N 410 T</b> 41, 45, 50 [07]	13,0	302/331/ 368	F3BE3681B*...; F3BE3681C*...; F3BE3681D*... Fg.Nr. →3575388 Fg.Nr. 2575389→	07.07→ 07.07→	<b>0 444 022 019</b> <b>0 986 44D 106</b> <b>0 444 022 021</b>
<b>N 440 T</b> 41, 45, 50 [07]	13,0	302/331/ 368	F3BE3681B*...; F3BE3681C*...; F3BE3681D*... Fg.Nr. →3575388 Fg.Nr. 2575389→	07.07→ 07.07→	<b>0 444 022 019</b> <b>0 986 44D 106</b> <b>0 444 022 021</b>
<b>N 720 T</b> 41, 45, 50 [07]	13,0	302/331/ 368	F3BE3681B*...; F3BE3681C*...; F3BE3681D*... Fg.Nr. →3575388 Fg.Nr. 2575389→	07.07→ 07.07→	<b>0 444 022 019</b> <b>0 986 44D 106</b> <b>0 444 022 021</b>
<b>190 T</b> 31, 33, 36	7,8	228/243/ 265	F2BE3681A*...; F2BE3681B*...; F2BE3681C*... Fg.Nr. →3575388 Fg.Nr. 2575389→	04.06→ 04.06→	<b>0 444 022 019</b> <b>0 986 44D 106</b> <b>0 444 022 021</b>
41, 45	13,0	302/331	F3BE3681C*...; F3BE3681D*... Fg.Nr. →3575388 Fg.Nr. 2575389→	04.06→ 04.06→	<b>0 444 022 019</b> <b>0 986 44D 106</b> <b>0 444 022 021</b>
<b>260 T</b> 33, 36	7,8	243/265	F2BE3681A*...; F2BE3681B*... Fg.Nr. →3575388 Fg.Nr. 2575389→	04.06→ 04.06→	<b>0 444 022 019</b> <b>0 986 44D 106</b> <b>0 444 022 021</b>
41, 45, 50	13,0	302/331/ 368	F3BE3681B*...; F3BE3681C*...; F3BE3681D*... Fg.Nr. →3575388 Fg.Nr. 2575389→	04.06→ 04.06→	<b>0 444 022 019</b> <b>0 986 44D 106</b> <b>0 444 022 021</b>
<b>340 T</b> 36	7,8	265	F2BE3681A*... Fg.Nr. →3575388 Fg.Nr. 2575389→	04.06→ 04.06→	<b>0 444 022 019</b> <b>0 986 44D 106</b> <b>0 444 022 021</b>
41, 45	13,0	302/331	F3BE3681C*...; F3BE3681D*... Fg.Nr. →3575388 Fg.Nr. 2575389→	04.06→ 04.06→	<b>0 444 022 019</b> <b>0 986 44D 106</b> <b>0 444 022 021</b>
<b>380 T</b> 36	7,8	265	F2BE3681A*... Fg.Nr. →3575388 Fg.Nr. 2575389→	04.06→ 04.06→	<b>0 444 022 019</b> <b>0 986 44D 106</b> <b>0 444 022 021</b>





<b>380 T</b> 41, 45, 50	13,0	302/331/368	F3BE3681B*...; F3BE3681C*...; F3BE3681D*... Fg.Nr. →3575388 Fg.Nr. 2575389→	04.06→ 04.06→	<b>0 444 022 019</b> <b>0 986 44D 106</b> <b>0 444 022 021</b>
<b>400 T</b> 36	7,8	265	F2BE3681A*... Fg.Nr. →3575388 Fg.Nr. 2575389→	04.06→ 04.06→	<b>0 444 022 019</b> <b>0 986 44D 106</b> <b>0 444 022 021</b>
41, 50	13,0	302/368	F3BE3681B*...; F3BE3681D*... Fg.Nr. →3575388 Fg.Nr. 2575389→	04.06→ 04.06→	<b>0 444 022 019</b> <b>0 986 44D 106</b> <b>0 444 022 021</b>
<b>410 T</b> 36	7,8	265	F2BE3681A*... Fg.Nr. →3575388 Fg.Nr. 2575389→	04.06→ 04.06→	<b>0 444 022 019</b> <b>0 986 44D 106</b> <b>0 444 022 021</b>
41, 45, 50	13,0	302/331/368	F3BE3681B*...; F3BE3681C*...; F3BE3681D*... Fg.Nr. →3575388 Fg.Nr. 2575389→	04.06→ 04.06→	<b>0 444 022 019</b> <b>0 986 44D 106</b> <b>0 444 022 021</b>
<b>440 T</b> 41, 45, 50	13,0	302/331/368	F3BE3681B*...; F3BE3681C*...; F3BE3681D*... Fg.Nr. →3575388 Fg.Nr. 2575389→	04.06→ 04.06→	<b>0 444 022 019</b> <b>0 986 44D 106</b> <b>0 444 022 021</b>
<b>720 T</b> 41, 45, 50	13,0	302/331/368	F3BE3681B*...; F3BE3681C*...; F3BE3681D*... Fg.Nr. →3575388 Fg.Nr. 2575389→	04.06→ 04.06→	<b>0 444 022 019</b> <b>0 986 44D 106</b> <b>0 444 022 021</b>

MAN

**TGA**

<b>18.320</b> F, FL, FC, FK, FL	10,5	235	D 2066 LF20 <V5500, Euro 5>; D 2066 LF28 <Euro 5/OBD1>; D 2066 LF30 <Euro 5/OBD1>	04.07-08.08 TW	<b>0 444 010 013</b> <b>0 444 010 015</b>
<b>18.360</b> F, FL	10,5	265	D 2066 LF19 <V5500, Euro 5>; D 2066 LF27 <Euro 5/OBD1>; D 2066 LF29 <V5500, Euro 5>	04.07-08.08 TW	<b>0 444 010 013</b> <b>0 444 010 015</b>
<b>18.400</b> F, FL	10,5	294	D 2066 LF18 <Euro 5/OBD1>	04.08-08.08 TW	<b>0 444 010 013</b> <b>0 444 010 015</b>
F, FL, FC, FK, FL	10,5	294	D 2066 LF24 <Euro 5/OBD1>; D 2066 LF26 <Euro 5/OBD1>	01.06-08.08 TW	<b>0 444 010 013</b> <b>0 444 010 015</b>
FC, FK, FL	10,5	294	D 2066 LF22 <V5500, Euro 5>	01.06-11.06 TW	<b>0 444 010 006</b> <b>0 444 010 013</b>
<b>18.440</b> F, FL	10,5	321/324	D 2066 LF23 <Euro 5/OBD1>; D 2066 LF25 <Euro 5/OBD1>	02.07-08.08 TW	<b>0 444 010 013</b> <b>0 444 010 015</b>
		324	D 2066 LF17 <Euro 5/OBD1>	04.08-08.08 TW	<b>0 444 010 013</b> <b>0 444 010 015</b>
FC, FK, FL	10,5	321	D 2066 LF21 <V5500, Euro 5>	01.06-11.06 TW	<b>0 444 010 006</b> <b>0 444 010 013</b>
<b>18.480</b> F, FL	12,4	353	D 2676 LF12 <V7300, Euro 5 OBD>; D 2676 LF14 <V7300, Euro 5>; D 2676 LF16 <V7300, Euro 5>	07.06-08.08 TW	<b>0 444 010 013</b> <b>0 444 010 015</b>
<b>18.540</b> F, FL	12,4	397	D 2676 LF11 <Euro 5/OBD1>; D 2676 LF13 <V7300, Euro 5>; D 2676 LF15 <V7300, Euro 5>	02.07-08.08 TW	<b>0 444 010 013</b> <b>0 444 010 015</b>
<b>24.360</b> DF	10,5	265	D 2066 LF19 <V5500, Euro 5>; D 2066 LF27 <Euro 5/OBD1>; D 2066 LF29 <V5500, Euro 5>	04.07-08.08 TW	<b>0 444 010 013</b> <b>0 444 010 015</b>
<b>24.400</b> DF	10,5	294	D 2066 LF18 <Euro 5/OBD1>	04.08-08.08 TW	<b>0 444 010 013</b> <b>0 444 010 015</b>
			D 2066 LF22 <V5500, Euro 5>	07.06-11.06 TW	<b>0 444 010 006</b> <b>0 444 010 013</b>
			D 2066 LF24 <Euro 5/OBD1>; D 2066 LF26 <Euro 5/OBD1>	07.06-08.08 TW	<b>0 444 010 013</b> <b>0 444 010 015</b>
<b>24.440</b> DF	10,5	321	D 2066 LF21 <V5500, Euro 5>	07.06-11.06 TW	<b>0 444 010 006</b> <b>0 444 010 013</b>
		324	D 2066 LF17 <Euro 5/OBD1>	04.08-08.08 TW	<b>0 444 010 013</b> <b>0 444 010 015</b>
DF, FD	10,5	321/324	D 2066 LF23 <Euro 5/OBD1>; D 2066 LF25 <Euro 5/OBD1>	02.07-08.08 TW	<b>0 444 010 013</b> <b>0 444 010 015</b>
<b>24.480</b> DF	12,4	353	D 2676 LF12 <V7300, Euro 5 OBD>; D 2676 LF14 <V7300, Euro 5>; D 2676 LF16 <V7300, Euro 5>	07.06-08.08 TW	<b>0 444 010 013</b> <b>0 444 010 015</b>













◀ MAN

<b>24.540</b> DF	12,4	397	D 2676 LF11 <Euro 5/OBD1>; D 2676 LF13 <V7300, Euro 5>; D 2676 LF15 <V7300, Euro 5>	02.07-08.08	TW	<b>0 444 010 013</b> <b>0 444 010 015</b>
<b>26.320</b> FD, FH, FN, FV	10,5	235	D 2066 LF20 <V5500, Euro 5>; D 2066 LF28 <Euro 5/OBD1>; D 2066 LF30 <Euro 5/OBD1>	04.07-08.08	TW	<b>0 444 010 013</b> <b>0 444 010 015</b>
<b>26.360</b> FD, FH, FN, FV	10,5	265	D 2066 LF19 <V5500, Euro 5>; D 2066 LF27 <Euro 5/OBD1>; D 2066 LF29 <V5500, Euro 5>	04.07-08.08	TW	<b>0 444 010 013</b> <b>0 444 010 015</b>
<b>26.400</b> FD, FH, FN, FV	10,5	294	D 2066 LF18 <Euro 5/OBD1>	04.08-08.08	TW	<b>0 444 010 013</b> <b>0 444 010 015</b>
			D 2066 LF22 <V5500, Euro 5>	01.06-11.06	TW	<b>0 444 010 006</b> <b>0 444 010 013</b>
			D 2066 LF24 <Euro 5/OBD1>; D 2066 LF26 <Euro 5/OBD1>	01.06-08.08	TW	<b>0 444 010 013</b> <b>0 444 010 015</b>
<b>26.440</b> F, FL, FD, FH, FN, FV	10,5	321/324	D 2066 LF23 <Euro 5/OBD1>; D 2066 LF25 <Euro 5/OBD1>	02.07-08.08	TW	<b>0 444 010 013</b> <b>0 444 010 015</b>
FD, FH, FN, FV	10,5	321	D 2066 LF17 <Euro 5/OBD1>	04.08-08.08	TW	<b>0 444 010 013</b> <b>0 444 010 015</b>
			D 2066 LF21 <V5500, Euro 5>	01.06-11.06	TW	<b>0 444 010 006</b> <b>0 444 010 013</b>
<b>26.480</b> FD, FH, FN, FV	12,4	353	D 2676 LF12 <V7300, Euro 5>; D 2676 LF14 <V7300, Euro 5>; D 2676 LF16 <V7300, Euro 5>	07.06-08.08	TW	<b>0 444 010 013</b> <b>0 444 010 015</b>
<b>26.540</b> FD, FH, FN, FV	12,4	397	D 2676 LF11 <Euro 5/OBD1>; D 2676 LF13 <V7300, Euro 5>; D 2676 LF15 <V7300, Euro 5>	02.07-08.08	TW	<b>0 444 010 013</b> <b>0 444 010 015</b>
<b>28.320</b> FN	10,5	235/236	D 2066 LF20 <V5500, Euro 5>; D 2066 LF28 <Euro 5/OBD1>; D 2066 LF30 <Euro 5/OBD1>	04.07-08.08	TW	<b>0 444 010 013</b> <b>0 444 010 015</b>
<b>28.360</b> FN	10,5	265	D 2066 LF19 <V5500, Euro 5>; D 2066 LF27 <Euro 5/OBD1>; D 2066 LF29 <V5500, Euro 5>	04.07-08.08	TW	<b>0 444 010 013</b> <b>0 444 010 015</b>
<b>28.400</b> FN	10,5	294	D 2066 LF18 <Euro 5/OBD1>	04.08-08.08	TW	<b>0 444 010 013</b> <b>0 444 010 015</b>
			D 2066 LF22 <V5500, Euro 5>	07.06-11.06	TW	<b>0 444 010 006</b> <b>0 444 010 013</b>
			D 2066 LF24 <Euro 5/OBD1>; D 2066 LF26 <Euro 5/OBD1>	07.06-08.08	TW	<b>0 444 010 013</b> <b>0 444 010 015</b>
<b>28.440</b> DF	10,5	321	D 2066 LF21 <V5500, Euro 5>	01.06-11.06	TW	<b>0 444 010 006</b> <b>0 444 010 013</b>
FN	10,5	321/324	D 2066 LF23 <Euro 5/OBD1>; D 2066 LF25 <Euro 5/OBD1>	02.07-08.08	TW	<b>0 444 010 013</b> <b>0 444 010 015</b>
		324	D 2066 LF17 <Euro 5/OBD1>	04.08-08.08	TW	<b>0 444 010 013</b> <b>0 444 010 015</b>
<b>28.480</b> FN	12,4	353	D 2676 LF12 <V7300, Euro 5 OBD>	07.06-09.07		<b>0 444 010 013</b>
			D 2676 LF14 <V7300, Euro 5>; D 2676 LF16 <V7300, Euro 5>	10.07-08.08	TW	<b>0 444 010 013</b> <b>0 444 010 015</b>
<b>28.540</b> FN	12,4	397	D 2676 LF11 <Euro 5/OBD1>	02.07-09.07		<b>0 444 010 013</b>
			D 2676 LF13 <V7300, Euro 5>; D 2676 LF15 <V7300, Euro 5>	10.07-08.08	TW	<b>0 444 010 013</b> <b>0 444 010 015</b>
<b>41.540</b> FV	12,4	397	D 2676 LF11 <Euro 5/OBD1>	04.07-09.07		<b>0 444 010 013</b>
			D 2676 LF13 <V7300, Euro 5>	10.07-07.08	TW	<b>0 444 010 013</b> <b>0 444 010 015</b>

TGS

<b>18.320</b>	10,5	235	D 2066 LF20 <Euro 5/OBD1>; D 2066 LF28 <Euro 5/OBD1>	10.07→	TW	<b>0 444 010 013</b> <b>0 444 010 015</b>
			D 2066 LF43 <Euro 5/OBD2>; D 2066 LF60 <Euro 5/EEV/OBD2>	09.09→		<b>0 444 010 026</b>
<b>18.360</b>	10,5	265	D 2066 LF19 <Euro 5/OBD1>; D 2066 LF27 <Euro 5/OBD1>	10.07→	TW	<b>0 444 010 013</b> <b>0 444 010 015</b>
			D 2066 LF42 <Euro 5/OBD2>; D 2066 LF59 <Euro 5/EEV/OBD2>	09.09→		<b>0 444 010 026</b>
<b>18.400</b>	10,5	294	D 2066 LF18 <Euro 5/OBD1>; D 2066 LF26 <Euro 5/OBD1>	10.07→	TW	<b>0 444 010 013</b> <b>0 444 010 015</b>
			D 2066 LF41 <Euro 5/OBD2>; D 2066 LF58 <Euro 5/EEV/OBD2>	09.09→		<b>0 444 010 026</b>
<b>18.440</b>	10,5	324	D 2066 LF17 <Euro 5/OBD1>; D 2066 LF25 <Euro 5/OBD1>	10.07→	TW	<b>0 444 010 013</b> <b>0 444 010 015</b>



									
<b>18.440</b>		10,5	324	D 2066 LF40 <Euro 5/OBD2>; D 2066 LF57 <Euro 5/EEV/OBD2>	09.09→				<b>0 444 010 026</b>
<b>18.480</b>		12,4	353	D 2676 LF07 <Euro 5/OBD2>	09.09→				<b>0 444 010 026</b>
				D 2676 LF18 <Euro 5/EEV/OBD2>	09.09→				<b>0 444 010 026</b>
	, F, FL	12,4	353	D 2676 LF14 <Euro 5/OBD1>; D 2676 LF16 <Euro 5/OBD1>	10.07→		TW		<b>0 444 010 013</b>
									<b>0 444 010 015</b>
<b>18.540</b>		12,4	397	D 2676 LF06 <Euro 5/OBD2>	09.09→				<b>0 444 010 026</b>
				D 2676 LF13 <Euro 5/OBD1>; D 2676 LF15 <Euro 5/OBD1>	10.07→		TW		<b>0 444 010 013</b>
									<b>0 444 010 015</b>
<b>19.360 WW</b>		10,5	265	D 2066 LF64 <Euro 4/OBD2>	02.11→				<b>0 444 010 026</b>
<b>19.400 WW</b>		10,5	294	D 2066 LF63 <Euro 4/OBD2>	02.11→				<b>0 444 010 026</b>
<b>19.440 WW</b>		10,5	324	D 2066 LF62 <Euro 4/OBD2>	02.11→				<b>0 444 010 026</b>
<b>19.480 WW</b>		12,4	353	D 2676 LF20 <Euro 4/OBD2>	02.11→				<b>0 444 010 015</b>
<b>24.320</b>		10,5	235	D 2066 LF20 <Euro 5/OBD1>; D 2066 LF28 <Euro 5/OBD1>	10.07→		TW		<b>0 444 010 013</b>
									<b>0 444 010 015</b>
				D 2066 LF43 <Euro 5/OBD2>; D 2066 LF60 <Euro 5/EEV/OBD2>	09.09→				<b>0 444 010 026</b>
<b>24.360</b>		10,5	265	D 2066 LF19 <Euro 5/OBD1>; D 2066 LF27 <Euro 5/OBD1>	10.07→		TW		<b>0 444 010 013</b>
									<b>0 444 010 015</b>
				D 2066 LF42 <Euro 5/OBD2>; D 2066 LF59 <Euro 5/EEV/OBD2>	09.09→				<b>0 444 010 026</b>
<b>24.400</b>		10,5	294	D 2066 LF18 <Euro 5/OBD1>; D 2066 LF26 <Euro 5/OBD1>	10.07→		TW		<b>0 444 010 013</b>
									<b>0 444 010 015</b>
				D 2066 LF41 <Euro 5/OBD2>; D 2066 LF58 <Euro 5/EEV/OBD2>	09.09→				<b>0 444 010 026</b>
<b>24.440</b>		10,5	324	D 2066 LF17 <Euro 5/OBD1>; D 2066 LF25 <Euro 5/OBD1>	10.07→		TW		<b>0 444 010 013</b>
									<b>0 444 010 015</b>
				D 2066 LF40 <Euro 5/OBD2>; D 2066 LF57 <Euro 5/EEV/OBD2>	09.09→				<b>0 444 010 026</b>
<b>24.480</b>		12,4	353	D 2676 LF07 <Euro 5/OBD2>	09.09→				<b>0 444 010 026</b>
				D 2676 LF18 <Euro 5/EEV/OBD2>	09.09→				<b>0 444 010 026</b>
	, DF	12,4	353	D 2676 LF14 <Euro 5/OBD1>; D 2676 LF16 <Euro 5/OBD1>	10.07→		TW		<b>0 444 010 013</b>
									<b>0 444 010 015</b>
<b>24.540</b>		12,4	397	D 2676 LF06 <Euro 5/OBD2>	09.09→				<b>0 444 010 026</b>
<b>26.320</b>		10,5	235	D 2066 LF20 <Euro 5/OBD1>; D 2066 LF28 <Euro 5/OBD1>	10.07→		TW		<b>0 444 010 013</b>
									<b>0 444 010 015</b>
				D 2066 LF43 <Euro 5/OBD2>; D 2066 LF60 <Euro 5/EEV/OBD2>	09.09→				<b>0 444 010 026</b>
<b>26.360</b>		10,5	265	D 2066 LF19 <Euro 5/OBD1>; D 2066 LF27 <Euro 5/OBD1>	10.07→		TW		<b>0 444 010 013</b>
									<b>0 444 010 015</b>
	, WW	10,5	265	D 2066 LF42 <Euro 5/OBD2>; D 2066 LF59 <Euro 5/EEV/OBD2>; D 2066 LF64 <Euro 4/OBD2>	09.09→				<b>0 444 010 026</b>
<b>26.400</b>		10,5	294	D 2066 LF18 <Euro 5/OBD1>; D 2066 LF26 <Euro 5/OBD1>	10.07→		TW		<b>0 444 010 013</b>
									<b>0 444 010 015</b>
	, WW	10,5	294	D 2066 LF41 <Euro 5/OBD2>; D 2066 LF58 <Euro 5/EEV/OBD2>; D 2066 LF63 <Euro 4/OBD2>	09.09→				<b>0 444 010 026</b>
<b>26.440</b>		10,5	324	D 2066 LF17 <Euro 5/OBD1>; D 2066 LF25 <Euro 5/OBD1>	10.07→		TW		<b>0 444 010 013</b>
									<b>0 444 010 015</b>
	, WW	10,5	324	D 2066 LF40 <Euro 5/OBD2>; D 2066 LF57 <Euro 5/EEV/OBD2>; D 2066 LF62 <Euro 4/OBD2>	09.09→				<b>0 444 010 026</b>
<b>26.480</b>		12,4	353	D 2676 LF07 <Euro 5/OBD2>	09.09→				<b>0 444 010 026</b>
				D 2676 LF14 <Euro 5/OBD1>; D 2676 LF16 <Euro 5/OBD1>	10.07→		TW		<b>0 444 010 013</b>
									<b>0 444 010 015</b>
				D 2676 LF18 <Euro 5/EEV/OBD2>	09.09→				<b>0 444 010 026</b>
	WW	12,4	353	D 2676 LF20 <Euro 4/OBD2>	02.11→				<b>0 444 010 015</b>
<b>26.540</b>		12,4	397	D 2676 LF06 <Euro 5/OBD2>	09.09→				<b>0 444 010 026</b>
				D 2676 LF13 <Euro 5/OBD1>; D 2676 LF15 <Euro 5/OBD1>	10.07→		TW		<b>0 444 010 013</b>
									<b>0 444 010 015</b>
<b>28.320</b>		10,5	235	D 2066 LF43 <Euro 5/OBD2>; D 2066 LF60 <Euro 5/EEV/OBD2>	09.09→				<b>0 444 010 026</b>
			236	D 2066 LF20 <Euro 5/OBD1>; D 2066 LF28 <Euro 5/OBD1>	09.07→		TW		<b>0 444 010 013</b>
									<b>0 444 010 015</b>













◀ MAN

<b>28.360</b>	10,5	265	D 2066 LF19 <Euro 5/OBD1>; D 2066 LF27 <Euro 5/OBD1>	09.07→	TW	<b>0 444 010 013</b> <b>0 444 010 015</b>
, WW	10,5	265	D 2066 LF42 <Euro 5/OBD2>; D 2066 LF59 <Euro 5/EEV/OBD2>; D 2066 LF64 <Euro 4/OBD2>	09.09→		<b>0 444 010 026</b>
<b>28.400</b>	10,5	294	D 2066 LF18 <Euro 5/OBD1>; D 2066 LF26 <Euro 5/OBD1>	09.07→	TW	<b>0 444 010 013</b> <b>0 444 010 015</b>
, WW	10,5	294	D 2066 LF41 <Euro 5/OBD2>; D 2066 LF58 <Euro 5/EEV/OBD2>; D 2066 LF63 <Euro 4/OBD2>	09.09→		<b>0 444 010 026</b>
<b>28.440</b>	10,5	324	D 2066 LF17 <Euro 5/OBD1>; D 2066 LF25 <Euro 5/OBD1>	09.07→	TW	<b>0 444 010 013</b> <b>0 444 010 015</b>
, WW	10,5	324	D 2066 LF40 <Euro 5/OBD2>; D 2066 LF57 <Euro 5/EEV/OBD2>; D 2066 LF62 <Euro 4/OBD2>	09.09→		<b>0 444 010 026</b>
<b>28.480</b>	12,4	353	D 2676 LF07 <Euro 5/OBD2>	09.09→		<b>0 444 010 026</b>
			D 2676 LF14 <Euro 5/OBD1>; D 2676 LF16 <Euro 5/OBD1>	09.07→	TW	<b>0 444 010 013</b> <b>0 444 010 015</b>
			D 2676 LF18 <Euro 5/EEV/OBD2>	09.09→		<b>0 444 010 026</b>
WW	12,4	353	D 2676 LF20 <Euro 4/OBD2>	02.11→		<b>0 444 010 015</b>
<b>28.540</b>	12,4	397	D 2676 LF06 <Euro 5/OBD2>	09.09→		<b>0 444 010 026</b>
			D 2676 LF13 <Euro 5/OBD1>; D 2676 LF15 <Euro 5/OBD1>	09.07→	TW	<b>0 444 010 013</b> <b>0 444 010 015</b>
<b>32.320</b>	10,5	235	D 2066 LF20 <Euro 5/OBD1>; D 2066 LF28 <Euro 5/OBD1>	10.07→	TW	<b>0 444 010 013</b> <b>0 444 010 015</b>
			D 2066 LF43 <Euro 5/OBD2>; D 2066 LF60 <Euro 5/EEV/OBD2>	09.09→		<b>0 444 010 026</b>
<b>32.360</b>	10,5	265	D 2066 LF19 <Euro 5/OBD1>; D 2066 LF27 <Euro 5/OBD1>	10.07→	TW	<b>0 444 010 013</b> <b>0 444 010 015</b>
			D 2066 LF42 <Euro 5/OBD2>; D 2066 LF59 <Euro 5/EEV/OBD2>	09.09→		<b>0 444 010 026</b>
<b>32.400</b>	10,5	294	D 2066 LF18 <Euro 5/OBD1>; D 2066 LF26 <Euro 5/OBD1>	10.07→	TW	<b>0 444 010 013</b> <b>0 444 010 015</b>
			D 2066 LF41 <Euro 5/OBD2>; D 2066 LF58 <Euro 5/EEV/OBD2>	09.09→		<b>0 444 010 026</b>
<b>32.440</b>	10,5	324	D 2066 LF17 <Euro 5/OBD1>; D 2066 LF25 <Euro 5/OBD1>	10.07→	TW	<b>0 444 010 013</b> <b>0 444 010 015</b>
			D 2066 LF40 <Euro 5/OBD2>; D 2066 LF57 <Euro 5/EEV/OBD2>	09.09→		<b>0 444 010 026</b>
<b>32.480</b>	12,4	353	D 2676 LF07 <Euro 5/OBD2>	09.09→		<b>0 444 010 026</b>
			D 2676 LF14 <Euro 5/OBD1>; D 2676 LF16 <Euro 5/OBD1>	10.07→	TW	<b>0 444 010 013</b> <b>0 444 010 015</b>
			D 2676 LF18 <Euro 5/EEV/OBD2>	09.09→		<b>0 444 010 026</b>
<b>33.320</b>	10,5	235	D 2066 LF20 <Euro 5/OBD1>; D 2066 LF28 <Euro 5/OBD1>	10.07→	TW	<b>0 444 010 013</b> <b>0 444 010 015</b>
			D 2066 LF43 <Euro 5/OBD2>; D 2066 LF60 <Euro 5/EEV/OBD2>	09.09→		<b>0 444 010 026</b>
<b>33.360</b>	10,5	265	D 2066 LF19 <Euro 5/OBD1>; D 2066 LF27 <Euro 5/OBD1>	10.07→	TW	<b>0 444 010 013</b> <b>0 444 010 015</b>
, WW	10,5	265	D 2066 LF42 <Euro 5/OBD2>; D 2066 LF59 <Euro 5/EEV/OBD2>; D 2066 LF64 <Euro 4/OBD2>	09.09→		<b>0 444 010 026</b>
<b>33.400</b>	10,5	294	D 2066 LF18 <Euro 5/OBD1>; D 2066 LF26 <Euro 5/OBD1>	10.07→	TW	<b>0 444 010 013</b> <b>0 444 010 015</b>
, WW	10,5	294	D 2066 LF41 <Euro 5/OBD2>; D 2066 LF58 <Euro 5/EEV/OBD2>; D 2066 LF63 <Euro 4/OBD2>	09.09→		<b>0 444 010 026</b>
<b>33.440</b>	10,5	324	D 2066 LF17 <Euro 5/OBD1>; D 2066 LF25 <Euro 5/OBD1>	10.07→	TW	<b>0 444 010 013</b> <b>0 444 010 015</b>
, WW	10,5	324	D 2066 LF40 <Euro 5/OBD2>; D 2066 LF57 <Euro 5/EEV/OBD2>; D 2066 LF62 <Euro 4/OBD2>	09.09→		<b>0 444 010 026</b>
<b>33.480</b>	12,4	353	D 2676 LF07 <Euro 5/OBD2>	09.09→		<b>0 444 010 026</b>
			D 2676 LF18 <Euro 5/EEV/OBD2>	09.09→		<b>0 444 010 026</b>
, DF	12,4	353	D 2676 LF14 <Euro 5/OBD1>; D 2676 LF16 <Euro 5/OBD1>	10.07→	TW	<b>0 444 010 013</b> <b>0 444 010 015</b>
WW	12,4	353	D 2676 LF20 <Euro 4/OBD2>	02.11→		<b>0 444 010 015</b>
<b>33.540</b>	12,4	397	D 2676 LF06 <Euro 5/OBD2>	09.09→		<b>0 444 010 026</b>



									
	l/ccm		kW/(PS)	Typ					
<b>33.540</b>	12,4	397		D 2676 LF13 <Euro 5/OBD1>; D 2676 LF15 <Euro 5/OBD1>	10.07→		TW	<b>0 444 010 013</b>	
								<b>0 444 010 015</b>	
<b>35.320</b>	10,5	235		D 2066 LF20 <Euro 5/OBD1>; D 2066 LF28 <Euro 5/OBD1>	10.07→		TW	<b>0 444 010 013</b>	
								<b>0 444 010 015</b>	
				D 2066 LF43 <Euro 5/OBD2>; D 2066 LF60 <Euro 5/EEV/OBD2>	09.09→			<b>0 444 010 026</b>	
<b>35.360</b>	10,5	265		D 2066 LF19 <Euro 5/OBD1>; D 2066 LF27 <Euro 5/OBD1>	10.07→		TW	<b>0 444 010 013</b>	
								<b>0 444 010 015</b>	
, WW	10,5	265		D 2066 LF42 <Euro 5/OBD2>; D 2066 LF59 <Euro 5/EEV/OBD2>; D 2066 LF64 <Euro 4/OBD2>	09.09→			<b>0 444 010 026</b>	
<b>35.400</b>	10,5	294		D 2066 LF18 <Euro 5/OBD1>; D 2066 LF26 <Euro 5/OBD1>	10.07→		TW	<b>0 444 010 013</b>	
								<b>0 444 010 015</b>	
, WW	10,5	294		D 2066 LF41 <Euro 5/OBD2>; D 2066 LF58 <Euro 5/EEV/OBD2>; D 2066 LF63 <Euro 4/OBD2>	09.09→			<b>0 444 010 026</b>	
<b>35.440</b>	10,5	324		D 2066 LF17 <Euro 5/OBD1>; D 2066 LF25 <Euro 5/OBD1>	10.07→		TW	<b>0 444 010 013</b>	
								<b>0 444 010 015</b>	
, WW	10,5	324		D 2066 LF40 <Euro 5/OBD2>; D 2066 LF57 <Euro 5/EEV/OBD2>; D 2066 LF62 <Euro 4/OBD2>	09.09→			<b>0 444 010 026</b>	
<b>35.480</b>	12,4	353		D 2676 LF07 <Euro 5/OBD2>	09.09→			<b>0 444 010 026</b>	
				D 2676 LF14 <Euro 5/OBD1>; D 2676 LF16 <Euro 5/OBD1>	10.07→		TW	<b>0 444 010 013</b>	
								<b>0 444 010 015</b>	
				D 2676 LF18 <Euro 5/EEV/OBD2>	09.09→			<b>0 444 010 026</b>	
WW	12,4	353		D 2676 LF20 <Euro 4/OBD2>	02.11→			<b>0 444 010 015</b>	
<b>35.540</b>	12,4	397		D 2676 LF06 <Euro 5/OBD2>	09.09→			<b>0 444 010 026</b>	
				D 2676 LF13 <Euro 5/OBD1>; D 2676 LF15 <Euro 5/OBD1>	10.07→		TW	<b>0 444 010 013</b>	
								<b>0 444 010 015</b>	
<b>37.320</b>	10,5	235		D 2066 LF20 <Euro 5/OBD1>; D 2066 LF28 <Euro 5/OBD1>	10.07→		TW	<b>0 444 010 013</b>	
								<b>0 444 010 015</b>	
				D 2066 LF43 <Euro 5/OBD2>; D 2066 LF60 <Euro 5/EEV/OBD2>	09.09→			<b>0 444 010 026</b>	
<b>37.360</b>	10,5	265		D 2066 LF19 <Euro 5/OBD1>; D 2066 LF27 <Euro 5/OBD1>	10.07→		TW	<b>0 444 010 013</b>	
								<b>0 444 010 015</b>	
				D 2066 LF42 <Euro 5/OBD2>; D 2066 LF59 <Euro 5/EEV/OBD2>	09.09→			<b>0 444 010 026</b>	
<b>37.400</b>	10,5	294		D 2066 LF26 <Euro 5/OBD1>	10.07→		TW	<b>0 444 010 013</b>	
								<b>0 444 010 015</b>	
				D 2066 LF41 <Euro 5/OBD2>; D 2066 LF58 <Euro 5/EEV/OBD2>	09.09→			<b>0 444 010 026</b>	
<b>37.440</b>	10,5	324		D 2066 LF17 <Euro 5/OBD1>; D 2066 LF25 <Euro 5/OBD1>	10.07→		TW	<b>0 444 010 013</b>	
								<b>0 444 010 015</b>	
				D 2066 LF40 <Euro 5/OBD2>; D 2066 LF57 <Euro 5/EEV/OBD2>	09.09→			<b>0 444 010 026</b>	
<b>37.480</b>	12,4	353		D 2676 LF07 <Euro 5/OBD2>	09.09→			<b>0 444 010 026</b>	
				D 2676 LF14 <Euro 5/OBD1>; D 2676 LF16 <Euro 5/OBD1>	10.07→		TW	<b>0 444 010 013</b>	
								<b>0 444 010 015</b>	
				D 2676 LF18 <Euro 5/EEV/OBD2>	09.09→			<b>0 444 010 026</b>	
<b>37.540</b>	12,4	397		D 2676 LF06 <Euro 5/OBD2>	09.09→			<b>0 444 010 026</b>	
				D 2676 LF13 <Euro 5/OBD1>; D 2676 LF15 <Euro 5/OBD1>	10.07→		TW	<b>0 444 010 013</b>	
								<b>0 444 010 015</b>	
<b>40.360 WW</b>	10,5	265		D 2066 LF64 <Euro 4/OBD2>	12.11→			<b>0 444 010 026</b>	
<b>40.400 WW</b>	10,5	294		D 2066 LF63 <Euro 4/OBD2>	12.11→			<b>0 444 010 026</b>	
<b>40.440 WW</b>	10,5	324		D 2066 LF62 <Euro 4/OBD2>	12.11→			<b>0 444 010 026</b>	
<b>40.480 WW</b>	12,4	353		D 2676 LF20 <Euro 4/OBD2>	12.11→			<b>0 444 010 015</b>	
<b>41.320</b>	10,5	235		D 2066 LF20 <Euro 5/OBD1>; D 2066 LF28 <Euro 5/OBD1>	10.07→		TW	<b>0 444 010 013</b>	
								<b>0 444 010 015</b>	
				D 2066 LF43 <Euro 5/OBD2>; D 2066 LF60 <Euro 5/EEV/OBD2>	09.09→			<b>0 444 010 026</b>	
<b>41.360</b>	10,5	265		D 2066 LF19 <Euro 5/OBD1>; D 2066 LF27 <Euro 5/OBD1>	10.07→		TW	<b>0 444 010 013</b>	
								<b>0 444 010 015</b>	
, WW	10,5	265		D 2066 LF42 <Euro 5/OBD2>; D 2066 LF59 <Euro 5/EEV/OBD2>; D 2066 LF64 <Euro 4/OBD2>	09.09→			<b>0 444 010 026</b>	
<b>41.400</b>	10,5	294		D 2066 LF18 <Euro 5/OBD1>; D 2066 LF26 <Euro 5/OBD1>	10.07→		TW	<b>0 444 010 013</b>	
								<b>0 444 010 015</b>	













◀ MAN

<b>41.400</b> , WW	10,5	294	D 2066 LF41 <Euro 5/OBD2>; D 2066 LF58 <Euro 5/EEV/OBD2>; D 2066 LF63 <Euro 4/OBD2>	09.09→		<b>0 444 010 026</b>
<b>41.440</b>	10,5	324	D 2066 LF17 <Euro 5/OBD1>; D 2066 LF25 <Euro 5/OBD1>	10.07→	TW	<b>0 444 010 013</b> <b>0 444 010 015</b>
, WW	10,5	324	D 2066 LF40 <Euro 5/OBD2>; D 2066 LF57 <Euro 5/EEV/OBD2>; D 2066 LF62 <Euro 4/OBD2>	09.09→		<b>0 444 010 026</b>
<b>41.480</b>	12,4	353	D 2676 LF07 <Euro 5/OBD2>	09.09→		<b>0 444 010 026</b>
			D 2676 LF14 <Euro 5/OBD1>; D 2676 LF16 <Euro 5/OBD1>	10.07→	TW	<b>0 444 010 013</b> <b>0 444 010 015</b>
			D 2676 LF18 <Euro 5/EEV/OBD2>	09.09→		<b>0 444 010 026</b>
WW	12,4	353	D 2676 LF20 <Euro 4/OBD2>	02.11→		<b>0 444 010 015</b>
<b>41.540</b>	12,4	397	D 2676 LF06 <Euro 5/OBD2>	09.09→		<b>0 444 010 026</b>
			D 2676 LF13 <Euro 5/OBD1>; D 2676 LF15 <Euro 5/OBD1>	10.07→	TW	<b>0 444 010 013</b> <b>0 444 010 015</b>
<b>TGX</b>						
<b>18.360</b>	10,5	265	D 2066 LF19 <Euro 5/OBD1>; D 2066 LF27 <Euro 5/OBD1>	10.07→	TW	<b>0 444 010 013</b> <b>0 444 010 015</b>
			D 2066 LF42 <Euro 5/OBD2>; D 2066 LF59 <Euro 5/EEV/OBD2>	09.09→		<b>0 444 010 026</b>
<b>18.400</b>	10,5	294	D 2066 LF18 <Euro 5/OBD1>; D 2066 LF26 <Euro 5/OBD1>	10.07→	TW	<b>0 444 010 013</b> <b>0 444 010 015</b>
			D 2066 LF41 <Euro 5/OBD2>; D 2066 LF58 <Euro 5/EEV/OBD2>	09.09→		<b>0 444 010 026</b>
<b>18.440</b>	10,5	324	D 2066 LF17 <Euro 5/OBD1>; D 2066 LF25 <Euro 5/OBD1>	10.07→	TW	<b>0 444 010 013</b> <b>0 444 010 015</b>
			D 2066 LF40 <Euro 5/OBD2>; D 2066 LF57 <Euro 5/EEV/OBD2>	09.09→		<b>0 444 010 026</b>
<b>18.480</b>	12,4	353	D 2676 LF07 <Euro 5/OBD2>	09.09→		<b>0 444 010 026</b>
			D 2676 LF18 <Euro 5/EEV/OBD2>	09.09→		<b>0 444 010 026</b>
, F, FL	12,4	353	D 2676 LF14 <Euro 5/OBD1>; D 2676 LF16 <Euro 5/OBD1>	10.07→	TW	<b>0 444 010 013</b> <b>0 444 010 015</b>
<b>18.540</b>	12,4	397	D 2676 LF06 <Euro 5/OBD2>	09.09→		<b>0 444 010 026</b>
			D 2676 LF13 <Euro 5/OBD1>; D 2676 LF15 <Euro 5/OBD1>	10.07→	TW	<b>0 444 010 013</b> <b>0 444 010 015</b>
<b>18.680</b>	16,2	500	D 2868 LF02 <Euro 5/OBD1>	01.08→		<b>0 444 010 015</b>
			D 2868 LF05 <Euro 5/EEV/OBD2>	09.09→		<b>0 444 010 026</b>
<b>24.360</b>	10,5	265	D 2066 LF19 <Euro 5/OBD1>; D 2066 LF27 <Euro 5/OBD1>	10.07→	TW	<b>0 444 010 013</b> <b>0 444 010 015</b>
			D 2066 LF42 <Euro 5/OBD2>; D 2066 LF59 <Euro 5/EEV/OBD2>	09.09→		<b>0 444 010 026</b>
<b>24.400</b>	10,5	294	D 2066 LF18 <Euro 5/OBD1>; D 2066 LF26 <Euro 5/OBD1>	10.07→	TW	<b>0 444 010 013</b> <b>0 444 010 015</b>
			D 2066 LF41 <Euro 5/OBD2>; D 2066 LF58 <Euro 5/EEV/OBD2>	09.09→		<b>0 444 010 026</b>
<b>24.440</b>	10,5	324	D 2066 LF17 <Euro 5/OBD1>; D 2066 LF25 <Euro 5/OBD1>	10.07→	TW	<b>0 444 010 013</b> <b>0 444 010 015</b>
			D 2066 LF40 <Euro 5/OBD2>; D 2066 LF57 <Euro 5/EEV/OBD2>	09.09→		<b>0 444 010 026</b>
<b>24.480</b>	12,4	353	D 2676 LF07 <Euro 5/OBD2>	09.09→		<b>0 444 010 026</b>
			D 2676 LF14 <Euro 5/OBD1>; D 2676 LF16 <Euro 5/OBD1>	10.07→	TW	<b>0 444 010 013</b> <b>0 444 010 015</b>
			D 2676 LF18 <Euro 5/EEV/OBD2>	09.09→		<b>0 444 010 026</b>
<b>24.540</b>	12,4	397	D 2676 LF06 <Euro 5/OBD2>	09.09→		<b>0 444 010 026</b>
<b>26.360</b>	10,5	265	D 2066 LF19 <Euro 5/OBD1>; D 2066 LF27 <Euro 5/OBD1>	10.07→	TW	<b>0 444 010 013</b> <b>0 444 010 015</b>
			D 2066 LF42 <Euro 5/OBD2>; D 2066 LF59 <Euro 5/EEV/OBD2>	09.09→		<b>0 444 010 026</b>
<b>26.400</b>	10,5	294	D 2066 LF18 <Euro 5/OBD1>; D 2066 LF26 <Euro 5/OBD1>	10.07→	TW	<b>0 444 010 013</b> <b>0 444 010 015</b>
			D 2066 LF41 <Euro 5/OBD2>; D 2066 LF58 <Euro 5/EEV/OBD2>	09.09→		<b>0 444 010 026</b>





									
26.440	10,5	324	D 2066 LF17 <Euro 5/OBD1>; D 2066 LF25	10.07→	TW			<b>0 444 010 013</b>	
			<Euro 5/OBD1>				<b>0 444 010 015</b>		
26.480	12,4	353	D 2066 LF40 <Euro 5/OBD2>; D 2066 LF57	09.09→				<b>0 444 010 026</b>	
			<Euro 5/EEV/OBD2>						
26.480	12,4	353	D 2676 LF07 <Euro 5/OBD2>	09.09→				<b>0 444 010 026</b>	
			D 2676 LF14 <Euro 5/OBD1>; D 2676 LF16	10.07→	TW		<b>0 444 010 013</b>		
			<Euro 5/OBD1>				<b>0 444 010 015</b>		
26.540	12,4	397	D 2676 LF18 <Euro 5/EEV/OBD2>	09.09→				<b>0 444 010 026</b>	
			D 2676 LF06 <Euro 5/OBD2>	09.09→			<b>0 444 010 026</b>		
			D 2676 LF13 <Euro 5/OBD1>; D 2676 LF15	10.07→	TW		<b>0 444 010 013</b>		
28.360	10,5	265	<Euro 5/OBD1>					<b>0 444 010 015</b>	
			D 2066 LF19 <Euro 5/OBD1>; D 2066 LF27	10.07→	TW		<b>0 444 010 013</b>		
			<Euro 5/OBD1>				<b>0 444 010 015</b>		
28.400	10,5	294	D 2066 LF42 <Euro 5/OBD2>; D 2066 LF59	09.09→				<b>0 444 010 026</b>	
			<Euro 5/EEV/OBD2>						
			D 2066 LF18 <Euro 5/OBD1>; D 2066 LF26	10.07→	TW		<b>0 444 010 013</b>		
28.440	10,5	324	<Euro 5/OBD1>					<b>0 444 010 015</b>	
			D 2066 LF41 <Euro 5/OBD2>; D 2066 LF58	09.09→			<b>0 444 010 026</b>		
			<Euro 5/EEV/OBD2>						
28.440	10,5	324	D 2066 LF17 <Euro 5/OBD1>; D 2066 LF25	10.07→	TW			<b>0 444 010 013</b>	
			<Euro 5/OBD1>				<b>0 444 010 015</b>		
			D 2066 LF40 <Euro 5/OBD2>; D 2066 LF57	09.09→			<b>0 444 010 026</b>		
28.480	12,4	353	<Euro 5/EEV/OBD2>					<b>0 444 010 026</b>	
			D 2676 LF07 <Euro 5/OBD2>	09.09→			<b>0 444 010 026</b>		
			D 2676 LF14 <Euro 5/OBD1>	10.07→	TW		<b>0 444 010 013</b>		
28.540	12,4	397	<Euro 5/OBD1>					<b>0 444 010 015</b>	
			D 2676 LF18 <Euro 5/EEV/OBD2>	09.09→			<b>0 444 010 026</b>		
			D 2676 LF06 <Euro 5/OBD2>	09.09→			<b>0 444 010 026</b>		
33.360	10,5	265	D 2676 LF13 <Euro 5/OBD1>; D 2676 LF15	10.07→	TW			<b>0 444 010 013</b>	
			<Euro 5/OBD1>				<b>0 444 010 015</b>		
			D 2066 LF19 <Euro 5/OBD1>; D 2066 LF27	10.07→	TW		<b>0 444 010 013</b>		
33.400	10,5	294	<Euro 5/OBD1>					<b>0 444 010 015</b>	
			D 2066 LF42 <Euro 5/OBD2>; D 2066 LF59	09.09→			<b>0 444 010 026</b>		
			<Euro 5/EEV/OBD2>						
33.440	10,5	324	D 2066 LF18 <Euro 5/OBD1>; D 2066 LF26	10.07→	TW			<b>0 444 010 013</b>	
			<Euro 5/OBD1>				<b>0 444 010 015</b>		
			D 2066 LF41 <Euro 5/OBD2>; D 2066 LF58	09.09→			<b>0 444 010 026</b>		
33.440	10,5	324	<Euro 5/EEV/OBD2>					<b>0 444 010 026</b>	
			D 2066 LF17 <Euro 5/OBD1>; D 2066 LF25	10.07→	TW		<b>0 444 010 013</b>		
			<Euro 5/OBD1>				<b>0 444 010 015</b>		
33.480	12,4	353	D 2066 LF40 <Euro 5/OBD2>; D 2066 LF57	09.09→				<b>0 444 010 026</b>	
			<Euro 5/EEV/OBD2>						
			D 2676 LF07 <Euro 5/OBD2>	09.09→			<b>0 444 010 026</b>		
33.540	12,4	397	D 2676 LF18 <Euro 5/EEV/OBD2>	09.09→				<b>0 444 010 026</b>	
			D 2676 LF14 <Euro 5/OBD1>; D 2676 LF16	10.07→	TW		<b>0 444 010 013</b>		
			<Euro 5/OBD1>				<b>0 444 010 015</b>		
33.680	12,4	397	D 2676 LF06 <Euro 5/OBD2>	09.09→				<b>0 444 010 026</b>	
			D 2676 LF13 <Euro 5/OBD1>; D 2676 LF15	10.07→	TW		<b>0 444 010 013</b>		
			<Euro 5/OBD1>				<b>0 444 010 015</b>		
35.360	16,2	500	D 2868 LF02 <Euro 5/OBD1>	01.08→				<b>0 444 010 015</b>	
			D 2868 LF05 <Euro 5/EEV/OBD2>	09.09→			<b>0 444 010 026</b>		
			D 2066 LF19 <Euro 5/OBD1>; D 2066 LF27	09.07→	TW		<b>0 444 010 013</b>		
35.400	10,5	265	<Euro 5/OBD1>					<b>0 444 010 015</b>	
			D 2066 LF42 <Euro 5/OBD2>; D 2066 LF59	09.09→			<b>0 444 010 026</b>		
			<Euro 5/EEV/OBD2>						
35.400	10,5	294	D 2066 LF18 <Euro 5/OBD1>; D 2066 LF26	09.07→	TW			<b>0 444 010 013</b>	
			<Euro 5/OBD1>				<b>0 444 010 015</b>		
			D 2066 LF41 <Euro 5/OBD2>; D 2066 LF58	09.09→			<b>0 444 010 026</b>		
35.440	10,5	324	<Euro 5/EEV/OBD2>					<b>0 444 010 026</b>	
			D 2066 LF17 <Euro 5/OBD1>; D 2066 LF25	09.07→	TW		<b>0 444 010 013</b>		
			<Euro 5/OBD1>				<b>0 444 010 015</b>		
35.440	10,5	324	D 2066 LF40 <Euro 5/OBD2>; D 2066 LF57	09.09→				<b>0 444 010 026</b>	
			<Euro 5/EEV/OBD2>						
			<Euro 5/EEV/OBD2>						





◀ MAN

35.480	12,4	353	D 2676 LF07 <Euro 5/OBD2>	09.09→		0 444 010 026
			D 2676 LF14 <Euro 5/OBD1>; D 2676 LF16 <Euro 5/OBD1>	09.07→	TW	0 444 010 013
			D 2676 LF18 <Euro 5/EEV/OBD2>	09.09→		0 444 010 026
35.540	12,4	397	D 2676 LF06 <Euro 5/OBD2>	09.09→		0 444 010 026
			D 2676 LF13 <Euro 5/OBD1>; D 2676 LF15 <Euro 5/OBD1>	09.07→	TW	0 444 010 013
			D 2676 LF18 <Euro 5/EEV/OBD2>	09.09→		0 444 010 026
41.540	12,4	397	D 2676 LF06 <Euro 5/OBD2>	09.09→		0 444 010 026
			D 2676 LF13 <Euro 5/OBD1>; D 2676 LF15 <Euro 5/OBD1>	10.07→	TW	0 444 010 013
			D 2676 LF18 <Euro 5/EEV/OBD2>	09.09→		0 444 010 026
41.680	16,2	500	D 2868 LF03 <Euro 5/OBD1>	01.08→		0 444 010 015
			D 2868 LF06 <Euro 5/OBD2>	09.09→		0 444 010 026

**RENAULT**

<b>Kerax</b>						
370	10,8	272	DXi 11 370 <Euro 4>; DXi 11 370 <Euro 5>	05.06-08.08		0 986 44D 102 0 986 44D 103
410	10,8	302	DXi 11 410 <Euro 4>; DXi 11 410 <Euro 5>	05.06-08.08		0 986 44D 102 0 986 44D 103
450	10,8	331	DXi 11 450 <Euro 4>; DXi 11 450 <Euro 5>	05.06-08.08		0 986 44D 102 0 986 44D 103
460	12,8	339	DXi 13 460 <Euro 4>	03.08-08.08		0 986 44D 102 0 986 44D 103
500	12,8	369	DXi 13 500 <Euro 4>	03.08-08.08		0 986 44D 102 0 986 44D 103
<b>Magnum</b>						
460 E. TECH	12,8	339	DXi 13 460 <2001/72B1, Euro 4>; DXi 13 460 <2001/72B2, Euro 5>	05.06-08.08		0 986 44D 102 0 986 44D 103
500 E. TECH, E.TECH	12,8	368	DXi 13 500 <2001/72B1, Euro 4>; DXi 13 500 <2001/72B2, Euro 5>	05.06-08.08		0 986 44D 102 0 986 44D 103
<b>Midlum II</b>						
160	4,8	118	DXi 5 160 <Euro 3/4>	05.06-08.08		0 986 44D 102 0 986 44D 103
190	4,8	140	DXi 5 190 <Euro 3/4>	05.06-08.08		0 986 44D 102 0 986 44D 103
220	4,8	158	DXi 5 220 <Euro 3/4>	05.06-08.08		0 986 44D 102 0 986 44D 103
			DXi 5 220 <Euro 5>	03.07-08.08		0 986 44D 102 0 986 44D 103
240	7,2	177	DXi 7 240 <Euro 3/4>	05.06-08.08		0 986 44D 102 0 986 44D 103
280	7,2	206	DXi 7 280 <Euro 3/4>	05.06-08.08		0 986 44D 102 0 986 44D 103
			DXi 7 280 <Euro 5>	03.07-08.08		0 986 44D 102 0 986 44D 103
<b>Premium II</b>						
240 Distribution	7,2	177	DXi 7 240 <122CX, Euro 4>	06.06-08.08		0 986 44D 102 0 986 44D 103
280 Distribution, Lander	7,2	206	DXi 7 280 <Euro 5>; DXi 7 280 <122CW, Euro 4>	06.06-08.08		0 986 44D 102 0 986 44D 103
320 Distribution, Lander	7,2	235	DXi 7 320 <Euro 5>; DXi 7 320 <122CY, Euro 4>	05.06-08.08		0 986 44D 102 0 986 44D 103
370 Distribution, Lander, Route	10,8	272	DXi 11 370 <Euro 5>; DXi 11 370 <2001/72B1 Euro 4>; DXi 11 370 <2001/72B2 Euro 5>	05.06-08.08		0 986 44D 102 0 986 44D 103
410 Distribution, Lander, Route	10,8	302	DXi 11 410 <2001/72B1 Euro 4>; DXi 11 410 <2001/72B2 Euro 5>	05.06-08.08		0 986 44D 102 0 986 44D 103
450 Distribution, Lander, Route	10,8	331	DXi 11 450 <Euro 5>; DXi 11 450 <2001/72B1 Euro 4>; DXi 11 450 <2001/72B2 Euro 5>	05.06-08.08		0 986 44D 102 0 986 44D 103





## SCANIA

G						
420	12,0	309	DC 12.15 <Euro 5>		09.07→	0 444 010 032
P						
420	12,0	309	DC 12.15 <Euro 5>		02.06→	0 444 010 032
R						
420	11,7	309	DC 12.22 <Euro 5/EEV>		09.07→	0 444 010 032
	12,0	309	DC 12.15 <Euro 5>		02.06→	0 444 010 032
500	16,0	368	DC 16.06 <Euro 4>; DC 16.19 <Euro 5>		02.06→	0 444 010 032
560	16,0	412	DC 16.05 <Euro 4>; DC 16.18 <Euro 5>		02.06→	0 444 010 032
620	16,0	456	DC 16.08 <Euro 4>; DC 16.17 <Euro 5>		02.06→	0 444 010 032

## VOLVO

B						
12 B	12,0	250/279/ 309/338	DH12E340; DH12E380; DH12E420; DH12E460		01.05→ TW	0 444 022 034 0 986 44D 103
FE						
240	7,1	177	D7E240; D7F240		05.06→	0 444 022 034
260	7,1	191	D7F260		05.09→	0 444 022 034
280	7,1	206	D7E280		05.06→	0 444 022 034
300	7,1	221	D7F300		05.09→	0 444 022 034
320	7,1	235	D7E320		05.06→	0 444 022 034
340	7,1	250	D7F340		05.09→	0 444 022 034
FH						
16 540, 550, 580, 600, 610, 660, 700	16,0	397/404/ 426/442/ 449/485/ 515	D16C550; D16C610; D16E540; D16E580; D16E660; D16G540; D16G600; D16G700		01.03→ TW	0 444 022 034
380	12,8	280	D13C380		01.09→ TW	0 444 022 034
400	12,8	294	D13A400; D13B400		09.06→ TW	0 444 022 034
420	12,8	309	D13C420		01.09→ TW	0 444 022 034
440	12,8	324	D13A440; D13B440		09.06→ TW	0 444 022 034
460	12,8	339	D13C460		01.09→ TW	0 444 022 034
480	12,8	353	D13A480		09.06→ TW	0 444 022 034
500	12,8	368	D13B500; D13C500		09.07→ TW	0 444 022 034
520	12,8	382	D13A520		09.06→ TW	0 444 022 034
540	12,8	397	D13C540		01.09→ TW	0 444 022 034
FL						
240	7,1	177	D7E240; D7F240		05.06→	0 444 022 034
260	7,1	191	D7F260		04.09→	0 444 022 034
280	7,1	206	D7E280		05.06→	0 444 022 034
290	7,1	213	D7F290		04.09→	0 444 022 034
320	7,1	236	D7E320		05.06→	0 444 022 034
FM						
330	10,8	243	D11C330		05.09→	0 444 022 034
350	10,8	258	D11B350		06.08→	0 444 022 034
360	12,8	265	D13A360; D13B360		09.05→ TW	0 444 022 034 0 986 44D 103
370	10,8	272	D11C370		05.09→	0 444 022 034
380	12,8	280	D13C380		05.09→ TW	0 444 022 034 0 986 44D 103
390	10,8	287	D11B390		06.08→	0 444 022 034
400	12,8	294	D13A400; D13B400		09.05→ TW	0 444 022 034 0 986 44D 103
410	10,8	302	D11C410		05.09→	0 444 022 034
420	12,8	309	D13C420		05.09→ TW	0 444 022 034 0 986 44D 103
430	10,8	316	D11B430		06.08→	0 444 022 034
440	12,8	324	D13A440; D13B440		09.05→ TW	0 444 022 034 0 986 44D 103
450	10,8	331	D11C450		05.09→	0 444 022 034
460	12,8	339	D13C460		05.09→ TW	0 444 022 034 0 986 44D 103
480	12,8	353	D13A480		09.05→ TW	0 444 022 034 0 986 44D 103
500	12,8	368	D13C500		05.09→ TW	0 444 022 034 0 986 44D 103



**VW (VOLKSWAGEN)****Crafter 30**

2.5 TDI [2E, 2F]	2,5	65/80/ 100/120	CEBA <D5K>; CEBB <D5L>; CECA <D5M>; CECB <D5N>	05.09→	<b>F 01C 600 105</b>
------------------	-----	-------------------	---	--------	----------------------

**Crafter 35**

2.5 TDI [2E, 2F]	2,5	65/80/ 100/120	CEBA <D5K>; CEBB <D5L>; CECA <D5M>; CECB <D5N>	05.09→	<b>F 01C 600 105</b>
------------------	-----	-------------------	---	--------	----------------------

**Crafter 50**

2.5 TDI [2E, 2F]	2,5	80/100/ 120	CEBB <D5L>; CECA <D5M>; CECE <D5N>	05.09→	<b>F 01C 600 105</b>
------------------	-----	----------------	------------------------------------	--------	----------------------









## ◀ BOSCH-EXCHANGE

KBEL 117 P74	<b>0 986 430 165</b>	KCA 30 S 44	<b>0 986 430 025</b>	KDAL 80 S 63	<b>0 986 430 094</b>	0 414 701 045	<b>0 414 701 045</b>
KBEL 117 P74	<b>0 986 430 166</b>	KCA 30 S 44	<b>0 986 430 026</b>	KDAL 80 S 63	<b>0 986 430 095</b>	0 414 702 003	<b>0 986 441 006</b>
KBEL 117 P74	<b>0 986 430 167</b>	KCA 30 S 44	<b>0 986 430 081</b>	KDAL 80 S 63	<b>0 986 430 563</b>	0 414 702 005	<b>0 986 441 006</b>
KBEL 48 P 38	<b>0 986 430 253</b>	KCA 30 S 44	<b>0 986 430 089</b>	K DEL 109 P47	<b>0 986 430 382</b>	0 414 702 006	<b>0 986 441 110</b>
KBEL 82 P 58	<b>0 986 430 367</b>	KCA 30 S 44	<b>0 986 430 184</b>	K DEL 109 P62	<b>0 986 430 390</b>	0 414 702 007	<b>0 986 441 111</b>
KBEL 95 P 9/4	<b>0 986 430 002</b>	KCA 30 S 44	<b>0 986 430 189</b>	KDEL 75 P 16	<b>0 986 430 347</b>	0 414 702 009	<b>0 986 441 109</b>
KBEL 98P 101	<b>0 986 430 498</b>	KCA 30 S 44	<b>0 986 430 208</b>	KDEL 75 P 20	<b>0 986 430 450</b>	0 414 702 010	<b>0 986 441 006</b>
KBEL 98P 102	<b>0 986 430 364</b>	KCA 30 S 44	<b>0 986 430 225</b>	KDEL 75 S 20	<b>0 986 430 445</b>	0 414 703 004	<b>0 986 441 025</b>
KBEL 98P 102	<b>0 986 430 368</b>	KCA 30 S 44	<b>0 986 430 234</b>	KDEL 77 P 59	<b>0 986 430 511</b>	0 414 703 008	<b>0 986 441 026</b>
KBEL 98P 102	<b>0 986 430 491</b>	KCA 30 S 44	<b>0 986 430 304</b>	KDEL 77 S 15	<b>0 986 430 334</b>	0 414 703 009	<b>0 986 441 027</b>
KBEL 98P 102	<b>0 986 430 591</b>	KCA 30 S 44	<b>0 986 430 520</b>	KDEL 77 S 15	<b>0 986 430 344</b>	0 414 720 007	<b>0 986 441 551</b>
KBEL 98P 102	<b>0 986 430 592</b>	KCA 30 S 46	<b>0 986 430 151</b>	KDEL 80 P 33	<b>0 986 430 090</b>	0 414 720 009	<b>0 986 441 552</b>
KBEL 98P 221	<b>0 986 430 593</b>	KCA 30 S 57	<b>0 986 430 176</b>	KDEL 80 P 33	<b>0 986 430 091</b>	0 414 720 013	<b>0 986 441 557</b>
KBEL 98 P 27	<b>0 986 430 162</b>	KCA 30 S 70	<b>0 986 430 249</b>	KDEL 80 P 33	<b>0 986 430 264</b>	0 414 720 014	<b>0 986 441 553</b>
KBEL 98 P 27	<b>0 986 430 163</b>	KCA 30 S 79	<b>0 986 430 187</b>	KDEL 80 P 33	<b>0 986 430 265</b>	0 414 720 015	<b>0 986 441 556</b>
KBEL 98 P 27	<b>0 986 430 492</b>	KCA 30 S 79	<b>0 986 430 188</b>	KDEL 80 P 33	<b>0 986 430 325</b>	0 414 720 016	<b>0 986 441 555</b>
KBEL 98 P 27	<b>0 986 430 494</b>	KCE 27 S 3	<b>0 986 430 245</b>	KDEL 80 P 33	<b>0 986 430 326</b>	0 414 720 018	<b>0 986 441 554</b>
KBEL 98 P 74	<b>0 986 430 311</b>	KCE 27 S 3	<b>0 986 430 307</b>	KDEL 80 P 33	<b>0 986 430 327</b>	0 414 720 021	<b>0 986 441 557</b>
KBEL 98 P 74	<b>0 986 430 363</b>	KCE 27 S 3	<b>0 986 430 388</b>	KDEL 80 P 33	<b>0 986 430 361</b>	0 414 720 022	<b>0 986 441 551</b>
KBEL 99 P 9/4	<b>0 986 430 033</b>	KCE 30 S 5	<b>0 986 430 381</b>	KDEL 80 P 33	<b>0 986 430 378</b>	0 414 720 023	<b>0 986 441 554</b>
KBE 58 S 4/4	<b>0 986 430 144</b>	KCE 30 S 6	<b>0 986 430 371</b>	KDEL 82 P 12	<b>0 986 430 312</b>	0 414 720 024	<b>0 986 441 553</b>
KBE 58 S 8	<b>0 986 430 532</b>	KDAL 74 S 21/19	<b>0 986 430 046</b>	KDEL 82 P 12	<b>0 986 430 321</b>	0 414 720 025	<b>0 986 441 556</b>
KBL 112 S 21/13	<b>0 986 430 064</b>	KDAL 74 S 21/19	<b>0 986 430 055</b>	KDEL 82 P 12	<b>0 986 430 451</b>	0 414 720 028	<b>0 986 441 557</b>
KBL7 6S2 114	<b>0 986 430 342</b>	K DAL 74S 319	<b>0 986 430 045</b>	KDEL 82 P 18	<b>0 986 430 252</b>	0 414 720 029	<b>0 986 441 554</b>
KCA 15 S 66	<b>0 986 430 198</b>	K DAL 74S 319	<b>0 986 430 046</b>	KDEL 82 P 18	<b>0 986 430 261</b>	0 414 720 030	<b>0 986 441 555</b>
KCA 15 S 66	<b>0 986 430 270</b>	K DAL 74S 319	<b>0 986 430 055</b>	KDEL 82 P 18	<b>0 986 430 362</b>	0 414 720 031	<b>0 986 441 555</b>
KCA 17 S 38/4	<b>0 986 430 010</b>	K DAL 74S 319	<b>0 986 430 056</b>	KDEL 82 P 23	<b>0 986 430 257</b>	0 414 720 033	<b>0 986 441 552</b>
KCA 17 S 42	<b>0 986 430 015</b>	KDAL 74 S 44	<b>0 986 430 178</b>	KDEL 82 P 38	<b>0 986 430 313</b>	0 414 720 034	<b>0 986 441 555</b>
KCA 17 S 42	<b>0 986 430 028</b>	KDAL 74 S 44	<b>0 986 430 210</b>	KDEL 82 P 7	<b>0 986 430 196</b>	0 414 720 035	<b>0 414 720 007</b>
KCA 17 S 42	<b>0 986 430 240</b>	KDAL 74 S 44	<b>0 986 430 214</b>	KDEL 82 P 7	<b>0 986 430 228</b>	0 414 720 035	<b>0 986 441 551</b>
KCA 17 S 42	<b>0 986 430 244</b>	KDAL 74 S 44	<b>0 986 430 221</b>	KDEL 95 S 17	<b>0 986 430 341</b>	0 414 720 036	<b>0 986 441 553</b>
KCA 17 S 42	<b>0 986 430 267</b>	KDAL 80 S 14/14	<b>0 986 430 038</b>	KDEL 95 S 21	<b>0 986 430 330</b>	0 414 720 037	<b>0 986 441 556</b>
KCA 17 S 42	<b>0 986 430 268</b>	KDAL 80 S 14/14	<b>0 986 430 042</b>	KDEL 96 S 22	<b>0 986 430 329</b>	0 414 720 038	<b>0 986 441 554</b>
KCA 17 S 42	<b>0 986 430 269</b>	KDAL 80 S 14/14	<b>0 986 430 053</b>	KDEL 97 P 10	<b>0 986 430 031</b>	0 414 720 039	<b>0 986 441 557</b>
KCA 17 S 42	<b>0 986 430 375</b>	KDAL 80 S 20/19	<b>0 986 430 159</b>	KDEL 97 P 10	<b>0 986 430 120</b>	0 414 720 201	<b>0 986 441 560</b>
KCA 17 S 42	<b>0 986 430 448</b>	KDAL 80 S 42	<b>0 986 430 038</b>	KDEL 97 P 13	<b>0 986 430 213</b>	0 414 720 202	<b>0 986 441 559</b>
KCA 17 S 70	<b>0 986 430 249</b>	KDAL 80 S 42	<b>0 986 430 042</b>	KDEL 97 P 13	<b>0 986 430 274</b>	0 414 720 204	<b>0 986 441 560</b>
KCA 21 S 71	<b>0 986 430 241</b>	KDAL 80 S 42	<b>0 986 430 053</b>	KDEL 97 P 3	<b>0 986 430 031</b>	0 414 720 206	<b>0 986 441 559</b>
KCA 21 S 71	<b>0 986 430 302</b>	KDAL 80 S 42	<b>0 986 430 168</b>	KDEL 97 S 11	<b>0 986 430 039</b>	0 414 720 208	<b>0 986 441 559</b>
KCA 27 S 55	<b>0 986 430 172</b>	KDAL 80 S 46	<b>0 986 430 133</b>	KDEL 99 P 15	<b>0 986 430 212</b>	0 414 720 209	<b>0 986 441 560</b>
KCA 27 S 55	<b>0 986 430 173</b>	KDAL 80 S 46	<b>0 986 430 205</b>	KDEL 99 P 39	<b>0 986 430 385</b>	0 414 720 210	<b>0 986 441 561</b>
KCA 27 S 55	<b>0 986 430 197</b>	KDAL 80 S 46	<b>0 986 430 211</b>	KDEL 99 P 39	<b>0 986 430 387</b>	0 414 720 213	<b>0 986 441 559</b>
KCA 27 S 55	<b>0 986 430 246</b>	KDAL 80 S 47	<b>0 986 430 038</b>	KDEL 99 P 5	<b>0 986 430 030</b>	0 414 720 214	<b>0 986 441 560</b>
KCA 27 S 55	<b>0 986 430 247</b>	KDAL 80 S 47	<b>0 986 430 042</b>	0 414 700 002	<b>0 986 441 102</b>	0 414 720 215	<b>0 986 441 559</b>
KCA 27 S 55	<b>0 986 430 505</b>	KDAL 80 S 47	<b>0 986 430 053</b>	0 414 700 003	<b>0 986 441 112</b>	0 414 720 216	<b>0 986 441 560</b>
KCA 27 S 77/	<b>0 986 430 206</b>	KDAL 80 S 47	<b>0 986 430 133</b>	0 414 701 004	<b>0 986 441 004</b>	0 414 720 220	<b>0 986 441 565</b>
KCA 27 S 77	<b>0 986 430 206</b>	KDAL 80 S 47	<b>0 986 430 168</b>	0 414 701 005	<b>0 986 441 101</b>	0 414 720 221	<b>0 986 441 562</b>
KCA 27 S 80	<b>0 986 430 449</b>	KDAL 80 S 47	<b>0 986 430 205</b>	0 414 701 006	<b>0 986 441 103</b>	0 414 720 222	<b>0 986 441 569</b>
KCA 27 S 81	<b>0 986 430 243</b>	KDAL 80 S 47	<b>0 986 430 211</b>	0 414 701 007	<b>0 986 441 107</b>	0 414 720 223	<b>0 986 441 570</b>
KCA 30 S 35/4	<b>0 986 430 171</b>	KDAL 80 S 47	<b>0 986 430 360</b>	0 414 701 008	<b>0 986 441 108</b>	0 414 720 224	<b>0 986 441 564</b>
KCA 30 S 36/4	<b>0 986 430 080</b>	KDAL 80 S 56	<b>0 986 430 159</b>	0 414 701 013	<b>0 986 441 113</b>	0 414 720 225	<b>0 986 441 563</b>
KCA 30 S 36/4	<b>0 986 430 190</b>	KDAL 80 S 59	<b>0 986 430 507</b>	0 414 701 017	<b>0 986 441 114</b>	0 414 720 226	<b>0 986 441 571</b>
KCA 30 S 36/4	<b>0 986 430 235</b>	KDAL 80 S 59	<b>0 986 430 508</b>	0 414 701 019	<b>0 986 441 115</b>	0 414 720 227	<b>0 986 441 572</b>
KCA 30 S 44	<b>0 986 430 020</b>	KDAL 80 S 63	<b>0 986 430 092</b>	0 414 701 020	<b>0 986 441 116</b>	0 414 720 228	<b>0 986 441 573</b>
KCA 30 S 44	<b>0 986 430 022</b>	KDAL 80 S 63	<b>0 986 430 093</b>	0 414 701 044	<b>0 414 701 044</b>	0 414 720 229	<b>0 986 441 574</b>



0 414 720 230	<b>0 986 441 575</b>	0 432 131 794	<b>0 986 430 252</b>	0 432 191 870	<b>0 986 430 033</b>	0 432 217 264	<b>0 986 430 190</b>
0 414 720 231	<b>0 986 441 560</b>	0 432 131 798	<b>0 986 430 261</b>	0 432 192 881	<b>0 986 430 034</b>	0 432 217 266	<b>0 986 430 247</b>
0 414 720 232	<b>0 986 441 564</b>	0 432 131 800	<b>0 986 430 264</b>	0 432 193 757	<b>0 986 430 522</b>	0 432 217 267	<b>0 986 430 304</b>
0 414 720 305	<b>0 986 441 576</b>	0 432 131 801	<b>0 986 430 265</b>	0 432 193 845	<b>0 986 430 256</b>	0 432 217 268	<b>0 986 430 381</b>
0 414 720 306	<b>0 986 441 567</b>	0 432 131 802	<b>0 986 430 378</b>	0 432 193 850	<b>0 986 430 253</b>	0 432 217 269	<b>0 986 430 371</b>
0 414 720 307	<b>0 986 441 568</b>	0 432 131 820	<b>0 986 430 257</b>	0 432 193 851	<b>0 986 430 253</b>	0 432 217 271	<b>0 986 430 187</b>
0 414 720 308	<b>0 986 441 577</b>	0 432 131 823	<b>0 986 430 450</b>	0 432 217 066	<b>0 986 430 171</b>	0 432 217 272	<b>0 986 430 187</b>
0 414 720 309	<b>0 986 441 578</b>	0 432 131 824	<b>0 986 430 212</b>	0 432 217 078	<b>0 986 430 080</b>	0 432 217 278	<b>0 986 430 302</b>
0 414 720 310	<b>0 986 441 579</b>	0 432 131 825	<b>0 986 430 213</b>	0 432 217 079	<b>0 986 430 080</b>	0 432 217 280	<b>0 986 430 388</b>
0 414 720 311	<b>0 986 441 576</b>	0 432 131 831	<b>0 986 430 228</b>	0 432 217 083	<b>0 986 430 081</b>	0 432 217 283	<b>0 986 430 206</b>
0 414 720 312	<b>0 986 441 567</b>	0 432 131 846	<b>0 986 430 274</b>	0 432 217 084	<b>0 986 430 081</b>	0 432 217 284	<b>0 986 430 206</b>
0 414 720 313	<b>0 986 441 568</b>	0 432 131 850	<b>0 986 430 031</b>	0 432 217 090	<b>0 986 430 010</b>	0 432 217 287	<b>0 986 430 307</b>
0 414 720 314	<b>0 986 441 577</b>	0 432 131 853	<b>0 986 430 196</b>	0 432 217 110	<b>0 986 430 089</b>	0 432 217 289	<b>0 986 430 375</b>
0 414 720 401	<b>0 986 441 580</b>	0 432 131 857	<b>0 986 430 321</b>	0 432 217 111	<b>0 986 430 015</b>	0 432 217 290	<b>0 986 430 505</b>
0 414 720 402	<b>0 986 441 580</b>	0 432 131 860	<b>0 986 430 196</b>	0 432 217 111	<b>0 986 430 028</b>	0 432 217 293	<b>0 986 430 520</b>
0 414 720 403	<b>0 986 441 580</b>	0 432 131 866	<b>0 986 430 228</b>	0 432 217 113	<b>0 986 430 089</b>	0 432 217 299	<b>0 986 430 449</b>
0 414 720 404	<b>0 986 441 566</b>	0 432 131 871	<b>0 986 430 120</b>	0 432 217 118	<b>0 986 430 089</b>	0 432 231 599	<b>0 986 430 563</b>
0 414 755 002	<b>0 986 445 001</b>	0 432 131 873	<b>0 986 430 030</b>	0 432 217 125	<b>0 986 430 151</b>	0 432 231 659	<b>0 986 430 095</b>
0 414 755 003	<b>0 986 445 001</b>	0 432 131 878	<b>0 986 430 031</b>	0 432 217 131	<b>0 986 430 022</b>	0 432 231 661	<b>0 986 430 092</b>
0 414 755 006	<b>0 986 445 008</b>	0 432 133 855	<b>0 986 430 313</b>	0 432 217 141	<b>0 986 430 025</b>	0 432 231 663	<b>0 986 430 093</b>
0 414 755 007	<b>0 986 445 008</b>	0 432 191 405	<b>0 986 430 593</b>	0 432 217 142	<b>0 986 430 020</b>	0 432 231 664	<b>0 986 430 094</b>
0 414 755 014	<b>0 986 445 011</b>	0 432 191 460	<b>0 986 430 592</b>	0 432 217 146	<b>0 986 430 026</b>	0 432 231 665	<b>0 986 430 205</b>
0 414 755 015	<b>0 986 445 011</b>	0 432 191 506	<b>0 986 430 591</b>	0 432 217 147	<b>0 986 430 184</b>	0 432 231 667	<b>0 986 430 330</b>
0 414 799 001	<b>0 986 445 002</b>	0 432 191 529	<b>0 986 430 491</b>	0 432 217 153	<b>0 986 430 028</b>	0 432 231 668	<b>0 986 430 329</b>
0 414 799 001	<b>0 986 445 102</b>	0 432 191 611	<b>0 986 430 370</b>	0 432 217 157	<b>0 986 430 197</b>	0 432 231 673	<b>0 986 430 507</b>
0 414 799 003	<b>0 986 445 003</b>	0 432 191 612	<b>0 986 430 369</b>	0 432 217 161	<b>0 986 430 172</b>	0 432 231 674	<b>0 986 430 508</b>
0 414 799 003	<b>0 986 445 103</b>	0 432 191 616	<b>0 986 430 348</b>	0 432 217 165	<b>0 986 430 190</b>	0 432 231 676	<b>0 986 430 360</b>
0 414 799 004	<b>0 986 445 003</b>	0 432 191 630	<b>0 986 430 349</b>	0 432 217 169	<b>0 986 430 173</b>	0 432 231 677	<b>0 986 430 211</b>
0 414 799 004	<b>0 986 445 103</b>	0 432 191 633	<b>0 986 430 352</b>	0 432 217 186	<b>0 986 430 176</b>	0 432 231 678	<b>0 986 430 205</b>
0 414 799 005	<b>0 986 445 002</b>	0 432 191 634	<b>0 986 430 368</b>	0 432 217 188	<b>0 986 430 208</b>	0 432 231 680	<b>0 986 430 038</b>
0 414 799 005	<b>0 986 445 102</b>	0 432 191 635	<b>0 986 430 367</b>	0 432 217 191	<b>0 986 430 198</b>	0 432 231 684	<b>0 986 430 042</b>
0 414 799 006	<b>0 986 445 003</b>	0 432 191 655	<b>0 986 430 490</b>	0 432 217 196	<b>0 986 430 448</b>	0 432 231 687	<b>0 986 430 053</b>
0 414 799 006	<b>0 986 445 103</b>	0 432 191 658	<b>0 986 430 498</b>	0 432 217 198	<b>0 986 430 189</b>	0 432 231 688	<b>0 986 430 221</b>
0 414 799 008	<b>0 986 445 003</b>	0 432 191 669	<b>0 986 430 364</b>	0 432 217 206	<b>0 986 430 234</b>	0 432 231 699	<b>0 986 430 445</b>
0 414 799 008	<b>0 986 445 103</b>	0 432 191 694	<b>0 986 430 447</b>	0 432 217 207	<b>0 986 430 189</b>	0 432 231 702	<b>0 986 430 341</b>
0 414 799 009	<b>0 986 445 110</b>	0 432 191 710	<b>0 986 430 366</b>	0 432 217 210	<b>0 986 430 234</b>	0 432 231 703	<b>0 986 430 168</b>
0 414 799 016	<b>0 986 445 114</b>	0 432 191 715	<b>0 986 430 354</b>	0 432 217 214	<b>0 986 430 235</b>	0 432 231 704	<b>0 986 430 133</b>
0 414 799 023	<b>0 986 445 115</b>	0 432 191 719	<b>0 986 430 359</b>	0 432 217 215	<b>0 986 430 235</b>	0 432 231 713	<b>0 986 430 210</b>
0 430 211 079	<b>0 986 430 249</b>	0 432 191 721	<b>0 986 430 250</b>	0 432 217 218	<b>0 986 430 240</b>	0 432 231 714	<b>0 986 430 211</b>
0 432 131 632	<b>0 986 430 090</b>	0 432 191 724	<b>0 986 430 311</b>	0 432 217 222	<b>0 986 430 249</b>	0 432 231 717	<b>0 986 430 205</b>
0 432 131 667	<b>0 986 430 196</b>	0 432 191 730	<b>0 986 430 263</b>	0 432 217 223	<b>0 986 430 241</b>	0 432 231 722	<b>0 986 430 214</b>
0 432 131 703	<b>0 986 430 390</b>	0 432 191 736	<b>0 986 430 363</b>	0 432 217 226	<b>0 986 430 268</b>	0 432 231 724	<b>0 986 430 221</b>
0 432 131 707	<b>0 986 430 091</b>	0 432 191 737	<b>0 986 430 353</b>	0 432 217 237	<b>0 986 430 270</b>	0 432 231 736	<b>0 986 430 178</b>
0 432 131 714	<b>0 986 430 511</b>	0 432 191 759	<b>0 986 430 332</b>	0 432 217 239	<b>0 986 430 187</b>	0 432 231 741	<b>0 986 430 344</b>
0 432 131 726	<b>0 986 430 326</b>	0 432 191 770	<b>0 986 430 165</b>	0 432 217 240	<b>0 986 430 187</b>	0 432 231 747	<b>0 986 430 334</b>
0 432 131 727	<b>0 986 430 325</b>	0 432 191 771	<b>0 986 430 166</b>	0 432 217 241	<b>0 986 430 188</b>	0 432 231 760	<b>0 986 430 168</b>
0 432 131 728	<b>0 986 430 327</b>	0 432 191 778	<b>0 986 430 492</b>	0 432 217 242	<b>0 986 430 188</b>	0 432 231 764	<b>0 986 430 038</b>
0 432 131 751	<b>0 986 430 387</b>	0 432 191 788	<b>0 986 430 167</b>	0 432 217 243	<b>0 986 430 206</b>	0 432 231 766	<b>0 986 430 133</b>
0 432 131 758	<b>0 986 430 382</b>	0 432 191 801	<b>0 986 430 494</b>	0 432 217 244	<b>0 986 430 206</b>	0 432 231 778	<b>0 986 430 159</b>
0 432 131 760	<b>0 986 430 451</b>	0 432 191 815	<b>0 986 430 164</b>	0 432 217 246	<b>0 986 430 243</b>	0 432 231 797	<b>0 986 430 038</b>
0 432 131 767	<b>0 986 430 347</b>	0 432 191 822	<b>0 986 430 162</b>	0 432 217 248	<b>0 986 430 244</b>	0 432 231 799	<b>0 986 430 039</b>
0 432 131 773	<b>0 986 430 385</b>	0 432 191 825	<b>0 986 430 163</b>	0 432 217 253	<b>0 986 430 245</b>	0 432 231 814	<b>0 986 430 042</b>
0 432 131 781	<b>0 986 430 361</b>	0 432 191 848	<b>0 986 430 000</b>	0 432 217 258	<b>0 986 430 269</b>	0 432 231 823	<b>0 986 430 045</b>
0 432 131 788	<b>0 986 430 312</b>	0 432 191 854	<b>0 986 430 002</b>	0 432 217 262	<b>0 986 430 246</b>	0 432 231 824	<b>0 986 430 046</b>
0 432 131 793	<b>0 986 430 362</b>	0 432 191 863	<b>0 986 430 032</b>	0 432 217 263	<b>0 986 430 267</b>	0 432 231 873	<b>0 986 430 053</b>



## ◀ BOSCH-EXCHANGE

0 432 231 886	<b>0 986 430 055</b>	0 445 010 030	<b>0 445 010 275</b>	0 445 010 129	<b>0 445 010 294</b>	0 445 010 334	<b>0 986 437 360</b>
0 432 231 887	<b>0 986 430 056</b>	0 445 010 030	<b>0 986 437 106</b>	0 445 010 132	<b>0 986 437 018</b>	0 445 010 335	<b>0 986 437 316</b>
0 432 281 695	<b>0 986 430 342</b>	0 445 010 031	<b>0 986 437 301</b>	0 445 010 135	<b>0 986 437 363</b>	0 445 010 339	<b>0 986 437 367</b>
0 432 291 534	<b>0 986 430 301</b>	0 445 010 033	<b>0 986 437 302</b>	0 445 010 137	<b>0 986 437 085</b>	0 445 010 340	<b>0 445 010 340</b>
0 432 291 558	<b>0 986 430 337</b>	0 445 010 036	<b>0 986 437 316</b>	0 445 010 138	<b>0 445 010 278</b>	0 445 010 340	<b>0 986 437 344</b>
0 432 291 621	<b>0 986 430 338</b>	0 445 010 038	<b>0 445 010 279</b>	0 445 010 139	<b>0 445 010 367</b>	0 445 010 342	<b>0 445 010 342</b>
0 432 291 635	<b>0 986 430 169</b>	0 445 010 038	<b>0 986 437 020</b>	0 445 010 143	<b>0 986 437 364</b>	0 445 010 343	<b>0 445 010 343</b>
0 432 291 661	<b>0 986 430 203</b>	0 445 010 038	<b>0 986 437 080</b>	0 445 010 145	<b>0 986 437 365</b>	0 445 010 343	<b>0 986 437 348</b>
0 432 291 672	<b>0 986 430 336</b>	0 445 010 042	<b>0 986 437 309</b>	0 445 010 149	<b>0 445 010 347</b>	0 445 010 344	<b>0 445 010 344</b>
0 432 291 710	<b>0 986 430 333</b>	0 445 010 043	<b>0 986 437 312</b>	0 445 010 150	<b>0 445 010 286</b>	0 445 010 344	<b>0 986 437 362</b>
0 432 291 718	<b>0 986 430 141</b>	0 445 010 046	<b>0 986 437 017</b>	0 445 010 155	<b>0 445 010 287</b>	0 445 010 345	<b>0 986 437 363</b>
0 432 291 753	<b>0 986 430 067</b>	0 445 010 047	<b>0 445 010 112</b>	0 445 010 155	<b>0 986 437 026</b>	0 445 010 346	<b>0 986 437 364</b>
0 432 291 807	<b>0 986 430 124</b>	0 445 010 050	<b>0 445 010 280</b>	0 445 010 156	<b>0 445 010 288</b>	0 445 010 347	<b>0 445 010 347</b>
0 432 292 881	<b>0 986 430 074</b>	0 445 010 050	<b>0 986 437 021</b>	0 445 010 156	<b>0 986 437 025</b>	0 445 010 348	<b>0 445 010 348</b>
0 432 297 034	<b>0 986 430 144</b>	0 445 010 050	<b>0 986 437 081</b>	0 445 010 157	<b>0 445 010 293</b>	0 445 010 356	<b>0 986 437 365</b>
0 432 297 057	<b>0 986 430 532</b>	0 445 010 052	<b>0 445 010 354</b>	0 445 010 157	<b>0 986 437 086</b>	0 445 010 358	<b>0 986 437 346</b>
0 444 010 009	<b>0 986 44D 002</b>	0 445 010 063	<b>0 986 437 028</b>	0 445 010 162	<b>0 445 010 282</b>	0 445 010 360	<b>0 445 010 360</b>
0 444 010 020	<b>0 986 44D 002</b>	0 445 010 073	<b>0 986 437 320</b>	0 445 010 162	<b>0 986 437 005</b>	0 445 010 507	<b>0 445 010 546</b>
0 444 022 001	<b>0 986 44D 106</b>	0 445 010 074	<b>0 986 437 314</b>	0 445 010 163	<b>0 445 010 283</b>	0 445 010 507	<b>0 986 437 408</b>
0 444 022 005	<b>0 986 44D 102</b>	0 445 010 075	<b>0 986 437 301</b>	0 445 010 163	<b>0 986 437 017</b>	0 445 010 508	<b>0 445 010 543</b>
0 444 022 014	<b>0 444 022 016</b>	0 445 010 078	<b>0 986 437 364</b>	0 445 010 164	<b>0 445 010 284</b>	0 445 010 508	<b>0 986 437 410</b>
0 444 022 015	<b>0 444 022 016</b>	0 445 010 079	<b>0 445 010 281</b>	0 445 010 164	<b>0 986 437 018</b>	0 445 010 511	<b>0 445 010 544</b>
0 444 022 017	<b>0 444 022 020</b>	0 445 010 079	<b>0 986 437 022</b>	0 445 010 171	<b>0 445 010 331</b>	0 445 010 512	<b>0 445 010 545</b>
0 444 022 018	<b>0 444 022 020</b>	0 445 010 080	<b>0 445 010 276</b>	0 445 010 171	<b>0 986 437 093</b>	0 445 010 514	<b>0 986 437 412</b>
0 444 022 019	<b>0 986 44D 106</b>	0 445 010 080	<b>0 986 437 023</b>	0 445 010 180	<b>0 445 010 332</b>	0 445 010 521	<b>0 445 010 547</b>
0 444 022 022	<b>0 444 022 024</b>	0 445 010 082	<b>0 445 010 358</b>	0 445 010 181	<b>0 986 437 085</b>	0 445 010 523	<b>0 986 437 420</b>
0 444 022 023	<b>0 444 022 024</b>	0 445 010 082	<b>0 986 437 346</b>	0 445 010 184	<b>0 445 010 365</b>	0 445 010 543	<b>0 445 010 543</b>
0 444 022 025	<b>0 444 022 029</b>	0 445 010 085	<b>0 445 010 114</b>	0 445 010 193	<b>0 445 010 371</b>	0 445 010 544	<b>0 445 010 544</b>
0 444 022 035	<b>0 444 022 037</b>	0 445 010 086	<b>0 986 437 317</b>	0 445 010 196	<b>0 445 010 295</b>	0 445 010 545	<b>0 445 010 545</b>
0 445 010 006	<b>0 986 437 001</b>	0 445 010 089	<b>0 986 437 322</b>	0 445 010 203	<b>0 445 010 278</b>	0 445 010 546	<b>0 445 010 546</b>
0 445 010 007	<b>0 986 437 002</b>	0 445 010 089	<b>0 986 437 325</b>	0 445 010 204	<b>0 445 010 293</b>	0 445 010 547	<b>0 445 010 547</b>
0 445 010 008	<b>0 445 010 268</b>	0 445 010 091	<b>0 986 437 366</b>	0 445 010 205	<b>0 445 010 351</b>	0 445 010 611	<b>0 445 010 659</b>
0 445 010 008	<b>0 986 437 100</b>	0 445 010 092	<b>0 445 010 277</b>	0 445 010 206	<b>0 445 010 290</b>	0 445 010 613	<b>0 445 010 654</b>
0 445 010 009	<b>0 986 437 004</b>	0 445 010 092	<b>0 986 437 024</b>	0 445 010 211	<b>0 445 010 360</b>	0 445 010 618	<b>0 445 010 655</b>
0 445 010 010	<b>0 986 437 005</b>	0 445 010 095	<b>0 986 437 363</b>	0 445 010 231	<b>0 445 010 349</b>	0 445 010 619	<b>0 986 437 414</b>
0 445 010 011	<b>0 986 437 006</b>	0 445 010 097	<b>0 986 437 025</b>	0 445 010 232	<b>0 445 010 350</b>	0 445 010 620	<b>0 986 437 416</b>
0 445 010 012	<b>0 986 437 313</b>	0 445 010 099	<b>0 986 437 355</b>	0 445 010 241	<b>0 445 010 291</b>	0 445 010 624	<b>0 986 437 418</b>
0 445 010 013	<b>0 445 010 269</b>	0 445 010 101	<b>0 445 010 355</b>	0 445 010 243	<b>0 445 010 292</b>	0 445 010 629	<b>0 445 010 662</b>
0 445 010 013	<b>0 986 437 101</b>	0 445 010 102	<b>0 445 010 296</b>	0 445 010 246	<b>0 445 010 363</b>	0 445 010 640	<b>0 445 010 656</b>
0 445 010 014	<b>0 445 010 270</b>	0 445 010 102	<b>0 986 437 028</b>	0 445 010 264	<b>0 445 010 348</b>	0 445 010 641	<b>0 445 010 657</b>
0 445 010 014	<b>0 986 437 102</b>	0 445 010 108	<b>0 986 437 315</b>	0 445 010 266	<b>0 445 010 265</b>	0 445 010 642	<b>0 445 010 658</b>
0 445 010 015	<b>0 986 437 009</b>	0 445 010 117	<b>0 986 437 367</b>	0 445 010 268	<b>0 986 437 100</b>	0 445 010 646	<b>0 445 010 673</b>
0 445 010 018	<b>0 986 437 010</b>	0 445 010 119	<b>0 445 010 340</b>	0 445 010 269	<b>0 986 437 101</b>	0 445 010 655	<b>0 445 010 655</b>
0 445 010 019	<b>0 445 010 271</b>	0 445 010 119	<b>0 986 437 344</b>	0 445 010 270	<b>0 986 437 102</b>	0 445 010 656	<b>0 445 010 656</b>
0 445 010 019	<b>0 986 437 104</b>	0 445 010 120	<b>0 986 437 368</b>	0 445 010 271	<b>0 986 437 104</b>	0 445 010 657	<b>0 445 010 657</b>
0 445 010 021	<b>0 986 437 012</b>	0 445 010 121	<b>0 445 010 342</b>	0 445 010 272	<b>0 986 437 103</b>	0 445 010 658	<b>0 445 010 658</b>
0 445 010 024	<b>0 445 010 272</b>	0 445 010 121	<b>0 986 437 354</b>	0 445 010 273	<b>0 986 437 019</b>	0 445 010 659	<b>0 445 010 659</b>
0 445 010 024	<b>0 986 437 103</b>	0 445 010 122	<b>0 986 437 086</b>	0 445 010 274	<b>0 986 437 105</b>	0 445 010 662	<b>0 445 010 662</b>
0 445 010 025	<b>0 445 010 273</b>	0 445 010 123	<b>0 445 010 285</b>	0 445 010 275	<b>0 986 437 106</b>	0 445 020 002	<b>0 986 437 501</b>
0 445 010 025	<b>0 986 437 019</b>	0 445 010 124	<b>0 445 010 289</b>	0 445 010 280	<b>0 986 437 081</b>	0 445 020 006	<b>0 986 437 502</b>
0 445 010 027	<b>0 445 010 274</b>	0 445 010 125	<b>0 445 010 343</b>	0 445 010 281	<b>0 986 437 022</b>	0 445 020 007	<b>0 986 437 341</b>
0 445 010 027	<b>0 986 437 105</b>	0 445 010 125	<b>0 986 437 348</b>	0 445 010 285	<b>0 445 010 123</b>	0 445 020 008	<b>0 986 437 318</b>
0 445 010 028	<b>0 986 437 015</b>	0 445 010 126	<b>0 986 437 323</b>	0 445 010 296	<b>0 986 437 028</b>	0 445 020 011	<b>0 986 437 304</b>
0 445 010 029	<b>0 445 010 334</b>	0 445 010 127	<b>0 445 010 344</b>	0 445 010 305	<b>0 445 010 304</b>	0 445 020 017	<b>0 986 437 303</b>
0 445 010 029	<b>0 986 437 360</b>	0 445 010 127	<b>0 986 437 362</b>	0 445 010 331	<b>0 445 010 331</b>	0 445 020 018	<b>0 986 437 353</b>

0 445 020 023	<b>0 986 437 351</b>	0 445 110 075	<b>0 986 435 076</b>	0 445 110 172	<b>0 986 435 145</b>	0 445 110 265	<b>0 986 435 170</b>
0 445 020 030	<b>0 986 437 308</b>	0 445 110 076	<b>0 986 435 077</b>	0 445 110 175	<b>0 986 435 089</b>	0 445 110 266	<b>0 986 435 022</b>
0 445 020 039	<b>0 986 437 304</b>	0 445 110 078	<b>0 986 435 120</b>	0 445 110 176	<b>0 986 435 111</b>	0 445 110 268	<b>0 445 110 267</b>
0 445 020 045	<b>0 986 437 342</b>	0 445 110 080	<b>0 986 435 084</b>	0 445 110 177	<b>0 986 435 111</b>	0 445 110 269	<b>0 986 435 153</b>
0 445 020 060	<b>0 986 437 352</b>	0 445 110 083	<b>0 986 435 078</b>	0 445 110 181	<b>0 986 435 053</b>	0 445 110 270	<b>0 445 110 269</b>
0 445 020 075	<b>0 986 437 350</b>	0 445 110 087	<b>0 986 435 079</b>	0 445 110 182	<b>0 986 435 053</b>	0 445 110 270	<b>0 986 435 153</b>
0 445 020 147	<b>0 986 437 304</b>	0 445 110 089	<b>0 986 435 033</b>	0 445 110 183	<b>0 986 435 102</b>	0 445 110 273	<b>0 986 435 165</b>
0 445 020 150	<b>0 986 437 342</b>	0 445 110 090	<b>0 986 435 033</b>	0 445 110 185	<b>0 445 110 283</b>	0 445 110 275	<b>0 445 110 274</b>
0 445 110 002	<b>0 986 435 001</b>	0 445 110 091	<b>0 986 435 154</b>	0 445 110 187	<b>0 986 435 099</b>	0 445 110 276	<b>0 986 435 148</b>
0 445 110 005	<b>0 986 435 005</b>	0 445 110 092	<b>0 986 435 154</b>	0 445 110 188	<b>0 986 435 090</b>	0 445 110 278	<b>0 445 110 277</b>
0 445 110 006	<b>0 986 435 005</b>	0 445 110 093	<b>0 986 435 035</b>	0 445 110 191	<b>0 986 435 114</b>	0 445 110 281	<b>0 986 435 150</b>
0 445 110 007	<b>0 986 435 010</b>	0 445 110 094	<b>0 986 435 035</b>	0 445 110 195	<b>0 986 435 057</b>	0 445 110 294	<b>0 986 435 159</b>
0 445 110 008	<b>0 445 110 044</b>	0 445 110 095	<b>0 986 435 037</b>	0 445 110 196	<b>0 986 435 057</b>	0 445 110 295	<b>0 986 435 159</b>
0 445 110 008	<b>0 986 435 003</b>	0 445 110 096	<b>0 986 435 037</b>	0 445 110 197	<b>0 986 435 059</b>	0 445 110 297	<b>0 986 435 150</b>
0 445 110 010	<b>0 986 435 004</b>	0 445 110 097	<b>0 986 435 039</b>	0 445 110 198	<b>0 986 435 059</b>	0 445 110 311	<b>0 986 435 146</b>
0 445 110 011	<b>0 986 435 004</b>	0 445 110 098	<b>0 986 435 039</b>	0 445 110 199	<b>0 986 435 061</b>	0 445 110 368	<b>0 986 435 166</b>
0 445 110 012	<b>0 986 435 004</b>	0 445 110 099	<b>0 986 435 041</b>	0 445 110 200	<b>0 986 435 061</b>	0 445 110 429	<b>0 445 110 437</b>
0 445 110 013	<b>0 986 435 009</b>	0 445 110 100	<b>0 986 435 041</b>	0 445 110 201	<b>0 986 435 063</b>	0 445 115 003	<b>0 986 435 358</b>
0 445 110 014	<b>0 986 435 005</b>	0 445 110 101	<b>0 986 435 147</b>	0 445 110 202	<b>0 986 435 063</b>	0 445 115 004	<b>0 986 435 358</b>
0 445 110 015	<b>0 986 435 005</b>	0 445 110 103	<b>0 986 435 043</b>	0 445 110 203	<b>0 986 435 065</b>	0 445 115 007	<b>0 986 435 350</b>
0 445 110 016	<b>0 986 435 011</b>	0 445 110 104	<b>0 986 435 043</b>	0 445 110 204	<b>0 986 435 065</b>	0 445 115 018	<b>0 986 435 353</b>
0 445 110 019	<b>0 986 435 006</b>	0 445 110 105	<b>0 986 435 045</b>	0 445 110 205	<b>0 986 435 067</b>	0 445 115 025	<b>0 986 435 351</b>
0 445 110 021	<b>0 986 435 007</b>	0 445 110 106	<b>0 986 435 045</b>	0 445 110 206	<b>0 986 435 067</b>	0 445 115 026	<b>0 986 435 355</b>
0 445 110 022	<b>0 986 435 008</b>	0 445 110 107	<b>0 986 435 047</b>	0 445 110 207	<b>0 986 435 069</b>	0 445 115 027	<b>0 986 435 355</b>
0 445 110 023	<b>0 986 435 008</b>	0 445 110 108	<b>0 986 435 047</b>	0 445 110 208	<b>0 986 435 069</b>	0 445 115 028	<b>0 986 435 352</b>
0 445 110 024	<b>0 986 435 020</b>	0 445 110 109	<b>0 986 435 100</b>	0 445 110 209	<b>0 986 435 144</b>	0 445 115 029	<b>0 986 435 352</b>
0 445 110 025	<b>0 986 435 020</b>	0 445 110 110	<b>0 986 435 080</b>	0 445 110 212	<b>0 986 435 151</b>	0 445 115 032	<b>0 986 435 356</b>
0 445 110 028	<b>0 986 435 009</b>	0 445 110 111	<b>0 986 435 081</b>	0 445 110 213	<b>0 986 435 162</b>	0 445 115 033	<b>0 986 435 356</b>
0 445 110 029	<b>0 986 435 010</b>	0 445 110 112	<b>0 986 435 101</b>	0 445 110 216	<b>0 986 435 091</b>	0 445 115 034	<b>0 986 435 358</b>
0 445 110 030	<b>0 986 435 011</b>	0 445 110 115	<b>0 986 435 049</b>	0 445 110 219	<b>0 986 435 092</b>	0 445 115 035	<b>0 986 435 358</b>
0 445 110 034	<b>0 986 435 012</b>	0 445 110 116	<b>0 986 435 049</b>	0 445 110 222	<b>0 986 435 160</b>	0 445 115 036	<b>0 986 435 358</b>
0 445 110 035	<b>0 986 435 012</b>	0 445 110 118	<b>0 986 435 082</b>	0 445 110 223	<b>0 445 110 222</b>	0 445 115 037	<b>0 986 435 358</b>
0 445 110 036	<b>0 986 435 013</b>	0 445 110 119	<b>0 986 435 083</b>	0 445 110 223	<b>0 986 435 160</b>	0 445 115 038	<b>0 986 435 353</b>
0 445 110 036	<b>0 986 435 014</b>	0 445 110 130	<b>0 986 435 096</b>	0 445 110 230	<b>0 986 435 124</b>	0 445 115 039	<b>0 986 435 353</b>
0 445 110 036	<b>0 986 435 015</b>	0 445 110 131	<b>0 986 435 084</b>	0 445 110 236	<b>0 986 435 145</b>	0 445 115 048	<b>0 986 435 354</b>
0 445 110 038	<b>0 986 435 016</b>	0 445 110 135	<b>0 986 435 085</b>	0 445 110 237	<b>0 986 435 139</b>	0 445 115 050	<b>0 986 435 359</b>
0 445 110 044	<b>0 986 435 002</b>	0 445 110 136	<b>0 986 435 090</b>	0 445 110 238	<b>0 986 435 139</b>	0 445 115 051	<b>0 986 435 358</b>
0 445 110 044	<b>0 986 435 003</b>	0 445 110 139	<b>0 986 435 107</b>	0 445 110 239	<b>0 986 435 122</b>	0 445 115 052	<b>0 986 435 358</b>
0 445 110 047	<b>0 986 435 022</b>	0 445 110 140	<b>0 986 435 107</b>	0 445 110 243	<b>0 986 435 104</b>	0 445 115 053	<b>0 986 435 353</b>
0 445 110 048	<b>0 986 435 094</b>	0 445 110 141	<b>0 986 435 086</b>	0 445 110 244	<b>0 986 435 161</b>	0 445 115 054	<b>0 986 435 353</b>
0 445 110 049	<b>0 986 435 095</b>	0 445 110 146	<b>0 986 435 007</b>	0 445 110 247	<b>0 986 435 163</b>	0 445 115 057	<b>0 986 435 364</b>
0 445 110 054	<b>0 986 435 133</b>	0 445 110 149	<b>0 986 435 157</b>	0 445 110 248	<b>0 986 435 163</b>	0 445 115 058	<b>0 986 435 364</b>
0 445 110 055	<b>0 986 435 133</b>	0 445 110 150	<b>0 986 435 124</b>	0 445 110 251	<b>0 986 435 125</b>	0 445 115 063	<b>0 986 435 355</b>
0 445 110 057	<b>0 986 435 093</b>	0 445 110 155	<b>0 986 435 135</b>	0 445 110 252	<b>0 986 435 143</b>	0 445 115 064	<b>0 986 435 355</b>
0 445 110 059	<b>0 986 435 149</b>	0 445 110 156	<b>0 986 435 135</b>	0 445 110 253	<b>0 986 435 155</b>	0 445 115 068	<b>0 986 435 356</b>
0 445 110 062	<b>0 986 435 077</b>	0 445 110 157	<b>0 986 435 168</b>	0 445 110 254	<b>0 445 110 253</b>	0 445 115 069	<b>0 986 435 356</b>
0 445 110 063	<b>0 986 435 075</b>	0 445 110 159	<b>0 986 435 088</b>	0 445 110 254	<b>0 986 435 155</b>	0 445 115 070	<b>0 986 435 354</b>
0 445 110 064	<b>0 445 110 101</b>	0 445 110 160	<b>0 986 435 098</b>	0 445 110 255	<b>0 986 435 152</b>	0 445 115 071	<b>0 986 435 355</b>
0 445 110 064	<b>0 986 435 147</b>	0 445 110 161	<b>0 986 435 091</b>	0 445 110 256	<b>0 445 110 255</b>	0 445 115 072	<b>0 986 435 355</b>
0 445 110 068	<b>0 986 435 083</b>	0 445 110 165	<b>0 986 435 103</b>	0 445 110 256	<b>0 986 435 152</b>	0 445 115 073	<b>0 986 435 356</b>
0 445 110 070	<b>0 986 435 158</b>	0 445 110 166	<b>0 986 435 118</b>	0 445 110 257	<b>0 986 435 156</b>	0 445 115 077	<b>0 986 435 359</b>
0 445 110 071	<b>0 986 435 071</b>	0 445 110 167	<b>0 986 435 118</b>	0 445 110 258	<b>0 445 110 257</b>	0 445 115 078	<b>0 986 435 358</b>
0 445 110 072	<b>0 986 435 071</b>	0 445 110 168	<b>0 445 110 279</b>	0 445 110 258	<b>0 986 435 156</b>	0 445 115 079	<b>0 986 435 358</b>
0 445 110 073	<b>0 986 435 031</b>	0 445 110 170	<b>0 986 435 164</b>	0 445 110 263	<b>0 986 435 115</b>	0 445 115 080	<b>0 986 435 353</b>
0 445 110 074	<b>0 986 435 031</b>	0 445 110 171	<b>0 986 435 164</b>	0 445 110 264	<b>0 986 435 115</b>	0 445 115 080	<b>0 986 435 388</b>



## ◀ BOSCH-EXCHANGE

0 445 115 082	<b>0 986 435 372</b>	0 460 404 961	<b>0 986 440 570</b>	0 460 414 123	<b>0 986 440 048</b>	0 460 485 003	<b>0 986 440 242</b>
0 445 115 085	<b>0 986 435 364</b>	0 460 404 964	<b>0 986 440 551</b>	0 460 414 140	<b>0 986 440 051</b>	0 460 485 017	<b>0 986 440 242</b>
0 445 115 085	<b>0 986 435 374</b>	0 460 404 966	<b>0 986 440 552</b>	0 460 414 141	<b>0 986 440 052</b>	0 460 485 019	<b>0 986 440 256</b>
0 445 115 086	<b>0 986 435 364</b>	0 460 404 967	<b>0 986 440 553</b>	0 460 414 142	<b>0 986 440 217</b>	0 460 485 023	<b>0 986 440 256</b>
0 445 116 002	<b>0 986 435 377</b>	0 460 404 968	<b>0 986 440 567</b>	0 460 414 145	<b>0 986 440 053</b>	0 460 485 024	<b>0 986 440 252</b>
0 445 116 004	<b>0 986 435 360</b>	0 460 404 969	<b>0 986 440 554</b>	0 460 414 146	<b>0 986 440 054</b>	0 460 485 025	<b>0 986 440 256</b>
0 445 116 005	<b>0 986 435 360</b>	0 460 404 970	<b>0 986 440 568</b>	0 460 414 150	<b>0 986 440 055</b>	0 460 485 027	<b>0 986 440 243</b>
0 445 116 010	<b>0 986 435 367</b>	0 460 404 971	<b>0 986 440 555</b>	0 460 414 152	<b>0 986 440 056</b>	0 460 485 028	<b>0 986 440 243</b>
0 445 116 014	<b>0 986 435 357</b>	0 460 404 972	<b>0 986 440 556</b>	0 460 414 153	<b>0 986 440 219</b>	0 460 485 029	<b>0 986 440 252</b>
0 445 116 015	<b>0 986 435 357</b>	0 460 404 973	<b>0 986 440 507</b>	0 460 414 987	<b>0 986 440 561</b>	0 460 485 030	<b>0 986 440 243</b>
0 445 116 022	<b>0 986 435 357</b>	0 460 404 974	<b>0 986 440 508</b>	0 460 414 988	<b>0 986 440 520</b>	0 460 485 033	<b>0 986 440 254</b>
0 445 116 023	<b>0 986 435 357</b>	0 460 404 976	<b>0 986 440 553</b>	0 460 414 989	<b>0 986 440 561</b>	0 460 485 035	<b>0 986 440 244</b>
0 445 116 026	<b>0 445 116 025</b>	0 460 404 977	<b>0 986 440 557</b>	0 460 414 992	<b>0 986 440 522</b>	0 460 485 037	<b>0 986 440 253</b>
0 445 116 029	<b>0 986 435 360</b>	0 460 404 978	<b>0 986 440 568</b>	0 460 414 993	<b>0 986 440 523</b>	0 460 494 039	<b>0 986 440 113</b>
0 445 116 030	<b>0 986 435 360</b>	0 460 404 979	<b>0 986 440 567</b>	0 460 414 996	<b>0 986 440 524</b>	0 460 494 040	<b>0 986 440 113</b>
0 445 116 034	<b>0 986 435 369</b>	0 460 404 982	<b>0 986 440 568</b>	0 460 415 982	<b>0 986 440 525</b>	0 460 494 108	<b>0 986 440 246</b>
0 445 116 046	<b>0 445 116 045</b>	0 460 404 983	<b>0 986 440 558</b>	0 460 415 983	<b>0 986 440 562</b>	0 460 494 152	<b>0 986 440 123</b>
0 445 116 047	<b>0 445 116 022</b>	0 460 404 984	<b>0 986 440 557</b>	0 460 415 984	<b>0 986 440 562</b>	0 460 494 182	<b>0 986 440 125</b>
0 445 117 002	<b>0 986 435 380</b>	0 460 404 985	<b>0 986 440 555</b>	0 460 415 985	<b>0 986 440 571</b>	0 460 494 252	<b>0 986 440 135</b>
0 445 117 004	<b>0 986 435 382</b>	0 460 404 986	<b>0 986 440 554</b>	0 460 415 987	<b>0 986 440 569</b>	0 460 494 267	<b>0 986 440 135</b>
0 445 117 011	<b>0 986 435 384</b>	0 460 404 987	<b>0 986 440 551</b>	0 460 415 988	<b>0 986 440 527</b>	0 460 494 286	<b>0 986 440 247</b>
0 445 117 013	<b>0 986 435 386</b>	0 460 404 989	<b>0 986 440 551</b>	0 460 415 989	<b>0 986 440 563</b>	0 460 494 308	<b>0 986 440 248</b>
0 445 120 002	<b>0 986 435 501</b>	0 460 404 990	<b>0 986 440 568</b>	0 460 415 990	<b>0 986 440 564</b>	0 460 494 314	<b>0 986 440 142</b>
0 445 120 003	<b>0 986 435 524</b>	0 460 404 992	<b>0 986 440 558</b>	0 460 415 991	<b>0 986 440 530</b>	0 460 494 330	<b>0 986 440 143</b>
0 445 120 004	<b>0 986 435 524</b>	0 460 404 993	<b>0 986 440 512</b>	0 460 415 992	<b>0 986 440 531</b>	0 460 494 337	<b>0 986 440 146</b>
0 445 120 007	<b>0 986 435 508</b>	0 460 404 994	<b>0 986 440 555</b>	0 460 415 994	<b>0 986 440 563</b>	0 460 494 346	<b>0 986 440 249</b>
0 445 120 008	<b>0 986 435 502</b>	0 460 404 995	<b>0 986 440 559</b>	0 460 415 995	<b>0 986 440 533</b>	0 460 494 351	<b>0 986 440 149</b>
0 445 120 011	<b>0 986 435 506</b>	0 460 404 998	<b>0 986 440 560</b>	0 460 415 996	<b>0 986 440 565</b>	0 460 494 353	<b>0 986 440 150</b>
0 445 120 012	<b>0 986 435 525</b>	0 460 405 999	<b>0 986 440 550</b>	0 460 415 997	<b>0 986 440 535</b>	0 460 494 356	<b>0 986 440 255</b>
0 445 120 013	<b>0 986 435 525</b>	0 460 406 039	<b>0 986 440 233</b>	0 460 415 998	<b>0 986 440 566</b>	0 460 494 359	<b>0 986 440 205</b>
0 445 120 016	<b>0 986 435 531</b>	0 460 406 040	<b>0 986 440 234</b>	0 460 424 124	<b>0 986 440 062</b>	0 460 494 368	<b>0 986 440 250</b>
0 445 120 017	<b>0 986 435 531</b>	0 460 406 056	<b>0 986 440 015</b>	0 460 424 125	<b>0 986 440 063</b>	0 460 494 369	<b>0 986 440 251</b>
0 445 120 018	<b>0 986 435 503</b>	0 460 406 061	<b>0 986 440 016</b>	0 460 424 136	<b>0 986 440 064</b>	0 460 494 372	<b>0 986 440 152</b>
0 445 120 019	<b>0 986 435 523</b>	0 460 406 063	<b>0 986 440 017</b>	0 460 424 138	<b>0 986 440 228</b>	0 460 494 391	<b>0 986 440 155</b>
0 445 120 020	<b>0 986 435 523</b>	0 460 406 073	<b>0 986 440 235</b>	0 460 424 146	<b>0 986 440 065</b>	0 460 494 393	<b>0 986 440 205</b>
0 445 120 030	<b>0 986 435 517</b>	0 460 406 075	<b>0 986 440 236</b>	0 460 424 147	<b>0 986 440 066</b>	0 460 494 413	<b>0 986 440 250</b>
0 445 120 032	<b>0 986 435 505</b>	0 460 406 079	<b>0 986 440 235</b>	0 460 426 171	<b>0 986 440 076</b>	0 460 494 416	<b>0 986 440 251</b>
0 445 120 036	<b>0 986 435 507</b>	0 460 406 993	<b>0 986 440 515</b>	0 460 484 022	<b>0 986 440 084</b>	0 460 494 417	<b>0 986 440 155</b>
0 445 120 044	<b>0 986 435 527</b>	0 460 406 994	<b>0 986 440 516</b>	0 460 484 031	<b>0 986 440 237</b>	0 460 494 423	<b>0 986 440 156</b>
0 445 120 060	<b>0 986 435 533</b>	0 460 406 995	<b>0 986 440 517</b>	0 460 484 033	<b>0 986 440 238</b>	0 460 494 444	<b>0 986 440 250</b>
0 445 120 061	<b>0 986 435 526</b>	0 460 406 997	<b>0 986 440 518</b>	0 460 484 036	<b>0 460 484 139</b>	0 460 494 445	<b>0 986 440 251</b>
0 445 120 064	<b>0 986 435 529</b>	0 460 413 001	<b>0 986 440 021</b>	0 460 484 037	<b>0 460 484 140</b>	0 460 494 455	<b>0 986 440 161</b>
0 445 120 075	<b>0 986 435 530</b>	0 460 414 008	<b>0 986 440 023</b>	0 460 484 039	<b>0 460 484 141</b>	0 460 494 466	<b>0 986 440 163</b>
0 445 120 100	<b>0 986 435 528</b>	0 460 414 013	<b>0 986 440 024</b>	0 460 484 040	<b>0 986 440 240</b>	0 460 494 995	<b>0 986 440 538</b>
0 445 120 113	<b>0 986 435 503</b>	0 460 414 054	<b>0 986 440 027</b>	0 460 484 046	<b>0 986 440 239</b>	0 470 004 002	<b>0 986 444 519</b>
0 445 120 136	<b>0 986 435 529</b>	0 460 414 067	<b>0 986 440 028</b>	0 460 484 064	<b>0 986 440 094</b>	0 470 004 003	<b>0 986 444 500</b>
0 445 120 210	<b>0 986 435 503</b>	0 460 414 078	<b>0 986 440 032</b>	0 460 484 071	<b>0 986 440 240</b>	0 470 004 004	<b>0 986 444 522</b>
0 445 120 212	<b>0 986 435 508</b>	0 460 414 081	<b>0 986 440 033</b>	0 460 484 101	<b>0 986 440 240</b>	0 470 004 004	<b>0 986 444 523</b>
0 445 120 217	<b>0 986 435 526</b>	0 460 414 086	<b>0 986 440 035</b>	0 460 484 102	<b>0 986 440 237</b>	0 470 004 005	<b>0 986 444 503</b>
0 445 120 218	<b>0 986 435 517</b>	0 460 414 098	<b>0 986 440 038</b>	0 460 484 127	<b>0 986 440 240</b>	0 470 004 006	<b>0 986 444 521</b>
0 445 120 219	<b>0 986 435 528</b>	0 460 414 108	<b>0 986 440 040</b>	0 460 484 128	<b>0 986 440 241</b>	0 470 004 007	<b>0 986 444 519</b>
0 445 120 250	<b>0 986 435 533</b>	0 460 414 109	<b>0 986 440 041</b>	0 460 484 143	<b>0 986 440 107</b>	0 470 004 008	<b>0 986 444 521</b>
0 455 010 088	<b>0 445 010 113</b>	0 460 414 112	<b>0 986 440 042</b>	0 460 484 150	<b>0 986 440 225</b>	0 470 004 009	<b>0 986 444 520</b>
0 460 404 074	<b>0 986 440 002</b>	0 460 414 113	<b>0 986 440 043</b>	0 460 484 152	<b>0 986 440 226</b>	0 470 004 012	<b>0 986 444 522</b>
0 460 404 959	<b>0 986 440 557</b>	0 460 414 119	<b>0 986 440 046</b>	0 460 484 160	<b>0 986 440 240</b>	0 470 004 012	<b>0 986 444 523</b>

0 470 004 013	<b>0 470 004 013</b>	0 470 504 224	<b>0 986 444 037</b>	0 986 430 010	<b>0 986 430 010</b>	0 986 430 188	<b>0 986 430 188</b>
0 470 004 013	<b>0 986 444 520</b>	0 470 504 225	<b>0 986 444 037</b>	0 986 430 015	<b>0 986 430 015</b>	0 986 430 189	<b>0 986 430 189</b>
0 470 004 018	<b>0 986 444 507</b>	0 470 504 226	<b>0 986 444 030</b>	0 986 430 015	<b>0 986 430 028</b>	0 986 430 190	<b>0 986 430 190</b>
0 470 004 019	<b>0 986 444 508</b>	0 470 504 227	<b>0 986 444 036</b>	0 986 430 020	<b>0 986 430 020</b>	0 986 430 196	<b>0 986 430 196</b>
0 470 006 001	<b>0 986 444 511</b>	0 470 506 002	<b>0 986 444 067</b>	0 986 430 022	<b>0 986 430 022</b>	0 986 430 197	<b>0 986 430 197</b>
0 470 006 005	<b>0 986 444 509</b>	0 470 506 003	<b>0 986 444 009</b>	0 986 430 025	<b>0 986 430 025</b>	0 986 430 198	<b>0 986 430 198</b>
0 470 006 006	<b>0 986 444 510</b>	0 470 506 003	<b>0 986 444 032</b>	0 986 430 026	<b>0 986 430 026</b>	0 986 430 203	<b>0 986 430 203</b>
0 470 006 007	<b>0 986 444 511</b>	0 470 506 005	<b>0 986 444 007</b>	0 986 430 028	<b>0 986 430 028</b>	0 986 430 205	<b>0 986 430 205</b>
0 470 504 002	<b>0 986 444 001</b>	0 470 506 005	<b>0 986 444 031</b>	0 986 430 030	<b>0 986 430 030</b>	0 986 430 206	<b>0 986 430 206</b>
0 470 504 003	<b>0 986 444 002</b>	0 470 506 006	<b>0 986 444 068</b>	0 986 430 031	<b>0 986 430 031</b>	0 986 430 208	<b>0 986 430 208</b>
0 470 504 004	<b>0 986 444 003</b>	0 470 506 009	<b>0 986 444 010</b>	0 986 430 032	<b>0 986 430 032</b>	0 986 430 210	<b>0 986 430 210</b>
0 470 504 005	<b>0 986 444 004</b>	0 470 506 010	<b>0 986 444 070</b>	0 986 430 033	<b>0 986 430 033</b>	0 986 430 211	<b>0 986 430 211</b>
0 470 504 009	<b>0 986 444 005</b>	0 470 506 011	<b>0 986 444 007</b>	0 986 430 034	<b>0 986 430 034</b>	0 986 430 212	<b>0 986 430 212</b>
0 470 504 010	<b>0 986 444 078</b>	0 470 506 011	<b>0 986 444 031</b>	0 986 430 038	<b>0 986 430 038</b>	0 986 430 213	<b>0 986 430 213</b>
0 470 504 011	<b>0 986 444 012</b>	0 470 506 012	<b>0 986 444 009</b>	0 986 430 039	<b>0 986 430 039</b>	0 986 430 214	<b>0 986 430 214</b>
0 470 504 012	<b>0 986 444 013</b>	0 470 506 012	<b>0 986 444 032</b>	0 986 430 042	<b>0 986 430 042</b>	0 986 430 221	<b>0 986 430 221</b>
0 470 504 015	<b>0 986 444 014</b>	0 470 506 014	<b>0 986 444 017</b>	0 986 430 045	<b>0 986 430 045</b>	0 986 430 225	<b>0 986 430 225</b>
0 470 504 016	<b>0 986 444 021</b>	0 470 506 015	<b>0 986 444 007</b>	0 986 430 046	<b>0 986 430 046</b>	0 986 430 228	<b>0 986 430 228</b>
0 470 504 017	<b>0 986 444 090</b>	0 470 506 015	<b>0 986 444 018</b>	0 986 430 053	<b>0 986 430 053</b>	0 986 430 234	<b>0 986 430 234</b>
0 470 504 018	<b>0 986 444 078</b>	0 470 506 015	<b>0 986 444 031</b>	0 986 430 055	<b>0 986 430 055</b>	0 986 430 235	<b>0 986 430 235</b>
0 470 504 020	<b>0 986 444 019</b>	0 470 506 016	<b>0 986 444 071</b>	0 986 430 056	<b>0 986 430 056</b>	0 986 430 240	<b>0 986 430 240</b>
0 470 504 021	<b>0 986 444 079</b>	0 470 506 017	<b>0 470 506 017</b>	0 986 430 064	<b>0 986 430 064</b>	0 986 430 241	<b>0 986 430 241</b>
0 470 504 022	<b>0 986 444 081</b>	0 470 506 017	<b>0 986 444 082</b>	0 986 430 067	<b>0 986 430 067</b>	0 986 430 243	<b>0 986 430 243</b>
0 470 504 023	<b>0 986 444 056</b>	0 470 506 018	<b>0 986 444 085</b>	0 986 430 074	<b>0 986 430 074</b>	0 986 430 244	<b>0 986 430 244</b>
0 470 504 024	<b>0 986 444 079</b>	0 470 506 019	<b>0 986 444 077</b>	0 986 430 080	<b>0 986 430 080</b>	0 986 430 245	<b>0 986 430 245</b>
0 470 504 025	<b>0 986 444 035</b>	0 470 506 021	<b>0 986 444 017</b>	0 986 430 081	<b>0 986 430 081</b>	0 986 430 246	<b>0 986 430 246</b>
0 470 504 028	<b>0 986 444 057</b>	0 470 506 022	<b>0 986 444 007</b>	0 986 430 089	<b>0 986 430 089</b>	0 986 430 247	<b>0 986 430 247</b>
0 470 504 035	<b>0 986 444 075</b>	0 470 506 022	<b>0 986 444 031</b>	0 986 430 090	<b>0 986 430 090</b>	0 986 430 249	<b>0 986 430 249</b>
0 470 504 036	<b>0 986 444 075</b>	0 470 506 023	<b>0 986 444 061</b>	0 986 430 091	<b>0 986 430 091</b>	0 986 430 250	<b>0 986 430 250</b>
0 470 504 040	<b>0 986 444 076</b>	0 470 506 024	<b>0 986 444 073</b>	0 986 430 092	<b>0 986 430 092</b>	0 986 430 252	<b>0 986 430 252</b>
0 470 504 041	<b>0 986 444 076</b>	0 470 506 025	<b>0 986 444 080</b>	0 986 430 093	<b>0 986 430 093</b>	0 986 430 253	<b>0 986 430 253</b>
0 470 504 042	<b>0 986 444 058</b>	0 470 506 026	<b>0 986 444 009</b>	0 986 430 094	<b>0 986 430 094</b>	0 986 430 256	<b>0 986 430 256</b>
0 470 504 201	<b>0 986 444 045</b>	0 470 506 026	<b>0 986 444 032</b>	0 986 430 095	<b>0 986 430 095</b>	0 986 430 257	<b>0 986 430 257</b>
0 470 504 202	<b>0 986 444 028</b>	0 470 506 027	<b>0 986 444 022</b>	0 986 430 120	<b>0 986 430 120</b>	0 986 430 261	<b>0 986 430 261</b>
0 470 504 203	<b>0 986 444 036</b>	0 470 506 028	<b>0 986 444 023</b>	0 986 430 124	<b>0 986 430 124</b>	0 986 430 263	<b>0 986 430 263</b>
0 470 504 204	<b>0 986 444 029</b>	0 470 506 029	<b>0 986 444 024</b>	0 986 430 133	<b>0 986 430 133</b>	0 986 430 264	<b>0 986 430 264</b>
0 470 504 205	<b>0 986 444 028</b>	0 470 506 030	<b>0 986 444 072</b>	0 986 430 141	<b>0 986 430 141</b>	0 986 430 265	<b>0 986 430 265</b>
0 470 504 206	<b>0 986 444 045</b>	0 470 506 030	<b>0 986 444 073</b>	0 986 430 144	<b>0 986 430 144</b>	0 986 430 267	<b>0 986 430 267</b>
0 470 504 207	<b>0 986 444 030</b>	0 470 506 031	<b>0 986 444 086</b>	0 986 430 151	<b>0 986 430 151</b>	0 986 430 268	<b>0 986 430 268</b>
0 470 504 208	<b>0 986 444 046</b>	0 470 506 032	<b>0 986 444 087</b>	0 986 430 159	<b>0 986 430 159</b>	0 986 430 269	<b>0 986 430 269</b>
0 470 504 209	<b>0 986 444 028</b>	0 470 506 033	<b>0 986 444 073</b>	0 986 430 162	<b>0 986 430 162</b>	0 986 430 270	<b>0 986 430 270</b>
0 470 504 210	<b>0 986 444 029</b>	0 470 506 034	<b>0 986 444 052</b>	0 986 430 163	<b>0 986 430 163</b>	0 986 430 274	<b>0 986 430 274</b>
0 470 504 211	<b>0 986 444 037</b>	0 470 506 037	<b>0 986 444 084</b>	0 986 430 164	<b>0 986 430 164</b>	0 986 430 301	<b>0 986 430 301</b>
0 470 504 212	<b>0 986 444 046</b>	0 470 506 038	<b>0 986 444 083</b>	0 986 430 165	<b>0 986 430 165</b>	0 986 430 302	<b>0 986 430 302</b>
0 470 504 213	<b>0 986 444 037</b>	0 470 506 039	<b>0 986 444 062</b>	0 986 430 166	<b>0 986 430 166</b>	0 986 430 304	<b>0 986 430 304</b>
0 470 504 214	<b>0 986 444 030</b>	0 470 506 040	<b>0 986 444 053</b>	0 986 430 167	<b>0 986 430 167</b>	0 986 430 307	<b>0 986 430 307</b>
0 470 504 215	<b>0 986 444 028</b>	0 470 506 041	<b>0 986 444 054</b>	0 986 430 168	<b>0 986 430 168</b>	0 986 430 311	<b>0 986 430 311</b>
0 470 504 216	<b>0 986 444 030</b>	0 470 506 043	<b>0 986 444 088</b>	0 986 430 169	<b>0 986 430 169</b>	0 986 430 312	<b>0 986 430 312</b>
0 470 504 217	<b>0 986 444 030</b>	0 470 506 044	<b>0 986 444 089</b>	0 986 430 171	<b>0 986 430 171</b>	0 986 430 313	<b>0 986 430 313</b>
0 470 504 218	<b>0 986 444 036</b>	0 470 506 045	<b>0 986 444 091</b>	0 986 430 172	<b>0 986 430 172</b>	0 986 430 321	<b>0 986 430 321</b>
0 470 504 219	<b>0 986 444 037</b>	0 470 506 046	<b>0 986 444 074</b>	0 986 430 173	<b>0 986 430 173</b>	0 986 430 325	<b>0 986 430 325</b>
0 470 504 220	<b>0 986 444 030</b>	0 470 506 047	<b>0 986 444 065</b>	0 986 430 176	<b>0 986 430 176</b>	0 986 430 326	<b>0 986 430 326</b>
0 470 504 221	<b>0 986 444 037</b>	0 470 506 048	<b>0 986 444 066</b>	0 986 430 178	<b>0 986 430 178</b>	0 986 430 327	<b>0 986 430 327</b>
0 470 504 222	<b>0 986 444 036</b>	0 986 430 000	<b>0 986 430 000</b>	0 986 430 184	<b>0 986 430 184</b>	0 986 430 329	<b>0 986 430 329</b>
0 470 504 223	<b>0 986 444 036</b>	0 986 430 002	<b>0 986 430 002</b>	0 986 430 187	<b>0 986 430 187</b>	0 986 430 330	<b>0 986 430 330</b>





0986 435 357	<b>0986 435 357</b>	0986 437 092	<b>0986 437 093</b>	0986 437 412	<b>0986 437 412</b>	0986 440 107	<b>0986 440 107</b>
0986 435 358	<b>0986 435 358</b>	0986 437 093	<b>0986 437 093</b>	0986 437 413	<b>0986 437 414</b>	0986 440 108	<b>0986 440 242</b>
0986 435 359	<b>0986 435 359</b>	0986 437 101	<b>0986 437 101</b>	0986 437 414	<b>0986 437 414</b>	0986 440 109	<b>0986 440 243</b>
0986 435 360	<b>0986 435 360</b>	0986 437 102	<b>0986 437 102</b>	0986 437 415	<b>0986 437 416</b>	0986 440 110	<b>0986 440 244</b>
0986 435 362	<b>0986 435 362</b>	0986 437 103	<b>0986 437 103</b>	0986 437 416	<b>0986 437 416</b>	0986 440 113	<b>0986 440 113</b>
0986 435 363	<b>0986 435 363</b>	0986 437 104	<b>0986 437 104</b>	0986 437 417	<b>0986 437 418</b>	0986 440 118	<b>0986 440 246</b>
0986 435 364	<b>0986 435 364</b>	0986 437 106	<b>0986 437 106</b>	0986 437 418	<b>0986 437 418</b>	0986 440 123	<b>0986 440 123</b>
0986 435 501	<b>0986 435 501</b>	0986 437 301	<b>0986 437 301</b>	0986 437 419	<b>0986 437 420</b>	0986 440 125	<b>0986 440 125</b>
0986 435 502	<b>0986 435 502</b>	0986 437 302	<b>0986 437 302</b>	0986 437 420	<b>0986 437 420</b>	0986 440 135	<b>0986 440 135</b>
0986 435 503	<b>0986 435 503</b>	0986 437 303	<b>0986 437 303</b>	0986 437 501	<b>0986 437 501</b>	0986 440 139	<b>0986 440 247</b>
0986 435 505	<b>0986 435 505</b>	0986 437 305	<b>0986 437 360</b>	0986 437 502	<b>0986 437 502</b>	0986 440 141	<b>0986 440 248</b>
0986 435 506	<b>0986 435 506</b>	0986 437 306	<b>0986 437 364</b>	0986 44D 002	<b>0986 44D 002</b>	0986 440 142	<b>0986 440 142</b>
0986 435 507	<b>0986 435 507</b>	0986 437 308	<b>0986 437 308</b>	0986 44D 102	<b>0986 44D 102</b>	0986 440 143	<b>0986 440 143</b>
0986 435 508	<b>0986 435 508</b>	0986 437 311	<b>0986 437 364</b>	0986 440 002	<b>0986 440 002</b>	0986 440 146	<b>0986 440 146</b>
0986 435 515	<b>0986 435 515</b>	0986 437 312	<b>0986 437 312</b>	0986 440 011	<b>0986 440 233</b>	0986 440 148	<b>0986 440 249</b>
0986 435 517	<b>0986 435 517</b>	0986 437 313	<b>0986 437 313</b>	0986 440 012	<b>0986 440 234</b>	0986 440 149	<b>0986 440 149</b>
0986 435 523	<b>0986 435 523</b>	0986 437 314	<b>0986 437 314</b>	0986 440 015	<b>0986 440 015</b>	0986 440 150	<b>0986 440 150</b>
0986 435 524	<b>0986 435 524</b>	0986 437 315	<b>0986 437 315</b>	0986 440 016	<b>0986 440 016</b>	0986 440 152	<b>0986 440 152</b>
0986 435 525	<b>0986 435 525</b>	0986 437 316	<b>0986 437 316</b>	0986 440 017	<b>0986 440 017</b>	0986 440 155	<b>0986 440 155</b>
0986 435 526	<b>0986 435 526</b>	0986 437 317	<b>0986 437 317</b>	0986 440 018	<b>0986 440 235</b>	0986 440 156	<b>0986 440 156</b>
0986 435 527	<b>0986 435 527</b>	0986 437 318	<b>0986 437 318</b>	0986 440 019	<b>0986 440 236</b>	0986 440 161	<b>0986 440 161</b>
0986 435 528	<b>0986 435 528</b>	0986 437 322	<b>0445 010 089</b>	0986 440 021	<b>0986 440 021</b>	0986 440 163	<b>0986 440 163</b>
0986 435 529	<b>0986 435 529</b>	0986 437 322	<b>0986 437 322</b>	0986 440 023	<b>0986 440 023</b>	0986 440 205	<b>0986 440 205</b>
0986 435 530	<b>0986 435 530</b>	0986 437 323	<b>0986 437 323</b>	0986 440 024	<b>0986 440 024</b>	0986 440 206	<b>0986 440 250</b>
0986 435 531	<b>0986 435 531</b>	0986 437 324	<b>0986 437 367</b>	0986 440 027	<b>0986 440 027</b>	0986 440 207	<b>0986 440 251</b>
0986 437 001	<b>0986 437 001</b>	0986 437 325	<b>0986 437 325</b>	0986 440 028	<b>0986 440 028</b>	0986 440 208	<b>0986 440 252</b>
0986 437 002	<b>0986 437 002</b>	0986 437 326	<b>0986 437 362</b>	0986 440 032	<b>0986 440 032</b>	0986 440 209	<b>0986 440 253</b>
0986 437 003	<b>0986 437 100</b>	0986 437 327	<b>0986 437 363</b>	0986 440 033	<b>0986 440 033</b>	0986 440 214	<b>0986 440 254</b>
0986 437 004	<b>0986 437 004</b>	0986 437 328	<b>0986 437 364</b>	0986 440 035	<b>0986 440 035</b>	0986 440 215	<b>0986 440 255</b>
0986 437 005	<b>0986 437 005</b>	0986 437 329	<b>0986 437 365</b>	0986 440 038	<b>0986 440 038</b>	0986 440 217	<b>0986 440 217</b>
0986 437 006	<b>0986 437 006</b>	0986 437 339	<b>0986 437 366</b>	0986 440 040	<b>0986 440 040</b>	0986 440 219	<b>0986 440 219</b>
0986 437 007	<b>0986 437 101</b>	0986 437 341	<b>0986 437 341</b>	0986 440 041	<b>0986 440 041</b>	0986 440 225	<b>0986 440 225</b>
0986 437 008	<b>0986 437 102</b>	0986 437 342	<b>0986 437 342</b>	0986 440 042	<b>0986 440 042</b>	0986 440 226	<b>0986 440 226</b>
0986 437 009	<b>0986 437 009</b>	0986 437 343	<b>0986 437 344</b>	0986 440 043	<b>0986 440 043</b>	0986 440 228	<b>0986 440 228</b>
0986 437 010	<b>0986 437 010</b>	0986 437 344	<b>0986 437 344</b>	0986 440 046	<b>0986 440 046</b>	0986 440 229	<b>0986 440 256</b>
0986 437 011	<b>0986 437 103</b>	0986 437 345	<b>0986 437 346</b>	0986 440 048	<b>0986 440 048</b>	0986 440 233	<b>0986 440 233</b>
0986 437 012	<b>0986 437 012</b>	0986 437 346	<b>0986 437 346</b>	0986 440 051	<b>0986 440 051</b>	0986 440 234	<b>0986 440 234</b>
0986 437 013	<b>0986 437 104</b>	0986 437 347	<b>0986 437 348</b>	0986 440 052	<b>0986 440 052</b>	0986 440 235	<b>0986 440 235</b>
0986 437 014	<b>0986 437 105</b>	0986 437 348	<b>0986 437 348</b>	0986 440 053	<b>0986 440 053</b>	0986 440 236	<b>0986 440 236</b>
0986 437 015	<b>0986 437 015</b>	0986 437 349	<b>0986 437 316</b>	0986 440 054	<b>0986 440 054</b>	0986 440 237	<b>0986 440 237</b>
0986 437 016	<b>0986 437 106</b>	0986 437 350	<b>0986 437 350</b>	0986 440 055	<b>0986 440 055</b>	0986 440 238	<b>0986 440 238</b>
0986 437 017	<b>0986 437 017</b>	0986 437 351	<b>0986 437 351</b>	0986 440 056	<b>0986 440 056</b>	0986 440 239	<b>0986 440 239</b>
0986 437 018	<b>0986 437 018</b>	0986 437 352	<b>0986 437 352</b>	0986 440 062	<b>0986 440 062</b>	0986 440 240	<b>0986 440 240</b>
0986 437 019	<b>0986 437 019</b>	0986 437 353	<b>0986 437 353</b>	0986 440 063	<b>0986 440 063</b>	0986 440 241	<b>0986 440 241</b>
0986 437 020	<b>0986 437 020</b>	0986 437 360	<b>0986 437 360</b>	0986 440 064	<b>0986 440 064</b>	0986 440 242	<b>0986 440 242</b>
0986 437 021	<b>0986 437 021</b>	0986 437 362	<b>0986 437 362</b>	0986 440 065	<b>0986 440 065</b>	0986 440 243	<b>0986 440 243</b>
0986 437 022	<b>0986 437 022</b>	0986 437 363	<b>0986 437 363</b>	0986 440 066	<b>0986 440 066</b>	0986 440 244	<b>0986 440 244</b>
0986 437 023	<b>0986 437 023</b>	0986 437 364	<b>0986 437 364</b>	0986 440 076	<b>0986 440 076</b>	0986 440 246	<b>0986 440 246</b>
0986 437 024	<b>0986 437 024</b>	0986 437 365	<b>0986 437 365</b>	0986 440 084	<b>0986 440 084</b>	0986 440 247	<b>0986 440 247</b>
0986 437 025	<b>0986 437 025</b>	0986 437 366	<b>0986 437 366</b>	0986 440 086	<b>0986 440 237</b>	0986 440 248	<b>0986 440 248</b>
0986 437 028	<b>0986 437 028</b>	0986 437 367	<b>0986 437 367</b>	0986 440 087	<b>0986 440 238</b>	0986 440 249	<b>0986 440 249</b>
0986 437 080	<b>0986 437 080</b>	0986 437 407	<b>0986 437 408</b>	0986 440 091	<b>0986 440 239</b>	0986 440 251	<b>0986 440 251</b>
0986 437 081	<b>0986 437 081</b>	0986 437 408	<b>0986 437 408</b>	0986 440 094	<b>0986 440 094</b>	0986 440 252	<b>0986 440 252</b>
0986 437 085	<b>0986 437 085</b>	0986 437 409	<b>0986 437 410</b>	0986 440 103	<b>0986 440 240</b>	0986 440 253	<b>0986 440 253</b>
0986 437 086	<b>0986 437 086</b>	0986 437 411	<b>0986 437 412</b>	0986 440 104	<b>0986 440 241</b>	0986 440 254	<b>0986 440 254</b>



## ◀ BOSCH-EXCHANGE

0986 440 255	<b>0986 440 255</b>	0986 440 562	<b>0986 440 562</b>	0986 441 515	<b>0986 441 565</b>	0986 444 010	<b>0986 444 010</b>
0986 440 256	<b>0986 440 256</b>	0986 440 563	<b>0986 440 563</b>	0986 441 516	<b>0986 441 566</b>	0986 444 011	<b>0986 444 078</b>
0986 440 501	<b>0986 440 551</b>	0986 440 564	<b>0986 440 564</b>	0986 441 517	<b>0986 441 567</b>	0986 444 012	<b>0986 444 012</b>
0986 440 502	<b>0986 440 552</b>	0986 440 565	<b>0986 440 565</b>	0986 441 518	<b>0986 441 568</b>	0986 444 013	<b>0986 444 013</b>
0986 440 503	<b>0986 440 553</b>	0986 440 566	<b>0986 440 566</b>	0986 441 519	<b>0986 441 569</b>	0986 444 014	<b>0986 444 014</b>
0986 440 504	<b>0986 440 554</b>	0986 440 567	<b>0986 440 567</b>	0986 441 520	<b>0986 441 570</b>	0986 444 015	<b>0986 444 070</b>
0986 440 505	<b>0986 440 555</b>	0986 440 568	<b>0986 440 568</b>	0986 441 521	<b>0986 441 571</b>	0986 444 016	<b>0986 444 071</b>
0986 440 506	<b>0986 440 556</b>	0986 440 569	<b>0986 440 569</b>	0986 441 522	<b>0986 441 572</b>	0986 444 017	<b>0986 444 017</b>
0986 440 507	<b>0986 440 507</b>	0986 440 570	<b>0986 440 570</b>	0986 441 523	<b>0986 441 573</b>	0986 444 018	<b>0986 444 018</b>
0986 440 508	<b>0986 440 508</b>	0986 440 571	<b>0986 440 571</b>	0986 441 524	<b>0986 441 574</b>	0986 444 019	<b>0986 444 019</b>
0986 440 509	<b>0986 440 557</b>	0986 441 001	<b>0986 441 101</b>	0986 441 525	<b>0986 441 575</b>	0986 444 020	<b>0986 444 079</b>
0986 440 510	<b>0986 440 568</b>	0986 441 002	<b>0986 441 102</b>	0986 441 526	<b>0986 441 576</b>	0986 444 021	<b>0986 444 021</b>
0986 440 511	<b>0986 440 558</b>	0986 441 003	<b>0986 441 103</b>	0986 441 527	<b>0986 441 577</b>	0986 444 022	<b>0986 444 022</b>
0986 440 512	<b>0986 440 512</b>	0986 441 004	<b>0414 701 004</b>	0986 441 528	<b>0986 441 578</b>	0986 444 023	<b>0986 444 023</b>
0986 440 513	<b>0986 440 559</b>	0986 441 004	<b>0986 441 004</b>	0986 441 529	<b>0986 441 579</b>	0986 444 024	<b>0986 444 024</b>
0986 440 514	<b>0986 440 560</b>	0986 441 006	<b>0986 441 006</b>	0986 441 530	<b>0986 441 580</b>	0986 444 026	<b>0986 444 072</b>
0986 440 515	<b>0986 440 515</b>	0986 441 007	<b>0986 441 107</b>	0986 441 551	<b>0986 441 551</b>	0986 444 027	<b>0986 444 073</b>
0986 440 516	<b>0986 440 516</b>	0986 441 008	<b>0986 441 108</b>	0986 441 552	<b>0986 441 552</b>	0986 444 028	<b>0986 444 028</b>
0986 440 517	<b>0986 440 517</b>	0986 441 009	<b>0986 441 109</b>	0986 441 553	<b>0986 441 553</b>	0986 444 029	<b>0986 444 029</b>
0986 440 518	<b>0986 440 518</b>	0986 441 010	<b>0986 441 110</b>	0986 441 554	<b>0986 441 554</b>	0986 444 030	<b>0986 444 030</b>
0986 440 519	<b>0986 440 561</b>	0986 441 011	<b>0986 441 111</b>	0986 441 555	<b>0986 441 555</b>	0986 444 031	<b>0986 444 031</b>
0986 440 520	<b>0986 440 520</b>	0986 441 012	<b>0986 441 112</b>	0986 441 556	<b>0986 441 556</b>	0986 444 032	<b>0986 444 032</b>
0986 440 522	<b>0986 440 522</b>	0986 441 013	<b>0986 441 113</b>	0986 441 557	<b>0986 441 557</b>	0986 444 033	<b>0986 444 074</b>
0986 440 523	<b>0986 440 523</b>	0986 441 014	<b>0986 441 114</b>	0986 441 559	<b>0986 441 559</b>	0986 444 034	<b>0986 444 075</b>
0986 440 524	<b>0986 440 524</b>	0986 441 015	<b>0986 441 115</b>	0986 441 560	<b>0986 441 560</b>	0986 444 035	<b>0986 444 035</b>
0986 440 525	<b>0986 440 525</b>	0986 441 016	<b>0986 441 116</b>	0986 441 561	<b>0986 441 561</b>	0986 444 036	<b>0986 444 036</b>
0986 440 526	<b>0986 440 562</b>	0986 441 025	<b>0986 441 025</b>	0986 441 562	<b>0986 441 562</b>	0986 444 037	<b>0986 444 037</b>
0986 440 527	<b>0986 440 527</b>	0986 441 026	<b>0986 441 026</b>	0986 441 563	<b>0986 441 563</b>	0986 444 038	<b>0986 444 076</b>
0986 440 528	<b>0986 440 563</b>	0986 441 027	<b>0986 441 027</b>	0986 441 564	<b>0986 441 564</b>	0986 444 039	<b>0986 444 077</b>
0986 440 529	<b>0986 440 564</b>	0986 441 101	<b>0986 441 101</b>	0986 441 565	<b>0986 441 565</b>	0986 444 040	<b>0986 444 080</b>
0986 440 530	<b>0986 440 530</b>	0986 441 102	<b>0986 441 102</b>	0986 441 566	<b>0986 441 566</b>	0986 444 041	<b>0986 444 081</b>
0986 440 531	<b>0986 440 531</b>	0986 441 103	<b>0986 441 103</b>	0986 441 567	<b>0986 441 567</b>	0986 444 042	<b>0470 506 017</b>
0986 440 532	<b>0986 440 563</b>	0986 441 107	<b>0986 441 107</b>	0986 441 568	<b>0986 441 568</b>	0986 444 042	<b>0986 444 082</b>
0986 440 533	<b>0986 440 533</b>	0986 441 108	<b>0986 441 108</b>	0986 441 569	<b>0986 441 569</b>	0986 444 043	<b>0986 444 083</b>
0986 440 534	<b>0986 440 565</b>	0986 441 109	<b>0986 441 109</b>	0986 441 570	<b>0986 441 570</b>	0986 444 044	<b>0986 444 084</b>
0986 440 535	<b>0986 440 535</b>	0986 441 110	<b>0986 441 110</b>	0986 441 571	<b>0986 441 571</b>	0986 444 045	<b>0986 444 045</b>
0986 440 536	<b>0986 440 566</b>	0986 441 111	<b>0986 441 111</b>	0986 441 572	<b>0986 441 572</b>	0986 444 046	<b>0986 444 046</b>
0986 440 538	<b>0986 440 538</b>	0986 441 112	<b>0986 441 112</b>	0986 441 573	<b>0986 441 573</b>	0986 444 047	<b>0986 444 085</b>
0986 440 540	<b>0986 440 567</b>	0986 441 113	<b>0986 441 113</b>	0986 441 574	<b>0986 441 574</b>	0986 444 048	<b>0986 444 086</b>
0986 440 543	<b>0986 440 568</b>	0986 441 114	<b>0986 441 114</b>	0986 441 575	<b>0986 441 575</b>	0986 444 049	<b>0986 444 087</b>
0986 440 544	<b>0986 440 569</b>	0986 441 115	<b>0986 441 115</b>	0986 441 576	<b>0986 441 576</b>	0986 444 050	<b>0986 444 088</b>
0986 440 547	<b>0986 440 570</b>	0986 441 116	<b>0986 441 116</b>	0986 441 577	<b>0986 441 577</b>	0986 444 051	<b>0986 444 089</b>
0986 440 549	<b>0986 440 571</b>	0986 441 501	<b>0986 441 551</b>	0986 441 578	<b>0986 441 578</b>	0986 444 052	<b>0986 444 052</b>
0986 440 550	<b>0986 440 550</b>	0986 441 502	<b>0986 441 552</b>	0986 441 579	<b>0986 441 579</b>	0986 444 053	<b>0986 444 053</b>
0986 440 551	<b>0986 440 551</b>	0986 441 503	<b>0986 441 553</b>	0986 441 580	<b>0986 441 580</b>	0986 444 054	<b>0986 444 054</b>
0986 440 552	<b>0986 440 552</b>	0986 441 504	<b>0986 441 554</b>	0986 444 001	<b>0986 444 001</b>	0986 444 055	<b>0986 444 090</b>
0986 440 553	<b>0986 440 553</b>	0986 441 505	<b>0986 441 555</b>	0986 444 002	<b>0986 444 002</b>	0986 444 056	<b>0986 444 056</b>
0986 440 554	<b>0986 440 554</b>	0986 441 506	<b>0986 441 556</b>	0986 444 003	<b>0986 444 003</b>	0986 444 057	<b>0986 444 057</b>
0986 440 555	<b>0986 440 555</b>	0986 441 507	<b>0986 441 557</b>	0986 444 004	<b>0986 444 004</b>	0986 444 058	<b>0986 444 058</b>
0986 440 556	<b>0986 440 556</b>	0986 441 509	<b>0986 441 559</b>	0986 444 005	<b>0986 444 005</b>	0986 444 061	<b>0986 444 061</b>
0986 440 557	<b>0986 440 557</b>	0986 441 510	<b>0986 441 560</b>	0986 444 006	<b>0986 444 067</b>	0986 444 062	<b>0986 444 062</b>
0986 440 558	<b>0986 440 558</b>	0986 441 511	<b>0986 441 561</b>	0986 444 007	<b>0986 444 007</b>	0986 444 064	<b>0986 444 091</b>
0986 440 559	<b>0986 440 559</b>	0986 441 512	<b>0986 441 562</b>	0986 444 008	<b>0986 444 068</b>	0986 444 065	<b>0986 444 065</b>
0986 440 560	<b>0986 440 560</b>	0986 441 513	<b>0986 441 563</b>	0986 444 009	<b>0470 506 029</b>	0986 444 066	<b>0986 444 066</b>
0986 440 561	<b>0986 440 561</b>	0986 441 514	<b>0986 441 564</b>	0986 444 009	<b>0986 444 009</b>	0986 444 067	<b>0986 444 067</b>







1920 W2	0 460 494 344	1980 J3	0 445 110 259	96 011 913	0 986 430 028	96 282 404	0 986 435 014
1920 X3	0 460 484 070	1980 J3	0 986 435 126	96 014 904	0 460 494 223	96 288 220	0 432 217 310
1920 OC	0 460 484 078	1980 J8	0 445 115 025	96 036 729	0 432 217 152	96 298 937	0 460 484 148
1920 OH	0 460 484 070	1980 J8	0 986 435 351	96 036 735	0 432 217 193	96 313 069	0 460 484 138
1920 OK	0 460 494 367	1980 K2	0 445 110 252	96 069 910	0 432 217 218	96 318 692	0 460 484 146
1920 OM	0 460 494 382	1980 K2	0 986 435 143	96 069 910	0 432 217 248	96 320 137	0 445 010 010
1920 1T	0 460 494 384	1980 K7	0 445 110 281	96 069 910	0 986 430 240	96 320 137	0 986 437 005
1920 1W	0 460 494 430	1980 K7	0 986 435 150	96 069 910	0 986 430 244	96 321 644	0 460 494 459
1920 1X	0 460 484 111	1980 K9	0 445 110 297	96 076 130	0 460 494 278	96 328 436	0 432 217 310
1920 2N	0 460 494 423	1980 K9	0 986 435 150	96 115 902	0 460 494 313	96 328 878	0 460 484 137
1920 2N	0 986 440 156	1980 L1	0 445 110 311	96 122 780	0 432 217 248	96 328 879	0 460 494 455
1920 2P	0 460 494 384	1980 L1	0 986 435 146	96 122 780	0 986 430 244	96 328 879	0 986 440 161
1920 2T	0 460 494 411	1980 S5	0 445 110 340	96 129 622	0 460 494 310	96 331 365	0 460 494 459
1920 21	0 460 494 079	1980 18	0 432 217 270	96 139 285	0 460 484 078	96 331 694	0 460 494 467
1920 3T	0 986 440 051	1980 23	0 432 217 286	96 151 697	0 432 217 268	96 352 463	0 445 110 057
1920 33	0 460 494 121	1980 27	0 432 193 728	96 151 697	0 986 430 381	96 352 463	0 986 435 093
1920 4E	0 460 484 109	1980 58	0 986 435 003	96 154 507	0 460 404 993	96 364 040	0 445 110 036
1920 4Z	0 460 484 138	1980 60	0 432 217 301	96 154 507	0 986 440 512	96 364 040	0 986 435 014
1920 5R	0 460 494 446	1980 71	0 445 110 008	96 154 509	0 986 440 146	96 372 779	0 445 110 036
1920 6F	0 460 494 459	1980 71	0 445 110 044	96 154 523	0 986 430 371	96 372 779	0 986 435 014
1920 6X	0 445 010 010	1980 71	0 986 435 003	96 154 524	0 432 217 270	96 373 173	0 445 010 042
1920 6X	0 986 437 005	1980 72	0 445 110 044	96 154 526	0 432 217 268	96 373 173	0 986 437 309
1920 7G	0 460 484 137	1980 72	0 986 435 003	96 154 526	0 986 430 381	96 375 360	0 445 110 044
1920 7H	0 986 440 161	1980 73	0 445 110 036	96 155 902	0 460 494 313	96 375 360	0 986 435 003
1920 8A	0 460 484 131	1980 73	0 986 435 014	96 173 516	0 460 494 278	96 376 359	0 445 010 042
1920 8C	0 460 484 146	1980 77	0 445 110 062	96 180 183	0 460 484 064	96 376 359	0 986 437 309
1920 8K	0 460 494 467	1980 77	0 986 435 077	96 183 769	0 432 193 728	96 38 444 780	0 986 435 013
1920 87	0 460 494 223	1980 78	0 445 110 057	96 189 578	0 460 484 070	96 38 444 880	0 986 435 014
1979 45	0 986 430 010	1980 78	0 986 435 093	96 190 451	0 460 494 367	96 38 444 980	0 986 435 015
1979 46	0 986 430 015	1980 79	0 445 110 057	96 219 885	0 460 484 091	96 384 889	0 445 110 057
1979 46	0 986 430 028	1980 79	0 986 435 093	96 219 895	0 460 494 382	96 384 889	0 986 435 093
1979 47	0 986 430 015	1980 80	0 445 110 057	96 222 802	0 460 494 278	96 386 523	0 445 110 075
1979 47	0 986 430 028	1980 80	0 986 435 093	96 222 804	0 460 494 344	96 386 523	0 986 435 076
1980 A9	0 445 110 135	1980 81	0 445 120 002	96 227 102	0 460 494 446	96 400 887	0 445 110 062
1980 A9	0 986 435 085	1980 81	0 986 435 501	96 227 298	0 432 217 286	96 400 887	0 986 435 077
1980 EJ	0 445 110 339	1980 83	0 445 120 002	96 227 365	0 986 430 375	96 408 953	0 445 110 044
1980 E5	0 445 110 136	1980 83	0 986 435 501	96 227 367	0 986 430 375	96 408 953	0 986 435 003
1980 E5	0 445 110 188	1980 84	0 445 110 076	96 227 398	0 432 217 286	96 414 961	0 445 110 075
1980 E5	0 986 435 090	1980 84	0 986 435 077	96 238 110	0 460 494 384	96 414 961	0 986 435 076
1980 H2	0 445 110 239	1980 85	0 445 110 076	96 240 260	0 460 484 070	96 416 540	0 445 110 057
1980 H2	0 986 435 122	1980 85	0 986 435 077	96 246 852	0 986 440 051	96 416 540	0 986 435 093
1980 H3	0 445 110 188	1980 86	0 445 110 076	96 254 185	0 460 494 411	96 416 541	0 445 110 057
1980 H3	0 986 435 090	1980 86	0 986 435 077	96 254 186	0 460 494 412	96 416 541	0 986 435 093
1980 H4	0 445 110 036	1980 89	0 445 110 075	96 254 187	0 460 494 423	96 416 542	0 445 110 057
1980 H4	0 986 435 014	1980 89	0 986 435 076	96 254 187	0 986 440 156	96 416 542	0 986 435 093
1980 H5	0 445 110 036	1980 93	0 445 110 044	96 254 193	0 460 494 384	96 419 449	0 445 110 076
1980 H5	0 986 435 014	1980 93	0 986 435 003	96 255 425	0 986 435 003	96 419 449	0 986 435 077
1980 H6	0 445 110 036	1984 40	0 986 430 028	96 256 277	0 460 484 131	96 419 450	0 445 110 076
1980 H6	0 986 435 014	93 501 009	0 460 494 079	96 259 523	0 460 484 111	96 419 450	0 986 435 077
1980 H7	0 445 110 076	93 501 010	0 460 494 121	96 259 538	0 460 494 430	96 419 451	0 445 110 076
1980 H7	0 986 435 077	93 50 109 180	0 986 430 015	96 264 661	0 432 217 301	96 419 451	0 986 435 077
1980 H8	0 445 110 076	93 50 109 180	0 986 430 028	96 272 026	0 460 484 109	96 421 669	0 445 010 046
1980 H8	0 986 435 077	93 50 138 080	0 986 430 010	96 276 639	0 445 010 021	96 466 862	0 445 110 136
1980 H9	0 445 110 076	93 51 045 480	0 986 430 028	96 276 639	0 986 437 012	96 466 862	0 986 435 090
1980 H9	0 986 435 077	96 004 017	0 986 430 028	96 282 404	0 445 110 036	96 481 471	0 445 010 089



## ◀ CITROEN

96 481 471	<b>0 986 437 322</b>	2 830 251	<b>0 460 424 285</b>	3 288 251	<b>0 460 426 377</b>	3 863 228	<b>0 432 131 741</b>
96 485 754	<b>0 445 110 136</b>	2 830 957	<b>0 445 120 007</b>	3 288 251	<b>0 460 426 383</b>	3 863 231	<b>0 432 131 690</b>
96 485 754	<b>0 986 435 090</b>	2 830 957	<b>0 986 435 508</b>	3 288 253	<b>0 460 426 382</b>	3 863 392	<b>0 432 131 717</b>
96 487 862	<b>0 445 110 135</b>	2 880 157	<b>0 444 042 013</b>	3 288 255	<b>0 460 426 365</b>	3 863 470	<b>0 432 131 689</b>
96 487 862	<b>0 986 435 085</b>	2 880 158	<b>0 444 042 004</b>	3 288 255	<b>0 460 426 377</b>	3 863 470	<b>0 432 131 710</b>
96 492 841	<b>0 445 010 089</b>	3 092 022	<b>0 432 191 532</b>	3 288 255	<b>0 460 426 383</b>	3 863 633	<b>0 432 131 697</b>
96 492 841	<b>0 986 437 322</b>	3 092 639	<b>0 432 292 861</b>	3 288 256	<b>0 432 133 772</b>	3 863 826	<b>0 432 131 679</b>
96 507 606	<b>0 445 110 136</b>	3 093 282	<b>0 432 191 409</b>	3 319 010	<b>0 432 133 853</b>	3 865 968	<b>0 432 131 715</b>
96 507 606	<b>0 986 435 090</b>	3 093 283	<b>0 432 191 410</b>	3 349 084	<b>0 432 131 693</b>	3 897 197	<b>0 432 133 854</b>
96 518 443	<b>0 445 010 089</b>	3 093 293	<b>0 432 292 860</b>	3 355 015	<b>9 430 082 747</b>	3 897 198	<b>0 432 191 636</b>
96 518 443	<b>0 986 437 322</b>	3 093 346	<b>9 430 612 143</b>	3 355 043	<b>9 430 082 748</b>	3 897 205	<b>0 432 191 569</b>
96 528 920	<b>0 445 110 188</b>	3 093 414	<b>0 432 191 447</b>	3 355 246	<b>9 430 082 753</b>	3 897 596	<b>0 432 131 753</b>
96 528 920	<b>0 986 435 090</b>	3 093 415	<b>0 432 191 448</b>	3 355 320	<b>9 430 082 751</b>	3 898 387	<b>0 432 191 628</b>
96 533 448	<b>0 445 110 036</b>	3 093 996	<b>0 432 292 863</b>	3 356 053	<b>9 430 082 762</b>	3 902 969	<b>0 432 131 882</b>
96 533 448	<b>0 986 435 014</b>	3 094 292	<b>0 432 292 863</b>	3 356 163	<b>0 460 424 126</b>	3 902 980	<b>0 432 131 877</b>
96 535 942	<b>0 445 110 076</b>	3 280 567	<b>0 432 131 852</b>	3 356 222	<b>0 460 426 251</b>	3 904 197	<b>0 432 131 880</b>
96 535 942	<b>0 986 435 077</b>	3 280 787	<b>0 432 131 849</b>	3 356 379	<b>0 460 424 144</b>	3 905 438	<b>0 432 133 889</b>
96 550 450	<b>0 445 110 188</b>	3 281 180	<b>0 460 426 196</b>	3 356 407	<b>0 460 424 183</b>	3 905 454	<b>0 432 133 888</b>
96 550 450	<b>0 986 435 090</b>	3 281 191	<b>0 432 133 853</b>	3 356 500	<b>0 460 426 305</b>	3 907 648	<b>0 460 426 091</b>
96 561 543	<b>0 445 010 132</b>	3 281 781	<b>0 460 426 211</b>	3 356 500	<b>0 460 426 324</b>	3 908 505	<b>0 432 191 804</b>
96 565 889	<b>0 445 110 252</b>	3 281 825	<b>0 432 133 868</b>	3 356 501	<b>0 460 426 298</b>	3 908 506	<b>0 432 191 804</b>
96 565 889	<b>0 986 435 143</b>	3 281 848	<b>0 460 426 212</b>	3 356 587	<b>F 000 439 007</b>	3 908 507	<b>0 432 191 812</b>
96 589 498	<b>0 445 110 285</b>	3 281 849	<b>0 460 426 213</b>	3 356 591	<b>F 000 439 004</b>	3 908 509	<b>0 432 191 799</b>
96 592 288	<b>0 445 115 025</b>	3 282 191	<b>0 432 133 853</b>	3 356 610	<b>0 460 426 291</b>	3 908 511	<b>0 432 191 796</b>
96 592 288	<b>0 986 435 351</b>	3 282 306	<b>0 460 426 270</b>	3 356 731	<b>0 460 424 185</b>	3 908 513	<b>0 432 191 794</b>
96 592 291	<b>0 445 115 042</b>	3 282 359	<b>0 432 133 851</b>	3 356 745	<b>0 460 426 299</b>	3 909 306	<b>0 432 131 838</b>
96 592 291	<b>0 986 435 362</b>	3 282 595	<b>0 460 426 244</b>	3 356 852	<b>0 460 424 186</b>	3 909 454	<b>0 432 131 882</b>
96 592 405	<b>0 445 110 281</b>	3 282 614	<b>0 460 426 244</b>	3 356 852	<b>0 460 424 204</b>	3 909 464	<b>0 432 131 877</b>
96 592 405	<b>0 986 435 150</b>	3 282 743	<b>0 460 426 249</b>	3 356 853	<b>F 000 439 009</b>	3 909 475	<b>0 432 131 881</b>
96 596 666	<b>0 445 110 239</b>	3 282 744	<b>0 460 426 246</b>	3 356 857	<b>F 000 439 007</b>	3 909 476	<b>0 432 131 880</b>
96 596 666	<b>0 986 435 122</b>	3 282 753	<b>0 460 426 245</b>	3 356 941	<b>F 000 439 010</b>	3 909 522	<b>0 432 133 888</b>
		3 282 754	<b>0 432 133 846</b>	3 357 045	<b>0 460 424 204</b>	3 909 532	<b>0 432 131 875</b>
		3 282 755	<b>0 460 426 254</b>	3 357 046	<b>F 000 439 011</b>	3 909 533	<b>0 432 131 876</b>
		3 282 756	<b>0 432 133 845</b>	3 357 047	<b>0 460 424 203</b>	3 911 179	<b>0 460 424 085</b>
		3 282 815	<b>0 460 426 272</b>	3 357 115	<b>0 460 424 208</b>	3 911 350	<b>9 430 082 715</b>
		3 282 816	<b>0 460 426 282</b>	3 357 117	<b>0 460 424 209</b>	3 912 133	<b>0 460 426 106</b>
		3 282 824	<b>0 460 426 271</b>	3 357 163	<b>0 460 426 325</b>	3 913 343	<b>0 432 131 835</b>
		3 282 948	<b>0 432 133 843</b>	3 357 164	<b>0 460 426 322</b>	3 913 443	<b>0 460 424 079</b>
		3 283 026	<b>0 460 426 249</b>	3 357 165	<b>0 460 426 323</b>	3 913 590	<b>0 460 424 012</b>
		3 283 160	<b>0 432 191 592</b>	3 357 166	<b>0 460 426 324</b>	3 913 735	<b>0 432 191 756</b>
		3 283 170	<b>0 460 426 249</b>	3 357 242	<b>F 000 439 015</b>	3 914 472	<b>0 432 131 869</b>
		3 283 171	<b>0 460 426 249</b>	3 357 250	<b>0 460 426 326</b>	3 914 473	<b>0 432 131 856</b>
		3 283 172	<b>0 460 426 249</b>	3 357 294	<b>0 460 426 327</b>	3 914 474	<b>0 432 131 854</b>
		3 283 180	<b>0 432 131 722</b>	3 357 420	<b>0 460 424 226</b>	3 914 487	<b>0 460 424 046</b>
		3 283 396	<b>0 460 424 143</b>	3 357 444	<b>0 460 424 231</b>	3 914 924	<b>0 460 424 055</b>
		3 283 507	<b>0 432 133 838</b>	3 357 445	<b>0 460 424 230</b>	3 914 928	<b>0 460 426 130</b>
		3 283 561	<b>0 432 133 838</b>	3 357 448	<b>F 000 439 017</b>	3 914 932	<b>0 460 424 054</b>
		3 283 562	<b>0 432 133 837</b>	3 357 580	<b>0 460 426 342</b>	3 915 735	<b>0 460 426 132</b>
		3 283 571	<b>0 460 424 143</b>	3 357 582	<b>F 000 439 018</b>	3 916 894	<b>0 460 426 144</b>
		3 283 591	<b>0 460 424 143</b>	3 357 660	<b>F 000 439 019</b>	3 916 904	<b>0 460 426 146</b>
		3 284 180	<b>0 460 426 249</b>	3 393 7167 RX	<b>0 986 444 009</b>	3 916 908	<b>0 460 426 148</b>
		3 284 500	<b>0 460 426 306</b>	3 802 818	<b>0 432 131 753</b>	3 916 910	<b>0 460 426 151</b>
		3 288 249	<b>0 460 426 367</b>	3 802 851	<b>0 432 191 569</b>	3 916 913	<b>0 460 426 163</b>
		3 288 249	<b>0 460 426 375</b>	3 863 102	<b>0 432 131 740</b>	3 916 914	<b>0 460 426 163</b>
		3 288 251	<b>0 460 426 369</b>	3 863 228	<b>0 432 131 688</b>	3 916 922	<b>0 460 426 155</b>

## CLAAS

397 090 5 **0 432 133 770**

## CLARK

6005007661 **0 432 291 671**

## CUMMINS

A 029 C02 3 **0 444 042 013**A029G402 **0 444 042 017**0 000 5040 **0 445 020 122**0 28Y 793 **0 444 042 004**2 830 224 **0 445 120 007**2 830 224 **0 986 435 508**2 830 244 **0 445 120 007**2 830 244 **0 986 435 508**

3916 923	<b>0 460 426 177</b>	3919 302	<b>0 432 131 840</b>	3935 993	<b>0 460 424 188</b>	3957 423	<b>0 460 424 291</b>
3916 925	<b>0 460 424 057</b>	3919 304	<b>0 432 131 839</b>	3936 618	<b>0 460 426 332</b>	3957 694	<b>0 460 424 290</b>
3916 929	<b>0 460 424 062</b>	3919 306	<b>0 432 131 838</b>	3936 618	<b>0 460 426 334</b>	3957 694	<b>0 460 424 291</b>
3916 931	<b>0 460 426 164</b>	3919 339	<b>0 432 131 837</b>	3936 619	<b>0 460 426 333</b>	3957 729	<b>0 432 133 781</b>
3916 934	<b>0 460 426 157</b>	3919 343	<b>0 432 131 835</b>	3936 619	<b>0 460 426 335</b>	3959 106	<b>F 000 439 021</b>
3916 936	<b>0 460 426 152</b>	3919 347	<b>0 432 133 874</b>	3936 628	<b>0 460 426 337</b>	3959 107	<b>F 000 439 021</b>
3916 946	<b>0 460 426 156</b>	3919 350	<b>0 432 131 837</b>	3937 157	<b>0 470 506 014</b>	3963 716	<b>0 460 424 271</b>
3916 947	<b>0 460 426 141</b>	3919 582	<b>9 430 082 743</b>	3937 160	<b>0 470 506 022</b>	3963 717	<b>0 460 426 358</b>
3916 948	<b>0 460 426 185</b>	3919 602	<b>0 432 191 738</b>	3937 167	<b>0 986 444 009</b>	3963 717	<b>0 460 426 359</b>
3916 968	<b>0 460 426 154</b>	3919 744	<b>0 432 133 875</b>	3937 396	<b>0 460 424 217</b>	3963 949	<b>0 460 426 367</b>
3916 969	<b>0 460 426 154</b>	3919 846	<b>0 460 424 081</b>	3937 400	<b>0 460 424 218</b>	3963 951	<b>0 460 426 369</b>
3916 972	<b>0 460 426 167</b>	3919 956	<b>0 432 133 876</b>	3937 507	<b>0 432 131 656</b>	3963 952	<b>0 460 426 367</b>
3916 974	<b>0 460 426 154</b>	3920 140	<b>0 432 191 735</b>	3937 670	<b>0 470 506 028</b>	3963 952	<b>0 460 426 369</b>
3916 978	<b>0 460 426 153</b>	3921 179	<b>0 460 424 085</b>	3937 671	<b>0 470 506 027</b>	3963 953	<b>0 460 426 365</b>
3916 987	<b>0 460 426 174</b>	3921 180	<b>0 460 426 196</b>	3937 673	<b>0 470 506 034</b>	3963 955	<b>0 460 426 368</b>
3916 991	<b>0 460 426 114</b>	3921 727	<b>0 460 424 119</b>	3937 673	<b>0 986 444 052</b>	3963955-NX	<b>0 460 426 368</b>
3916 994	<b>0 460 426 130</b>	3921 739	<b>0 460 426 234</b>	3937 690	<b>0 470 506 041</b>	3963 957	<b>0 460 426 366</b>
3917 002	<b>0 460 426 142</b>	3921 835	<b>0 432 191 718</b>	3937 690	<b>0 986 444 054</b>	3963 959	<b>0 460 426 373</b>
3917 010	<b>0 460 426 132</b>	3922 411	<b>0 460 426 200</b>	3938 430	<b>0 432 191 354</b>	3963 960	<b>0 460 426 385</b>
3917 012	<b>0 460 426 149</b>	3924 013	<b>0 432 133 864</b>	3938 431	<b>0 432 191 343</b>	3963 961	<b>0 460 424 289</b>
3917 016	<b>0 460 424 066</b>	3924 896	<b>0 432 131 799</b>	3939 535	<b>0 432 191 357</b>	3963 963	<b>0 460 424 288</b>
3917 023	<b>0 460 424 064</b>	3926 120	<b>0 432 191 642</b>	3939 696	<b>0 432 133 787</b>	3963 965	<b>0 460 424 287</b>
3917 027	<b>0 460 424 059</b>	3926 787	<b>0 432 191 632</b>	3939 696	<b>0 432 133 878</b>	3963 966	<b>0 460 424 287</b>
3917 029	<b>0 460 424 060</b>	3926 817	<b>0 432 133 859</b>	3939 808	<b>0 432 191 338</b>	3964 009	<b>0 445 020 011</b>
3917 035	<b>0 460 424 061</b>	3926 818	<b>0 432 133 860</b>	3939 826	<b>0 432 191 355</b>	3964 273	<b>0 445 120 032</b>
3917 037	<b>0 460 426 150</b>	3926 819	<b>0 432 133 861</b>	3939 832	<b>0 432 191 349</b>	3964 555	<b>0 470 506 029</b>
3917 038	<b>0 460 426 149</b>	3926 820	<b>0 432 133 858</b>	3939 837	<b>0 432 191 335</b>	3964 556	<b>0 470 506 040</b>
3917 040	<b>0 432 131 851</b>	3927 320	<b>0 432 133 857</b>	3943 238	<b>0 470 506 013</b>	3964 556	<b>0 986 444 053</b>
3917 507	<b>0 460 424 058</b>	3927 618	<b>0 432 133 849</b>	3943 238	<b>0 986 444 023</b>	3964 771	<b>F 000 439 023</b>
3917 510	<b>0 460 424 060</b>	3928 228	<b>0 432 191 601</b>	3944 183	<b>0 432 193 635</b>	3964 815	<b>0 460 424 209</b>
3917 516	<b>0 460 424 065</b>	3928 384	<b>0 432 191 629</b>	3944 191	<b>0 432 193 649</b>	3964 919	<b>0 432 133 773</b>
3917 517	<b>0 460 424 078</b>	3928 387	<b>0 432 191 628</b>	3944 194	<b>0 432 193 648</b>	3965 090	<b>0 445 020 015</b>
3917 519	<b>0 460 424 063</b>	3928 658	<b>0 460 426 243</b>	3944 197	<b>0 432 193 647</b>	3965 145	<b>0 432 193 485</b>
3917 521	<b>0 460 424 069</b>	3929 094	<b>9 430 082 761</b>	3944 200	<b>0 432 193 645</b>	3965 402	<b>0 470 006 005</b>
3917 523	<b>0 460 424 067</b>	3929 490	<b>0 432 131 749</b>	3944 205	<b>0 432 193 646</b>	3965 402	<b>0 986 444 509</b>
3917 528	<b>0 460 424 074</b>	3929 905	<b>0 460 426 142</b>	3944 211	<b>0 432 191 498</b>	3965 403	<b>0 470 006 006</b>
3917 531	<b>0 460 424 055</b>	3930 131	<b>0 432 131 743</b>	3944 536	<b>0 470 506 007</b>	3965 403	<b>0 986 444 510</b>
3917 535	<b>0 460 424 054</b>	3930 523	<b>0 432 191 594</b>	3944 828	<b>0 432 193 629</b>	3965 404	<b>0 470 004 018</b>
3917 539	<b>0 460 424 073</b>	3930 525	<b>0 432 191 595</b>	3944 829	<b>0 432 193 630</b>	3965 404	<b>0 986 444 507</b>
3917 542	<b>0 460 426 137</b>	3930 573	<b>0 432 131 698</b>	3944 893	<b>0 470 506 012</b>	3965 405	<b>0 470 004 019</b>
3917 549	<b>0 460 424 071</b>	3930 573	<b>0 432 131 740</b>	3944 893	<b>0 986 444 032</b>	3965 405	<b>0 986 444 508</b>
3917 556	<b>0 460 426 165</b>	3931 735	<b>0 432 191 531</b>	3945 340	<b>0 432 191 484</b>	3965 749	<b>0 445 120 038</b>
3917 559	<b>0 460 426 147</b>	3931 795	<b>0 432 131 718</b>	3946 218	<b>0 986 444 018</b>	3966 818	<b>0 432 191 300</b>
3917 562	<b>0 460 426 166</b>	3931 862	<b>F 002 C8Z 201</b>	3946 306	<b>0 432 193 581</b>	3966 819	<b>0 432 191 299</b>
3917 563	<b>0 460 426 138</b>	3931 945	<b>0 432 191 576</b>	3947 032	<b>0 470 506 022</b>	3966 820	<b>0 432 191 298</b>
3917 632	<b>0 460 426 173</b>	3932 123	<b>0 432 131 694</b>	394 7032-RX	<b>0 986 444 007</b>	3967 597	<b>0 432 131 753</b>
3918 282	<b>0 460 426 143</b>	3932 123	<b>0 432 131 717</b>	3948 523	<b>0 432 191 391</b>	3968 158	<b>0 445 120 032</b>
3918 509	<b>0 432 191 799</b>	3935 033	<b>0 432 131 681</b>	3948 525	<b>0 432 191 392</b>	3968 391	<b>0 460 424 305</b>
3918 965	<b>0 432 133 877</b>	3935 213	<b>0 432 131 676</b>	3948 527	<b>0 432 191 389</b>	3968 394	<b>0 460 424 277</b>
3919 010	<b>0 432 133 873</b>	3935 669	<b>0 460 424 187</b>	3948 529	<b>0 432 191 426</b>	3969 827	<b>F 000 439 022</b>
3919 058	<b>0 432 191 740</b>	3935 671	<b>0 460 424 201</b>	3948 608	<b>0 432 191 422</b>	3970 820	<b>0 460 424 331</b>
3919 091	<b>0 432 133 879</b>	3935 673	<b>0 460 424 190</b>	3948 636	<b>0 432 191 390</b>	3970 821	<b>0 460 424 332</b>
3919 092	<b>0 432 133 878</b>	3935 677	<b>0 460 424 191</b>	3949 619	<b>0 445 120 018</b>	3970 902	<b>0 460 424 348</b>
3919 298	<b>0 432 131 841</b>	3935 679	<b>0 460 424 189</b>	3949 619	<b>0 986 435 503</b>	3970 905	<b>0 432 133 770</b>
3919 300	<b>0 432 131 834</b>	3935 991	<b>0 460 424 199</b>	3957 423	<b>0 460 424 290</b>	3971 529	<b>0 445 020 045</b>













## ◀ FORD

1C1Q9 K546 CA	<b>0 432 133 790</b>	1011039	<b>0 460 414 119</b>	1128170	<b>0 432 133 800</b>	1254398	<b>0 986 435 090</b>
1S7Q9 A543 AA	<b>0 986 444 079</b>	1011039	<b>0 986 440 046</b>	1128172	<b>0 432 133 801</b>	1255376	<b>0 470 004 012</b>
1S7Q9 A543 AB	<b>0 986 444 079</b>	1011042	<b>0 986 440 043</b>	1128394	<b>0 986 440 053</b>	1255376	<b>0 986 444 522</b>
1S7Q9 A543 AC	<b>0 986 444 079</b>	1011044	<b>0 986 440 048</b>	1129191	<b>0 432 133 791</b>	1255376	<b>0 986 444 523</b>
1S7Q9 A543 AD	<b>0 986 444 079</b>	1011048	<b>0 986 440 048</b>	1129192	<b>0 432 133 790</b>	1255378	<b>0 470 004 013</b>
1S7Q9 A543 AE	<b>0 470 504 035</b>	1011058	<b>0 986 430 249</b>	1129660	<b>0 470 004 013</b>	1255378	<b>0 986 444 520</b>
1S7Q9 A543 AE	<b>0 986 444 075</b>	1011059	<b>0 432 217 249</b>	1129660	<b>0 986 444 520</b>	1302192	<b>0 470 504 018</b>
1S7Q9 A543 AF	<b>0 470 504 035</b>	1027140	<b>0 460 404 971</b>	1129661	<b>0 986 444 079</b>	1302192	<b>0 986 444 078</b>
1S7Q9 A543 AF	<b>0 986 444 075</b>	1027140	<b>0 986 440 555</b>	1130379	<b>0 470 004 012</b>	1306485	<b>0 470 004 008</b>
1S7Q9 A543 BB	<b>0 986 444 520</b>	1030438	<b>0 986 440 567</b>	1130379	<b>0 986 444 522</b>	1306485	<b>0 986 444 521</b>
1S7Q9 A543 BC	<b>0 986 444 520</b>	1030582	<b>0 432 193 746</b>	1130379	<b>0 986 444 523</b>	1313844	<b>0 445 010 089</b>
1S7Q9 A543 BD	<b>0 986 444 520</b>	1030727	<b>0 432 193 744</b>	1131699	<b>0 986 444 079</b>	1313844	<b>0 986 437 322</b>
1S7Q9 A543 BE	<b>0 986 444 520</b>	1039375	<b>0 460 414 150</b>	1131855	<b>0 414 720 088</b>	1314310	<b>0 986 444 075</b>
1S7Q9 A543 BF	<b>0 986 444 520</b>	1047197	<b>0 432 217 293</b>	1131855	<b>0 986 441 554</b>	1319288	<b>0 470 504 041</b>
1S7Q9 A543 BG	<b>0 986 444 520</b>	1047197	<b>0 986 430 520</b>	1131971	<b>0 986 441 553</b>	1319288	<b>0 986 444 076</b>
1S7Q9 A543 BH	<b>0 986 444 520</b>	1049608	<b>0 460 414 152</b>	1131973	<b>0 986 444 519</b>	1326820	<b>0 445 110 188</b>
1S7Q9 A543 BJ	<b>0 986 444 520</b>	1049608	<b>0 986 440 056</b>	1131977	<b>0 414 720 088</b>	1326820	<b>0 986 435 090</b>
1S7Q9 A543 BK	<b>0 986 444 520</b>	1049609	<b>0 460 414 153</b>	1131977	<b>0 986 441 554</b>	1336633	<b>0 986 444 519</b>
1S7Q9 A543 SB	<b>0 470 004 013</b>	1049609	<b>0 986 440 219</b>	1131978	<b>0 470 004 008</b>	1338377	<b>0 986 444 078</b>
1S7Q9 A543 SB	<b>0 986 444 520</b>	1051791	<b>0 986 440 052</b>	1131978	<b>0 986 444 521</b>	1347282	<b>0 445 010 296</b>
1S7Q9 A543 SC	<b>0 470 004 013</b>	1063426	<b>0 460 414 142</b>	1131980	<b>0 470 004 013</b>	1347283	<b>0 445 110 239</b>
1S7Q9 A543 SC	<b>0 986 444 520</b>	1063427	<b>0 986 440 052</b>	1131980	<b>0 986 444 520</b>	1347283	<b>0 986 435 122</b>
1S7Q9 A543 SD	<b>0 470 004 013</b>	1063428	<b>0 460 414 146</b>	1131982	<b>0 986 440 226</b>	1347778	<b>0 986 444 076</b>
1S7Q9 A543 SD	<b>0 986 444 520</b>	1063428	<b>0 986 440 054</b>	1131983	<b>0 986 440 107</b>	1353009	<b>0 470 004 012</b>
1S7Q9 A543 SE	<b>0 470 004 013</b>	1066353	<b>0 460 484 143</b>	1131984	<b>0 986 440 225</b>	1353013	<b>0 470 504 041</b>
1S7Q9 A543 SE	<b>0 986 444 520</b>	1066353	<b>0 986 440 107</b>	1139871	<b>0 470 004 008</b>	1353014	<b>0 470 004 008</b>
1S7Q9 A543 SF	<b>0 470 004 013</b>	1072298	<b>0 460 404 971</b>	1139871	<b>0 986 444 521</b>	1353014	<b>0 986 444 521</b>
1S7Q9 A543 SF	<b>0 986 444 520</b>	1072298	<b>0 986 440 555</b>	1141377	<b>0 460 414 216</b>	1353015	<b>0 470 004 013</b>
1S7Q9 A543 SG	<b>0 470 004 013</b>	1077607	<b>0 460 414 142</b>	1151423	<b>0 986 444 519</b>	1353015	<b>0 986 444 520</b>
1S7Q9 A543 SG	<b>0 986 444 520</b>	1077607	<b>0 986 440 217</b>	1151425	<b>0 470 504 036</b>	1353439	<b>0 986 444 522</b>
1S7Q9 A543 SH	<b>0 470 004 013</b>	1077608	<b>0 986 440 052</b>	1206303	<b>0 414 720 088</b>	1353439	<b>0 986 444 523</b>
1S7Q9 A543 SH	<b>0 986 444 520</b>	1077609	<b>0 460 414 146</b>	1206303	<b>0 986 441 554</b>	1366613	<b>0 445 110 188</b>
1S7Q9 A543 TA	<b>0 986 444 079</b>	1077609	<b>0 986 440 054</b>	1206322	<b>0 414 720 086</b>	1366613	<b>0 986 435 090</b>
1S7Q9 A543 TD	<b>0 470 504 036</b>	1077610	<b>0 986 440 053</b>	1206322	<b>0 986 441 553</b>	1376261	<b>0 445 010 296</b>
1S7Q9 A543 TD	<b>0 986 444 075</b>	1093872	<b>0 986 444 519</b>	1209171	<b>0 470 004 012</b>	1431650	<b>0 986 441 560</b>
1S7Q9 A543 TE	<b>0 470 504 036</b>	1100801	<b>0 986 440 567</b>	1209171	<b>0 986 444 522</b>	1477146	<b>0 445 110 239</b>
1S7Q9 A543 TE	<b>0 986 444 075</b>	1100802	<b>0 986 440 555</b>	1209171	<b>0 986 444 523</b>	1477146	<b>0 986 435 122</b>
1S7Q9 K546 AB	<b>0 432 133 801</b>	1100984	<b>0 414 720 014</b>	1213937	<b>0 986 444 522</b>	1490844	<b>0 445 010 296</b>
1S7Q9 K546 AC	<b>0 432 133 801</b>	1104228	<b>0 470 004 012</b>	1213937	<b>0 986 444 523</b>	1490844	<b>0 986 437 028</b>
1S7Q9 K546 AD	<b>0 432 133 801</b>	1104228	<b>0 986 444 522</b>	1214221	<b>0 470 004 008</b>	1492204	<b>0 445 010 367</b>
1S7Q9 K546 BB	<b>0 432 133 800</b>	1104228	<b>0 986 444 523</b>	1214221	<b>0 986 444 521</b>	1496269	<b>0 445 010 296</b>
1S7Q9 K546 BC	<b>0 432 133 800</b>	1104229	<b>0 470 504 018</b>	1219313	<b>0 470 504 036</b>	1496269	<b>0 986 437 028</b>
1S7Q9 K546 BD	<b>0 432 133 800</b>	1104229	<b>0 986 444 078</b>	1219313	<b>0 986 444 075</b>	1509239	<b>0 445 115 025</b>
1S7Q9 K546 BE	<b>0 432 133 800</b>	1105530	<b>0 460 484 150</b>	1223678	<b>0 432 133 800</b>	1509239	<b>0 986 435 351</b>
1S7Q9 K564 AA	<b>0 432 133 801</b>	1105530	<b>0 986 440 225</b>	1226232	<b>0 470 004 013</b>	1538758	<b>0 445 110 183</b>
1S7Q9 K564 AC	<b>0 432 133 801</b>	1105531	<b>0 460 484 152</b>	1226232	<b>0 986 444 520</b>	1539539	<b>0 445 010 276</b>
1S7Q9 K564 BA	<b>0 432 133 800</b>	1105531	<b>0 986 440 226</b>	1226249	<b>0 470 004 012</b>	1566426	<b>0 986 437 028</b>
1S7Q9 K564 BC	<b>0 432 133 800</b>	1111908	<b>0 470 004 008</b>	1227039	<b>0 470 504 018</b>	1566431	<b>0 986 435 122</b>
1003090	<b>0 432 193 829</b>	1111908	<b>0 986 444 521</b>	1227039	<b>0 986 444 078</b>	1566432	<b>0 986 435 090</b>
1005830	<b>0 432 217 293</b>	1127405	<b>0 986 440 219</b>	1229572	<b>0 986 444 519</b>	1633633	<b>0 445 110 352</b>
1005830	<b>0 986 430 520</b>	1127406	<b>0 986 440 054</b>	1230996	<b>0 445 010 089</b>	2C246 9F593 AA	<b>0 445 120 025</b>
1010441	<b>0 432 193 838</b>	1127407	<b>0 986 440 055</b>	1230996	<b>0 986 437 322</b>	2C469 D376 AA	<b>0 445 020 019</b>
1010442	<b>0 432 193 829</b>	1127456	<b>0 986 440 056</b>	1253765	<b>0 414 720 266</b>	2C469 F593 AA	<b>0 445 120 025</b>
1011035	<b>0 986 440 040</b>	1127470	<b>0 986 440 217</b>	1253765	<b>0 986 441 560</b>	2C469 F5936 AA	<b>0 445 120 025</b>
1011037	<b>0 986 440 046</b>	1127478	<b>0 986 440 052</b>	1254398	<b>0 445 110 136</b>	2RD 130201	<b>9 430 082 752</b>





1-15300-033-1	9 430 611 282	1-15300-138-1	9 430 611 064	1-15300-241-0	9 430 611 435	1-15300-306-0	9 430 611 804
1-15300-033-2	9 430 612 954	1-15300-138-2	9 430 611 065	1-15300-241-1	9 430 611 436	1-15300-307-0	9 430 613 005
1-15300-038-0	9 430 611 286	1-15300-141-0	9 430 611 066	1-15300-242-0	9 430 611 412	1-15300-307-1	9 430 613 000
1-15300-038-2	9 430 610 751	1-15300-142-0	9 430 610 995	1-15300-244-0	9 430 611 416	1-15300-307-2	9 430 613 001
1-15300-040-0	9 430 611 304	1-15300-142-1	9 430 610 996	1-15300-247-0	9 430 611 421	1-15300-309-0	9 430 613 477
1-15300-040-1	9 430 611 305	1-15300-143-0	9 430 612 963	1-15300-248-0	9 430 612 510	1-15300-314-0	9 430 611 623
1-15300-041-1	9 430 611 300	1-15300-143-1	9 430 612 962	1-15300-249-0	9 430 612 513	1-15300-315-1	9 430 611 805
1-15300-041-2	9 430 611 301	1-15300-146-1	9 430 611 001	1-15300-249-1	9 430 612 514	1-15300-317-0	9 430 611 615
1-15300-057-2	9 430 610 800	1-15300-146-2	9 430 611 002	1-15300-250-1	9 430 611 424	1-15300-328-0	9 430 611 631
1-15300-057-3	9 430 610 801	1-15300-149-0	9 430 611 084	1-15300-251-0	9 430 611 426	1-15300-331-0	9 430 610 525
1-15300-065-1	9 430 610 890	1-15300-151-0	9 430 611 014	1-15300-251-1	9 430 611 427	1-15300-333-0	9 430 611 810
1-15300-070-1	9 430 610 756	1-15300-155-0	9 430 611 021	1-15300-254-0	9 430 611 429	1-15300-334-0	9 430 611 813
1-15300-070-2	9 430 610 757	1-15300-155-1	9 430 611 022	1-15300-259-0	9 430 611 537	1-15300-335-0	9 430 611 825
1-15300-070-3	9 430 610 758	1-15300-159-0	9 430 611 062	1-15300-260-0	9 430 611 539	1-15300-336-0	9 430 611 939
1-15300-075-1	9 430 610 766	1-15300-159-1	9 430 611 063	1-15300-261-0	9 430 611 755	1-15300-336-1	9 430 611 940
1-15300-083-0	9 430 610 805	1-15300-160-0	9 430 611 037	1-15300-266-1	9 430 612 523	1-15300-337-0	9 430 610 539
1-15300-083-1	9 430 610 806	1-15300-163-0	9 430 612 978	1-15300-266-2	9 430 613 319	1-15300-338-0	9 430 612 760
1-15300-084-0	9 430 610 820	1-15300-163-1	9 430 611 086	1-15300-266-3	9 430 613 289	1-15300-339-0	9 430 611 832
1-15300-085-0	9 430 610 828	1-15300-164-0	9 430 611 094	1-15300-269-0	9 430 611 552	1-15300-339-1	9 430 611 833
1-15300-086-0	9 430 610 813	1-15300-166-0	9 430 611 057	1-15300-269-1	9 430 611 553	1-15300-340-0	9 430 612 759
1-15300-087-2	9 430 610 873	1-15300-168-0	9 430 611 056	1-15300-272-0	9 430 611 472	1-15300-340-1	9 430 611 819
1-15300-087-3	9 430 610 874	1-15300-170-0	9 430 611 052	1-15300-274-0	9 430 613 292	1-15300-341-0	9 430 613 090
1-15300-088-1	9 430 610 829	1-15300-171-0	9 430 611 054	1-15300-274-3	9 430 612 542	1-15300-343-0	9 430 610 554
1-15300-092-0	9 430 610 854	1-15300-172-0	9 430 611 061	1-15300-274-4	9 430 613 293	1-15300-344-0	9 430 612 758
1-15300-095-0	9 430 611 003	1-15300-179-0	9 430 611 090	1-15300-274-5	9 430 612 544	1-15300-352-0	9 430 611 815
1-15300-098-0	9 430 610 884	1-15300-186-0	9 430 611 325	1-15300-274-6	9 430 612 545	1-15300-353-0	9 430 611 802
1-15300-102-1	9 430 610 943	1-15300-186-1	9 430 611 326	1-15300-276-0	9 430 611 441	1-15300-354-0	9 430 611 811
1-15300-103-0	9 430 610 909	1-15300-187-1	9 430 611 105	1-15300-277-0	9 430 611 478	1-15300-355-0	9 430 611 826
1-15300-103-1	9 430 610 910	1-15300-191-0	9 430 611 098	1-15300-279-0	9 430 612 704	1-15300-356-0	9 430 611 820
1-15300-104-0	9 430 610 824	1-15300-194-0	9 430 611 102	1-15300-279-1	9 430 613 059	1-15300-356-1	9 430 611 821
1-15300-104-1	9 430 610 825	1-15300-195-0	9 430 611 112	1-15300-281-0	9 430 612 555	1-15300-356-2	9 430 613 467
1-15300-104-2	9 430 610 826	1-15300-196-1	9 430 611 349	1-15300-281-1	9 430 613 281	1-15300-357-0	9 430 611 823
1-15300-105-1	9 430 610 858	1-15300-197-1	9 430 611 410	1-15300-283-1	9 430 612 511	1-15300-358-0	9 430 611 829
1-15300-106-0	9 430 610 855	1-15300-199-1	9 430 611 352	1-15300-285-0	9 430 613 022	1-15300-360-0	9 430 610 575
1-15300-106-1	9 430 610 856	1-15300-201-0	9 430 611 138	1-15300-285-1	9 430 611 587	1-15300-371-0	9 430 611 968
1-15300-107-0	9 430 610 912	1-15300-204-0	9 430 611 161	1-15300-286-0	9 430 612 769	1-15300-371-1	9 430 611 969
1-15300-107-1	9 430 610 913	1-15300-206-0	9 430 611 142	1-15300-287-0	9 430 611 490	1-15300-371-2	9 430 611 970
1-15300-108-0	9 430 610 930	1-15300-207-0	9 430 611 379	1-15300-288-0	9 430 612 995	1-15300-371-3	9 430 613 589
1-15300-109-0	9 430 610 931	1-15300-209-0	9 430 611 397	1-15300-288-1	9 430 611 494	1-15300-372-0	9 430 611 971
1-15300-111-0	9 430 610 918	1-15300-212-0	9 430 611 380	1-15300-288-2	9 430 612 994	1-15300-372-1	9 430 611 972
1-15300-111-1	9 430 612 969	1-15300-212-1	9 430 611 381	1-15300-289-0	9 430 611 497	1-15300-372-2	9 430 611 973
1-15300-112-1	9 430 610 924	1-15300-213-0	9 430 612 445	1-15300-289-1	9 430 612 993	1-15300-372-3	9 430 613 583
1-15300-114-0	9 430 610 926	1-15300-213-1	9 430 612 446	1-15300-291-0	9 430 611 499	1-15300-376-0	9 430 611 838
1-15300-117-1	9 430 610 937	1-15300-214-0	9 430 612 447	1-15300-291-1	9 430 611 500	1-15300-379-0	9 430 611 980
1-15300-118-1	9 430 610 938	1-15300-217-0	9 430 613 047	1-15300-293-0	9 430 611 501	1-15300-379-1	9 430 612 907
1-15300-119-0	9 430 610 932	1-15300-217-1	9 430 613 043	1-15300-294-0	9 430 611 594	1-15300-387-0	9 430 612 765
1-15300-120-0	9 430 610 944	1-15300-217-2	9 430 611 419	1-15300-294-1	9 430 611 595	1-15300-387-1	9 430 611 843
1-15300-120-1	9 430 610 095	1-15300-218-0	9 430 611 155	1-15300-295-0	9 430 611 596	1-15300-389-0	9 430 612 736
1-15300-120-2	9 430 610 945	1-15300-219-0	9 430 611 384	1-15300-295-1	9 430 611 597	1-15300-389-1	9 430 613 505
1-15300-128-0	9 430 610 956	1-15300-220-0	9 430 611 383	1-15300-296-0	9 430 612 989	1-15300-390-0	9 430 612 798
1-15300-128-1	9 430 610 957	1-15300-221-0	9 430 611 431	1-15300-299-0	9 430 611 508	1-15300-392-0	9 430 613 361
1-15300-133-1	9 430 612 977	1-15300-227-0	9 430 612 953	1-15300-303-0	9 430 611 515	1-15300-392-1	9 430 613 509
1-15300-134-0	9 430 610 976	1-15300-231-0	9 430 611 394	1-15300-303-1	9 430 612 986	1-15300-393-0	9 430 612 911
1-15300-134-1	9 430 610 977	1-15300-231-1	9 430 611 395	1-15300-305-0	9 430 611 800	1-15300-393-2	9 430 613 508
1-15300-135-0	9 430 610 978	1-15300-240-0	9 430 611 447	1-15300-305-1	9 430 611 801	1-15300-395-0	9 430 613 098







## ◀ IVECO

4798834	<b>0 460 416 036</b>	500323357	<b>0 460 424 147</b>	500355722	<b>0 460 426 317</b>	504045835	<b>0 432 133 779</b>
4800029	<b>0 432 291 655</b>	500323357	<b>0 986 440 066</b>	500361332	<b>0 460 424 142</b>	504047343	<b>0 460 414 235</b>
4800682	<b>0 460 413 002</b>	500323358	<b>0 460 404 090</b>	500361706	<b>0 460 424 197</b>	504047351	<b>0 460 426 357</b>
4803490	<b>0 460 414 042</b>	500323359	<b>0 460 424 146</b>	500362397	<b>0 460 416 090</b>	504047895	<b>0 445 120 036</b>
4803490	<b>0 460 416 042</b>	500323359	<b>0 986 440 065</b>	500363382	<b>0 414 700 002</b>	504047895	<b>0 986 435 507</b>
4804867	<b>0 460 413 004</b>	500323360	<b>0 460 424 148</b>	500363382	<b>0 986 441 102</b>	504048467	<b>0 460 424 269</b>
4804869	<b>0 460 414 024</b>	500323362	<b>0 460 424 152</b>	500366314	<b>0 445 020 006</b>	504049834	<b>0 460 424 307</b>
4808492	<b>0 460 494 189</b>	500323363	<b>0 460 424 164</b>	500366314	<b>0 986 437 502</b>	504050703	<b>0 460 424 266</b>
4810522	<b>0 432 291 648</b>	500324435	<b>0 414 700 002</b>	500367520	<b>0 414 700 004</b>	504050944	<b>0 460 424 268</b>
4810552	<b>0 432 291 648</b>	500324435	<b>0 986 441 102</b>	500371101	<b>0 445 120 011</b>	504052007	<b>0 460 424 285</b>
4812995	<b>0 460 414 067</b>	500324574	<b>0 460 404 096</b>	500371101	<b>0 986 435 506</b>	504052677	<b>0 460 424 283</b>
4812995	<b>0 986 440 028</b>	500324953	<b>0 460 413 020</b>	500371931	<b>0 460 494 477</b>	504053466	<b>0 460 426 374</b>
4814197	<b>0 460 414 054</b>	500324954	<b>0 460 413 016</b>	500371947	<b>0 445 020 008</b>	504053467	<b>0 460 424 284</b>
4814197	<b>0 986 440 027</b>	500324955	<b>0 460 413 019</b>	500371947	<b>0 986 437 318</b>	504053470	<b>0 460 426 357</b>
4817954	<b>0 460 414 040</b>	500324956	<b>0 460 413 021</b>	500377172	<b>0 460 494 476</b>	504053471	<b>0 460 424 268</b>
4820872	<b>0 460 426 171</b>	500324959	<b>0 460 414 182</b>	500377457	<b>0 460 413 023</b>	504054020	<b>0 460 424 274</b>
4820872	<b>0 986 440 076</b>	500324960	<b>0 460 414 187</b>	500380884	<b>0 414 700 003</b>	504054021	<b>0 432 291 492</b>
4824164	<b>0 432 291 604</b>	500324961	<b>0 460 414 177</b>	500380884	<b>0 986 441 112</b>	504054473	<b>0 460 423 011</b>
4824170	<b>0 432 291 605</b>	500324962	<b>0 460 414 176</b>	500383380	<b>0 460 424 148</b>	504054474	<b>0 460 423 012</b>
4830159	<b>0 460 414 078</b>	500324964	<b>0 460 416 089</b>	500384284	<b>0 445 120 002</b>	504054475	<b>0 460 423 008</b>
4830159	<b>0 986 440 032</b>	500324965	<b>0 460 413 018</b>	500384284	<b>0 986 435 501</b>	504054476	<b>0 460 424 296</b>
4835952	<b>0 432 291 581</b>	500324966	<b>0 460 414 186</b>	500385287	<b>0 432 133 782</b>	504054478	<b>0 460 424 298</b>
48456693	<b>0 986 430 332</b>	500324967	<b>0 460 414 181</b>	500385952	<b>0 460 424 220</b>	504054479	<b>0 460 424 297</b>
4848930	<b>0 460 424 075</b>	500324968	<b>0 460 414 175</b>	500389115	<b>0 460 413 023</b>	504055572	<b>0 460 423 024</b>
4851446	<b>0 432 291 595</b>	500324969	<b>0 460 424 179</b>	500390440	<b>0 432 131 626</b>	504055805	<b>0 445 120 028</b>
4851446	<b>0 432 291 655</b>	500324970	<b>0 460 424 182</b>	500390441	<b>0 432 133 780</b>	504057567	<b>0 460 426 371</b>
4896444	<b>0 445 120 007</b>	500324971	<b>0 460 426 297</b>	500390441	<b>0 432 133 838</b>	504057573	<b>0 460 424 286</b>
4896444	<b>0 986 435 508</b>	500324972	<b>0 460 426 296</b>	500399366	<b>0 460 424 227</b>	504060082	<b>0 460 424 284</b>
4896958	<b>0 445 020 007</b>	500325793	<b>0 460 426 168</b>	5005385953	<b>0 460 424 221</b>	504060082	<b>0 460 424 309</b>
4897040	<b>0 445 020 007</b>	500326169	<b>0 460 426 292</b>	503135250	<b>0 445 120 019</b>	504060083	<b>0 460 426 370</b>
4897271	<b>0 445 120 007</b>	500328286	<b>0 432 193 666</b>	503135250	<b>0 986 435 523</b>	504060084	<b>0 460 426 374</b>
4897271	<b>0 986 435 508</b>	500328971	<b>0 460 424 124</b>	503135269	<b>0 986 435 515</b>	504062436	<b>0 414 701 021</b>
4898821	<b>0 445 020 007</b>	500328971	<b>0 460 424 243</b>	503140183	<b>0 445 020 035</b>	504062438	<b>0 414 701 022</b>
4898921	<b>0 445 020 007</b>	500328971	<b>0 986 440 062</b>	503140728	<b>0 445 120 009</b>	504063050	<b>0 460 426 380</b>
5000789576	<b>0 432 291 672</b>	500328973	<b>0 460 424 125</b>	504002523	<b>0 460 494 484</b>	504063445	<b>0 460 423 003</b>
5001848034	<b>0 460 424 197</b>	500328973	<b>0 460 424 244</b>	504005534	<b>0 432 291 499</b>	504063450	<b>0 460 424 282</b>
5001852805	<b>0 460 494 476</b>	500328973	<b>0 986 440 063</b>	504018748	<b>0 445 010 098</b>	504063452	<b>0 460 424 306</b>
500301121	<b>0 432 193 798</b>	500329473	<b>0 460 424 136</b>	50402200	<b>0 414 700 005</b>	504063452	<b>0 460 424 343</b>
500301632	<b>0 432 291 519</b>	500329473	<b>0 986 440 064</b>	504026190	<b>0 460 423 015</b>	504063465	<b>0 432 133 775</b>
500302483	<b>0 432 193 818</b>	500329474	<b>0 460 424 137</b>	504026195	<b>0 460 424 306</b>	504063549	<b>0 460 424 302</b>
500303485	<b>0 432 117 002</b>	500329475	<b>0 460 424 180</b>	504028507	<b>0 460 424 270</b>	504063803	<b>0 460 424 275</b>
500304921	<b>0 414 701 006</b>	500329477	<b>0 460 424 177</b>	504029090	<b>0 460 424 308</b>	504065417	<b>0 460 426 381</b>
500304921	<b>0 986 441 103</b>	50032948	<b>0 460 494 470</b>	504030430	<b>0 460 424 250</b>	504066141	<b>0 986 435 506</b>
500305724	<b>0 460 494 466</b>	500331074	<b>0 414 701 013</b>	504035897	<b>0 460 424 295</b>	504066415	<b>0 460 414 232</b>
500305724	<b>0 986 440 163</b>	500331074	<b>0 986 441 113</b>	504036727	<b>0 460 413 028</b>	504066416	<b>0 460 414 233</b>
500306046	<b>0 460 494 464</b>	500334269	<b>0 432 193 641</b>	504041416	<b>0 460 424 300</b>	504066417	<b>0 460 414 234</b>
500307410	<b>0 460 424 165</b>	500338508	<b>0 460 424 147</b>	504041420	<b>0 460 423 007</b>	504067495	<b>0 460 424 316</b>
500307714	<b>0 432 291 509</b>	500338508	<b>0 986 440 066</b>	504042127	<b>0 460 424 282</b>	504068392	<b>0 460 424 328</b>
500307714	<b>0 432 291 514</b>	500338510	<b>0 460 424 146</b>	504042213	<b>0 460 423 006</b>	504068393	<b>0 460 424 314</b>
500311188	<b>0 460 426 302</b>	500338510	<b>0 986 440 065</b>	504042214	<b>0 460 424 299</b>	504068397	<b>0 460 424 345</b>
500313105	<b>0 445 120 002</b>	500338511	<b>0 460 424 148</b>	504042503	<b>0 460 424 249</b>	504068815	<b>0 460 424 304</b>
500313105	<b>0 986 435 501</b>	500339059	<b>0 414 701 006</b>	504042718	<b>0 460 424 280</b>	504071338	<b>0 460 423 013</b>
500317389	<b>0 432 291 504</b>	500339059	<b>0 986 441 103</b>	504044191	<b>0 460 424 252</b>	504071665	<b>0 460 426 384</b>
500320121	<b>0 460 404 097</b>	500350964	<b>0 432 193 517</b>	504044192	<b>0 460 494 483</b>	504072435	<b>0 460 424 307</b>
500321797	<b>0 432 193 666</b>	500351182	<b>0 460 426 316</b>	504044193	<b>0 460 424 248</b>	504073609	<b>0 460 424 333</b>



504073610	<b>0 460 424 346</b>	504112018	<b>0 460 424 316</b>	504191707	<b>0 460 424 412</b>	504342423	<b>0 445 010 545</b>
504073611	<b>0 460 424 329</b>	504113228	<b>0 460 424 306</b>	504191709	<b>0 460 424 432</b>	504361994	<b>0 460 424 379</b>
504073612	<b>0 460 424 330</b>	504113253	<b>0 445 120 036</b>	504193263	<b>0 444 022 001</b>	504365261	<b>0 444 022 019</b>
504073613	<b>0 460 424 334</b>	504113253	<b>0 986 435 507</b>	504193263	<b>0 986 44D 106</b>	504365261	<b>0 986 44D 106</b>
504073614	<b>0 460 424 321</b>	504113991	<b>0 460 424 349</b>	504194432	<b>0 445 120 092</b>	504368534	<b>0 460 424 279</b>
504073703	<b>0 432 131 626</b>	504116948	<b>0 432 291 491</b>	504197701	<b>0 460 424 389</b>	504371264	<b>0 445 117 025</b>
504077429	<b>0 460 426 370</b>	504117032	<b>0 460 424 307</b>	504200399	<b>0 444 010 008</b>	504373553	<b>0 460 424 491</b>
504077429	<b>0 460 426 414</b>	504117098	<b>0 460 423 013</b>	504200569	<b>0 460 426 451</b>	504374326	<b>0 444 022 021</b>
504078123	<b>0 460 424 337</b>	504117099	<b>0 460 424 283</b>	504201939	<b>0 460 414 268</b>	504374935	<b>0 460 424 482</b>
504078128	<b>0 460 424 339</b>	504117273	<b>0 445 120 079</b>	504205232	<b>0 460 426 465</b>	504374940	<b>0 460 424 478</b>
504078132	<b>0 460 426 394</b>	504124797	<b>0 460 426 452</b>	504208082	<b>0 460 424 403</b>	504374941	<b>0 460 424 473</b>
504078499	<b>0 432 133 774</b>	504124805	<b>0 460 426 456</b>	504208096	<b>0 460 414 265</b>	504374942	<b>0 460 424 469</b>
504078911	<b>0 460 426 378</b>	504124860	<b>0 460 426 458</b>	504213316	<b>0 414 703 013</b>	504374943	<b>0 460 424 481</b>
50407949	<b>0 460 426 395</b>	504125149	<b>0 432 133 764</b>	504214912	<b>0 460 424 388</b>	504374948	<b>0 460 424 477</b>
504079503	<b>0 460 426 419</b>	504125172	<b>0 460 426 381</b>	504218532	<b>0 460 424 275</b>	504374949	<b>0 460 424 479</b>
504079672	<b>0 460 426 388</b>	504125173	<b>0 460 426 384</b>	504218826	<b>0 460 424 430</b>	504374951	<b>0 460 424 483</b>
504079673	<b>0 460 426 389</b>	504125329	<b>0 414 703 008</b>	504219402	<b>0 460 424 425</b>	504374953	<b>0 460 424 476</b>
504080076	<b>0 432 131 623</b>	504125329	<b>0 986 441 026</b>	504222161	<b>0 460 424 275</b>	504385557	<b>0 445 116 019</b>
504080487	<b>0 414 703 008</b>	504126562	<b>0 460 426 410</b>	504222166	<b>0 460 426 476</b>	504386427	<b>0 445 110 435</b>
504080487	<b>0 986 441 026</b>	504128307	<b>0 445 120 075</b>	504226098	<b>0 460 424 349</b>	504387474	<b>0 460 424 491</b>
504082373	<b>0 414 703 004</b>	504128307	<b>0 986 435 530</b>	504226099	<b>0 460 423 013</b>	504387476	<b>0 460 424 491</b>
504082373	<b>0 986 441 025</b>	504128354	<b>0 986 441 027</b>	504242095	<b>0 432 133 763</b>	504389548	<b>0 445 110 418</b>
504085601	<b>0 460 424 327</b>	504128987	<b>0 460 424 295</b>	504245256	<b>0 445 010 181</b>	5090725	<b>0 432 291 494</b>
504086469	<b>0 445 120 036</b>	504128987	<b>0 460 424 402</b>	504245256	<b>0 986 437 085</b>	5095919	<b>0 460 413 031</b>
504086469	<b>0 986 435 507</b>	504129021	<b>0 460 426 447</b>	504246241	<b>0 460 426 477</b>	5096735	<b>0 460 423 029</b>
504086528	<b>0 432 133 771</b>	504129605	<b>0 460 426 457</b>	504246314	<b>0 460 424 417</b>	5096736	<b>0 460 423 030</b>
504087263	<b>0 460 426 426</b>	504129606	<b>0 460 426 459</b>	504246317	<b>0 460 424 409</b>	5096737	<b>0 460 424 372</b>
504087264	<b>0 460 426 415</b>	504129607	<b>0 460 426 453</b>	504246318	<b>0 460 424 410</b>	5096738	<b>0 460 424 373</b>
504087265	<b>0 460 426 425</b>	504129609	<b>0 460 426 455</b>	504246319	<b>0 460 424 408</b>	5096739	<b>0 460 424 370</b>
504088755	<b>0 445 110 273</b>	504130017	<b>0 460 426 370</b>	504246320	<b>0 460 424 414</b>	5096807	<b>0 432 291 490</b>
504088755	<b>0 986 435 165</b>	504132378	<b>0 414 703 004</b>	504246340	<b>0 460 426 481</b>	5801382396	<b>0 445 020 175</b>
504088823	<b>0 445 110 248</b>	504132378	<b>0 986 441 025</b>	504247893	<b>0 460 424 398</b>	5801382396	<b>0 445 120 075</b>
504088823	<b>0 986 435 163</b>	504134866	<b>0 460 424 413</b>	504251949	<b>0 460 424 424</b>	5801439052	<b>0 445 010 181</b>
504091504	<b>0 445 120 054</b>	504135580	<b>0 460 416 105</b>	50425195	<b>0 460 414 267</b>	5801439067	<b>0 445 010 222</b>
504091505	<b>0 445 120 057</b>	504135584	<b>0 460 416 103</b>	504251950	<b>0 460 414 267</b>	5801469103	<b>0 445 010 300</b>
504091525	<b>0 432 133 771</b>	504145103	<b>0 444 022 001</b>	504255185	<b>0 445 120 157</b>	5801470100	<b>0 445 020 508</b>
504092399	<b>0 460 424 367</b>	504154922	<b>0 986 441 027</b>	504255636	<b>0 460 424 423</b>	5801540211	<b>0 445 116 059</b>
504092400	<b>0 460 423 027</b>	504164563	<b>0 432 193 447</b>	504255638	<b>0 460 424 416</b>	61315024	<b>0 432 191 818</b>
504093216	<b>0 445 120 079</b>	504166183	<b>0 460 424 401</b>	504256636	<b>0 460 424 423</b>	61316336	<b>0 432 191 818</b>
504095664	<b>0 445 020 046</b>	504166342	<b>0 460 423 013</b>	504275234	<b>0 432 193 433</b>	61317616	<b>0 432 191 818</b>
504096996	<b>0 460 426 412</b>	504171001	<b>0 460 426 499</b>	504277094	<b>0 460 424 441</b>	61319197	<b>0 432 191 731</b>
504096998	<b>0 460 426 411</b>	504173550	<b>0 460 424 386</b>	504281571	<b>0 460 424 442</b>	61320138	<b>0 432 191 731</b>
504097006	<b>0 460 424 351</b>	504174452	<b>0 460 426 461</b>	504287060	<b>0 460 424 436</b>	71724118	<b>0 986 435 506</b>
504097007	<b>0 460 424 349</b>	504177968	<b>0 460 424 275</b>	5042870607	<b>0 460 424 435</b>	71791186	<b>0 986 430 527</b>
504097060	<b>0 460 426 410</b>	504180104	<b>0 460 426 470</b>	504287069	<b>0 414 703 004</b>	771354	<b>0 432 297 034</b>
504097332	<b>0 445 010 137</b>	504181063	<b>0 460 414 270</b>	504287070	<b>0 414 703 008</b>	771354	<b>0 986 430 144</b>
504098451	<b>0 460 424 333</b>	504181064	<b>0 460 424 404</b>	504287071	<b>0 414 703 010</b>	7735577	<b>0 460 484 051</b>
504098452	<b>0 460 424 346</b>	504181065	<b>0 460 424 445</b>	504287108	<b>0 414 703 013</b>	7735579	<b>0 460 494 304</b>
504099014	<b>0 986 441 027</b>	504181066	<b>0 460 414 269</b>	504296671	<b>0 445 010 222</b>	7778146	<b>0 432 217 274</b>
504099847	<b>0 445 020 040</b>	504181950	<b>0 460 424 429</b>	504303916	<b>0 460 424 466</b>	7778146	<b>0 986 430 525</b>
504100287	<b>0 414 700 006</b>	504188076	<b>0 445 020 093</b>	504307525	<b>0 460 426 480</b>	8023957	<b>0 460 426 292</b>
504100484	<b>0 460 424 361</b>	504188478	<b>0 460 424 405</b>	504330618	<b>0 460 424 460</b>	8052934	<b>0 445 120 269</b>
504103774	<b>0 460 424 406</b>	504189428	<b>0 460 426 446</b>	504330619	<b>0 460 424 464</b>	8096535	<b>0 432 117 002</b>
504106508	<b>0 414 703 010</b>	504189447	<b>0 460 424 393</b>	50433062	<b>0 460 424 459</b>	8097193	<b>0 460 404 097</b>
504112017	<b>0 460 424 275</b>	504190005	<b>0 460 424 383</b>	504341488	<b>0 445 116 019</b>	8097332	<b>0 460 424 148</b>





04148899	<b>0 432 291 644</b>	04280367	<b>0 432 191 399</b>	211 2633	<b>0 432 191 376</b>	415 8546	<b>0 432 291 752</b>
04149713	<b>0 432 291 633</b>	04280368	<b>0 432 193 546</b>	211 2634	<b>0 432 191 353</b>	417 8021	<b>0 432 191 623</b>
04150926	<b>0 432 291 669</b>	04289311	<b>0 445 120 066</b>	211 2635	<b>0 432 191 252</b>	417 8022	<b>0 432 191 625</b>
04153182	<b>0 432 191 798</b>	04290986	<b>0 445 120 066</b>	211 2636	<b>0 432 191 367</b>	417 8023	<b>0 432 191 624</b>
04153605	<b>0 432 191 787</b>	04290987	<b>0 445 120 067</b>	211 2640	<b>0 432 191 377</b>	417 8024	<b>0 432 191 627</b>
04154134	<b>0 432 191 787</b>	04504488	<b>0 445 120 234</b>	211 2644	<b>0 432 191 378</b>	417 9470	<b>0 432 193 791</b>
04154141	<b>0 432 191 798</b>	04504666	<b>0 445 124 001</b>	211 2645	<b>0 432 191 379</b>	417 9983	<b>0 432 191 605</b>
04154143	<b>0 432 191 787</b>	04902255	<b>0 445 120 064</b>	211 2681	<b>0 432 191 345</b>	418 4965	<b>0 432 291 644</b>
04157216	<b>0 432 291 753</b>	04902255	<b>0 986 435 529</b>	211 2706	<b>0 414 750 004</b>	418 5578	<b>0 432 291 591</b>
04157645	<b>0 432 191 752</b>	04902525	<b>0 445 120 074</b>	211 2707	<b>0 414 750 003</b>	418 6695	<b>0 432 291 553</b>
04158138	<b>0 432 191 752</b>	04902825	<b>0 445 120 064</b>	211 2835	<b>0 432 191 346</b>	422 1425	<b>0 432 131 795</b>
04158546	<b>0 432 191 752</b>	04902825	<b>0 986 435 529</b>	211 2862	<b>0 432 191 328</b>	422 4446	<b>0 432 131 696</b>
04158546	<b>0 432 291 752</b>	04909357	<b>0 445 124 008</b>	211 2926	<b>0 432 191 324</b>	422 4523	<b>0 432 131 695</b>
04178021	<b>0 432 191 623</b>	04909358	<b>0 445 124 007</b>	211 2949	<b>0 432 191 287</b>	422 6621	<b>0 432 131 659</b>
04178022	<b>0 432 191 625</b>	077 1355	<b>0 432 297 034</b>	211 2955	<b>0 432 191 325</b>	422 6624	<b>0 432 131 658</b>
04178023	<b>0 432 191 624</b>	08122172	<b>0 432 291 807</b>	211 2957	<b>0 432 191 327</b>	423 0141	<b>0 432 191 712</b>
04178024	<b>0 432 191 627</b>	08122172	<b>0 986 430 124</b>	211 2960	<b>0 432 191 326</b>	423 1554	<b>0 432 191 582</b>
04179470	<b>0 432 193 791</b>	08122175	<b>0 432 291 753</b>	211 2967	<b>0 432 191 323</b>	423 2066	<b>0 432 191 568</b>
04179983	<b>0 432 191 605</b>	08122175	<b>0 986 430 067</b>	211 2994	<b>0 432 193 498</b>	423 2373	<b>0 432 291 753</b>
04184965	<b>0 432 291 644</b>	08122176	<b>0 432 291 752</b>	211 3000	<b>0 432 191 313</b>	423 2434	<b>0 432 191 399</b>
04185578	<b>0 432 291 591</b>	1181 50 20 00	<b>0 432 207 006</b>	211 3007	<b>0 432 191 245</b>	423 2434	<b>0 432 227 035</b>
04186695	<b>0 432 291 553</b>	12038849	<b>0 432 291 827</b>	211 3090	<b>0 432 191 292</b>	423 3015	<b>0 432 191 487</b>
04221425	<b>0 432 131 795</b>	12136792	<b>0 432 390 019</b>	211 3133	<b>0 432 193 486</b>	423 3067	<b>0 432 191 479</b>
04224446	<b>0 432 131 696</b>	12153035	<b>0 432 287 007</b>	211 3547	<b>0 432 193 450</b>	423 3892	<b>0 432 191 330</b>
04224523	<b>0 432 131 695</b>	12153044	<b>0 432 291 029</b>	211 3645	<b>0 432 193 446</b>	423 4349	<b>0 432 191 312</b>
04226621	<b>0 432 131 659</b>	12153047	<b>0 432 291 701</b>	211 3775	<b>0 432 193 498</b>	424 0720	<b>0 432 291 497</b>
04226624	<b>0 432 131 658</b>	12153048	<b>0 432 291 731</b>	212 6992	<b>0 432 191 655</b>	424 0725	<b>0 432 291 498</b>
04230141	<b>0 432 191 712</b>	12153052	<b>0 432 291 711</b>	212 6992	<b>0 986 430 490</b>	426 0140	<b>0 432 131 649</b>
04231554	<b>0 432 191 582</b>	12153055	<b>0 432 291 686</b>	212 6993	<b>0 432 191 654</b>	426 0142	<b>0 432 131 648</b>
04232066	<b>0 432 191 568</b>	12153057	<b>0 432 291 671</b>	214 5079	<b>0 432 291 807</b>	426 0506	<b>0 432 131 647</b>
04232373	<b>0 432 291 753</b>	12153059	<b>0 432 291 645</b>	214 5079	<b>0 986 430 124</b>	426 0889	<b>0 432 131 637</b>
04232434	<b>0 432 191 399</b>	12270158	<b>0 432 291 569</b>	214 7859	<b>0 432 291 782</b>	426 1447	<b>0 432 131 635</b>
04232434	<b>0 432 227 035</b>	12270162	<b>0 432 291 573</b>	223 3085	<b>0 432 291 753</b>	426 1448	<b>0 432 131 638</b>
04233015	<b>0 432 191 487</b>	12270525	<b>0 432 291 552</b>	223 3085	<b>0 986 430 067</b>	426 1449	<b>0 432 131 634</b>
04233067	<b>0 432 191 479</b>	12272011	<b>0 460 424 098</b>	223 3272	<b>0 432 291 752</b>	426 2056	<b>0 414 755 016</b>
04233892	<b>0 432 191 330</b>	12272019	<b>0 460 426 220</b>	293 4455	<b>0 432 237 006</b>	426 2105	<b>0 432 131 627</b>
04234349	<b>0 432 191 312</b>	12277366	<b>0 432 131 757</b>	302 8857	<b>0 460 414 063</b>	426 2581	<b>0 432 131 618</b>
04240720	<b>0 432 291 497</b>	12279517	<b>0 432 191 438</b>	337 2161	<b>0 432 227 027</b>	426 2582	<b>0 432 131 619</b>
04240725	<b>0 432 291 498</b>	12279802	<b>0 432 291 520</b>	400 7565	<b>0 432 237 006</b>	426 2583	<b>0 432 131 620</b>
04260140	<b>0 432 131 649</b>	12314246	<b>0 432 131 670</b>	401 4333	<b>0 432 191 568</b>	426 2585	<b>0 432 131 614</b>
04260142	<b>0 432 131 648</b>	12314694	<b>0 432 131 666</b>	401 5876	<b>0 432 237 006</b>	426 3302	<b>0 432 131 613</b>
04260506	<b>0 432 131 647</b>	12316782	<b>0 432 131 642</b>	412 3891	<b>0 445 020 507</b>	426 4634	<b>0 432 131 611</b>
04260889	<b>0 432 131 637</b>	211 1696	<b>0 432 191 539</b>	414 3814	<b>0 432 291 699</b>	427 1760	<b>0 432 193 596</b>
04261447	<b>0 432 131 635</b>	211 1697	<b>0 432 191 538</b>	414 8899	<b>0 432 291 644</b>	428 0367	<b>0 432 191 399</b>
04261448	<b>0 432 131 638</b>	211 1987	<b>0 432 191 539</b>	414 9713	<b>0 432 291 633</b>	428 0368	<b>0 432 193 546</b>
04261449	<b>0 432 131 634</b>	211 1988	<b>0 432 191 538</b>	415 0926	<b>0 432 291 669</b>	428 9311	<b>0 445 120 066</b>
04262056	<b>0 414 755 016</b>	211 2351	<b>0 432 191 411</b>	415 3182	<b>0 432 191 798</b>	429 0986	<b>0 445 120 066</b>
04262105	<b>0 432 131 627</b>	211 2380	<b>0 432 191 452</b>	415 3605	<b>0 432 191 787</b>	429 0987	<b>0 445 120 067</b>
04262581	<b>0 432 131 618</b>	211 2489	<b>0 432 191 424</b>	415 4134	<b>0 432 191 787</b>	450 4488	<b>0 445 120 234</b>
04262582	<b>0 432 131 619</b>	211 2598	<b>0 432 193 482</b>	415 4141	<b>0 432 191 798</b>	450 4666	<b>0 445 124 001</b>
04262583	<b>0 432 131 620</b>	211 2604	<b>0 432 191 380</b>	415 4143	<b>0 432 191 787</b>	490 2255	<b>0 445 120 064</b>
04262585	<b>0 432 131 614</b>	211 2624	<b>0 432 191 373</b>	415 7216	<b>0 432 291 753</b>	490 2255	<b>0 986 435 529</b>
04263302	<b>0 432 131 613</b>	211 2625	<b>0 432 191 375</b>	415 7645	<b>0 432 191 752</b>	490 2525	<b>0 445 120 074</b>
04264634	<b>0 432 131 611</b>	211 2626	<b>0 432 191 374</b>	415 8138	<b>0 432 191 752</b>	490 2825	<b>0 445 120 064</b>
04271760	<b>0 432 193 596</b>	211 2627	<b>0 432 191 369</b>	415 8546	<b>0 432 191 752</b>	490 2825	<b>0 986 435 529</b>





















◀ MERCEDES-BENZ

629 070 02 87	<b>0 445 115 065</b>	647 070 01 87	<b>0 445 110 162</b>	MD060177	<b>9 460 610 032</b>	MD354508	<b>9 460 613 234</b>
639 070 02 87	<b>0 445 110 267</b>	647 070 01 87	<b>0 986 435 110</b>	MD060178	<b>9 460 610 033</b>	MD362557	<b>9 460 613 248</b>
640 070 06 87	<b>0 445 110 166</b>	647 070 01 87 0080	<b>0 986 435 110</b>	MD063907	<b>9 460 610 611</b>	ME015190	<b>9 430 612 551</b>
640 070 06 87	<b>0 986 435 117</b>	648 070 00 01	<b>0 986 437 364</b>	MD067627	<b>9 460 610 037</b>	ME015202	<b>9 430 612 563</b>
640 070 07 01	<b>0 986 437 368</b>	648 070 00 87	<b>0 445 110 128</b>	MD067629	<b>9 460 610 039</b>	ME016303	<b>9 430 612 410</b>
640 070 07 01 0080	<b>0 986 437 368</b>	648 070 01 87	<b>0 445 110 155</b>	MD071530	<b>9 460 610 041</b>	ME016305	<b>9 430 613 291</b>
640 070 07 87	<b>0 445 110 166</b>	648 070 01 87	<b>0 986 435 135</b>	MD071531	<b>9 460 610 042</b>	ME016315	<b>9 430 610 102</b>
640 070 07 87	<b>0 986 435 117</b>	648 070 01 87 0080	<b>0 986 435 135</b>	MD071533	<b>9 460 610 290</b>	ME016317	<b>9 430 613 315</b>
640 070 07 87	<b>0 986 435 118</b>	648 070 02 01	<b>0 986 437 366</b>	MD071534	<b>9 460 610 003</b>	ME016655	<b>9 430 612 516</b>
640 070 07 87 0080	<b>0 986 435 118</b>	648 070 02 01 0080	<b>0 986 437 366</b>	MD071539	<b>9 460 610 043</b>	ME016983	<b>9 430 612 507</b>
640 070 11 87	<b>0 445 110 323</b>	648 070 02 87	<b>0 445 110 176</b>	MD073632	<b>9 460 610 422</b>	ME016986	<b>9 430 612 540</b>
640 070 12 87	<b>0 445 110 377</b>	648 070 02 87	<b>0 986 435 111</b>	MD074540	<b>9 430 610 009</b>	ME016987	<b>9 430 613 057</b>
642 070 00 01	<b>0 986 437 363</b>	648 070 02 87 0080	<b>0 986 435 111</b>	MD074540	<b>9 430 610 399</b>	ME017739	<b>9 430 612 389</b>
642 070 03 01	<b>0 986 437 363</b>	648 070 03 87	<b>0 445 110 193</b>	MD074608	<b>9 460 610 078</b>	ME017801	<b>9 430 610 046</b>
642 070 03 01 0080	<b>0 986 437 363</b>	660 070 00 01	<b>0 445 010 273</b>	MD076156	<b>9 460 610 168</b>	ME019714	<b>9 430 612 387</b>
642 070 04 87	<b>0 445 115 016</b>	660 070 01 01	<b>0 986 437 365</b>	MD076157	<b>9 460 610 612</b>	ME035748	<b>9 430 610 971</b>
642 070 05 87	<b>0 445 115 026</b>	660 070 01 01 0080	<b>0 986 437 365</b>	MD077258	<b>9 460 610 079</b>	ME035966	<b>9 430 612 971</b>
642 070 05 87	<b>0 986 435 355</b>	660 070 01 87	<b>0 445 110 022</b>	MD077642	<b>9 460 610 046</b>	ME036290	<b>9 430 611 295</b>
642 070 09 01	<b>0 445 010 360</b>	660 070 01 87	<b>0 445 110 023</b>	MD077643	<b>9 460 610 096</b>	ME046101	<b>9 430 611 013</b>
642 070 10 87	<b>0 445 115 055</b>	660 070 01 87	<b>0 986 435 008</b>	MD077708	<b>9 460 610 169</b>	ME047880	<b>9 430 611 464</b>
642 070 11 01	<b>0 445 010 363</b>	660 070 01 87 0080	<b>0 986 435 008</b>	MD078302	<b>9 460 610 044</b>	ME056265	<b>9 430 610 939</b>
642 070 11 87	<b>0 445 116 025</b>	660 070 03 87	<b>0 445 110 302</b>	MD092628	<b>9 460 610 219</b>	ME056275	<b>9 430 613 826</b>
642 070 11 87	<b>0 445 116 026</b>	660 070 04 01	<b>0 445 010 348</b>	MD103301	<b>9 430 610 154</b>	ME056542	<b>9 430 611 092</b>
642 070 12 87	<b>0 445 116 027</b>	664 070 00 01	<b>0 445 010 344</b>	MD103301CKD	<b>9 430 610 154</b>	ME059532	<b>9 430 610 882</b>
642 070 13 01	<b>0 445 010 322</b>	664 070 02 01	<b>0 445 010 344</b>	MD104233	<b>9 460 610 225</b>	ME059621	<b>9 430 610 106</b>
642 070 13 87	<b>0 445 115 063</b>	664 070 02 01	<b>0 986 437 362</b>	MD104235	<b>9 460 610 227</b>	ME066499	<b>9 430 613 770</b>
642 070 13 87	<b>0 986 435 355</b>	664 070 02 01 0080	<b>0 986 437 362</b>	MD104236	<b>9 460 610 228</b>	ME066931	<b>9 430 613 777</b>
642 070 14 87	<b>0 445 115 059</b>	668 070 02 87	<b>0 445 110 014</b>	MD110299	<b>9 460 610 197</b>	ME070762	<b>9 430 611 396</b>
642 070 15 87	<b>0 445 115 061</b>	668 070 02 87	<b>0 445 110 015</b>	MD113131	<b>9 460 610 247</b>	ME072662	<b>9 430 612 936</b>
642 070 18 87	<b>0 986 435 355</b>	668 070 02 87	<b>0 986 435 005</b>	MD119828	<b>9 460 610 322</b>	ME075405	<b>9 430 611 898</b>
646 070 01 01	<b>0 986 437 364</b>	668 070 03 01	<b>0 445 010 268</b>	MD155249	<b>9 460 611 395</b>	ME075406	<b>9 430 612 791</b>
646 070 01 01 0080	<b>0 986 437 364</b>	668 070 03 01	<b>0 986 437 009</b>	MD155256	<b>9 460 610 580</b>	ME075408	<b>9 430 611 904</b>
646 070 01 87	<b>0 445 110 137</b>	668 070 03 01 0080	<b>0 986 437 009</b>	MD155257	<b>9 460 610 625</b>	ME075409	<b>9 430 611 893</b>
646 070 02 87	<b>0 445 110 139</b>	668 070 06 87	<b>0 445 110 014</b>	MD155261	<b>9 460 611 276</b>	ME075518	<b>9 430 610 513</b>
646 070 02 87	<b>0 986 435 107</b>	668 070 06 87	<b>0 986 435 005</b>	MD167348	<b>9 460 610 523</b>	ME075530	<b>9 430 611 913</b>
646 070 02 87 0080	<b>0 986 435 107</b>	668 070 08 87	<b>0 445 110 089</b>	MD171997	<b>9 460 610 508</b>	ME075761	<b>9 430 612 792</b>
646 070 04 01	<b>0 986 437 364</b>	668 070 08 87	<b>0 986 435 033</b>	MD171998	<b>9 460 610 528</b>	ME076087	<b>9 430 611 126</b>
646 070 04 01 0080	<b>0 986 437 364</b>	668 070 08 87 0080	<b>0 986 435 033</b>	MD196607	<b>9 430 610 179</b>	ME076205	<b>9 430 611 130</b>
646 070 04 87	<b>0 445 110 263</b>	668 070 09 87	<b>0 445 110 115</b>	MD301925	<b>9 460 610 643</b>	ME076742	<b>9 430 613 029</b>
646 070 04 87	<b>0 986 435 115</b>	668 070 09 87	<b>0 986 435 049</b>	MD301928	<b>9 460 610 779</b>	ME076952	<b>9 430 612 785</b>
646 070 04 87	<b>0 986 435 116</b>	668 070 09 87 0080	<b>0 986 435 049</b>	MD304868	<b>9 460 610 640</b>	ME076953	<b>9 430 612 776</b>
646 070 04 87 0080	<b>0 986 435 115</b>	668 070 11 87	<b>0 445 110 197</b>	MD304869	<b>9 460 610 871</b>	ME080082	<b>9 430 612 412</b>
646 070 04 87 0080	<b>0 986 435 116</b>	668 070 11 87	<b>0 986 435 059</b>	MD304881	<b>9 460 610 663</b>	ME080329	<b>9 430 613 317</b>
646 070 07 87	<b>0 445 110 237</b>	668 070 12 87	<b>0 445 110 195</b>	MD306838	<b>9 460 610 692</b>	ME080371	<b>9 430 612 492</b>
646 070 07 87	<b>0 986 435 139</b>	668 070 12 87	<b>0 986 435 057</b>	MD306840	<b>9 460 610 693</b>	ME080501	<b>9 430 612 531</b>
646 070 11 87	<b>0 445 115 032</b>	668 070 12 87 0080	<b>0 986 435 057</b>	MD306845	<b>9 460 610 694</b>	ME086541	<b>9 430 612 436</b>
646 070 11 87	<b>0 986 435 356</b>			MD311775	<b>9 460 611 605</b>	ME091275	<b>9 430 613 773</b>
646 070 12 87	<b>0 445 110 294</b>			MD311782	<b>9 460 610 908</b>	ME093171	<b>9 430 611 894</b>
646 070 12 87	<b>0 986 435 159</b>			MD311783	<b>9 460 610 909</b>	ME093732	<b>9 430 611 922</b>
646 070 14 87	<b>0 445 115 068</b>			MD311784	<b>9 460 610 671</b>	ME094539	<b>9 430 613 612</b>
646 070 14 87	<b>0 986 435 356</b>			MD313057	<b>9 460 610 724</b>	ME121204	<b>9 430 611 905</b>
646 070 15 87	<b>0 986 435 356</b>			MD323061	<b>9 460 610 924</b>	ME121216	<b>9 430 611 906</b>
647 070 00 87	<b>0 445 110 191</b>	<b>MITSUBISHI</b>		MD323852	<b>9 460 610 926</b>	ME121324	<b>9 430 611 917</b>
647 070 00 87	<b>0 986 435 114</b>			MD342303	<b>9 460 611 401</b>	ME131608	<b>9 430 611 965</b>
647 070 00 87 0080	<b>0 986 435 114</b>	MD050052	<b>9 460 610 002</b>	MD347795	<b>9 460 614 159</b>	ME150595	<b>9 430 611 892</b>
		MD050590	<b>9 430 610 005</b>				
		MD060173	<b>9 460 610 411</b>				



ME150796	9 430 611 910	3436101010	9 430 612 459	000 010 5851	0 432 291 510	12277366	0 432 131 757
ME150862	9 430 613 899	4D55	9 460 610 004	000 010 60 51	0 432 191 514	12279802	0 432 291 520
ME161080	9 430 611 621	4D56	9 460 610 205	000 017 84 21	0 432 207 006	12314246	0 432 131 670
ME161177	9 430 611 902	4D56	9 460 610 207	001 010 08 51	0 432 191 467	12314259	0 432 131 670
ME161389	9 430 611 909	4D56	9 460 610 234	001 010 21 51	0 432 191 469	12314694	0 432 131 666
ME190297	0 470 504 027	4D56	9 460 610 235	001 010 48 51	0 432 191 427	12316782	0 432 131 642
ME190513	9 460 614 418	4D56	9 460 610 236	001 010 55 51	0 432 191 366	14619415	0 460 424 103
ME190514	9 460 614 419	4D56	9 460 610 237	001 010 70 51	0 432 191 387	3 0530 01 0 0007	0 432 291 827
ME190515	9 460 614 420	4D56	9 460 610 238	001 010 78 51	0 432 191 251	6 0530 20 0 0017	0 432 287 007
ME190694	9 430 613 413	4D56	9 460 610 239	001 010 86 51	0 432 191 362	6 0530 20 0 0049	0 432 291 029
ME190861	9 430 613 409	4D56	9 460 610 296	001 017 39 21	0 432 390 001	6 0530 20 0 0053	0 432 291 756
ME191198	9 430 613 543	4D56	9 460 610 300	001 017 44 21	0 432 206 010	6 0530 20 0 0055	0 432 291 701
ME191379	9 430 613 739	4D56	9 460 610 301	001 017 52 21	0 432 226 004	6 0530 20 0 0060	0 432 291 711
ME192242	0 445 020 027	4D56	9 460 610 303	002 017 51 21	0 432 291 524	6 0530 20 0 0066	0 432 291 686
ME192736	0 445 120 047	4D56	9 460 610 318	002 017 71 21	0 432 231 674	6 0530 20 0 0068	0 432 291 671
ME193960	0 445 020 049	4D65	9 430 610 050	004 017 50 21	0 432 131 707	6 0530 20 0 0070	0 432 291 671
ME193983	0 445 120 091	6D15	9 430 610 842	004 017 50 21	0 986 430 091	6 0530 20 0 0073	0 432 291 645
ME200204	9 430 610 420	6D22T	9 430 611 092	004 017 51 21	0 432 131 706	7002581C1	0 445 120 327
ME200527	9 430 610 422			005 017 34 21	0 432 131 645	9 0520 07 4 9004	0 460 424 088
ME201115	9 460 614 156			005 070 62 01	0 414 799 010	9 0520 07 4 9007	0 460 424 102
ME201683	9 460 610 755	<b>MITSUBISHI FUSO TRUCK &amp; BUS CO</b>		005 070 96 01	0 414 799 009	9 0520 07 4 9007	0 460 424 113
ME202093	9 460 611 722	ME194299	0 445 120 073	005 070 96 01	0 986 445 110	9 0520 07 4 9007	0 460 424 114
ME202411	9 460 611 852	ME225083	0 445 020 050	05235920	0 414 799 011	9 0520 07 4 9008	0 460 424 103
ME202614	9 460 613 827			23528305	0 432 191 423	9 0520 07 4 9015	0 460 424 109
ME202631	9 460 611 404			535 073 00 00/1	0 414 799 023	9 0520 07 4 9015	0 460 424 245
ME202651	9 460 613 861	ME225416	0 445 120 072	550 010 16 51	0 432 231 031	9 0520 07 4 9016	0 460 424 113
ME203712	9 430 610 242	ME355793	0 445 120 058	555 010 02 51	0 432 231 046	9 0520 07 4 9017	0 460 424 116
ME203961	9 430 613 989	ME357450	0 445 020 074	555 010 06 51	0 432 231 046	9 0520 07 4 9018	0 460 424 115
ME204431	9 460 614 417	ME357728	0 445 120 109	555 010 07 51	0 432 231 762	9 0520 07 4 9020	0 460 424 138
ME219131	9 430 613 524	ME994980	9 430 610 154	555 010 24 51	0 432 231 696	9 0520 07 4 9020	0 986 440 228
ME221816	0 445 020 028	<b>MITSUBISHI HEAVY</b>		555 010 26 51	0 432 231 694	9 0520 07 4 9021	0 460 424 128
ME221915	0 445 020 029	ME047880	9 430 611 464	555 017 04 21	0 432 231 734	9 0520 07 4 9022	0 460 424 129
ME222914	0 445 120 048	ME080371	9 430 612 492	555 101 18 51	0 432 231 734	9 0520 07 4 9023	0 460 424 131
ME223002	0 445 120 049	0423401012	9 430 615 047	580 010 10 51	0 432 390 011	9 0520 07 4 9024	0 460 424 130
ME225083	0 445 020 050			583 010 01 51	0 432 490 008	9 0520 07 4 9025	0 460 424 149
ME225190	0 445 120 090	32A6500460	F 01G 09W OEL	587 010 02 51	0 432 490 007	9 0520 07 4 9029	0 460 424 181
ME304881	9 460 610 663	32G6100010	0 445 120 126			9 052 007 4903	0 460 424 198
ME306845	9 460 610 694	32G6100300	0 445 020 083			9 0520 07 4 9030	0 460 424 222
ME351393	F 01G 000 000					9 0520 07 4 9031	0 460 424 115
ME355360	0 445 020 042					9 0520 07 4 9031	0 460 424 194
ME440089	9 430 613 825	<b>MTU</b>		<b>MWM-DIESEL</b>			
ME440837	9 430 613 530	RX53507300001	0 986 445 115	0 0837 90 4 0049	0 432 291 827	9 0520 07 4 9031	0 460 424 211
ME705431	9 430 615 061	R 005 070 96 01	0 986 445 110	0 1173 41 3 0001	0 432 191 552	9 0520 07 4 9033	0 460 424 194
ME705443	9 430 615 063	R0060704101	0 986 445 114	0 1173 41 3 0001	0 432 291 552	9 0520 07 4 9033	0 460 424 211
MN128542	9 430 613 643	X53 507 500 006	0 432 191 232	12038849	0 432 291 827	9 0520 07 4 9034	0 460 424 210
MN980235	0 414 720 454	X53 507 500 010	0 432 191 228	12136792	0 432 390 019	9 0520 07 4 9035	0 460 424 216
0423400060	9 430 611 771	X53 507 500 012	0 432 191 229	12153055	0 432 291 686	9 0520 07 4 9035	0 460 424 245
0423410060	9 430 611 772	X54 407 500 010	0 445 124 017	12270158	0 432 291 569	9 0520 07 4 9036	0 460 424 222
171997	9 460 610 508	X57 507 300 005	0 445 020 139	12270162	0 432 291 573	9 0520 07 4 9036	0 460 424 223
3096131010	9 430 610 764	X57 507 500 0024	0 445 120 229	12270525	0 432 291 552	9 0520 07 4 9037	0 460 424 228
3096199090	9 430 610 745	X57 507 500 024	0 445 120 229	12272011	0 460 424 098	9 0520 07 4 9042	0 460 424 216
3126130020	9 430 613 767	000 010 27 51	0 432 191 584	12272017	0 460 426 220	9 0520 07 4 9055	0 460 424 369
3126169053	9 430 610 761	000 010 33 51	0 432 191 553	12272019	0 460 426 220	9 0520 07 6 9007	0 460 426 250
3129642102	9 430 610 768	000 010 43 51	0 432 191 503	12277057	0 432 131 757	9 0520 07 6 9008	0 460 426 259
3129653401	9 430 610 777					9 0520 07 6 9008	0 460 426 331
						9 0520 07 6 9010	0 460 426 279





16600 89TA4	9 430 610 504
16600 89TA5	9 430 612 656
16600 9C600	0 432 117 001
16600 9S000	9 430 613 876
16600 9S025	9 430 613 801
16600 90019	9 430 610 053
16600 90060	9 430 610 058
16600 95004	9 430 610 997
16600 95011	9 430 611 060
16600 95015	9 430 611 370
16600 96605	9 430 611 529
16600 97068	9 430 611 388
16600 97073	9 430 611 536
16610 L9200	9 430 615 046
16610 90016	9 430 615 048
16650 00Z11	0 414 701 033
16700 C9601	9 460 610 573
16700 DB000	0 445 010 094
16700 D2700	9 460 610 125
16700 D4600	9 460 610 380
16700 D9708	0 432 117 001
16700 G3610	9 460 610 707
16700 K6700	9 460 610 763
16700 K6701	9 460 610 764
16700 K6702	9 460 610 765
16700MA70B	0 445 010 136
16700MA70C	0 445 010 136
16700 R8313	9 460 610 135
16700 R8801	9 460 610 280
16700 T8212	9 460 610 048
16700 T8273	9 460 610 053
16700 VB300	9 460 611 586
16700 VH202	9 460 611 503
16700 VZ20A	0 445 010 194
16700 VZ20A	0 445 010 195
16700 V0762	9 460 610 177
16700 V2100	9 460 610 085
16700 W3410	9 460 611 181
16700 0F005	9 460 610 702
16700 0F200	9 460 612 075
16700 0W800	9 460 611 581
16700 00Q0K	0 445 010 099
16700 00Q0K	0 986 437 355
16700 00Q0L	0 445 010 170
16700 00Q1A	0 445 010 099
16700 00Q1A	0 986 437 355
16700 00Q1B	0 445 010 295
16700 00Q1D	0 445 010 170
16700 00Q1E	0 445 010 223
16700 00W01	9 460 610 051
16700 02N14	9 460 610 240
16700 02N70	9 460 610 416
16700 02N74	9 460 610 341
16700 05D10	9 460 611 660
16700 05D11	9 460 611 661

16700 05E20	9 460 610 567
16700 05E21	9 460 610 438
16700 09W05	9 460 610 251
16700 1C511	9 460 610 635
16700 1F200	9 460 610 791
16700 10H05	9 460 610 412
16700 10T10	9 460 610 732
16700 10T11	9 460 610 388
16700 13C00	9 460 610 260
16700 14CE1	9 460 610 426
16700 14C00	9 460 610 393
16700 16A01	9 460 610 483
16700 16A03	9 460 610 485
16700 16A63	9 460 610 066
16700 16A77	9 460 610 066
16700 2H213	9 460 611 021
16700 2J620	0 460 404 965
16700 2S614	9 460 611 356
16700 21T08	9 460 610 436
16700 22J02	9 460 610 572
16700 22J20	9 460 610 556
16700 23G02	9 460 610 220
16700 24N01	9 460 614 311
16700 30N12	9 460 610 588
16700 37G02	9 460 610 140
16700 43G13	9 460 610 325
16700 43G19	9 460 610 536
16700 43G20	9 460 610 538
16700 44G04	9 460 610 314
16700 47N00	9 460 610 734
16700 5M320	0 470 504 012
16700 5M320	0 986 444 013
16700 5M321	0 470 504 012
16700 5M321	0 986 444 013
16700 5M322	0 986 444 057
16700 5M384	0 986 444 057
16700 50L15	9 460 610 497
16700 51H12	9 460 612 000
16700 51N20	9 460 610 846
16700 54A00	9 460 610 437
16700 54A03	9 460 610 385
16700 54A11	9 460 610 437
16700 54W03	9 460 610 010
16700 56T02	9 460 611 937
16700 57J14	9 460 610 551
16700 57J17	9 460 610 552
16700 59Y01	9 460 610 701
16700 60J21	9 460 610 553
16700 69T60	0 986 444 056
16700 69T61	0 470 504 023
16700 69T61	0 986 444 056
16700 69T62	0 470 504 023
16700 69T62	0 986 444 056
16700 69T63	0 470 504 042
16700 69T63	0 986 444 058

16700 7F405	0 460 404 974
16700 7F405	0 986 440 508
16700 7F406	0 460 404 974
16700 7F406	0 986 440 508
16700 7F410	9 460 613 261
16700 75J00	9 460 610 703
16700 76R00	9 460 610 597
16700 76R20	9 460 610 597
16700 78750	0 460 404 965
16700 80G17	9 460 610 561
16700 9X700	0 470 504 022
16700 9X700	0 986 444 081
16700 9X701	0 470 504 022
16700 9X701	0 986 444 081
16700 9X702	0 470 504 022
16700 9X702	0 986 444 081
16700 9X800	0 470 506 025
16700 9X800	0 986 444 080
16700 9X801	0 470 506 025
16700 9X801	0 986 444 080
16700 9X802	0 470 506 025
16700 9X802	0 986 444 080
16700 90078	9 460 610 633
16700 90160	9 460 611 364
16700 95N20	9 460 610 956
16700 96550 1	0 986 444 057
16700 98702	0 470 506 025
16700 98702	0 986 444 080
16701 00Q0A	0 445 010 140
20417 00Z0D	0 444 010 016
21582907	0 444 022 037
89702 83300	9 460 610 453

**NISSAN MOTOR  
IBERICA**

167005M3207	0 986 444 013
-------------	---------------

**OPEL**

R1 590 056	0 470 504 218
R1 590 057	0 445 010 009
09109203	0 445 010 033
09117081	0 986 444 500
09118473	9 460 620 010
09118474	0 986 440 150
09118477	9 460 620 002
09118478	9 460 620 001
09118479	9 460 620 003
09118483	9 460 610 656
09118484	0 986 440 002
09118485	0 986 440 143
09118487	9 460 620 009

09118488	9 460 610 596
09118489	9 460 610 609
09118490	9 460 620 015
09118491	9 460 620 014
09118492	9 460 620 017
09118494	0 460 494 372
09118494	0 986 440 152
09119165	0 986 440 516
09119221	0 986 444 005
09129340	0 986 444 005
09158202	0 986 444 012
09158926	0 986 444 001
09192376	0 986 430 302
09192986	0 986 444 005
09192987	0 986 444 001
09192988	0 986 444 002
09192989	0 986 444 003
09192991	0 986 444 005
09192992	0 986 444 001
09192993	0 986 444 002
09192994	0 986 444 003
09193454	0 986 444 012
09196713	0 986 444 014
09196993	0 986 444 012
09196994	0 986 444 500
09196995	0 986 444 012
09196996	0 986 444 500
09199204	0 986 444 021
09199205	0 986 444 021
09201510	0 986 444 014
09202063	0 470 504 218
09202063	0 986 444 036
09704361	9 430 610 129
12620534	0 445 117 010
1590043	0 470 504 015
1590050	0 470 504 016
1590055	0 470 504 219
1590056	0 470 504 218
1590056	0 986 444 036
24413103	0 470 504 015
24413103	0 986 444 014
24413104	0 470 504 016
24413104	0 986 444 021
24443598	0 432 193 634
24451341	0 470 504 206
24451343	0 986 444 028
24451344	0 986 444 028
24451346	0 986 444 029
24451347	0 470 504 206
24451347	0 986 444 030
55192739	0 445 110 159
55192739	0 986 435 088
55192741	0 445 110 165
55193731	0 445 010 097
55193731	0 986 437 025



## ◀ OPEL

55198218	<b>0 445 110 243</b>	8 19 039	<b>9 460 620 002</b>	90543882	<b>0 986 444 003</b>	93169127	<b>0 986 435 089</b>
55198218	<b>0 986 435 104</b>	8 19 044	<b>9 460 620 001</b>	90571722	<b>0 986 444 002</b>	93169129	<b>0 986 435 079</b>
55200259	<b>0 445 110 276</b>	8 19 045	<b>9 460 620 003</b>	90571813	<b>0 432 217 299</b>	93169133	<b>0 986 435 075</b>
55200259	<b>0 986 435 148</b>	8 19 059	<b>9 460 620 007</b>	90571813	<b>0 986 430 449</b>	93169135	<b>0 986 435 106</b>
55204599	<b>0 445 010 097</b>	8 19 093	<b>0 460 404 991</b>	90572504	<b>0 986 444 500</b>	93169137	<b>0 986 435 086</b>
55204599	<b>0 986 437 025</b>	8 19 094	<b>9 460 620 020</b>	90573867	<b>0 432 193 686</b>	93169139	<b>0 986 435 007</b>
55206489	<b>0 445 010 293</b>	8 21 165	<b>0 432 217 196</b>	9109268	<b>0 445 010 075</b>	93169141	<b>0 986 435 095</b>
55206489	<b>0 986 437 086</b>	8 21 165	<b>0 986 430 448</b>	9109795	<b>0 445 110 141</b>	93171107	<b>0 445 110 049</b>
55206679	<b>0 445 010 288</b>	8 21 170	<b>0 986 430 243</b>	9109795	<b>0 986 435 086</b>	93171119	<b>0 470 504 206</b>
55206680	<b>0 445 010 287</b>	8 21 171	<b>0 986 433 000</b>	9110535	<b>0 445 110 063</b>	93171707	<b>0 986 435 095</b>
55209063	<b>0 445 010 365</b>	87803276	<b>0 432 191 351</b>	9110535	<b>0 986 435 075</b>	93171940	<b>0 432 193 525</b>
55209064	<b>0 445 010 378</b>	90349026	<b>0 432 217 196</b>	91117808	<b>0 432 193 688</b>	93172230	<b>0 470 504 209</b>
55221017	<b>0 445 110 276</b>	90349026	<b>0 986 430 448</b>	9112247	<b>0 445 110 087</b>	93172230	<b>0 986 444 028</b>
55350002	<b>0 986 444 030</b>	90369648	<b>0 460 406 994</b>	9112247	<b>0 986 435 079</b>	93172231	<b>0 470 504 210</b>
55351299	<b>0 432 193 512</b>	90412095	<b>0 986 430 243</b>	91153667	<b>0 460 404 991</b>	93172231	<b>0 986 444 029</b>
55351512	<b>0 432 193 512</b>	90442374	<b>0 986 430 243</b>	9117868	<b>0 432 193 687</b>	93172233	<b>0 986 444 028</b>
55351527	<b>0 986 444 037</b>	90444313	<b>0 460 404 074</b>	9118472	<b>9 460 620 011</b>	93172234	<b>0 986 444 029</b>
55351528	<b>0 986 444 030</b>	90444313	<b>0 986 440 002</b>	9118474	<b>0 460 494 353</b>	93173725	<b>0 470 504 208</b>
55351757	<b>0 986 444 028</b>	90444993	<b>0 986 440 143</b>	9118482	<b>9 460 620 007</b>	93174504	<b>0 470 504 217</b>
55352155	<b>0 986 444 028</b>	90448920	<b>0 986 440 143</b>	9118484	<b>0 460 404 074</b>	93174504	<b>0 986 444 030</b>
55352156	<b>0 986 444 030</b>	90466438	<b>0 460 404 074</b>	9118486	<b>9 460 620 008</b>	93175025	<b>0 470 504 217</b>
55352157	<b>0 986 444 029</b>	90466438	<b>0 986 440 002</b>	9118493	<b>9 460 620 016</b>	93175025	<b>0 986 444 030</b>
55352860	<b>0 986 444 037</b>	90467741	<b>0 460 494 353</b>	9118494	<b>0 460 494 372</b>	93175730	<b>0 470 504 219</b>
55352861	<b>0 986 444 030</b>	90467741	<b>0 986 440 150</b>	9119165	<b>0 460 406 994</b>	93175730	<b>0 986 444 037</b>
55352862	<b>0 986 444 037</b>	90501098	<b>0 986 444 001</b>	9119514	<b>0 432 193 650</b>	93175731	<b>0 470 504 218</b>
55352863	<b>0 986 444 037</b>	90501099	<b>0 986 444 002</b>	9129719	<b>0 432 193 650</b>	93175731	<b>0 986 444 036</b>
55352864	<b>0 470 504 218</b>	90501100	<b>0 470 504 004</b>	9158202	<b>0 470 504 011</b>	93175914	<b>0 432 193 512</b>
55352864	<b>0 986 444 036</b>	90501100	<b>0 986 444 003</b>	9158400	<b>0 432 193 634</b>	93177319	<b>0 445 010 277</b>
55352865	<b>0 470 504 218</b>	90501468	<b>0 432 193 688</b>	9158401	<b>0 432 193 633</b>	93177319	<b>0 986 437 024</b>
55352865	<b>0 986 444 036</b>	90501560	<b>0 432 193 687</b>	9192374	<b>0 432 217 236</b>	93177373	<b>0 445 110 083</b>
55352883	<b>0 470 504 219</b>	90509260	<b>0 986 430 241</b>	9192377	<b>0 432 217 279</b>	93177373	<b>0 986 435 078</b>
55352883	<b>0 986 444 037</b>	90510940	<b>0 460 494 353</b>	9192712	<b>0 432 193 633</b>	93178684	<b>0 445 110 165</b>
55352884	<b>0 470 504 218</b>	90510940	<b>0 986 440 150</b>	9192713	<b>0 432 193 634</b>	93179047	<b>0 445 110 159</b>
55352884	<b>0 986 444 036</b>	90512990	<b>0 460 494 372</b>	9192988	<b>0 470 504 003</b>	93179047	<b>0 986 435 088</b>
55556383	<b>0 470 504 218</b>	90512990	<b>0 986 440 152</b>	9192989	<b>0 470 504 004</b>	93182410	<b>0 445 010 097</b>
55556383	<b>0 986 444 036</b>	90529084	<b>0 460 494 372</b>	9193454	<b>0 470 504 011</b>	93182410	<b>0 986 437 025</b>
55564218	<b>0 445 110 326</b>	90529084	<b>0 986 440 152</b>	9196701	<b>0 432 193 569</b>	93183595	<b>0 445 110 021</b>
55564969	<b>0 445 110 393</b>	90529844	<b>0 460 494 372</b>	9196933	<b>0 470 504 011</b>	93183910	<b>0 445 110 083</b>
55565210	<b>0 445 010 550</b>	90529844	<b>0 986 440 152</b>	9198651	<b>0 432 193 634</b>	93183910	<b>0 986 435 078</b>
55565345	<b>0 445 010 371</b>	90530752	<b>0 470 504 004</b>	9199204	<b>0 470 504 016</b>	93184174	<b>0 986 437 086</b>
55566050	<b>0 445 110 327</b>	90530752	<b>0 986 444 003</b>	9200844	<b>0 432 193 570</b>	93184178	<b>0 986 435 102</b>
55567369	<b>0 445 010 293</b>	90531841	<b>0 460 494 372</b>	9201510	<b>0 470 504 015</b>	93184794	<b>0 445 110 159</b>
55567370	<b>0 445 010 278</b>	90531841	<b>0 986 440 152</b>	9202065	<b>0 470 504 208</b>	93184794	<b>0 986 435 088</b>
55571005	<b>0 445 010 371</b>	90531842	<b>0 460 494 353</b>	9202472	<b>0 432 193 525</b>	93185536	<b>0 445 010 009</b>
55572537	<b>0 445 010 293</b>	90531842	<b>0 986 440 150</b>	9202473	<b>0 432 193 570</b>	93186428	<b>0 445 110 165</b>
55574632	<b>0 445 010 382</b>	90541239	<b>0 460 494 353</b>	9202474	<b>0 432 193 569</b>	93186428	<b>0 986 435 103</b>
55575968	<b>0 445 010 387</b>	90541239	<b>0 986 440 150</b>	93161695	<b>0 445 115 007</b>	93186431	<b>0 986 437 086</b>
55577044	<b>0 445 110 425</b>	90541240	<b>0 460 494 372</b>	93161695	<b>0 986 435 350</b>	93187882	<b>0 445 010 278</b>
55577668	<b>0 445 110 423</b>	90541240	<b>0 986 440 152</b>	93169113	<b>0 986 435 078</b>	93188709	<b>0 445 010 097</b>
5819035	<b>0 986 444 012</b>	90541723	<b>0 986 430 302</b>	93169115	<b>0 986 435 102</b>	93188709	<b>0 986 437 025</b>
5819073	<b>0 986 437 086</b>	90541915	<b>0 432 217 299</b>	93169117	<b>0 986 435 082</b>	93189905	<b>0 986 437 317</b>
5821100	<b>0 445 110 159</b>	90541915	<b>0 986 430 449</b>	93169119	<b>0 986 435 103</b>	93189952	<b>0 445 110 265</b>
5821100	<b>0 986 435 088</b>	90542288	<b>0 986 444 002</b>	93169121	<b>0 986 435 088</b>	93190244	<b>0 445 010 288</b>
5821110	<b>0 445 110 165</b>	90543761	<b>0 432 193 686</b>	93169123	<b>0 986 435 104</b>	93190245	<b>0 445 010 287</b>
8 19 001	<b>9 460 620 011</b>	90543882	<b>0 470 504 004</b>	93169125	<b>0 986 435 105</b>	93190330	<b>0 445 110 102</b>



93190330	<b>0 986 435 106</b>
93190336	<b>0 445 110 087</b>
93190346	<b>0 445 110 141</b>
93190429	<b>0 445 110 276</b>
93190429	<b>0 986 435 148</b>

93190435	<b>0 445 110 183</b>
93190497	<b>0 986 437 026</b>
93190668	<b>0 445 010 293</b>
93190668	<b>0 986 437 086</b>
93191383	<b>0 445 010 173</b>

93191709	<b>0 445 010 365</b>
93191710	<b>0 445 010 378</b>
94459142	<b>0 986 433 004</b>
94459142	<b>9 430 610 136</b>
94460004	<b>0 986 433 005</b>

94460004	<b>9 430 610 137</b>
96440341	<b>0 445 010 142</b>
96440397	<b>0 445 110 269</b>
97040843	<b>9 460 620 007</b>
9704360	<b>9 430 610 128</b>

97043760	<b>0 986 433 002</b>
97043760	<b>9 430 610 128</b>
97043761	<b>9 430 610 129</b>
97078638	<b>9 460 620 008</b>
97078639	<b>9 460 620 009</b>

97085182	<b>9 460 620 010</b>
97088673	<b>0 986 433 001</b>
97088673	<b>9 430 610 140</b>
97092955	<b>9 460 620 011</b>
97103271	<b>9 460 610 708</b>

97121228	<b>9 460 620 011</b>
97121228	<b>9 460 620 017</b>
97122823	<b>9 460 620 013</b>
97134840	<b>9 460 610 952</b>
97139269	<b>9 460 620 020</b>

97143328	<b>9 460 620 019</b>
97143328	<b>9 460 620 023</b>
97161455	<b>9 430 610 163</b>
97174103	<b>9 460 611 452</b>
97300091	<b>0 445 110 118</b>

97300091	<b>0 986 435 082</b>
97327924	<b>0 445 010 086</b>
98433633	<b>0 986 435 082</b>
98433635	<b>0 445 110 174</b>
98433635	<b>0 986 435 105</b>

98433636	<b>0 445 110 175</b>
98433636	<b>0 986 435 089</b>

## OTOSAN

6C465H297BD	<b>0 444 022 027</b>
-------------	----------------------

## PERKINS

CV 17009	<b>0 432 291 044</b>
CV 68655	<b>0 432 191 458</b>
OD 20361	<b>0 432 191 790</b>

OD 20362	<b>0 432 191 789</b>
OD 20743	<b>0 432 191 764</b>
OD 21868	<b>0 432 191 691</b>
1398 0241	<b>0 460 414 053</b>
2463 J 627	<b>0 460 426 247</b>

2643 F 001	<b>0 460 423 001</b>
2643 F 024	<b>0 432 133 829</b>
2643 H 051	<b>0 460 414 041</b>
2643 H 052	<b>0 460 414 042</b>
2643 H 053	<b>0 460 424 036</b>

2643 H 054	<b>0 460 424 037</b>
2643 H 057	<b>0 460 414 046</b>
2643 H 060	<b>0 460 414 053</b>
2643 H 065	<b>0 460 424 052</b>
2643 H 070	<b>0 460 414 090</b>

2643 H 075	<b>0 460 424 097</b>
2643 H 076	<b>0 460 424 100</b>
2643 H 076	<b>0 460 426 228</b>
2643 H 077	<b>0 460 424 097</b>
2643 H 077	<b>0 460 424 100</b>

2643 H 080	<b>0 460 414 124</b>
2643 H 081	<b>0 460 414 135</b>
2643 H 082	<b>0 460 424 052</b>
2643 H 083	<b>0 460 424 140</b>
2643 H 084	<b>0 460 424 140</b>

2643 H 085	<b>0 460 414 165</b>
2643 J 601	<b>0 460 426 085</b>
2643 J 603	<b>0 460 426 239</b>
2643 J 610	<b>0 460 426 162</b>
2643 J 611	<b>0 460 426 085</b>

2643 J 612	<b>0 460 426 179</b>
2643 J 620	<b>0 460 426 179</b>
2643 J 623	<b>0 460 426 228</b>
2643 J 625	<b>0 460 426 228</b>
2643 J 627	<b>0 460 426 247</b>

2643 J 630	<b>0 460 426 267</b>
2643 J 631	<b>0 460 426 268</b>
2643 J 632	<b>0 460 426 162</b>
2643 J 633	<b>0 460 426 268</b>
2643 J 633	<b>0 460 426 275</b>

2643 J 635	<b>0 460 426 276</b>
2643 J 639	<b>0 460 426 286</b>
2643 J 640	<b>0 460 426 349</b>
2643 J 641	<b>0 460 426 349</b>
2644 N 002	<b>0 460 424 140</b>

2644 N 202	<b>0 460 424 303</b>
2644 N 203	<b>0 460 424 255</b>
2644 N 204	<b>0 986 444 516</b>
2644 N 208	<b>0 460 424 303</b>
2644 N 209	<b>0 460 424 255</b>

2644 N 405	<b>0 460 424 323</b>
2644 N 408	<b>0 460 424 323</b>
2644 P 101	<b>0 460 426 268</b>
2644 P 205	<b>0 460 426 275</b>
2644 P 208	<b>0 460 426 275</b>

2644 P 301	<b>0 460 426 288</b>
2644 P 309	<b>0 460 426 288</b>
2644 P 401	<b>0 460 426 287</b>
2644 P 501	<b>0 986 444 518</b>
2644 P 502	<b>0 986 444 517</b>

2645 F 005	<b>0 432 291 638</b>
2645 F 006	<b>0 432 291 634</b>
2645 F 008	<b>0 432 191 779</b>
2645 F 011	<b>0 432 291 577</b>
2645 F 013	<b>0 432 193 828</b>

2645 F 014	<b>0 432 193 826</b>
2645 F 015	<b>0 432 193 826</b>
2645 F 016	<b>0 432 193 816</b>
2645 F 019	<b>0 432 291 518</b>
2645 F 022	<b>0 432 193 755</b>

2645 F 023	<b>0 432 133 830</b>
2645 F 024	<b>0 432 133 829</b>
2645 F 025	<b>0 432 133 821</b>
2645 F 026	<b>0 432 133 820</b>
2645 F 027	<b>0 432 133 788</b>

2645 M 001	<b>9 430 610 167</b>
2645 M 002	<b>9 430 610 442</b>
2645 M 004	<b>9 430 613 108</b>

## PEUGEOT

1920 AL	<b>0 445 010 021</b>
1920 AL	<b>0 986 437 012</b>
1920 AZ	<b>0 445 020 002</b>

1920 AZ	<b>0 986 437 501</b>
1920 CS	<b>0 460 484 148</b>
1920 CY	<b>0 445 010 010</b>
1920 EA	<b>0 445 010 046</b>
1920 EC	<b>0 445 010 042</b>

1920 EC	<b>0 986 437 309</b>
1920 FZ	<b>0 445 010 089</b>
1920 FZ	<b>0 986 437 322</b>
1920 HT	<b>0 445 010 296</b>
1920 HT	<b>0 986 437 028</b>

1920 JE	<b>0 445 010 132</b>
1920 JE	<b>0 445 010 284</b>
1920 KY	<b>0 445 010 367</b>
1920 NC	<b>0 445 010 282</b>
1920 NE	<b>0 445 010 283</b>

1920 NF	<b>0 445 010 284</b>
1920 N2	<b>0 460 494 310</b>
1920 N3	<b>0 460 494 313</b>
1920 N6	<b>0 460 494 278</b>
1920 PH	<b>0 445 010 367</b>

1920 QO	<b>0 460 494 278</b>
1920 RF	<b>0 445 010 552</b>
1920 RG	<b>0 445 010 614</b>
1920 R8	<b>0 460 484 064</b>
1920 R8	<b>0 986 440 094</b>

1920 S4	<b>0 986 440 146</b>
1920 S9	<b>0 460 494 344</b>
1920 V5	<b>0 460 404 993</b>
1920 V5	<b>0 986 440 512</b>
1920 W0	<b>0 460 494 278</b>

1920 W2	<b>0 460 494 344</b>
1920 X3	<b>0 460 484 070</b>
1920 OC	<b>0 460 484 078</b>
1920 OH	<b>0 460 484 070</b>
1920 OK	<b>0 460 494 367</b>

1920 OM	<b>0 460 494 382</b>
1920 1T	<b>0 460 494 384</b>
1920 1W	<b>0 460 494 430</b>
1920 1X	<b>0 460 484 111</b>
1920 2N	<b>0 460 494 423</b>

1920 2N	<b>0 986 440 156</b>
1920 2P	<b>0 460 494 384</b>
1920 2T	<b>0 460 494 411</b>
1920 21	<b>0 460 494 079</b>
1920 3T	<b>0 986 440 051</b>

1920 33	<b>0 460 494 121</b>
1920 4E	<b>0 460 484 109</b>
1920 4Z	<b>0 460 484 138</b>
1920 5R	<b>0 460 494 446</b>
1920 6F	<b>0 460 494 459</b>

1920 6X	<b>0 445 010 010</b>
1920 6X	<b>0 986 437 005</b>
1920 7G	<b>0 460 484 137</b>
1920 7H	<b>0 986 440 161</b>
1920 8A	<b>0 460 484 131</b>

1920 8C	<b>0 460 484 146</b>
1920 8K	<b>0 460 494 467</b>
1920 8P	<b>0 460 494 483</b>
1920 87	<b>0 460 494 223</b>
1979 45	<b>0 986 430 010</b>

1979 46	<b>0 986 430 015</b>
1979 46	<b>0 986 430 028</b>
1979 47	<b>0 986 430 015</b>
1979 47	<b>0 986 430 028</b>
1980 AN	<b>0 986 435 014</b>

1980 A9	<b>0 445 110 135</b>
1980 A9	<b>0 986 435 085</b>
1980 EJ	<b>0 445 110 339</b>
1980 E5	<b>0 445 110 136</b>
1980 E5	<b>0 445 110 188</b>

1980 E5	<b>0 986 435 090</b>
1980 H2	<b>0 445 110 239</b>
1980 H2	<b>0 986 435 122</b>
1980 H3	<b>0 445 110 188</b>
1980 H3	<b>0 986 435 090</b>



## ◀ PEUGEOT

1980 H4	<b>0 445 110 036</b>	1980 83	<b>0 986 435 501</b>	96 227 365	<b>0 986 430 375</b>	96 384 889	<b>0 445 110 057</b>
1980 H4	<b>0 986 435 014</b>	1980 84	<b>0 445 110 076</b>	96 227 367	<b>0 986 430 375</b>	96 384 889	<b>0 986 435 093</b>
1980 H5	<b>0 445 110 036</b>	1980 84	<b>0 986 435 077</b>	96 227 398	<b>0 432 217 286</b>	96 386 523	<b>0 445 110 075</b>
1980 H5	<b>0 986 435 014</b>	1980 85	<b>0 445 110 076</b>	96 238 110	<b>0 460 494 384</b>	96 386 523	<b>0 986 435 076</b>
1980 H6	<b>0 445 110 036</b>	1980 85	<b>0 986 435 077</b>	96 240 260	<b>0 460 484 070</b>	96 400 887	<b>0 445 110 062</b>
1980 H6	<b>0 986 435 014</b>	1980 86	<b>0 445 110 076</b>	96 246 852	<b>0 986 440 051</b>	96 400 887	<b>0 986 435 077</b>
1980 H7	<b>0 445 110 076</b>	1980 86	<b>0 986 435 077</b>	96 254 185	<b>0 460 494 411</b>	96 408 953	<b>0 445 110 044</b>
1980 H7	<b>0 986 435 077</b>	1980 89	<b>0 445 110 075</b>	96 254 186	<b>0 460 494 412</b>	96 408 953	<b>0 986 435 003</b>
1980 H8	<b>0 445 110 076</b>	1980 89	<b>0 986 435 076</b>	96 254 187	<b>0 460 494 423</b>	96 414 961	<b>0 445 110 075</b>
1980 H8	<b>0 986 435 077</b>	1980 93	<b>0 445 110 044</b>	96 254 187	<b>0 986 440 156</b>	96 414 961	<b>0 986 435 076</b>
1980 H9	<b>0 445 110 076</b>	1980 93	<b>0 986 435 003</b>	96 254 193	<b>0 460 494 384</b>	96 416 540	<b>0 445 110 057</b>
1980 H9	<b>0 986 435 077</b>	1984 40	<b>0 986 430 028</b>	96 255 425	<b>0 986 435 003</b>	96 416 540	<b>0 986 435 093</b>
1980 J3	<b>0 445 110 259</b>	93 501 009	<b>0 460 494 079</b>	96 256 277	<b>0 460 484 131</b>	96 416 541	<b>0 445 110 057</b>
1980 J3	<b>0 986 435 126</b>	93 501 010	<b>0 460 494 121</b>	96 259 523	<b>0 460 484 111</b>	96 416 541	<b>0 986 435 093</b>
1980 J8	<b>0 445 115 025</b>	9350 101 080	<b>0 460 494 121</b>	96 259 538	<b>0 460 494 430</b>	96 416 542	<b>0 445 110 057</b>
1980 J8	<b>0 986 435 351</b>	9350 109 180	<b>0 986 430 015</b>	96 264 661	<b>0 432 217 301</b>	96 416 542	<b>0 986 435 093</b>
1980 K2	<b>0 445 110 252</b>	9350 109 180	<b>0 986 430 028</b>	96 272 026	<b>0 460 484 109</b>	96 419 449	<b>0 445 110 076</b>
1980 K2	<b>0 986 435 143</b>	9350 138 080	<b>0 986 430 010</b>	96 276 639	<b>0 445 010 021</b>	96 419 449	<b>0 986 435 077</b>
1980 K7	<b>0 445 110 281</b>	9351 045 480	<b>0 986 430 028</b>	96 276 639	<b>0 986 437 012</b>	96 419 450	<b>0 445 110 076</b>
1980 K7	<b>0 986 435 150</b>	96 004 017	<b>0 986 430 028</b>	96 282 404	<b>0 445 110 036</b>	96 419 450	<b>0 986 435 077</b>
1980 K9	<b>0 445 110 297</b>	96 011 913	<b>0 986 430 028</b>	96 282 404	<b>0 986 435 014</b>	96 419 451	<b>0 445 110 076</b>
1980 K9	<b>0 986 435 150</b>	96 014 904	<b>0 460 494 223</b>	96 288 220	<b>0 432 217 310</b>	96 419 451	<b>0 986 435 077</b>
1980 L1	<b>0 445 110 311</b>	96 036 729	<b>0 432 217 152</b>	96 298 937	<b>0 460 484 148</b>	96 421 669	<b>0 445 010 046</b>
1980 L1	<b>0 986 435 146</b>	96 036 735	<b>0 432 217 193</b>	96 313 069	<b>0 460 484 138</b>	96 421 669	<b>0 986 437 017</b>
1980 S5	<b>0 445 110 340</b>	96 069 910	<b>0 432 217 218</b>	96 318 692	<b>0 460 484 146</b>	96 421 669	<b>0 445 110 136</b>
1980 18	<b>0 432 217 270</b>	96 069 910	<b>0 432 217 248</b>	96 320 137	<b>0 445 010 010</b>	96 466 862	<b>0 986 435 090</b>
1980 23	<b>0 432 217 286</b>	96 069 910	<b>0 986 430 240</b>	96 320 137	<b>0 986 437 005</b>	96 481 471	<b>0 445 010 089</b>
1980 27	<b>0 432 193 728</b>	96 069 910	<b>0 986 430 244</b>	96 321 644	<b>0 460 494 459</b>	96 481 471	<b>0 986 437 322</b>
1980 58	<b>0 986 435 003</b>	96 076 130	<b>0 460 494 278</b>	96 328 436	<b>0 432 217 310</b>	96 485 754	<b>0 445 110 136</b>
1980 60	<b>0 432 217 301</b>	96 115 902	<b>0 460 494 313</b>	96 328 878	<b>0 460 484 137</b>	96 485 754	<b>0 986 435 090</b>
1980 68	<b>0 432 117 002</b>	96 122 780	<b>0 432 217 248</b>	96 328 879	<b>0 460 494 455</b>	96 487 862	<b>0 445 110 135</b>
1980 71	<b>0 445 110 008</b>	96 122 780	<b>0 986 430 244</b>	96 328 879	<b>0 986 440 161</b>	96 487 862	<b>0 986 435 085</b>
1980 71	<b>0 445 110 044</b>	96 129 622	<b>0 460 494 310</b>	96 331 365	<b>0 460 494 459</b>	96 492 841	<b>0 445 010 089</b>
1980 71	<b>0 986 435 003</b>	96 139 285	<b>0 460 484 078</b>	96 331 694	<b>0 460 494 467</b>	96 492 841	<b>0 986 437 322</b>
1980 72	<b>0 445 110 044</b>	96 151 697	<b>0 432 217 268</b>	96 352 463	<b>0 445 110 057</b>	96 507 606	<b>0 445 110 136</b>
1980 72	<b>0 986 435 003</b>	96 151 697	<b>0 986 430 381</b>	96 352 463	<b>0 986 435 093</b>	96 507 606	<b>0 986 435 090</b>
1980 73	<b>0 445 110 036</b>	96 154 507	<b>0 460 404 993</b>	96 364 040	<b>0 445 110 036</b>	96 518 443	<b>0 445 010 089</b>
1980 73	<b>0 986 435 014</b>	96 154 507	<b>0 986 440 512</b>	96 364 040	<b>0 986 435 014</b>	96 518 443	<b>0 986 437 322</b>
1980 74	<b>0 445 110 036</b>	96 154 509	<b>0 986 440 146</b>	96 372 779	<b>0 445 110 036</b>	96 528 920	<b>0 445 110 188</b>
1980 74	<b>0 986 435 014</b>	96 154 523	<b>0 986 430 371</b>	96 372 779	<b>0 986 435 014</b>	96 528 920	<b>0 986 435 090</b>
1980 75	<b>0 445 110 036</b>	96 154 524	<b>0 432 217 270</b>	96 373 173	<b>0 445 010 042</b>	96 533 448	<b>0 445 110 036</b>
1980 75	<b>0 986 435 014</b>	96 154 526	<b>0 432 217 268</b>	96 373 173	<b>0 986 437 309</b>	96 533 448	<b>0 986 435 014</b>
1980 77	<b>0 445 110 062</b>	96 154 526	<b>0 986 430 381</b>	96 375 360	<b>0 445 110 044</b>	96 533 457	<b>0 445 110 036</b>
1980 77	<b>0 986 435 077</b>	96 155 902	<b>0 460 494 313</b>	96 375 360	<b>0 986 435 003</b>	96 533 457	<b>0 986 435 014</b>
1980 78	<b>0 445 110 057</b>	96 173 516	<b>0 460 494 278</b>	96 376 359	<b>0 445 010 042</b>	96 533 458	<b>0 445 110 036</b>
1980 78	<b>0 986 435 093</b>	96 180 183	<b>0 460 484 064</b>	96 376 359	<b>0 986 437 309</b>	96 533 458	<b>0 986 435 014</b>
1980 79	<b>0 445 110 057</b>	96 183 769	<b>0 432 193 728</b>	96 384 447	<b>0 445 110 036</b>	96 533 459	<b>0 445 110 036</b>
1980 79	<b>0 986 435 093</b>	96 189 578	<b>0 460 484 070</b>	96 384 447	<b>0 986 435 014</b>	96 533 459	<b>0 986 435 014</b>
1980 80	<b>0 445 110 057</b>	96 190 451	<b>0 460 494 367</b>	96 384 447	<b>0 986 435 014</b>	96 535 942	<b>0 445 110 076</b>
1980 80	<b>0 986 435 093</b>	96 219 885	<b>0 460 484 091</b>	96 384 448	<b>0 445 110 036</b>	96 535 942	<b>0 986 435 077</b>
1980 81	<b>0 445 120 002</b>	96 219 895	<b>0 460 494 382</b>	96 384 448	<b>0 986 435 014</b>	96 550 450	<b>0 445 110 188</b>
1980 81	<b>0 986 435 501</b>	96 222 802	<b>0 460 494 278</b>	96 384 448	<b>0 986 435 014</b>	96 550 450	<b>0 986 435 090</b>
1980 82	<b>0 445 110 062</b>	96 222 804	<b>0 460 494 344</b>	96 384 449	<b>0 445 110 036</b>	96 561 543	<b>0 445 010 132</b>
1980 82	<b>0 986 435 077</b>	96 227 102	<b>0 460 494 446</b>	96 384 449	<b>0 986 435 014</b>	96 561 543	<b>0 986 437 018</b>
1980 83	<b>0 445 120 002</b>	96 227 298	<b>0 432 217 286</b>	96 384 449	<b>0 986 435 014</b>	96 565 889	<b>0 445 110 252</b>
96 384 448	<b>0 986 435 014</b>			96 384 448	<b>0 986 435 015</b>		
96 384 448	<b>0 986 435 014</b>			96 384 448	<b>0 986 435 015</b>		

96 565 889	<b>0 986 435 143</b>
96 589 498	<b>0 445 110 285</b>
96 592 288	<b>0 445 115 025</b>
96 592 288	<b>0 986 435 351</b>
96 592 291	<b>0 445 115 042</b>

96 592 291	<b>0 986 435 362</b>
96 592 405	<b>0 445 110 281</b>
96 592 405	<b>0 986 435 150</b>
96 596 666	<b>0 445 110 239</b>
96 596 666	<b>0 986 435 122</b>

96 640 424	<b>0 445 110 062</b>
96 640 424	<b>0 986 435 077</b>
96 884 996 80	<b>0 445 010 552</b>

POCLAIN	
F 1243293	<b>0 432 291 753</b>
F 1243293	<b>0 986 430 067</b>
F 1843271	<b>0 432 291 782</b>
V 1343265	<b>0 432 291 752</b>

POWERTRAIN	
55214159	<b>0 445 110 326</b>
55216287	<b>0 445 010 293</b>
55227408	<b>0 445 010 293</b>
552315720	<b>0 445 010 381</b>

PSA (PEUGEOT S.A.)	
1980AE	<b>0 986 435 014</b>
1980AG	<b>0 986 435 014</b>
1980AJ	<b>0 986 435 014</b>
1980AL	<b>0 986 435 014</b>
1980AP	<b>0 986 435 014</b>
1980AV	<b>0 986 435 077</b>
1980AW	<b>0 986 435 077</b>
1980AX	<b>0 986 435 077</b>
1980CC	<b>0 986 435 077</b>
1980CE	<b>0 986 435 077</b>
1980CF	<b>0 986 435 077</b>
1980CK	<b>0 986 435 003</b>
1980CL	<b>0 986 435 093</b>
1980CN	<b>0 986 435 093</b>
1980CP	<b>0 986 435 093</b>
1980CS	<b>0 986 435 090</b>
1980CT	<b>0 986 435 126</b>
1980CV	<b>0 986 435 150</b>

1980CY	<b>0 986 435 085</b>
1980CZ	<b>0 986 435 076</b>
1980EA	<b>0 986 435 143</b>
1980EC	<b>0 986 435 501</b>
1980EE	<b>0 986 435 501</b>

1980EF	<b>0 986 435 020</b>
96 373 17380	<b>0 445 010 042</b>
96 373 17380	<b>0 986 437 309</b>
96 384 88980	<b>0 445 110 057</b>
96 384 88980	<b>0 986 435 093</b>
96 417 42880	<b>0 445 110 076</b>
96 417 42880	<b>0 986 435 077</b>
96 487 86280	<b>0 445 110 135</b>
96 487 86280	<b>0 986 435 085</b>
96.528920.80A	<b>0 445 110 188</b>

96.528920.80A	<b>0 986 435 090</b>
96 533 44880	<b>0 445 110 036</b>
96 533 44880	<b>0 986 435 014</b>
96 535 94280	<b>0 445 110 076</b>
96 535 94280	<b>0 986 435 077</b>
96 547 94380	<b>0 445 010 296</b>
96 547 94380	<b>0 986 437 028</b>
96 550 45080	<b>0 445 110 188</b>
96 550 45080	<b>0 986 435 090</b>
96 553 28480	<b>0 445 110 259</b>

96 553 28480	<b>0 986 435 126</b>
96 556 06680	<b>0 445 110 239</b>
96 556 06680	<b>0 986 435 122</b>
96 561 54380	<b>0 445 010 132</b>
96 563 00380	<b>0 445 010 296</b>
96 565 88980	<b>0 445 110 252</b>
96 565 88980	<b>0 986 435 143</b>
96 569 18380	<b>0 445 010 367</b>
96 589 49880	<b>0 445 110 285</b>
96 592 28880	<b>0 445 115 025</b>

96 592 28880	<b>0 986 435 351</b>
96 592 29180	<b>0 445 115 042</b>
96 592 29180	<b>0 986 435 362</b>
96 592 40580	<b>0 445 110 281</b>
96 592 40580	<b>0 986 435 150</b>
96 603 52980	<b>0 445 010 367</b>
96 620 02680	<b>0 445 110 297</b>
96 620 02680	<b>0 986 435 150</b>
96 620 03380	<b>0 986 435 146</b>
96 783 93480	<b>0 445 010 662</b>

96 832 68980	<b>0 445 010 367</b>
96 837 03780	<b>0 445 010 296</b>
96 837 03780	<b>0 986 437 028</b>
96 870 68980	<b>0 445 110 339</b>
96 870 69280	<b>0 445 110 340</b>

96 874 54480	<b>0 445 116 043</b>
--------------	----------------------

QUANCHAI (ANHUI QUANCH. POWER)	
4D22E41000	<b>0 445 110 346</b>

RENAULT	
00 00 554 0	<b>0 445 010 295</b>
00 25 851 058	<b>0 432 291 819</b>
00 48 100 065	<b>0 432 297 034</b>
09 08 200 079	<b>0 432 297 024</b>
16 60 013 87R	<b>0 986 435 086</b>
16610 5302R	<b>0 445 110 414</b>
21200985	<b>0 444 022 016</b>
21 35 067 2	<b>0 444 022 024</b>
21 35 067 3	<b>0 444 022 024</b>
50 00 134 786	<b>0 460 424 005</b>
50 00 136 981	<b>0 460 424 005</b>
50 00 289 356	<b>0 460 414 054</b>
50 00 289 356	<b>0 986 440 027</b>
50 00 289 516	<b>0 460 414 067</b>
50 00 289 516	<b>0 986 440 028</b>
50 00 289 860	<b>0 460 424 052</b>
50 00 395 022	<b>0 460 494 109</b>
50 00 592 825	<b>0 432 281 695</b>
50 00 592 825	<b>0 986 430 342</b>
50 00 659 162	<b>0 432 281 708</b>
50 00 667 707	<b>0 986 430 334</b>
50 00 670 712	<b>0 432 291 621</b>
50 00 670 712	<b>0 986 430 338</b>
50 00 676 305	<b>0 432 231 741</b>
50 00 676 305	<b>0 986 430 344</b>
50 00 678 956	<b>0 432 231 702</b>
50 00 678 956	<b>0 986 430 341</b>
50 00 684 556	<b>0 432 133 881</b>
50 00 684 559	<b>0 432 133 880</b>
50 00 686 053	<b>0 432 291 558</b>
50 00 686 053	<b>0 986 430 337</b>
50 00 691 225	<b>0 432 131 823</b>
50 00 691 255	<b>0 986 430 450</b>
50 00 691 343	<b>0 432 231 699</b>
50 00 691 343	<b>0 986 430 445</b>
50 00 691 451	<b>0 432 231 700</b>
50 00 691 504	<b>0 432 133 870</b>
50 00 691 834	<b>0 432 133 862</b>
50 00 693 243	<b>0 432 191 683</b>
50 00 694 275	<b>0 432 191 694</b>
50 00 694 275	<b>0 986 430 447</b>
50 00 694 846	<b>0 432 191 633</b>
50 00 694 846	<b>0 986 430 352</b>
50 00 694 851	<b>0 432 191 622</b>
50 00 694 854	<b>0 432 191 630</b>
50 00 694 854	<b>0 986 430 349</b>
50 00 785 794	<b>0 432 291 710</b>
50 00 785 794	<b>0 986 430 141</b>

50 00 785 794	<b>0 986 430 333</b>
50 00 785 857	<b>0 986 430 141</b>
50 00 789 576	<b>0 432 291 672</b>
50 00 789 576	<b>0 986 430 336</b>
50 00 790 173	<b>0 986 430 203</b>

50 00 815 460	<b>0 460 414 008</b>
50 00 815 460	<b>0 986 440 023</b>
50 00 823 060	<b>0 432 191 757</b>
50 01 013 882	<b>0 460 414 078</b>
50 01 013 882	<b>0 986 440 032</b>
50 01 824 595	<b>0 432 193 845</b>
50 01 824 595	<b>0 986 430 256</b>
50 01 824 761	<b>0 460 424 097</b>
50 01 826 791	<b>0 460 424 100</b>
50 01 830 305	<b>0 460 414 102</b>

50 01 831 440	<b>0 460 414 109</b>
50 01 831 440	<b>0 986 440 041</b>
50 01 832 099	<b>0 460 414 996</b>
50 01 832 099	<b>0 986 440 524</b>
50 01 833 363	<b>0 432 193 842</b>
50 01 834 915	<b>0 460 414 134</b>
50 01 836 652	<b>0 460 404 088</b>
50 01 836 654	<b>0 460 424 136</b>
50 01 836 654	<b>0 986 440 064</b>
50 01 836 655	<b>0 460 424 137</b>

50 01 838 468	<b>0 986 430 329</b>
50 01 838 482	<b>0 986 430 333</b>
50 01 838 485	<b>0 986 430 336</b>
50 01 838 496	<b>0 432 231 667</b>
50 01 838 496	<b>0 986 430 330</b>
50 01 838 499	<b>0 986 430 203</b>
50 01 838 502	<b>0 986 430 337</b>
50 01 838 506	<b>0 986 430 338</b>
50 01 838 515	<b>0 986 430 341</b>
50 01 838 518	<b>0 986 430 342</b>

50 01 838 535	<b>0 986 430 334</b>
50 01 838 541	<b>0 986 430 344</b>
50 01 838 551	<b>0 986 430 347</b>
50 01 838 555	<b>0 986 430 348</b>
50 01 838 558	<b>0 432 191 757</b>
50 01 838 561	<b>0 986 430 332</b>
50 01 838 564	<b>0 986 430 256</b>
50 01 838 576	<b>0 986 430 352</b>
50 01 838 613	<b>0 986 430 144</b>
50 01 838 673	<b>0 986 430 141</b>

50 01 838 684	<b>0 986 430 349</b>
50 01 842 340	<b>0 432 193 796</b>
50 01 842 340	<b>0 432 193 833</b>
50 01 842 343	<b>0 432 193 796</b>
50 01 848 031	<b>0 460 494 464</b>

50 01 848 033	<b>0 460 494 470</b>
50 01 848 043	<b>0 432 117 002</b>
50 01 848 538	<b>0 445 020 002</b>
50 01 848 538	<b>0 986 437 501</b>
50 01 849 912	<b>0 445 120 002</b>



◀ RENAULT

50 01 849 912	<b>0 986 435 501</b>	77 00 103 304	<b>0 460 484 115</b>	77 00 862 806	<b>0 986 430 269</b>	77 01 477 158	<b>0 445 115 007</b>
50 01 863 208	<b>0 432 193 816</b>	77 00 103 306	<b>0 460 484 117</b>	77 00 862 816	<b>0 432 217 258</b>	77 01 477 158	<b>0 986 435 350</b>
50 10 248 561	<b>0 986 430 329</b>	77 00 103 410	<b>0 460 494 437</b>	77 00 862 816	<b>0 986 430 269</b>	77 01 477 325	<b>0 445 110 265</b>
50 10 248 698	<b>0 432 231 667</b>	77 00 103 411	<b>0 460 494 438</b>	77 00 868 831	<b>0 432 217 285</b>	82 00 010 074	<b>0 445 110 038</b>
50 10 248 698	<b>0 986 430 330</b>	77 00 103 412	<b>0 460 494 439</b>	77 00 870 130	<b>0 460 414 993</b>	82 00 010 074	<b>0 986 435 016</b>
50 10 258 083	<b>0 432 131 771</b>	77 00 103 413	<b>0 460 494 440</b>	77 00 870 130	<b>0 986 440 523</b>	82 00 010 075	<b>0 445 110 063</b>
50 10 258 090	<b>0 432 131 767</b>	77 00 103 739	<b>0 460 484 122</b>	77 00 870 309	<b>0 460 414 993</b>	82 00 010 075	<b>0 986 435 075</b>
50 10 258 090	<b>0 986 430 347</b>	77 00 104 016	<b>0 445 010 018</b>	77 00 870 309	<b>0 986 440 523</b>	82 00 010 076	<b>0 445 010 028</b>
50 10 258 322	<b>0 432 131 742</b>	77 00 104 016	<b>0 986 437 010</b>	77 00 872 697	<b>0 460 494 333</b>	82 00 010 076	<b>0 986 437 015</b>
50 10 258 324	<b>0 432 131 742</b>	77 00 104 420	<b>0 460 494 435</b>	77 00 872 698	<b>0 460 494 332</b>	82 00 017 377	<b>0 986 437 302</b>
50 10 258 484	<b>0 432 131 732</b>	77 00 104 421	<b>0 460 494 436</b>	77 00 874 094	<b>0 460 484 033</b>	82 00 037 472	<b>0 445 010 031</b>
50 10 258 490	<b>0 432 131 748</b>	77 00 104 422	<b>0 460 494 437</b>	77 00 874 094	<b>0 986 440 238</b>	82 00 037 472	<b>0 986 437 301</b>
50 10 258 560	<b>0 432 131 761</b>	77 00 104 423	<b>0 460 494 438</b>	77 00 874 179	<b>0 460 494 378</b>	82 00 041 766	<b>0 445 010 033</b>
50 10 258 876	<b>0 432 131 714</b>	77 00 104 424	<b>0 460 494 439</b>	77 00 874 816	<b>0 460 494 393</b>	82 00 041 766	<b>0 986 437 302</b>
50 10 258 876	<b>0 986 430 511</b>	77 00 104 425	<b>0 460 494 440</b>	77 00 874 816	<b>0 986 440 205</b>	82 00 047 506	<b>0 432 193 563</b>
50 10 284 085	<b>0 432 193 833</b>	77 00 105 072	<b>0 460 484 129</b>	77 00 875 035	<b>0 432 193 754</b>	82 00 047 509	<b>0 432 193 564</b>
50 10 284 086	<b>0 432 193 796</b>	77 00 106 785	<b>0 460 484 134</b>	77 00 875 036	<b>0 432 193 753</b>	82 00 048 193	<b>0 460 414 983</b>
50 10 284 955	<b>0 432 193 528</b>	77 00 107 165	<b>0 445 110 021</b>	77 00 875 627	<b>0 432 217 292</b>	82 00 055 072	<b>0 445 010 031</b>
50 10 284 955	<b>0 432 193 671</b>	77 00 107 165	<b>0 986 435 007</b>	77 01 035 658	<b>0 460 494 292</b>	82 00 055 072	<b>0 445 010 075</b>
50 10 295 113	<b>0 432 191 616</b>	77 00 107 166	<b>0 460 484 136</b>	77 01 058 123	<b>0 445 010 094</b>	82 00 055 072	<b>0 986 437 301</b>
50 10 295 113	<b>0 986 430 348</b>	77 00 107 167	<b>0 460 494 454</b>	77 01 103 739	<b>0 460 484 122</b>	82 00 061 475	<b>0 460 414 982</b>
50 10 323 342	<b>0 432 191 560</b>	77 00 107 169	<b>0 460 494 452</b>	77 01 352	<b>0 460 494 332</b>	82 00 084 534	<b>0 445 110 084</b>
50 10 323 837	<b>0 432 193 770</b>	77 00 107 170	<b>0 460 494 451</b>	77 01 352 925	<b>0 460 494 438</b>	82 00 100 272	<b>0 445 110 110</b>
50 10 330 262	<b>0 432 191 586</b>	77 00 107 171	<b>0 460 494 450</b>	77 01 352 927	<b>0 460 414 112</b>	82 00 100 272	<b>0 986 435 080</b>
50 10 339 605	<b>0 432 131 683</b>	77 00 107 172	<b>0 460 494 449</b>	77 01 352 927	<b>0 986 440 042</b>	82 00 100 696	<b>0 445 110 109</b>
50 10 412 093	<b>0 445 120 003</b>	77 00 110 395	<b>0 460 414 988</b>	77 01 352 928	<b>0 460 494 436</b>	82 00 100 696	<b>0 986 435 100</b>
50 10 412 093	<b>0 986 435 524</b>	77 00 110 395	<b>0 986 440 520</b>	77 01 352 932	<b>0 460 494 333</b>	82 00 101 135	<b>0 445 110 087</b>
50 10 437 223	<b>0 432 193 534</b>	77 00 110 396	<b>0 432 193 643</b>	77 01 352 933	<b>0 460 414 996</b>	82 00 101 135	<b>0 986 435 079</b>
50 10 450 233	<b>0 432 131 668</b>	77 00 110 396	<b>0 432 193 644</b>	77 01 352 933	<b>0 986 440 524</b>	82 00 108 225	<b>0 445 010 075</b>
50 10 450 433	<b>0 986 435 531</b>	77 00 110 397	<b>0 432 193 643</b>	77 01 352 937	<b>0 460 494 435</b>	82 00 112 289	<b>0 445 110 102</b>
50 10 450 532	<b>0 445 120 012</b>	77 00 110 397	<b>0 432 193 644</b>	77 01 352 940	<b>0 986 440 149</b>	82 00 121 637	<b>0 445 110 134</b>
50 10 450 532	<b>0 986 435 525</b>	77 00 111 010	<b>0 445 010 018</b>	77 01 352 941	<b>0 460 484 114</b>	82 00 146 357	<b>0 445 110 141</b>
50 10 450 533	<b>0 445 120 016</b>	77 00 111 010	<b>0 986 437 010</b>	77 01 352 950	<b>0 460 494 292</b>	82 00 146 357	<b>0 986 435 086</b>
50 10 450 533	<b>0 986 435 531</b>	77 00 111 014	<b>0 445 110 021</b>	77 01 352 951	<b>0 460 414 993</b>	82 00 170 377	<b>0 445 010 033</b>
50 10 450 726	<b>0 445 020 009</b>	77 00 112 880	<b>0 432 193 610</b>	77 01 352 951	<b>0 986 440 523</b>	82 00 171 173	<b>0 445 110 144</b>
50 10 450 726	<b>0 445 020 010</b>	77 00 112 883	<b>0 432 193 611</b>	77 01 352 955	<b>0 460 484 044</b>	82 00 186 534	<b>0 445 010 087</b>
50 10 450 952	<b>0 445 020 012</b>	77 00 114 070	<b>0 460 414 984</b>	77 01 366 479	<b>0 460 494 189</b>	82 00 198 733	<b>0 445 110 127</b>
50 10 477 370	<b>0 445 120 009</b>	77 00 300 670	<b>0 460 484 119</b>	77 01 366 930	<b>0 460 414 081</b>	82 00 211 430	<b>0 445 010 081</b>
50 10 477 499	<b>0 445 120 014</b>	77 00 743 107	<b>0 986 430 198</b>	77 01 366 930	<b>0 986 440 033</b>	82 00 212 715	<b>0 445 110 021</b>
50 10 477 499	<b>0 986 435 515</b>	77 00 854 303	<b>0 432 217 227</b>	77 01 367 936	<b>0 460 414 112</b>	82 00 216 412	<b>0 445 110 150</b>
50 10 477 874	<b>0 445 120 019</b>	77 00 854 359	<b>0 986 430 268</b>	77 01 468 915	<b>0 460 414 996</b>	82 00 228 225	<b>0 445 110 150</b>
50 10 477 874	<b>0 986 435 523</b>	77 00 855 240	<b>0 986 430 270</b>	77 01 468 915	<b>0 986 440 524</b>	82 00 228 225	<b>0 986 435 124</b>
50 10 550 956	<b>0 445 120 019</b>	77 00 855 938	<b>0 460 484 044</b>	77 01 471 242	<b>0 460 404 090</b>	82 00 229 004	<b>0 445 010 087</b>
50 10 550 956	<b>0 986 435 523</b>	77 00 857 674	<b>0 986 430 270</b>	77 01 471 573	<b>0 460 404 097</b>	82 00 238 528	<b>0 445 110 146</b>
50 10 553 638	<b>0 445 020 024</b>	77 00 858 109	<b>0 460 494 332</b>	77 01 471 679	<b>0 460 424 148</b>	82 00 238 528	<b>0 986 435 007</b>
50 10 553 948	<b>0 445 020 035</b>	77 00 858 110	<b>0 460 494 333</b>	77 01 472 093	<b>0 460 424 147</b>	82 00 239 421	<b>0 445 110 134</b>
501550955	<b>0 986 435 515</b>	77 00 858 845	<b>0 460 494 393</b>	77 01 472 093	<b>0 986 440 066</b>	82 00 246 722	<b>0 445 010 081</b>
501550956	<b>0 986 435 523</b>	77 00 858 845	<b>0 986 440 205</b>	77 01 472 094	<b>0 460 424 146</b>	82 00 273 891	<b>0 445 110 230</b>
60 01 040 565	<b>0 986 440 149</b>	77 00 858 895	<b>0 432 217 285</b>	77 01 472 094	<b>0 986 440 065</b>	82 00 273 891	<b>0 986 435 124</b>
77 00 100 959	<b>0 432 217 307</b>	77 00 861 872	<b>0 986 440 205</b>	77 01 474 032	<b>0 445 110 063</b>	82 00 279 059	<b>0 445 110 160</b>
77 00 101 016	<b>0 445 010 018</b>	77 00 862 182	<b>0 986 430 267</b>	77 01 474 032	<b>0 986 435 075</b>	82 00 279 059	<b>0 986 435 098</b>
77 00 101 016	<b>0 986 437 010</b>	77 00 862 258	<b>0 432 217 258</b>	77 01 474 043	<b>0 460 494 484</b>	82 00 283 583	<b>0 445 110 160</b>
77 00 102 209	<b>0 460 494 443</b>	77 00 862 258	<b>0 986 430 269</b>	77 01 476 567	<b>0 445 115 007</b>	82 00 283 583	<b>0 986 435 098</b>
77 00 102 444	<b>0 460 494 443</b>	77 00 862 658	<b>0 460 494 327</b>	77 01 476 567	<b>0 986 435 350</b>	82 00 296 279	<b>0 445 110 178</b>
77 00 103 303	<b>0 460 484 114</b>	77 00 862 806	<b>0 432 217 258</b>	77 01 477 040	<b>0 445 110 261</b>	82 00 340 063	<b>0 445 010 099</b>



82 00 340 063	<b>0 986 437 355</b>
82 00 340 068	<b>0 445 115 007</b>
82 00 340 068	<b>0 986 435 350</b>
82 00 342 594	<b>0 445 010 087</b>
82 00 367 121	<b>0 445 010 075</b>

82 00 372 388	<b>0 445 010 087</b>
82 00 381 629	<b>0 445 110 229</b>
82 00 389 369	<b>0 445 110 230</b>
82 00 389 369	<b>0 986 435 124</b>
82 00 409 390	<b>0 445 010 099</b>

82 00 409 390	<b>0 986 437 355</b>
82 00 409 395	<b>0 445 115 022</b>
82 00 409 398	<b>0 445 115 007</b>
82 00 409 398	<b>0 986 435 350</b>
82 00 444 808	<b>0 445 110 261</b>

82 00 456 693	<b>0 445 010 075</b>
82 00 457 039	<b>0 445 010 033</b>
82 00 461 506	<b>0 445 010 075</b>
82 00 461 506	<b>0 445 010 081</b>
82 00 484 403	<b>0 445 110 265</b>

82 00 484 408	<b>0 445 110 261</b>
82 00 503 229	<b>0 445 010 140</b>
82 00 505 056	<b>0 445 115 007</b>
82 00 505 056	<b>0 986 435 350</b>
82 00 506 550	<b>0 445 115 022</b>

82 00 524 701	<b>0 445 010 148</b>
82 00 535 108	<b>0 445 110 280</b>
82 00 546 112	<b>0 445 010 099</b>
82 00 546 112	<b>0 986 437 355</b>
82 00 549 058	<b>0 445 110 102</b>

82 00 549 063	<b>0 445 110 141</b>
82 00 549 067	<b>0 445 110 087</b>
82 00 549 067	<b>0 986 435 079</b>
82 00 564 112	<b>0 445 010 099</b>
82 00 564 112	<b>0 986 437 355</b>

82 00 565 450	<b>0 445 115 047</b>
82 00 586 851	<b>0 445 010 033</b>
82 00 586 856	<b>0 445 010 081</b>
82 00 606 383	<b>0 445 110 280</b>
82 00 613 055	<b>0 445 010 033</b>

82 00 613 056	<b>0 445 010 081</b>
82 00 659 759	<b>0 445 010 075</b>
82 00 659 766	<b>0 445 010 087</b>
82 00 679 828	<b>0 445 010 170</b>
82 00 680 077	<b>0 445 010 099</b>

82 00 680 077	<b>0 986 437 355</b>
82 00 754 783	<b>0 445 010 295</b>
82 00 784 019	<b>0 445 110 328</b>
82 00 801 679	<b>0 445 010 148</b>
82 00 803 375	<b>0 445 010 099</b>

82 00 803 375	<b>0 986 437 355</b>
82 00 804 288	<b>0 445 010 170</b>
82 00 804 536	<b>0 445 115 007</b>
82 00 804 536	<b>0 986 435 350</b>
82 00 804 554	<b>0 445 115 022</b>

82 00 839 866	<b>0 445 010 351</b>
82 00 912 052	<b>0 445 110 375</b>
82 00 928 978	<b>0 445 110 141</b>
82 00 928 996	<b>0 445 110 087</b>
82 00 934 657	<b>0 445 010 223</b>

82 00 936 736	<b>0 445 110 084</b>
82 00 936 740	<b>0 445 110 102</b>
82 00 945 033	<b>0 445 010 218</b>
82 00 950 483	<b>0 445 010 351</b>
82 00 954 113	<b>0 445 010 351</b>

82 01 024 002	<b>0 445 010 351</b>
82 01 043 626	<b>0 445 110 084</b>
82 01 089 213	<b>0 445 010 295</b>
82 01 891 506	<b>0 445 010 225</b>

## ROVER

ERR 1299	<b>0 460 414 159</b>
ERR 3339	<b>0 432 193 835</b>
ERR 3339 E	<b>0 432 193 835</b>

ERR 4046	<b>0 460 414 099</b>
ERR 4419	<b>0 460 414 098</b>
ERR 4419	<b>0 986 440 038</b>
ERR 5056	<b>0 460 414 111</b>
ERR 5533	<b>0 460 414 118</b>

ERR 5634	<b>0 460 404 973</b>
ERR 5634	<b>0 986 440 507</b>
ERR 5635	<b>0 432 193 701</b>
ERR 6217	<b>0 432 193 700</b>
ERR 6380	<b>0 460 414 118</b>

ERR 6381	<b>0 460 414 992</b>
ERR 6381	<b>0 986 440 522</b>
ERR 6580	<b>0 460 414 118</b>
ERR 6727	<b>0 460 414 991</b>
ERR 7299	<b>0 460 414 159</b>

ETC 8412	<b>0 432 193 879</b>
ETC 8412 E	<b>0 432 193 879</b>
LR 0013 20	<b>0 445 010 367</b>
LR 0013 25	<b>0 445 115 042</b>
LR 0013 25	<b>0 986 435 362</b>

LR 0066 63	<b>0 445 010 367</b>
LR 013180	<b>0 445 010 614</b>
LR 019605	<b>0 445 010 662</b>
LR 022335	<b>0 445 116 043</b>
LR 023597	<b>0 445 010 662</b>

LR 027564	<b>0 445 010 662</b>
MKG 1002 70	<b>0 445 110 030</b>
MKG 1002 70	<b>0 986 435 011</b>
MSC 1003 70	<b>0 432 193 819</b>
MSC 1003 70	<b>0 432 193 820</b>

MSC 1003 80	<b>0 432 193 819</b>
MSC 1003 80	<b>0 432 193 820</b>
MSC 1005 00	<b>0 432 193 819</b>
MSC 1005 10	<b>0 432 193 820</b>
MSC 1006 10	<b>0 432 193 700</b>

MSC 1006 20	<b>0 432 193 701</b>
MSC 1007 60	<b>0 432 193 557</b>
MSC 1007 60	<b>0 432 193 571</b>
MSC 1007 70	<b>0 432 193 601</b>
MSR 0000 10	<b>0 445 010 009</b>

MSR 1003 10	<b>0 470 004 005</b>
MSR 1003 10	<b>0 986 444 503</b>
MSR 1003 20	<b>0 445 010 011</b>
MSR 1003 20	<b>0 986 437 006</b>

## RUGGERINI

644 30	<b>0 432 193 887</b>
644 40	<b>0 432 291 657</b>
644 56	<b>0 432 193 883</b>

644 65	<b>0 432 193 870</b>
--------	----------------------

## RVI (RENAULT VEHICULES IND.)

50 00 592 825	<b>0 432 281 695</b>
50 00 659 162	<b>0 432 281 708</b>

50 00 691 225	<b>0 432 131 823</b>
50 01 838 518	<b>0 432 281 695</b>
50 01 838 541	<b>0 432 231 741</b>
50 01 860 115	<b>0 414 755 006</b>
50 10 284 908	<b>0 414 755 003</b>

50 10 284 955	<b>0 432 191 319</b>
50 10 284 955	<b>0 432 191 528</b>
50 10 295 113	<b>0 432 191 616</b>
50 10 412 093	<b>0 986 435 524</b>
50 10 437 223	<b>0 432 193 534</b>

50 10 477 499	<b>0 986 435 515</b>
50 10 477 874	<b>0 445 120 084</b>
50 10 550 955	<b>0 986 435 515</b>
50 10 550 956	<b>0 445 120 019</b>
50 10 550 956	<b>0 986 435 523</b>

50 10 553 948	<b>0 445 020 062</b>
74 20 806 011	<b>0 445 120 064</b>
74 20 806 011	<b>0 986 435 529</b>
74 21 002 997	<b>0 986 440 102</b>
74 21 006 073	<b>0 445 120 074</b>

74 21 006 084 HA	<b>0 445 120 074</b>
74 21 006 085	<b>0 445 120 064</b>
74 21 006 086	<b>0 445 120 064</b>
74 21 006 086	<b>0 986 435 529</b>
74 21 006 086	<b>0 986 435 534</b>

74 21 049 696	<b>0 445 010 136</b>
74 85 001 660	<b>0 445 110 168</b>
74 85 003 064	<b>0 986 440 102</b>
74 85 003 175	<b>0 986 445 008</b>
74 85 003 176	<b>0 986 445 001</b>

74 85 124 827	<b>0 445 010 136</b>
74 85 128 252	<b>0 445 110 141</b>
74 85 129 393	<b>0 445 010 136</b>
77 01 058 110	<b>0 445 110 169</b>
77 01 061 083	<b>0 445 110 168</b>

77 01 061 090	<b>0 445 110 169</b>
77 01 471 242	<b>0 460 404 090</b>
77 01 473 630	<b>0 445 110 102</b>
77 01 473 631	<b>0 445 110 087</b>
77 01 473 631	<b>0 986 435 079</b>

77 01 474 813	<b>0 445 110 141</b>
77 01 474 813	<b>0 986 435 086</b>

## SAAB (SAAB AUTOMOBILE AB)

09202067	<b>0 986 444 045</b>
24451341	<b>0 986 444 045</b>

47 73 206	<b>0 470 504 004</b>
847 559	<b>0 432 191 834</b>
91 17 808	<b>0 432 193 688</b>
92 00 844	<b>0 432 193 570</b>
92 02 474	<b>0 432 193 569</b>

93166812	<b>0 986 444 045</b>
93171119	<b>0 470 504 206</b>
93171119	<b>0 986 444 045</b>
93188709	<b>0 445 010 097</b>
93188709	<b>0 986 437 025</b>

95 42 887	<b>0 432 193 569</b>
-----------	----------------------

## SAEM

09 202 065	<b>0 986 444 046</b>
12 992 707	<b>0 986 444 046</b>
12 992 763	<b>0 986 444 037</b>

55 352 661	<b>0 986 444 030</b>
93 166 813	<b>0 986 444 046</b>
93 173 725	<b>0 986 444 046</b>

## SAVIEM

00 25 851 058	<b>0 432 291 819</b>
50 00 785 794	<b>0 432 291 710</b>

## SCANIA

0574364	<b>0 986 441 101</b>
0574368	<b>0 986 441 107</b>
0574369	<b>0 986 441 108</b>

◀ SCANIA

0574380	<b>0 986 441 101</b>
0574381	<b>0 986 441 107</b>
0574382	<b>0 986 441 108</b>
1107959	<b>0 432 131 871</b>
1119126	<b>0 432 131 844</b>

1302561	<b>0 432 131 846</b>
1302738	<b>0 432 131 848</b>
1303806	<b>0 432 131 824</b>
1303806	<b>0 432 131 843</b>
1303806	<b>0 432 131 846</b>

1304238	<b>0 432 131 850</b>
1304238	<b>0 986 430 031</b>
1318812	<b>0 432 131 850</b>
1318812	<b>0 986 430 031</b>
1327374	<b>0 432 131 824</b>

1327376	<b>0 432 131 825</b>
1338083	<b>0 432 231 691</b>
1340592	<b>0 432 131 812</b>
1340655	<b>0 432 131 807</b>
1341480	<b>0 432 131 813</b>

1342165	<b>0 432 131 814</b>
1351806	<b>0 432 131 783</b>
1353117	<b>0 432 131 789</b>
1358965	<b>0 432 131 773</b>
1358965	<b>0 986 430 385</b>

1358966	<b>0 432 131 773</b>
1358966	<b>0 986 430 385</b>
1364499	<b>0 432 131 758</b>
1364499	<b>0 986 430 382</b>
1365391	<b>0 432 131 773</b>

1365391	<b>0 986 430 385</b>
1369708	<b>9 430 082 757</b>
1372541	<b>0 432 131 756</b>
1373002	<b>0 432 131 758</b>
1373002	<b>0 986 430 382</b>

1375913	<b>0 432 131 751</b>
1375913	<b>0 986 430 387</b>
1375914	<b>0 432 131 750</b>
1377573	<b>0 432 131 764</b>
1381219	<b>0 432 131 744</b>

1382121	<b>0 414 701 005</b>
1383222	<b>0 432 131 724</b>
1384169	<b>0 432 131 750</b>
1384170	<b>0 432 131 751</b>
1384170	<b>0 986 430 387</b>

1386852	<b>0 432 131 711</b>
1387056	<b>0 432 131 703</b>
1387056	<b>0 986 430 390</b>
1391028	<b>0 432 131 713</b>
1391030	<b>0 432 131 712</b>

1392130	<b>0 432 133 827</b>
1394528	<b>0 432 131 709</b>
1394538	<b>0 432 131 709</b>
1397338	<b>0 432 191 494</b>
1397340	<b>0 432 191 495</b>

1404009	<b>0 432 131 686</b>
1404013	<b>0 432 131 674</b>
1404591	<b>0 432 131 692</b>
1404592	<b>0 432 131 691</b>
1408335	<b>0 414 701 005</b>

1408335	<b>0 986 441 101</b>
1409193	<b>0 414 701 008</b>
1409193	<b>0 986 441 108</b>
1412614	<b>0 432 131 687</b>
1420276	<b>0 432 131 684</b>

1420379	<b>0 414 701 007</b>
1420379	<b>0 986 441 107</b>
1421380	<b>0 414 701 016</b>
1422540	<b>0 432 131 675</b>
1424462	<b>0 414 701 005</b>

1424462	<b>0 986 441 101</b>
1425077	<b>0 414 701 005</b>
1425077	<b>0 986 441 101</b>
1428273	<b>0 414 701 005</b>
1428273	<b>0 986 441 101</b>

1433445	<b>0 432 131 664</b>
1434121	<b>0 432 191 464</b>
1434122	<b>0 432 191 465</b>
1434235	<b>F 000 439 012</b>
1440577	<b>0 414 701 017</b>

1440577	<b>0 414 701 025</b>
1440577	<b>0 986 441 114</b>
1440578	<b>0 414 701 018</b>
1440578	<b>0 414 701 026</b>
1440579	<b>0 414 701 019</b>

1440579	<b>0 414 701 027</b>
1440579	<b>0 986 441 115</b>
1440580	<b>0 414 701 020</b>
1440580	<b>0 414 701 028</b>
1440580	<b>0 986 441 116</b>

1454161	<b>0 414 701 005</b>
1454161	<b>0 986 441 101</b>
1455860	<b>0 414 701 007</b>
1455860	<b>0 986 441 107</b>
1455861	<b>0 414 701 008</b>

1455861	<b>0 986 441 108</b>
1455862	<b>0 414 701 016</b>
1478643	<b>0 414 701 030</b>
1487472	<b>0 414 701 035</b>
1497364	<b>0 414 701 005</b>

1497364	<b>0 986 441 101</b>
1497385	<b>0 414 701 007</b>
1497385	<b>0 986 441 107</b>
1497386	<b>0 414 701 008</b>
1497386	<b>0 986 441 108</b>

1497387	<b>0 414 701 016</b>
1505199	<b>0 414 701 032</b>
1522430	<b>0 432 131 624</b>
1529749	<b>0 414 701 005</b>
1529749	<b>0 986 441 101</b>

1529750	<b>0 414 701 007</b>
1529750	<b>0 986 441 107</b>
1529751	<b>0 414 701 008</b>
1529751	<b>0 986 441 108</b>
1529752	<b>0 414 701 016</b>

1548472	<b>0 414 701 038</b>
1548475	<b>0 414 701 040</b>
1730800	<b>0 414 701 036</b>
1730888	<b>0 414 701 036</b>
1732454	<b>0 432 131 616</b>

1734493	<b>0 414 701 043</b>
1749104	<b>0 414 701 042</b>
1766547	<b>0 414 701 042</b>
1766549	<b>0 414 701 037</b>
1766551	<b>0 414 701 040</b>

1766553	<b>0 414 701 038</b>
1805343	<b>0 414 701 045</b>
1805344	<b>0 414 701 044</b>
313508	<b>0 432 292 881</b>
313508	<b>0 986 430 074</b>

325707	<b>0 986 430 039</b>
349170	<b>0 986 430 031</b>
369288	<b>0 432 192 881</b>
369288	<b>0 986 430 034</b>
380807	<b>0 432 131 873</b>

380807	<b>0 986 430 030</b>
380812	<b>0 432 131 871</b>
397246	<b>0 432 192 876</b>
4772323	<b>0 432 193 688</b>
4773206	<b>0 986 444 003</b>

5341342	<b>0 470 504 206</b>
5342381	<b>0 470 504 208</b>
5342423	<b>0 432 193 570</b>
55192739	<b>0 445 110 159</b>
55198218	<b>0 445 110 243</b>

574325	<b>0 986 430 039</b>
574326	<b>0 986 430 074</b>
574331	<b>0 986 430 034</b>
574332	<b>0 986 430 031</b>
574333	<b>0 986 430 030</b>

574336	<b>0 986 430 120</b>
574337	<b>0 986 430 031</b>
574338	<b>0 432 131 843</b>
574339	<b>0 432 131 846</b>
574339	<b>0 986 430 274</b>

574341	<b>0 986 430 213</b>
574342	<b>0 986 430 212</b>
574344	<b>0 432 192 876</b>
574347	<b>0 432 131 773</b>
574347	<b>0 986 430 385</b>

574349	<b>0 986 430 382</b>
574350	<b>0 986 430 387</b>
574355	<b>0 432 131 724</b>
574359	<b>0 432 131 712</b>
574360	<b>0 986 430 390</b>

574392	<b>0 986 441 114</b>
574393	<b>0 986 441 115</b>
574394	<b>0 986 441 116</b>

SEAT

028 130 081 P	<b>0 986 440 553</b>
028 130 107 D	<b>0 986 440 557</b>
028 130 110 G	<b>0 460 484 105</b>

028 130 110 H	<b>0 460 404 971</b>
028 130 110 H	<b>0 986 440 555</b>
028 130 115 B	<b>0 986 440 567</b>
028 130 202 N	<b>0 432 193 707</b>
038 130 107 B	<b>0 460 404 972</b>

038 130 107 B	<b>0 986 440 556</b>
038 130 202 A	<b>0 432 193 594</b>
038 130 202 B	<b>0 432 193 592</b>

S.I.S.

8370 73240	<b>0 445 110 381</b>
------------	----------------------

SISU

8363 54615	<b>0 432 191 631</b>
8364 64785	<b>0 460 424 311</b>
8366 64790	<b>0 460 423 019</b>

8366 72205	<b>0 460 423 037</b>
8366 72207	<b>0 460 423 041</b>
8367 64786	<b>0 460 424 312</b>
8367 64787	<b>0 460 424 319</b>
8368 54985	<b>0 470 006 004</b>

8368 54985	<b>0 470 006 008</b>
8368 54987	<b>0 470 506 042</b>
8368 64610	<b>0 470 006 004</b>
8368 64610	<b>0 470 006 008</b>
8368 69461	<b>0 470 006 008</b>

8370 69146	<b>0 445 020 054</b>
8370 69148	<b>0 445 020 056</b>
8370 69214	<b>0 445 120 062</b>
8370 69215	<b>0 445 120 063</b>
837073713	<b>0 445 120 235</b>

8370 73731	<b>0 445 020 606</b>
------------	----------------------

SISU DIESEL

836664790	<b>0 460 423 019</b>
8366 72207	<b>0 460 423 041</b>
8367 64785	<b>0 460 424 311</b>



8367 64786	<b>0 460 424 312</b>
8367 64787	<b>0 460 424 319</b>
8367 72286	<b>0 460 424 438</b>
8370 72106	<b>0 444 022 007</b>
8370 72654	<b>0 444 022 026</b>

837073731	<b>0 445 020 606</b>
-----------	----------------------

--	--

--	--

### SKODA

028 130 115 M	<b>0 460 404 971</b>
028 130 115 M	<b>0 986 440 555</b>
038 130 107 B	<b>0 460 404 972</b>

038 130 107 B	<b>0 986 440 556</b>
---------------	----------------------

038 130 107 D	<b>0 986 440 557</b>
---------------	----------------------

038 130 201 G	<b>0 432 193 733</b>
---------------	----------------------

--	--

### SMART (MCC)

Q0001456V003	<b>0 986 437 019</b>
Q0001456V004	<b>0 445 010 273</b>
Q0001587V002	<b>0 445 110 022</b>

000 1456 V003	<b>0 986 437 019</b>
---------------	----------------------

000 1456 V004	<b>0 445 010 273</b>
---------------	----------------------

000 1587 V002	<b>0 445 110 022</b>
---------------	----------------------

--	--

### SSANGYONG

002 017 34 21	<b>0 432 217 157</b>
---------------	----------------------

003 017 29 21	<b>0 432 217 169</b>
---------------	----------------------

661 017 31 21	<b>0 432 217 157</b>
---------------	----------------------

### STEYR NUTZFAHRZEUGE AG

612 60 08 0218	<b>0 432 191 609</b>
----------------	----------------------

612 60 08 0230	<b>0 432 291 512</b>
----------------	----------------------

### STEYR (STEYR- DAIMLER-PUCH AG)

311 00 08 0125	<b>0 432 291 619</b>
----------------	----------------------

408 00 08 0065	<b>0 460 414 061</b>
----------------	----------------------

409 08 0071	<b>0 432 281 812</b>
-------------	----------------------

612 00 08 0205	<b>0 432 291 640</b>
----------------	----------------------

612 00 08 0236	<b>0 460 426 183</b>
----------------	----------------------

612 60 08 0128	<b>0 432 291 617</b>
----------------	----------------------

612 60 08 0193	<b>0 432 191 638</b>
----------------	----------------------

612 60 08 0218	<b>0 432 191 609</b>
----------------	----------------------

612 60 08 0230	<b>0 432 291 512</b>
----------------	----------------------

612 60 08 0236	<b>0 460 426 183</b>
----------------	----------------------

615 60 08 0148	<b>0 432 191 817</b>
----------------	----------------------

615 60 08 0178	<b>0 432 191 773</b>
----------------	----------------------

615 60 08 0218	<b>0 432 191 773</b>
----------------	----------------------

615 60 08 0272	<b>0 432 191 662</b>
----------------	----------------------

615 60 08 0276	<b>0 432 191 659</b>
----------------	----------------------

815 60 08 0282	<b>0 432 281 699</b>
----------------	----------------------

842 46 8920	<b>0 444 022 021</b>
-------------	----------------------

915 60 08 0148	<b>0 432 191 773</b>
----------------	----------------------

--	--

--	--

### SUZUKI

15110-84E50	<b>0 445 010 277</b>
-------------	----------------------

15110-84E51	<b>0 445 010 278</b>
-------------	----------------------

15200-67G00	<b>0 445 010 010</b>
-------------	----------------------

15200 67G00 000	<b>0 445 010 010</b>
-----------------	----------------------

15200-67G10	<b>0 445 010 021</b>
-------------	----------------------

15200 67G10 000	<b>0 445 010 021</b>
-----------------	----------------------

15200-69K00	<b>0 445 010 296</b>
-------------	----------------------

15200-69K00	<b>0 986 437 028</b>
-------------	----------------------

15200 69K00 000	<b>0 445 010 296</b>
-----------------	----------------------

15200 69K00 000	<b>0 986 437 028</b>
-----------------	----------------------

15200-86J00	<b>0 445 010 278</b>
-------------	----------------------

15210-67JG2-000	<b>0 445 010 087</b>
-----------------	----------------------

15210-67JH1-000	<b>0 445 010 148</b>
-----------------	----------------------

15210-67JH1-000	<b>0 445 010 218</b>
-----------------	----------------------

15310-67G00	<b>0 445 110 044</b>
-------------	----------------------

15310-67G00	<b>0 986 435 003</b>
-------------	----------------------

15310 67G00 000	<b>0 445 110 044</b>
-----------------	----------------------

15310 67G00 000	<b>0 986 435 003</b>
-----------------	----------------------

15310-67G10	<b>0 445 110 044</b>
-------------	----------------------

15310-67G12	<b>0 445 110 044</b>
-------------	----------------------

15310-67G12	<b>0 986 435 003</b>
-------------	----------------------

15310 67G12 000	<b>0 445 110 044</b>
-----------------	----------------------

15310 67G12 000	<b>0 986 435 003</b>
-----------------	----------------------

15310-67G30	<b>0 445 110 057</b>
-------------	----------------------

15310-67G30	<b>0 986 435 093</b>
-------------	----------------------

15310 67G30 000	<b>0 445 110 057</b>
-----------------	----------------------

15310 67G30 000	<b>0 986 435 093</b>
-----------------	----------------------

15310 67JG0 000	<b>0 445 110 230</b>
-----------------	----------------------

15310 67JG0 000	<b>0 986 435 124</b>
-----------------	----------------------

15310-69K00	<b>0 445 110 239</b>
-------------	----------------------

15310-69K00	<b>0 986 435 122</b>
-------------	----------------------

15310 69K00 000	<b>0 445 110 239</b>
-----------------	----------------------

15310 69K00 000	<b>0 986 435 122</b>
-----------------	----------------------

15310-80KA0-000	<b>0 445 110 328</b>
-----------------	----------------------

15710-79J50	<b>0 445 110 276</b>
-------------	----------------------

15710-79J50	<b>0 986 435 148</b>
-------------	----------------------

15710 79J50 000	<b>0 445 110 276</b>
-----------------	----------------------

15710 79J50 000	<b>0 986 435 148</b>
-----------------	----------------------

15710-84E60	<b>0 445 110 083</b>
-------------	----------------------

15710 84E60 000	<b>0 445 110 083</b>
-----------------	----------------------

15710-86J20	<b>0 445 110 316</b>
-------------	----------------------

15710 86J20 000	<b>0 445 110 316</b>
-----------------	----------------------

### TALBOT

93 501 010 80	<b>0 460 494 121</b>
---------------	----------------------

93 501 091 80	<b>0 986 430 015</b>
---------------	----------------------

93 501 091 80	<b>0 986 430 028</b>
---------------	----------------------

93 501 380 80	<b>0 986 430 010</b>
---------------	----------------------

93 510 454 80	<b>0 986 430 028</b>
---------------	----------------------

96 004 017 80	<b>0 986 430 028</b>
---------------	----------------------

96 011 913 80	<b>0 986 430 028</b>
---------------	----------------------

96 014 904 80	<b>0 460 494 223</b>
---------------	----------------------

### TATA (TELCO)

252501160123	<b>F 002 C8Z 860</b>
--------------	----------------------

### TOYOTA

22100 ON010	<b>0 445 010 113</b>
-------------	----------------------

22100 ON011	<b>0 445 010 113</b>
-------------	----------------------

22100 ON020	<b>0 445 010 134</b>
-------------	----------------------

22100 OW010	<b>0 445 010 214</b>
-------------	----------------------

22100 OW010	<b>0 445 010 258</b>
-------------	----------------------

22100 33011	<b>0 445 010 112</b>
-------------	----------------------

22100 33020	<b>0 445 010 114</b>
-------------	----------------------

22100 33030	<b>0 445 010 106</b>
-------------	----------------------

2210033030C	<b>0 445 010 106</b>
-------------	----------------------

22100 33040	<b>0 445 010 105</b>
-------------	----------------------

22100 33050	<b>0 445 010 214</b>
-------------	----------------------

23670 ON010	<b>0 445 110 153</b>
-------------	----------------------

23670 ON010	<b>0 445 110 154</b>
-------------	----------------------

23670 ON020	<b>0 445 110 214</b>
-------------	----------------------

23670 ON030	<b>0 445 110 262</b>
-------------	----------------------

23670 ON040	<b>0 445 110 262</b>
-------------	----------------------

23670 OW010	<b>0 445 116 009</b>
-------------	----------------------

23670 OW010	<b>0 445 116 053</b>
-------------	----------------------

23670 OW020	<b>0 445 116 054</b>
-------------	----------------------

23670 33010B	<b>0 445 110 215</b>
--------------	----------------------

23670 33030	<b>0 445 110 215</b>
-------------	----------------------

23670 33040	<b>0 445 110 227</b>
-------------	----------------------

23670 33050	<b>0 445 116 009</b>
-------------	----------------------

23670 33050	<b>0 445 116 052</b>
-------------	----------------------

23670 33051	<b>0 445 116 009</b>
-------------	----------------------

23670 33060	<b>0 445 116 044</b>
-------------	----------------------

23670 366F0	<b>0 445 110 227</b>
-------------	----------------------

### TURK TRAKTOR

5099371	<b>0 432 191 231</b>
---------	----------------------

### UD TRUCKS / NISSAN-DIESEL

16600 J2000	<b>9 430 610 308</b>
-------------	----------------------

16600 J5570	<b>9 430 610 322</b>
-------------	----------------------

16600 J5571	<b>9 430 610 318</b>
-------------	----------------------

16600 J6500	<b>9 430 610 323</b>
-------------	----------------------

16600 L9200	<b>9 430 610 052</b>
-------------	----------------------

16600 T7200	<b>9 430 610 056</b>
-------------	----------------------

16600 T7225	<b>9 430 610 054</b>
-------------	----------------------

16600 T9000	<b>9 430 610 004</b>
-------------	----------------------

16600 T9300	<b>9 430 610 915</b>
-------------	----------------------

16600 T9301	<b>9 430 610 988</b>
-------------	----------------------

16600 T9302	<b>9 430 610 999</b>
-------------	----------------------

16600 T9303	<b>9 430 611 044</b>
-------------	----------------------

16600 V1300	<b>9 430 613 166</b>
-------------	----------------------

16600 V6600	<b>9 430 610 355</b>
-------------	----------------------

16600 V6625	<b>9 430 610 364</b>
-------------	----------------------

16600 Y8400	<b>9 430 610 003</b>
-------------	----------------------

16600 Y8401	<b>9 430 610 038</b>
-------------	----------------------

16600 Y8425	<b>9 430 613 164</b>
-------------	----------------------

16600 Z0000	<b>9 430 610 962</b>
-------------	----------------------

16600 Z0001	<b>9 430 611 016</b>
-------------	----------------------

16600 Z0002	<b>9 430 611 117</b>
-------------	----------------------

16600 Z0003	<b>9 430 612 952</b>
-------------	----------------------

16600 Z5503	<b>9 430 610 808</b>
-------------	----------------------

16600 Z5505	<b>9 430 610 839</b>
-------------	----------------------

16600 Z5519	<b>9 430 610 044</b>
-------------	----------------------

◀ UD TRUCKS / NISSAN-DIESEL

16600 Z5708	<b>9 430 610 222</b>	16600 95009	<b>9 430 611 048</b>	16600 97076	<b>9 430 612 779</b>	16700 02N19	<b>9 460 610 241</b>
16600 Z5709	<b>9 430 612 694</b>	16600 95011	<b>9 430 611 060</b>	16600 97077	<b>9 430 612 780</b>	16700 02N70	<b>9 460 610 416</b>
16600 Z5711	<b>9 430 610 230</b>	16600 95014	<b>9 430 611 354</b>	16600 97102	<b>9 430 612 774</b>	16700 02N72	<b>9 460 612 011</b>
16600 Z6000	<b>9 430 612 619</b>	16600 95015	<b>9 430 611 370</b>	16600 97103	<b>9 430 612 773</b>	16700 02N73	<b>9 460 610 710</b>
16600 Z6001	<b>9 430 612 620</b>	16600 95016	<b>9 430 613 016</b>	16600 97104	<b>9 430 612 790</b>	16700 02N74	<b>9 460 610 341</b>
16600 Z6002	<b>9 430 613 051</b>	16600 95018	<b>9 430 613 186</b>	16600 97105	<b>9 430 611 808</b>	16700 02N75	<b>9 460 610 735</b>
16600 Z6003	<b>9 430 612 722</b>	16600 95500	<b>9 430 611 158</b>	16600 97106	<b>9 430 610 508</b>	16700 05D10	<b>9 460 611 660</b>
16600 Z6006	<b>9 430 610 204</b>	16600 95503	<b>9 430 611 503</b>	16600 97107	<b>9 430 612 788</b>	16700 05D11	<b>9 460 611 661</b>
16600 0F000	<b>9 430 610 125</b>	16600 95504	<b>9 430 612 775</b>	16600 97110	<b>9 430 613 466</b>	16700 09W01	<b>9 460 610 051</b>
16600 0T300	<b>9 430 613 285</b>	16600 95505	<b>9 430 611 912</b>	16600 97111	<b>9 430 613 182</b>	16700 09W05	<b>9 460 610 251</b>
16600 01D00	<b>9 430 611 390</b>	16600 96003	<b>9 430 610 752</b>	16600 97112	<b>9 430 611 929</b>	16700 1S800	<b>9 460 610 826</b>
16600 01D01	<b>9 430 611 400</b>	16600 96005	<b>9 430 610 767</b>	16600 97114	<b>9 430 611 895</b>	16700 10G03	<b>9 460 610 165</b>
16600 01D02	<b>9 430 611 406</b>	16600 96008	<b>9 430 611 032</b>	16600 97115	<b>9 430 611 911</b>	16700 10H03	<b>9 460 610 256</b>
16600 01T00	<b>9 430 611 347</b>	16600 96010	<b>9 430 611 034</b>	16600 97116	<b>9 430 612 789</b>	16700 10H05	<b>9 460 610 412</b>
16600 01T01	<b>9 430 611 355</b>	16600 96011	<b>9 430 611 035</b>	16600 97117	<b>9 430 611 901</b>	16700 10T07	<b>9 460 610 242</b>
16600 01T02	<b>9 430 611 367</b>	16600 96500	<b>9 430 610 455</b>	16600 97119	<b>9 430 611 945</b>	16700 10T10	<b>9 460 610 732</b>
16600 01T20	<b>9 430 611 375</b>	16600 96504	<b>9 430 610 905</b>	16600 97164	<b>9 430 612 937</b>	16700 10T11	<b>9 460 610 388</b>
16600 01T60	<b>9 430 611 348</b>	16600 96506	<b>9 430 610 917</b>	16600 97173	<b>9 430 613 492</b>	16700 11H02	<b>9 460 610 634</b>
16600 13G00	<b>9 430 610 394</b>	16600 96508	<b>9 430 610 940</b>	16600 97174	<b>9 430 613 493</b>	16700 18G01	<b>9 460 610 653</b>
16600 17D01	<b>9 430 612 634</b>	16600 96509	<b>9 430 610 963</b>	16600 97179	<b>9 430 613 495</b>	16700 2H213	<b>9 460 611 021</b>
16600200531	<b>9 430 610 057</b>	16600 96512	<b>9 430 611 012</b>	16600 97200	<b>9 430 613 499</b>	16700 2S614	<b>9 460 611 356</b>
16600 29D00	<b>9 430 612 673</b>	16600 96513	<b>9 430 611 079</b>	16600 97201	<b>9 430 613 501</b>	16700 2X900	<b>0 470 504 034</b>
16600 36W00	<b>9 430 610 006</b>	16600 96518	<b>9 430 611 340</b>	16600 97202	<b>9 430 613 503</b>	16700 21N01	<b>9 460 610 343</b>
16600 37500	<b>9 430 611 990</b>	16600 96562	<b>9 430 611 129</b>	16610 L9200	<b>9 430 615 046</b>	16700 21T08	<b>9 460 610 436</b>
16600 37502	<b>9 430 610 002</b>	16600 96564	<b>9 430 611 141</b>	16610 Z5506	<b>9 430 615 046</b>	16700 21T12	<b>9 460 610 445</b>
16600 4K001	<b>9 430 613 718</b>	16600 96565	<b>9 430 611 152</b>	16610 Z9002	<b>9 430 615 046</b>	16700 21T13	<b>9 460 610 430</b>
16600 43G01	<b>9 430 610 405</b>	16600 96566	<b>9 430 611 153</b>	16610 90016	<b>9 430 615 048</b>	16700 24N00	<b>9 460 610 373</b>
16600 43G02	<b>9 430 610 048</b>	16600 96567	<b>9 430 611 154</b>	16700MA70B	<b>0 445 010 136</b>	16700 24N01	<b>9 460 614 311</b>
16600 43G21	<b>9 430 610 065</b>	16600 96568	<b>9 430 611 159</b>	16700MA70B	<b>0 445 020 118</b>	16700 28T04	<b>9 460 611 543</b>
16600 43G22	<b>9 430 610 065</b>	16600 96569	<b>9 430 611 171</b>	16700 R8114	<b>9 460 610 020</b>	16700 30N05	<b>9 460 610 414</b>
16600 43G23	<b>9 430 613 539</b>	16600 96577	<b>9 430 611 462</b>	16700 R8118	<b>9 460 610 248</b>	16700 30N07	<b>9 460 610 351</b>
16600 45K00	<b>9 430 612 592</b>	16600 96578	<b>9 430 611 475</b>	16700 R8302	<b>9 460 610 163</b>	16700 30N08	<b>9 460 610 352</b>
16600 45K01	<b>9 430 612 593</b>	16600 96600	<b>9 430 612 778</b>	16700 R8306	<b>9 460 610 049</b>	16700 30N09	<b>9 460 610 564</b>
16600 54T00	<b>9 430 612 484</b>	16600 96601	<b>9 430 612 777</b>	16700 R8307	<b>9 460 610 399</b>	16700 30N12	<b>9 460 610 588</b>
16600 63G01	<b>9 430 610 135</b>	16600 96602	<b>9 430 611 504</b>	16700 R8308	<b>9 460 610 050</b>	16700 31N01	<b>9 460 610 344</b>
16600 64W00	<b>9 430 610 354</b>	16600 96604	<b>9 430 611 897</b>	16700 R8309	<b>9 460 610 270</b>	16700 31N09	<b>9 460 612 890</b>
16600 9X700	<b>0 432 193 548</b>	16600 96605	<b>9 430 611 529</b>	16700 R8310	<b>9 460 610 279</b>	16700 34T03	<b>9 460 610 473</b>
16600 9X701	<b>0 432 193 548</b>	16600 96606	<b>9 430 610 509</b>	16700 R8313	<b>9 460 610 135</b>	16700 40K01	<b>9 460 611 539</b>
16600 90013	<b>9 430 611 257</b>	16600 96611	<b>9 430 611 950</b>	16700 R8315	<b>9 460 610 136</b>	16700 40K04	<b>9 460 610 673</b>
16600 90017	<b>9 430 611 258</b>	16600 97005	<b>9 430 611 289</b>	16700 R8801	<b>9 460 610 280</b>	16700 40K07	<b>9 460 610 674</b>
16600 90018	<b>9 430 611 259</b>	16600 97006	<b>9 430 611 298</b>	16700 R8802	<b>9 460 610 281</b>	16700 43G13	<b>9 460 610 325</b>
16600 90019	<b>9 430 610 053</b>	16600 97009	<b>9 430 610 753</b>	16700 R8803	<b>9 460 610 282</b>	16700 43G14	<b>9 460 610 326</b>
16600 90021	<b>9 430 610 315</b>	16600 97012	<b>9 430 610 788</b>	16700 T7208	<b>9 460 610 400</b>	16700 43G16	<b>9 460 610 327</b>
16600 90025	<b>9 430 613 163</b>	16600 97014	<b>9 430 610 814</b>	16700 T8206	<b>9 460 610 047</b>	16700 43G19	<b>9 460 610 536</b>
16600 90060	<b>9 430 610 058</b>	16600 97018	<b>9 430 610 902</b>	16700 T8212	<b>9 460 610 048</b>	16700 43G20	<b>9 460 610 538</b>
16600 90062	<b>9 430 612 976</b>	16600 97019	<b>9 430 610 083</b>	16700 T8270	<b>9 460 610 006</b>	16700 43G21	<b>9 460 610 727</b>
16600 90064	<b>9 430 611 043</b>	16600 97061	<b>9 430 611 049</b>	16700 T8271	<b>9 460 610 229</b>	16700 44G04	<b>9 460 610 314</b>
16600 90071	<b>9 430 613 160</b>	16600 97063	<b>9 430 611 089</b>	16700 T8273	<b>9 460 610 053</b>	16700 44G06	<b>9 460 610 420</b>
16600 90108	<b>9 430 613 144</b>	16600 97064	<b>9 430 611 093</b>	16700 VH202	<b>9 460 611 503</b>	16700 47N00	<b>9 460 610 734</b>
16600 95001	<b>9 430 611 281</b>	16600 97065	<b>9 430 611 344</b>	16700 VW201	<b>0 470 504 029</b>	16700 47N11	<b>9 460 610 733</b>
16600 95002	<b>9 430 610 734</b>	16600 97066	<b>9 430 611 097</b>	16700 0F005	<b>9 460 610 702</b>	16700 51H06	<b>9 460 610 571</b>
16600 95003	<b>9 430 610 968</b>	16600 97068	<b>9 430 611 388</b>	16700 0T681	<b>9 460 611 179</b>	16700 51H07	<b>9 460 610 570</b>
16600 95004	<b>9 430 610 997</b>	16600 97069	<b>9 430 611 135</b>	16700 0Y100	<b>9 460 610 965</b>	16700 51H12	<b>9 460 612 000</b>
16600 95006	<b>9 430 610 998</b>	16600 97072	<b>9 430 611 146</b>	16700 02N14	<b>9 460 610 240</b>	16700 51N20	<b>9 460 610 846</b>
16600 95008	<b>9 430 612 980</b>	16600 97073	<b>9 430 611 536</b>	16700 02N18	<b>9 460 610 243</b>	16700 54W01	<b>9 460 610 555</b>





16700 54W03	<b>9 460 610 010</b>
16700 54W04	<b>9 460 610 052</b>
16700 56T02	<b>9 460 611 937</b>
16700 80G07	<b>9 460 610 519</b>
16700 80G17	<b>9 460 610 561</b>

16700 90078	<b>9 460 610 633</b>
16713 97204	<b>9 400 613 400</b>
21360172	<b>0 444 022 029</b>

**UNIC**

000 771 354	<b>0 432 297 034</b>
061 315 024	<b>0 432 191 818</b>
4 750 405	<b>0 432 281 704</b>

61 316 336	<b>0 432 191 818</b>
984 113 207	<b>0 432 291 580</b>
98 413 207	<b>0 432 291 580</b>
98 418 590	<b>0 432 291 575</b>

**VALMET**

145 140	<b>9 430 082 289</b>
836 354 615	<b>0 432 191 631</b>

**VAUXHALL**

R1090057	<b>0 986 444 005</b>
R1590037	<b>0 986 444 001</b>
R1590040	<b>0 470 504 003</b>

R1590040	<b>0 986 444 002</b>
R1590041	<b>0 986 444 012</b>
R1590042	<b>0 986 444 500</b>
R1590043	<b>0 986 444 014</b>
R1590050	<b>0 986 444 021</b>

R1590051	<b>0 986 444 028</b>
R1590052	<b>0 986 444 029</b>
R1590054	<b>0 986 444 030</b>
R1590055	<b>0 986 444 037</b>
R1590056	<b>0 986 444 036</b>

R1590063	<b>0 986 435 102</b>
R1590064	<b>0 986 435 082</b>
R1590065	<b>0 986 435 103</b>
R1590066	<b>0 986 435 088</b>
R1590067	<b>0 986 435 104</b>

R1590068	<b>0 986 435 105</b>
R1590069	<b>0 986 435 089</b>
R1590070	<b>0 986 435 079</b>
R1590072	<b>0 986 435 075</b>
R1590073	<b>0 986 435 106</b>

R1590074	<b>0 986 435 086</b>
R1590075	<b>0 986 435 007</b>
R1590076	<b>0 986 435 095</b>
R1590077	<b>0 986 435 078</b>

**VM (MOTORI/  
STABILIMENTI MEC.)**

C5 02 0182A	<b>0 460 414 262</b>
112 061	<b>0 460 404 991</b>

15 06 2012F	<b>0 432 217 222</b>
15 06 2018F	<b>0 432 217 281</b>
15 06 2022F	<b>0 432 217 303</b>
15 06 2023F	<b>0 432 217 304</b>
15 06 2026F	<b>0 432 217 303</b>

15 06 2027F	<b>0 432 217 311</b>
15 06 2038F	<b>0 432 193 693</b>
15 06 2042F	<b>0 432 193 514</b>
15 06 2043F	<b>0 432 193 513</b>
15 06 2047F	<b>0 445 110 217</b>

15 06 2048F	<b>0 445 110 218</b>
15 06 2049F	<b>0 445 110 221</b>
15 06 2053F	<b>0 445 110 287</b>
15 06 2054F	<b>0 445 110 301</b>
15 06 2055F	<b>0 445 110 286</b>

15 06 2057F	<b>0 445 110 269</b>
15 06 2058F	<b>0 445 115 067</b>
35 00 62001F	<b>0 445 110 354</b>
35 02 2047F	<b>0 460 404 991</b>
35 02 2087F	<b>0 445 010 034</b>

35 02 2087G	<b>0 445 010 034</b>
35 02 2089F	<b>0 460 414 220</b>
35 02 2090F	<b>0 460 404 101</b>
35 02 2092F	<b>0 460 424 254</b>
35 02 2092G	<b>0 460 424 254</b>

35 02 2093F	<b>0 460 426 994</b>
35 02 2098F	<b>0 445 010 104</b>
35 02 2101F	<b>0 460 424 998</b>
35 02 2102F	<b>0 460 426 390</b>
35 02 2103F	<b>0 445 010 084</b>

35 02 2104G	<b>0 445 010 152</b>
35 02 2114F	<b>0 445 010 152</b>
35 02 2115F	<b>0 460 414 262</b>
35 02 2115H	<b>0 460 414 262</b>
35 02 2131F	<b>0 445 010 636</b>

35 06 2002F	<b>0 445 110 400</b>
44 50 10034	<b>0 445 010 034</b>
50 60 1330	<b>0 445 110 286</b>

**VOLVO**

11030650	<b>0 432 191 717</b>
11030783	<b>0 432 191 671</b>
11030859	<b>0 432 191 658</b>

11032785	<b>0 432 191 529</b>
11032785	<b>0 986 430 491</b>
11043052	<b>0 432 191 778</b>
11043052	<b>0 986 430 492</b>
111030859	<b>0 986 430 498</b>

1275496	<b>0 432 193 771</b>
1275497	<b>0 460 415 990</b>
1275497	<b>0 986 440 564</b>
1328208	<b>0 986 430 080</b>
14261266	<b>0 432 291 654</b>

1542155	<b>0 432 297 032</b>
1543753	<b>0 432 291 635</b>
1543753	<b>0 986 430 169</b>
1544090	<b>0 986 430 002</b>
1545102	<b>0 432 191 848</b>

1545102	<b>0 986 430 000</b>
1545501	<b>0 432 191 795</b>
1556157	<b>0 432 291 562</b>
1556446	<b>0 432 291 534</b>
1556446	<b>0 986 430 301</b>

1677158	<b>0 414 701 004</b>
1677158	<b>0 986 441 004</b>
20381597	<b>0 414 702 010</b>
20381597	<b>0 986 441 006</b>
20440409	<b>0 414 702 010</b>

20440409	<b>0 986 441 006</b>
20440412	<b>0 414 702 007</b>
20440412	<b>0 986 441 111</b>
20440415	<b>0 414 702 006</b>
20440415	<b>0 986 441 110</b>

20440475	<b>0 432 191 361</b>
20440675	<b>0 470 506 017</b>
20440675	<b>0 986 444 082</b>
21006085	<b>0 445 120 064</b>
21188517	<b>0 445 120 175</b>

21200982	<b>0 444 022 016</b>
2120644	<b>0 444 022 020</b>
21210636	<b>0 444 022 020</b>
21210835	<b>0 444 022 017</b>
21332695	<b>0 444 042 009</b>

21332701-P02	<b>0 444 042 009</b>
21582902	<b>0 444 022 034</b>
240339	<b>0 432 281 873</b>
240339	<b>0 986 430 064</b>
240346	<b>0 432 281 871</b>

30637375	<b>0 445 110 251</b>
30637375	<b>0 986 435 125</b>
30731567	<b>0 445 110 251</b>
30731567	<b>0 986 435 125</b>
30750282	<b>0 445 110 251</b>

30750282	<b>0 986 435 125</b>
30750283	<b>0 445 110 251</b>
30750283	<b>0 986 435 125</b>
30756094	<b>0 445 110 259</b>
30756094	<b>0 986 435 126</b>

30756125	<b>0 445 010 111</b>
30757314	<b>0 445 110 188</b>
30757314	<b>0 986 435 090</b>
30777226	<b>0 445 116 016</b>
30777314	<b>0 445 110 078</b>

30777314	<b>0 986 435 120</b>
30777346	<b>0 445 010 655</b>
30777526	<b>0 445 110 298</b>
31216724	<b>0 445 010 655</b>
31259247	<b>0 445 010 296</b>

31259247	<b>0 986 437 028</b>
31272690	<b>0 445 116 016</b>
31272690	<b>0 445 116 017</b>
31272896	<b>0 445 010 655</b>
31303238	<b>0 445 116 045</b>

31303259	<b>0 986 435 120</b>
31303409	<b>0 445 116 045</b>
31303475	<b>0 445 010 111</b>
3155044	<b>0 414 702 010</b>
3155044	<b>0 986 441 006</b>

3165869	<b>0 414 702 002</b>
3183295	<b>0 414 702 006</b>
3183295	<b>0 986 441 110</b>
3183496	<b>0 414 702 007</b>
3581194	<b>0 460 426 219</b>

3581420	<b>0 460 426 293</b>
3581433	<b>0 460 426 218</b>
3581435	<b>0 432 193 690</b>
3581451	<b>0 460 424 163</b>
3581564	<b>0 460 426 219</b>

3581642	<b>0 432 193 632</b>
3581696	<b>0 432 191 515</b>
35816965	<b>0 432 191 515</b>
3581916	<b>0 460 426 996</b>
3581917	<b>0 460 424 163</b>

3583073	<b>0 432 193 527</b>
3583074	<b>0 432 193 526</b>
3583137	<b>0 460 424 239</b>
3583207	<b>0 460 426 995</b>
3583494	<b>0 445 020 026</b>

3583618	<b>0 445 120 033</b>
3587680	<b>0 445 120 051</b>
36000269	<b>0 445 010 296</b>
36000573	<b>0 445 010 111</b>
36001127	<b>0 445 010 111</b>

36002503	<b>0 445 010 655</b>
36002662	<b>0 445 116 016</b>
38003229	<b>0 432 291 725</b>
3803229	<b>0 432 291 725</b>
3803230	<b>0 432 191 861</b>

3803231	<b>0 432 191 809</b>
3803232	<b>0 432 191 839</b>
3803233	<b>0 432 191 810</b>
3803234	<b>0 432 191 793</b>
3803236	<b>0 432 193 861</b>

3803237	<b>0 432 193 849</b>
3803239	<b>0 432 297 032</b>
3803244	<b>0 432 191 870</b>
3803255	<b>0 432 191 792</b>
3803633	<b>0 445 020 026</b>



## ◀ VOLVO

3803644	<b>0 445 010 043</b>	465872	<b>0 986 430 162</b>	8112314	<b>0 986 430 311</b>	8602936	<b>0 432 193 786</b>
3817389	<b>0 445 020 057</b>	465873	<b>0 432 191 822</b>	8112561	<b>0 432 291 534</b>	8603490	<b>0 445 110 188</b>
3825248	<b>0 432 191 614</b>	466513	<b>0 432 191 870</b>	8112746	<b>0 986 430 364</b>	8603490	<b>0 986 435 090</b>
3825737	<b>0 432 191 600</b>	466513	<b>0 986 430 033</b>	8112787	<b>0 986 430 366</b>	8603491	<b>0 445 010 089</b>
3825987	<b>0 432 291 513</b>	468217	<b>0 432 281 761</b>	8112809	<b>0 986 430 367</b>	8603491	<b>0 986 437 322</b>
3826132	<b>0 432 191 581</b>	468748	<b>0 432 191 863</b>	8112813	<b>0 986 430 368</b>	8603497	<b>0 445 010 111</b>
3826194	<b>0 432 191 567</b>	468748	<b>0 986 430 032</b>	8112818	<b>0 986 441 004</b>	860383	<b>0 432 193 861</b>
3826446	<b>0 432 191 435</b>	470115	<b>0 432 191 852</b>	8112898	<b>0 986 430 369</b>	8603893	<b>0 445 010 043</b>
3826552	<b>0 432 191 552</b>	470933	<b>0 432 191 788</b>	8113010	<b>0 986 430 370</b>	860513	<b>0 460 414 079</b>
3826662	<b>0 414 702 012</b>	470933	<b>0 986 430 167</b>	8113224	<b>0 432 193 676</b>	860556	<b>0 432 193 855</b>
3827030	<b>0 432 191 509</b>	471611	<b>0 432 191 825</b>	8113226	<b>0 986 430 591</b>	860792	<b>0 432 193 849</b>
3827185	<b>0 432 191 492</b>	471611	<b>0 986 430 163</b>	8113286	<b>0 414 702 002</b>	8608688	<b>0 445 010 043</b>
3827636	<b>0 414 702 009</b>	477504	<b>0 432 191 736</b>	8113408	<b>0 414 702 010</b>	860914	<b>0 460 414 101</b>
3827636	<b>0 986 441 109</b>	477504	<b>0 986 430 363</b>	8113408	<b>0 986 441 006</b>	860915	<b>0 460 416 049</b>
3828446	<b>0 432 191 435</b>	477816	<b>0 432 191 669</b>	8113554	<b>0 432 191 466</b>	860948	<b>0 432 297 056</b>
3828967	<b>0 432 191 492</b>	477816	<b>0 986 430 364</b>	8113845	<b>0 986 441 110</b>	861102	<b>0 460 426 218</b>
3829644	<b>0 414 702 013</b>	477885	<b>0 432 191 666</b>	8113891	<b>0 986 430 592</b>	861103	<b>0 432 191 648</b>
3830101	<b>0 432 191 425</b>	477953	<b>0 432 191 634</b>	8113893	<b>0 986 430 593</b>	861103	<b>0 432 191 684</b>
3830277	<b>0 432 191 388</b>	477953	<b>0 986 430 368</b>	8113895	<b>0 986 441 111</b>	861119	<b>0 460 414 101</b>
3830947	<b>0 432 193 535</b>	478605	<b>0 432 191 737</b>	8170569	<b>0 986 441 006</b>	861254	<b>0 460 414 106</b>
3832980	<b>0 414 702 012</b>	478605	<b>0 986 430 353</b>	819230	<b>0 470 506 017</b>	861262	<b>0 460 426 219</b>
3835257	<b>0 414 702 015</b>	478606	<b>0 432 191 715</b>	819230	<b>0 986 444 082</b>	861725	<b>0 432 193 689</b>
3835320	<b>0 432 193 523</b>	478606	<b>0 986 430 354</b>	8192362	<b>0 432 191 460</b>	8627319	<b>0 445 110 077</b>
3835958	<b>0 432 193 519</b>	478682	<b>0 432 191 621</b>	8192561	<b>0 432 191 634</b>	8627319	<b>0 445 110 078</b>
3836086	<b>0 432 291 496</b>	478682	<b>0 432 191 721</b>	8192890	<b>0 432 193 675</b>	8627319	<b>0 986 435 120</b>
3836275	<b>0 432 191 339</b>	478682	<b>0 986 430 250</b>	8192895	<b>0 432 193 676</b>	863050	<b>0 986 437 312</b>
3839372	<b>0 432 191 244</b>	4787654	<b>0 432 191 864</b>	8192932	<b>0 432 191 506</b>	8630650	<b>0 445 010 043</b>
3875688	<b>0 432 191 889</b>	479443	<b>0 432 191 730</b>	8194094	<b>0 432 191 612</b>	863927	<b>0 432 291 594</b>
3883364	<b>0 445 110 349</b>	479443	<b>0 986 430 263</b>	8194094	<b>0 986 430 369</b>	864069	<b>0 432 191 753</b>
3964829	<b>0 414 702 002</b>	4880892	<b>0 432 191 841</b>	8251785	<b>0 986 437 312</b>	8642777	<b>0 445 010 043</b>
3978713	<b>0 432 193 572</b>	4881621	<b>0 432 191 801</b>	8251786	<b>0 986 437 301</b>	8642778	<b>0 445 010 043</b>
3978724	<b>0 432 191 466</b>	4881621	<b>0 986 430 494</b>	829907	<b>0 432 291 725</b>	8642781	<b>0 445 010 043</b>
3978820	<b>0 432 191 361</b>	4881622	<b>0 432 191 802</b>	833191	<b>0 432 281 779</b>	864827	<b>0 432 191 727</b>
3978820	<b>0 432 191 405</b>	4881653	<b>0 432 191 800</b>	838289	<b>0 432 191 861</b>	865562	<b>0 432 191 685</b>
3978823	<b>0 432 191 404</b>	5001837	<b>0 986 430 033</b>	838665	<b>0 432 191 809</b>	865568	<b>0 432 291 531</b>
3978828	<b>0 432 191 402</b>	5003019	<b>0 986 430 032</b>	838682	<b>0 460 416 049</b>	8658350	<b>0 445 110 078</b>
3978866	<b>0 432 193 537</b>	5003020	<b>0 986 430 001</b>	840043	<b>0 432 191 889</b>	8658350	<b>0 986 435 120</b>
3978867	<b>0 432 193 536</b>	5003026	<b>0 986 430 000</b>	840595	<b>0 432 191 839</b>	8658351	<b>0 986 435 120</b>
420805	<b>0 432 191 724</b>	5003034	<b>0 986 430 002</b>	847559	<b>0 432 191 834</b>	8658352	<b>0 986 435 120</b>
420805	<b>0 986 430 311</b>	5003099	<b>0 986 430 162</b>	848069	<b>0 432 191 753</b>	8658353	<b>0 986 435 120</b>
422950	<b>0 432 191 770</b>	5003150	<b>0 986 430 163</b>	848228	<b>0 432 191 808</b>	865853	<b>0 432 191 677</b>
422950	<b>0 986 430 165</b>	5003151	<b>0 986 430 164</b>	848729	<b>0 432 191 807</b>	866143	<b>0 432 191 670</b>
422954	<b>0 432 191 771</b>	5003291	<b>0 986 430 167</b>	848730	<b>0 432 191 806</b>	866545	<b>0 432 291 517</b>
422954	<b>0 986 430 166</b>	5003305	<b>0 986 430 064</b>	848799	<b>0 432 191 805</b>	866882	<b>0 432 191 645</b>
424530	<b>0 432 191 815</b>	5003317	<b>0 986 430 169</b>	849457	<b>0 432 191 792</b>	8689590	<b>0 445 010 043</b>
424530	<b>0 986 430 164</b>	5003392	<b>0 986 430 165</b>	858073	<b>0 432 191 810</b>	8689591	<b>0 445 010 043</b>
425287	<b>0 432 191 719</b>	5003400	<b>0 986 430 166</b>	858299	<b>0 432 191 793</b>	8692521	<b>0 445 010 110</b>
425287	<b>0 986 430 359</b>	5003722	<b>0 986 430 089</b>	859494	<b>0 432 191 765</b>	8692521	<b>0 445 010 111</b>
425369	<b>0 432 191 710</b>	5003723	<b>0 986 430 081</b>	8601641	<b>0 460 414 984</b>	870989	<b>0 432 281 800</b>
425369	<b>0 986 430 366</b>	5003724	<b>0 986 430 080</b>	8601642	<b>0 432 193 753</b>	889635	<b>0 445 020 026</b>
425618	<b>0 432 191 635</b>	8111112	<b>0 460 415 990</b>	8601643	<b>0 432 193 754</b>	9470520	<b>0 432 193 613</b>
425618	<b>0 986 430 367</b>	8111112	<b>0 986 440 564</b>	8602383	<b>0 445 010 043</b>	9470521	<b>0 432 193 615</b>
425693	<b>0 432 191 611</b>	8111163	<b>0 432 193 771</b>	8602688	<b>0 445 010 043</b>		
425693	<b>0 986 430 370</b>	8112268	<b>0 986 430 363</b>	860270	<b>0 460 416 065</b>		
465872	<b>0 432 191 822</b>	8112303	<b>0 986 430 263</b>	8602704	<b>0 460 416 065</b>		

## VOLVO BM

11162407 **0 432 191 386**

## VOLVO CAR

8602936 **0 432 193 786**

## VOLVO PENTA

21160093 **0 414 702 016**21188520 **0 445 120 173**3803634 **0 445 120 033**3803908 **0 445 120 051**3817389 **0 445 020 057**3826552 **0 432 191 552**3887696 **0 445 120 108**478606 **0 432 191 715**861725 **0 432 193 689**

## VOLVO TRUCK

20440475 **0 432 191 361**21332695 **0 444 042 009**21332701-P02 **0 444 042 009**3583073 **0 432 193 527**3803297 **0 432 291 517**3978828 **0 432 191 402**3978866 **0 432 193 537**3978867 **0 432 193 536**8112269 **0 986 430 353**

## VW (VOLKSWAGEN)

TAE 130 201 **9 430 082 746**TAF 130 201 **9 430 082 745**TE3 130 201 **9 430 082 715**TL7 130 201 **9 430 082 296**T 121 302 01 **9 430 082 289**T 121 302 05 **9 430 082 276**T 121 302 05 **9 430 082 289**028 130 081 **0 986 440 250**028 130 081 A **0 460 494 445**028 130 081 A **0 986 440 251**028 130 081 K **0 460 484 139**028 130 081 L **0 460 484 140**028 130 081 M **0 460 484 141**028 130 081 P **0 986 440 553**028 130 081 PX **0 986 440 553**028 130 082 **0 986 440 551**028 130 082 A **0 986 440 552**028 130 082 AX **0 986 440 552**028 130 082 B **0 460 484 156**028 130 082 D **0 460 484 139**028 130 082 E **0 460 484 140**028 130 082 F **0 460 484 141**028 130 082 H **0 986 440 570**028 130 082 HX **0 986 440 570**028 130 107 **0 986 440 084**028 130 107 A **0 460 484 031**028 130 107 A **0 986 440 237**028 130 107 AX **0 986 440 237**028 130 107 D **0 986 440 557**028 130 107 DX **0 986 440 557**028 130 107 J **0 986 440 142**028 130 107 JX **0 986 440 142**028 130 107 M **0 460 484 139**028 130 107 N **0 460 484 037**028 130 107 N **0 460 484 140**028 130 107 Q **0 460 484 046**028 130 107 Q **0 986 440 239**028 130 107 QX **0 986 440 239**028 130 107 R **0 460 494 286**028 130 107 R **0 986 440 247**028 130 107 RX **0 986 440 247**028 130 107 X **0 986 440 084**028 130 108 **0 460 494 308**028 130 108 **0 986 440 248**028 130 108 G **0 460 494 346**028 130 108 G **0 986 440 249**028 130 108 GX **0 986 440 249**028 130 108 K **0 460 484 071**028 130 108 K **0 460 484 127**028 130 108 K **0 986 440 240**028 130 108 L **0 986 440 551**028 130 108 M **0 460 404 998**028 130 108 M **0 986 440 560**028 130 108 MX **0 986 440 560**028 130 108 N **0 460 484 141**028 130 108 Q **0 460 484 071**028 130 108 Q **0 460 484 127**028 130 108 Q **0 986 440 240**028 130 108 S **0 460 494 335**028 130 108 X **0 986 440 248**028 130 109 H **0 460 404 971**028 130 109 J **0 460 404 995**028 130 109 J **0 986 440 559**028 130 109 JX **0 986 440 559**028 130 109 L **0 986 440 558**028 130 109 LX **0 986 440 558**028 130 109 N **0 986 440 255**028 130 109 Q **0 986 440 568**028 130 110 B **0 986 440 255**028 130 110 BS **0 460 484 127**028 130 110 BS **0 986 440 240**028 130 110 G **0 460 484 105**028 130 110 G **0 460 484 128**028 130 110 G **0 986 440 241**028 130 110 H **0 460 404 971**028 130 110 H **0 986 440 555**028 130 110 HX **0 986 440 555**028 130 110 K **0 986 440 551**028 130 110 KX **0 986 440 551**028 130 110 M **0 986 440 558**028 130 110 MX **0 986 440 558**028 130 110 N **0 460 404 982**028 130 110 N **0 986 440 568**028 130 110 NX **0 986 440 568**028 130 110 P **0 460 404 969**028 130 110 P **0 986 440 554**028 130 110 PX **0 986 440 554**028 130 110 Q **0 986 440 237**028 130 110 QX **0 986 440 237**028 130 110 R **0 460 494 417**028 130 110 R **0 986 440 155**028 130 110 S **0 460 484 127**028 130 110 S **0 986 440 240**028 130 115 A **0 460 404 969**028 130 115 A **0 986 440 554**028 130 115 AX **0 986 440 554**028 130 115 B **0 986 440 567**028 130 115 BX **0 986 440 567**028 130 115 E **0 986 440 552**028 130 115 EX **0 986 440 552**028 130 115 G **0 460 404 970**028 130 115 G **0 986 440 568**028 130 115 GX **0 986 440 568**028 130 115 L **0 460 494 417**028 130 115 L **0 986 440 155**028 130 115 M **0 460 404 971**028 130 115 M **0 986 440 555**028 130 115 MX **0 986 440 555**028 130 115 N **0 986 440 558**028 130 115 NX **0 986 440 558**028 130 115 P **0 460 484 127**028 130 115 P **0 986 440 240**028 130 115 Q **0 460 484 128**028 130 115 Q **0 986 440 241**028 130 115 QX **0 460 484 128**028 130 115 S **0 986 440 250**028 130 115 T **0 460 494 445**028 130 115 T **0 986 440 251**028 130 116 A **0 986 440 240**028 130 116 B **0 460 484 161**028 130 201 **0 986 430 253**028 130 201 B **0 432 217 284**028 130 201 B **0 986 430 206**028 130 201 BX **0 986 430 206**028 130 201 G **0 432 193 838**028 130 201 H **0 432 193 837**028 130 201 J **0 432 193 829**028 130 201 JX **0 432 193 829**028 130 201 L **0 432 217 272**028 130 201 L **0 986 430 187**028 130 201 LX **0 986 430 187**028 130 201 S **0 432 193 744**028 130 201 T **0 432 193 746**028 130 201 X **0 986 430 253**028 130 202 G **0 432 193 733**028 130 202 H **0 432 193 704**028 130 202 J **0 432 193 702**028 130 202 M **0 432 193 709**028 130 202 N **0 432 193 707**028 130 202 P **0 432 193 695**028 130 202 Q **0 432 193 693**028 130 202 R **0 432 193 682**028 130 202 S **0 432 193 680**028 130 203 C **0 432 193 604**028 130 203 D **0 432 193 602**028 130 203 E **0 432 193 597**028 130 203 F **0 432 193 599**03G 130 073 **0 414 720 401**03G 130 073 **0 986 441 580**03G 130 073 B **0 414 720 402**03G 130 073 B **0 414 720 453**03G 130 073 B **0 986 441 580**03G 130 073 BX **0 986 441 580**03G 130 073 G **0 414 720 454**03G 130 073 G **0 986 441 566**03G 130 073 GX **0 414 720 454**03G 130 073 GX **0 986 441 566**03L 130 277 **0 445 116 029**03L 130 277 **0 986 435 360**03L 130 277 A **0 445 116 010**03L 130 277 C **0 445 116 034**03L 130 277 J **0 445 110 368**03L 130 277 N **0 445 110 437**03L 130 755 **0 445 010 546**03L 130 755 A **0 445 010 543**03L 130 755 D **0 445 010 551**03L 130 851 AX **0 986 437 410**03L 130 851 BX **0 986 437 412**03L 130 851 CX **0 986 437 420**03L 130 851 X **0 986 437 408**031 130 107 **0 460 484 111**031 130 107 B **0 460 484 033**031 130 107 B **0 986 440 238**031 130 107 BX **0 986 440 238**038 130 073 **0 414 720 002**038 130 073 **0 414 720 003**038 130 073 A **0 414 720 008**038 130 073 AA **0 414 720 028**

◀ VW

038 130 073 AA	0 986 441 557	038 130 073 BP	0 414 720 364	038 130 107 B	0 986 440 556	046 048 412 8	0 460 484 128
038 130 073 AB	0 414 720 021	038 130 073 BP	0 986 441 577	038 130 107 BX	0 986 440 556	046 049 446 7	0 460 494 467
038 130 073 AB	0 986 441 557	038 130 073 BQ	0 414 720 362	038 130 107 D	0 986 440 557	046 130 108 A	0 460 415 998
038 130 073 AC	0 414 720 029	038 130 073 BQ	0 986 441 567	038 130 107 DX	0 460 404 977	046 130 108 A	0 986 440 566
038 130 073 AC	0 986 441 554	038 130 073 BR	0 414 720 282	038 130 107 DX	0 986 440 557	046 130 108 AX	0 986 440 566
038 130 073 AD	0 414 720 023	038 130 073 BR	0 986 441 564	038 130 107 E	0 986 440 557	046 130 108 D	0 460 415 994
038 130 073 AD	0 986 441 554	038 130 073 D	0 414 720 005	038 130 107 EX	0 986 440 557	046 130 108 D	0 986 440 563
038 130 073 AE	0 414 720 218	038 130 073 F	0 414 720 007	038 130 107 H	0 986 440 561	046 130 108 DX	0 986 440 563
038 130 073 AG	0 414 720 115	038 130 073 F	0 986 441 551	038 130 107 HX	0 986 440 561	046 130 108 F	0 460 415 994
038 130 073 AG	0 986 441 559	038 130 073 G	0 414 720 013	038 130 107 J	0 986 440 561	046 130 108 F	0 986 440 563
038 130 073 AH	0 414 720 086	038 130 073 G	0 986 441 557	038 130 107 JX	0 986 440 561	046 130 108 FX	0 986 440 563
038 130 073 AH	0 986 441 553	038 130 073 H	0 414 720 014	038 130 107 KX	0 986 440 557	046 130 108 G	0 986 440 563
038 130 073 AJ	0 414 720 087	038 130 073 H	0 986 441 553	038 130 201 F	0 432 193 734	046 130 108 GX	0 986 440 563
038 130 073 AJ	0 986 441 556	038 130 073 J	0 414 720 015	038 130 201 FX	0 432 193 734	05A 130 277	0 445 117 011
038 130 073 AK	0 414 720 088	038 130 073 J	0 986 441 556	038 130 201 G	0 432 193 732	05A 130 755 A	0 445 010 663
038 130 073 AK	0 986 441 554	038 130 073 K	0 414 720 017	038 130 201 G	0 432 193 733	05A 130 755 B	0 445 010 663
038 130 073 AL	0 414 720 089	038 130 073 L	0 414 720 022	038 130 201 GX	0 432 193 732	05A 130 755 BC	0 445 010 663
038 130 073 AL	0 986 441 557	038 130 073 L	0 986 441 551	038 130 201 R	0 432 193 584	05A 130 755 C	0 445 010 663
038 130 073 AM	0 414 720 208	038 130 073 N	0 414 720 024	038 130 201 S	0 432 193 579	05A 130 755 T	0 445 010 664
038 130 073 AM	0 986 441 559	038 130 073 N	0 986 441 553	038 130 201 T	0 432 193 577	05A 130 851 X	0 986 437 414
038 130 073 AN	0 414 720 209	038 130 073 P	0 414 720 025	038 130 202	0 432 193 575	057 130 151 X	0 986 437 344
038 130 073 AN	0 986 441 560	038 130 073 P	0 986 441 556	038 130 202	0 432 193 576	057 130 276 G	0 445 110 065
038 130 073 AP	0 414 720 271	038 130 073 Q	0 414 720 019	038 130 202 A	0 432 193 594	057 130 276 H	0 445 110 113
038 130 073 AP	0 986 441 562	038 130 073 Q	0 414 720 201	038 130 202 B	0 432 193 592	057 130 277 AD	0 445 115 040
038 130 073 AQ	0 414 720 213	038 130 073 Q	0 414 720 204	038 130 202 C	0 432 193 573	057 130 277 AG	0 445 115 057
038 130 073 AQ	0 986 441 559	038 130 073 Q	0 986 441 560	038 130 202 E	0 432 193 542	057 130 277 AG	0 986 435 364
038 130 073 AR	0 414 720 214	038 130 073 R	0 414 720 018	038 130 202 K	0 432 193 544	057 130 277 AH	0 445 117 002
038 130 073 AR	0 986 441 560	038 130 073 R	0 986 441 554	041 835 31	9 430 082 276	057 130 277 AJ	0 445 117 006
038 130 073 AS	0 414 720 224	038 130 073 S	0 414 720 206	045 130 073	0 414 720 004	057 130 277 AK	0 445 115 085
038 130 073 AS	0 986 441 564	038 130 073 S	0 986 441 559	045 130 073 AA	0 414 720 084	057 130 277 AL	0 445 117 013
038 130 073 BA	0 414 720 116	038 130 079 AX	0 986 441 554	045 130 073 AA	0 986 441 555	057 130 277 K	0 445 110 132
038 130 073 BA	0 414 720 266	038 130 079 B	0 986 441 557	045 130 073 AB	0 414 720 083	057 130 277 L	0 445 110 157
038 130 073 BA	0 986 441 560	038 130 079 BX	0 986 441 557	045 130 073 AB	0 986 441 552	057 130 277 L	0 445 110 158
038 130 073 BB	0 414 720 277	038 130 079 C	0 986 441 556	045 130 073 B	0 414 720 006	057 130 277 M	0 445 110 158
038 130 073 BB	0 986 441 572	038 130 079 CX	0 986 441 556	045 130 073 B	0 414 720 010	057 130 755 AD	0 445 010 664
038 130 073 BC	0 414 720 272	038 130 079 D	0 986 441 559	045 130 073 C	0 414 720 011	057 130 755 AE	0 445 010 675
038 130 073 BC	0 986 441 569	038 130 079 DX	0 986 441 559	045 130 073 D	0 414 720 012	057 130 755 G	0 445 010 358
038 130 073 BD	0 414 720 276	038 130 079 F	0 414 720 266	045 130 073 F	0 414 720 009	057 130 755 G	0 986 437 346
038 130 073 BD	0 986 441 571	038 130 079 FX	0 986 441 560	045 130 073 F	0 986 441 552	057 130 755 H	0 445 010 340
038 130 073 BE	0 986 441 560	038 130 079 GX	0 986 441 559	045 130 073 J	0 414 720 016	057 130 755 K	0 445 010 340
038 130 073 BF	0 414 720 273	038 130 079 HX	0 986 441 562	045 130 073 J	0 986 441 555	057 130 755 L	0 445 010 340
038 130 073 BF	0 986 441 570	038 130 079 J	0 414 720 224	045 130 073 L	0 414 720 205	057 130 755 M	0 445 010 340
038 130 073 BH	0 414 720 280	038 130 079 MX	0 986 441 569	045 130 073 P	0 414 720 030	057 130 755 M	0 986 437 344
038 130 073 BH	0 986 441 575	038 130 079 NX	0 986 441 570	045 130 073 P	0 986 441 555	057 130 755 T	0 445 010 664
038 130 073 BJ	0 414 720 279	038 130 079 PX	0 986 441 572	045 130 073 Q	0 414 720 031	057 130 851 AX	0 986 437 346
038 130 073 BJ	0 986 441 574	038 130 079 QX	0 986 441 574	045 130 073 Q	0 986 441 555	057 130 851 BX	0 986 437 416
038 130 073 BK	0 414 720 306	038 130 079 RX	0 986 441 575	045 130 073 R	0 414 720 203	057 130 851 CX	0 986 437 418
038 130 073 BK	0 986 441 567	038 130 079 SX	0 986 441 560	045 130 073 S	0 414 720 207	057 130 851 DX	0 986 437 316
038 130 073 BL	0 414 720 307	038 130 079 TX	0 986 441 568	045 130 073 T	0 414 720 085	057 130 851 X	0 986 437 344
038 130 073 BL	0 986 441 568	038 130 079 X	0 986 441 553	045 130 073 T	0 986 441 551	059 130 105 A	0 986 444 067
038 130 073 BM	0 414 720 304	038 130 080 AX	0 986 441 567	045 130 079 AX	0 986 441 552	059 130 106	0 986 444 070
038 130 073 BM	0 414 720 308	038 130 080 BX	0 986 441 564	045 130 079 BX	0 986 441 555	059 130 106 A	0 470 506 046
038 130 073 BM	0 986 441 577	038 130 080 CX	0 986 441 571	045 130 079 X	0 986 441 551	059 130 106 A	0 986 444 074
038 130 073 BN	0 414 720 363	038 130 080 X	0 986 441 577	046 048 407	0 460 484 070	059 130 106 B	0 470 506 006
038 130 073 BN	0 986 441 568	038 130 107 B	0 460 404 972	046 048 410 8	0 460 484 108	059 130 106 B	0 986 444 068



059 130 106 BX	<b>0 986 444 068</b>
059 130 106 C	<b>0 986 444 070</b>
059 130 106 CX	<b>0 986 444 070</b>
059 130 106 D	<b>0 986 444 067</b>
059 130 106 DX	<b>0 986 444 067</b>
<hr/>	
059 130 106 E	<b>0 986 444 071</b>
059 130 106 EX	<b>0 986 444 071</b>
059 130 106 H	<b>0 986 444 073</b>
059 130 106 J	<b>0 986 444 072</b>
059 130 106 JX	<b>0 986 444 072</b>
<hr/>	
059 130 106 K	<b>0 986 444 083</b>
059 130 106 KX	<b>0 986 444 083</b>
059 130 106 L	<b>0 986 444 073</b>
059 130 106 LX	<b>0 986 444 073</b>
059 130 106 M	<b>0 986 444 084</b>
<hr/>	
059 130 108 A	<b>0 986 444 067</b>
059 130 108 AX	<b>0 986 444 067</b>
059 130 201	<b>0 432 133 835</b>
059 130 201 A	<b>0 432 133 824</b>
059 130 201 B	<b>0 432 133 817</b>
<hr/>	
059 130 201 D	<b>0 432 133 804</b>
059 130 201 F	<b>0 432 133 794</b>
059 130 201 G	<b>0 432 133 785</b>
059 130 202	<b>0 432 133 833</b>
059 130 202 B	<b>0 432 133 822</b>
<hr/>	
059 130 202 C	<b>0 432 133 815</b>
059 130 202 E	<b>0 432 133 802</b>
059 130 202 F	<b>0 432 133 792</b>
059 130 202 G	<b>0 432 133 783</b>
059 130 277 AA	<b>0 445 115 034</b>
<hr/>	
059 130 277 AB	<b>0 445 115 036</b>
059 130 277 AC	<b>0 445 115 038</b>
059 130 277 AC	<b>0 986 435 353</b>
059 130 277 AC	<b>0 986 435 388</b>
059 130 277 AH	<b>0 986 435 358</b>
<hr/>	
059 130 277 AJ	<b>0 445 115 053</b>
059 130 277 AJ	<b>0 986 435 353</b>
059 130 277 AJ	<b>0 986 435 388</b>
059 130 277 AM	<b>0 445 117 004</b>
059 130 277 AP	<b>0 445 116 007</b>
<hr/>	
059 130 277 AR	<b>0 445 116 014</b>
059 130 277 AR	<b>0 986 435 357</b>
059 130 277 B	<b>0 445 115 003</b>
059 130 277 BA	<b>0 445 115 082</b>
059 130 277 BB	<b>0 445 115 080</b>
<hr/>	
059 130 277 BD	<b>0 445 115 078</b>
059 130 277 BD	<b>0 986 435 358</b>
059 130 277 BE	<b>0 445 116 022</b>
059 130 277 BE	<b>0 986 435 357</b>
059 130 277 CC	<b>0 445 116 039</b>
<hr/>	
059 130 277 CD	<b>0 445 117 021</b>
059 130 277 CJ	<b>0 445 116 022</b>
059 130 277 CK	<b>0 445 117 028</b>
059 130 277 M	<b>0 445 115 018</b>
059 130 277 M	<b>0 986 435 353</b>
<hr/>	
059 130 277 M	<b>0 986 435 388</b>
059 130 277 Q	<b>0 445 115 003</b>
059 130 755 AB	<b>0 445 010 659</b>
059 130 755 AG	<b>0 445 010 654</b>
059 130 755 AH	<b>0 445 010 659</b>
<hr/>	
059 130 755 AL	<b>0 445 010 654</b>
059 130 755 BB	<b>0 445 010 659</b>
059 130 755 BC	<b>0 445 010 654</b>
059 130 755 BE	<b>0 445 010 656</b>
059 130 755 BF	<b>0 445 010 657</b>
<hr/>	
059 130 755 BG	<b>0 445 010 658</b>
059 130 755 BK	<b>0 445 010 673</b>
059 130 755 BL	<b>0 445 010 673</b>
059 130 755 BN	<b>0 445 010 327</b>
059 130 755 H	<b>0 445 010 133</b>
<hr/>	
059 130 755 J	<b>0 445 010 343</b>
059 130 755 L	<b>0 445 010 133</b>
059 130 755 N	<b>0 445 010 343</b>
059 130 755 N	<b>0 986 437 348</b>
059 130 755 S	<b>0 445 010 331</b>
<hr/>	
059 130 755 T	<b>0 445 010 659</b>
059 130 851 AX	<b>0 986 437 348</b>
059 130 851 X	<b>0 986 437 093</b>
062 130 107	<b>0 460 424 138</b>
062 130 107	<b>0 986 440 228</b>
<hr/>	
062 130 107 A	<b>0 460 424 222</b>
062 130 201	<b>0 445 110 081</b>
062 130 201 A	<b>0 445 110 125</b>
062 130 205	<b>0 432 193 731</b>
062 130 755	<b>0 445 010 044</b>
<hr/>	
068 130 081 F	<b>0 986 440 125</b>
068 130 081 FX	<b>0 986 440 125</b>
068 130 107 H	<b>0 460 494 039</b>
068 130 107 H	<b>0 986 440 113</b>
068 130 107 HX	<b>0 986 440 113</b>
<hr/>	
068 130 107 T	<b>0 986 440 123</b>
068 130 107 TX	<b>0 986 440 123</b>
068 130 108 G	<b>0 460 494 108</b>
068 130 108 G	<b>0 986 440 246</b>
068 130 108 GX	<b>0 986 440 246</b>
<hr/>	
068 130 108 M	<b>0 460 494 039</b>
068 130 108 M	<b>0 986 440 113</b>
068 130 109 R	<b>0 460 484 108</b>
068 130 109 R1	<b>0 460 484 108</b>
068 130 109 6	<b>0 460 494 165</b>
<hr/>	
068 130 110 A	<b>0 460 484 141</b>
068 130 110 B	<b>0 986 440 135</b>
068 130 110 BX	<b>0 986 440 135</b>
068 130 110 Q	<b>0 986 440 135</b>
068 130 110 QX	<b>0 986 440 135</b>
<hr/>	
068 130 201 B	<b>0 986 430 080</b>
068 130 201 BX	<b>0 986 430 080</b>
068 130 201 C	<b>0 432 217 077</b>
068 130 201 E	<b>0 432 217 084</b>
068 130 201 E	<b>0 986 430 081</b>
<hr/>	
068 130 201 EX	<b>0 986 430 081</b>
068 130 201 J	<b>0 986 430 089</b>
068 130 201 JX	<b>0 986 430 089</b>
068 130 201 K	<b>0 986 430 089</b>
068 130 201 KX	<b>0 986 430 089</b>
<hr/>	
068 130 201 N	<b>0 432 217 164</b>
068 130 201 R	<b>0 986 430 190</b>
068 130 201 RX	<b>0 986 430 190</b>
068 130 202	<b>0 432 217 207</b>
068 130 202	<b>0 986 430 189</b>
<hr/>	
068 130 202 A	<b>0 432 217 210</b>
068 130 202 A	<b>0 986 430 234</b>
068 130 202 D	<b>0 986 430 235</b>
068 130 202 DX	<b>0 986 430 235</b>
068 130 202 E	<b>0 986 430 225</b>
<hr/>	
068 130 202 EX	<b>0 986 430 225</b>
068 130 202 F	<b>0 432 217 240</b>
068 130 202 F	<b>0 986 430 187</b>
068 130 202 FX	<b>0 432 217 240</b>
068 130 202 FX	<b>0 986 430 187</b>
<hr/>	
068 130 202 G	<b>0 986 430 188</b>
068 130 202 GX	<b>0 986 430 188</b>
068 130 202 X	<b>0 986 430 189</b>
07Z 130 073 D	<b>0 414 720 260</b>
07Z 130 073 F	<b>0 414 720 260</b>
<hr/>	
07Z 130 073 F	<b>0 986 441 561</b>
07Z 130 073 FX	<b>0 414 720 260</b>
07Z 130 073 FX	<b>0 986 441 561</b>
07Z 130 073 G	<b>0 414 720 217</b>
07Z 130 073 H	<b>0 414 720 270</b>
<hr/>	
07Z 130 073 H	<b>0 986 441 565</b>
07Z 130 073 HX	<b>0 414 720 270</b>
07Z 130 073 HX	<b>0 986 441 565</b>
07Z 130 073 K	<b>0 414 720 275</b>
07Z 130 073 K	<b>0 986 441 563</b>
<hr/>	
07Z 130 073 KX	<b>0 414 720 275</b>
07Z 130 073 KX	<b>0 986 441 563</b>
07Z 130 073 N	<b>0 414 720 359</b>
07Z 130 073 N	<b>0 986 441 578</b>
07Z 130 073 NX	<b>0 986 441 578</b>
<hr/>	
07Z 130 073 S	<b>0 414 720 301</b>
07Z 130 073 S	<b>0 414 720 305</b>
07Z 130 073 S	<b>0 986 441 576</b>
07Z 130 073 T	<b>0 414 720 361</b>
07Z 130 073 T	<b>0 986 441 576</b>
<hr/>	
07Z 130 073 TX	<b>0 986 441 576</b>
070 130 073 K	<b>0 414 720 211</b>
070 130 073 N	<b>0 414 720 278</b>
070 130 073 N	<b>0 986 441 573</b>
070 130 073 NX	<b>0 986 441 573</b>
<hr/>	
070 130 073 R	<b>0 414 720 360</b>
070 130 073 R	<b>0 986 441 579</b>
070 130 073 RX	<b>0 986 441 579</b>
074 130 107 E	<b>0 460 485 017</b>
074 130 107 E	<b>0 986 440 242</b>
<hr/>	
074 130 107 EX	<b>0 986 440 242</b>
074 130 107 N	<b>0 986 440 565</b>
074 130 107 NX	<b>0 986 440 565</b>
074 130 108 G	<b>0 460 485 017</b>
074 130 108 G	<b>0 986 440 242</b>
<hr/>	
074 130 108 GX	<b>0 986 440 242</b>
074 130 108 L	<b>0 986 440 256</b>
074 130 108 M	<b>0 460 485 017</b>
074 130 108 M	<b>0 986 440 252</b>
074 130 108 Q	<b>0 986 440 256</b>
<hr/>	
074 130 108 S	<b>0 986 440 252</b>
074 130 108 T	<b>0 986 440 256</b>
074 130 109 B	<b>0 460 415 983</b>
074 130 109 B	<b>0 986 440 562</b>
074 130 109 BX	<b>0 986 440 562</b>
<hr/>	
074 130 109 C	<b>0 986 440 254</b>
074 130 109 CX	<b>0 986 440 254</b>
074 130 109 G	<b>0 986 440 243</b>
074 130 109 H	<b>0 460 415 990</b>
074 130 109 H	<b>0 986 440 564</b>
<hr/>	
074 130 109 HX	<b>0 986 440 564</b>
074 130 109 K	<b>0 986 440 243</b>
074 130 109 N	<b>0 986 440 256</b>
074 130 109 NX	<b>0 986 440 256</b>
074 130 109 Q	<b>0 460 415 987</b>
<hr/>	
074 130 109 Q	<b>0 986 440 569</b>
074 130 109 QX	<b>0 986 440 569</b>
074 130 109 R	<b>0 986 440 571</b>
074 130 109 RX	<b>0 986 440 571</b>
074 130 109 S	<b>0 986 440 244</b>
<hr/>	
074 130 109 T	<b>0 986 440 253</b>
074 130 110	<b>0 460 485 036</b>
074 130 110 A	<b>0 460 415 990</b>
074 130 110 A	<b>0 986 440 564</b>
074 130 110 AX	<b>0 986 440 564</b>
<hr/>	
074 130 110 F	<b>0 986 440 244</b>
074 130 110 G	<b>0 460 485 036</b>
074 130 110 H	<b>0 986 440 253</b>
074 130 110 J	<b>0 986 440 243</b>
074 130 110 K	<b>0 986 440 565</b>
<hr/>	
074 130 110 KX	<b>0 986 440 565</b>
074 130 110 M	<b>0 460 415 990</b>
074 130 110 M	<b>0 986 440 564</b>
074 130 110 MX	<b>0 986 440 564</b>
074 130 110 N	<b>0 986 440 562</b>
<hr/>	
074 130 110 NX	<b>0 986 440 562</b>
074 130 115 B	<b>0 460 415 983</b>
074 130 115 B	<b>0 986 440 562</b>
074 130 115 BX	<b>0 986 440 562</b>
074 130 201 C	<b>0 432 193 823</b>
<hr/>	
074 130 201 G	<b>0 432 193 716</b>
074 130 201 J	<b>0 432 193 662</b>
074 130 201 K	<b>0 432 193 669</b>
074 130 201 Q	<b>0 432 193 615</b>
074 130 201 T	<b>0 432 193 552</b>



## ◀VW

074 130 202 A	<b>0 432 193 821</b>
074 130 202 B	<b>0 432 193 771</b>
074 130 202 M	<b>0 432 193 608</b>
074 130 202 P	<b>0 432 193 621</b>
074 130 202 Q	<b>0 432 193 619</b>

074 130 202 R	<b>0 432 193 608</b>
074 130 202 S	<b>0 432 193 617</b>
074 130 203 A	<b>0 432 193 613</b>
074 130 203 B	<b>0 432 193 510</b>
074 130 204 C	<b>0 432 193 550</b>

074 130 204 D	<b>0 432 193 508</b>
075 130 107 D	<b>0 986 440 016</b>
075 130 107 DX	<b>0 986 440 016</b>
075 130 107 E	<b>0 986 440 017</b>
075 130 107 EX	<b>0 986 440 017</b>

075 130 107 L	<b>0 460 406 073</b>
075 130 107 L	<b>0 986 440 235</b>
075 130 107 LX	<b>0 986 440 235</b>
075 130 107 Q	<b>0 460 406 075</b>
075 130 107 Q	<b>0 986 440 236</b>

075 130 107 QX	<b>0 986 440 236</b>
075 130 108 A	<b>0 986 440 235</b>
076 130 107 G	<b>0 460 406 039</b>
076 130 107 G	<b>0 986 440 233</b>
076 130 107 GX	<b>0 986 440 233</b>

076 130 107 H	<b>0 460 406 040</b>
076 130 107 H	<b>0 986 440 234</b>
076 130 107 HX	<b>0 986 440 234</b>
076 130 277	<b>0 445 115 028</b>
076 130 277	<b>0 986 435 352</b>

2P0 130 105	<b>0 445 010 294</b>
2P0 130 201	<b>0 445 110 231</b>
2RD 130 105	<b>0 460 424 102</b>
2RD 130 105 A	<b>0 460 424 128</b>
2RD 130 201	<b>9 430 082 752</b>

2RD 130 201 A	<b>9 430 082 767</b>
2RE 130 105 A	<b>0 460 424 131</b>
2RE 130 105 B	<b>0 460 424 194</b>
2RE 130 201	<b>9 430 082 769</b>
2RH 130 105 B	<b>0 460 426 250</b>

2RK 130 201 A	<b>9 430 082 762</b>
2RL 130 105 A	<b>0 460 426 251</b>
2RL 130 201 B	<b>9 430 082 747</b>
2R0 130 105	<b>0 445 020 007</b>
2R0 130 105 B	<b>0 445 020 033</b>

2R0 130 105 C	<b>0 460 424 369</b>
2R0 130 201 A	<b>0 445 120 007</b>
2R0 130 201 A	<b>0 986 435 508</b>
2R0 130 201 B	<b>0 445 120 043</b>
2R0 198 133	<b>0 445 120 212</b>

2S0 129 405	<b>F 000 439 018</b>
2S0 130 081	<b>0 460 426 342</b>
2S0130105	<b>0 460 424 369</b>
2 S0 130 107	<b>0 460 426 324</b>
2S2 130 200	<b>0 445 120 077</b>

2TA 130 105 A	<b>0 460 424 115</b>
2TA 130 105 AX	<b>0 460 424 115</b>
2TA 130 201	<b>9 430 082 759</b>
2TB 130 201	<b>F 000 439 013</b>
2TG 130 201	<b>F 000 439 004</b>

2TJ 130 201	<b>F 000 439 005</b>
2 TO 130 201	<b>0 432 133 837</b>
2T0 130 201 A	<b>0 432 191 629</b>
2T0 130 201 B	<b>F 000 439 019</b>
2T0 130 201 C	<b>F 000 439 022</b>

2T0 130 201 D	<b>F 000 439 029</b>
2T2 130 201	<b>0 445 120 089</b>
2T2 130 201 A	<b>0 445 120 094</b>
2T2 130 201 D	<b>0 445 120 120</b>
2T2 198 133	<b>0 445 120 140</b>

2UV 130 105	<b>0 460 424 103</b>
2U0 130 201 A	<b>F 000 439 015</b>
2U0 130 201 B	<b>0 432 191 592</b>
2VC 130 105	<b>0 460 424 210</b>
2VC 130 105 A	<b>0 460 424 211</b>

415 086	<b>9 430 082 296</b>
---------	----------------------

**XINCHEN**

DK4A-1112010	<b>0 445 110 317</b>
--------------	----------------------

**YANGCHAI (YANGZHOU DIESEL ENG)**

2014355	<b>0 445 110 345</b>
---------	----------------------

**YUCHAI**

FC700-1112100-A38	<b>0 445 110 356</b>
G1000-1112100-A38	<b>0 445 120 225</b>
G2100-1112100-A38	<b>0 445 120 083</b>

J0100-1112100-A38	<b>0 445 120 165</b>
J6A00-1112100-A38	<b>0 445 120 292</b>
M6000 1112100 A38	<b>0 445 120 160</b>

**YUNMA**

15 06 2057F	<b>0 986 435 153</b>
-------------	----------------------

**ZEXEL**

NP-VE4/10F2200R365-1	<b>9 460 620 007</b>
NP-VE4/10F2200R365 2	<b>9 460 620 011</b>
NP-VE4/11F1800RNP110	<b>9 460 610 609</b>

NP-VE4/11F1800RNP999	<b>9 460 610 656</b>
NP-VE 4/8 F 2600 R	<b>9 460 620 008</b>
NP-VE4/8F2600R284	<b>9 460 620 001</b>
NP-VE4/9F2500R305	<b>9 460 620 002</b>
NP-VE4/9F2500R305 2	<b>9 460 620 009</b>

NP-VE4/9F2500R341	<b>9 460 620 003</b>
VE 4/10F2200R365 3	<b>9 460 620 017</b>
VE 4/10F2250R 554-1	<b>9 460 620 016</b>
VE 4/8F2600R284-3	<b>9 460 620 014</b>
VE 4/9 F2500 R 305 3	<b>9 460 620 015</b>

0445020083	<b>0 445 020 083</b>
0445120126	<b>0 445 120 126</b>
104544-2201	<b>9 460 610 525</b>
104640-0002	<b>9 460 610 621</b>
104700-0512	<b>9 460 613 193</b>

104700-3001	<b>9 460 611 401</b>
104701-2008	<b>9 460 611 581</b>
104701-2032	<b>9 460 613 261</b>
104701-3004	<b>9 460 613 861</b>
104701-3032	<b>9 460 613 827</b>

104701-3041	<b>9 460 611 404</b>
104721-2005	<b>9 460 611 586</b>
104740-0002	<b>9 460 610 621</b>
104740-0105	<b>9 460 611 759</b>
104740-0156	<b>9 460 610 726</b>

104740-0366	<b>9 460 610 712</b>
104740-0423	<b>9 460 610 549</b>
104740-0454	<b>9 460 611 277</b>
104740-0517	<b>9 460 610 690</b>
104740-0642	<b>9 460 611 536</b>

104740-1933	<b>9 460 620 007</b>
104740-1943	<b>9 460 620 010</b>
104740-2051	<b>9 460 610 125</b>
104740-2206	<b>9 460 610 551</b>
104740-2214	<b>9 460 610 515</b>

104740-2216	<b>9 460 610 552</b>
104740-2227	<b>9 460 610 553</b>
104740-2285	<b>9 460 610 597</b>
104740-2600	<b>9 460 610 703</b>
104740-2714	<b>9 460 610 791</b>

104740-2740	<b>9 460 610 956</b>
104740-3180	<b>9 460 610 611</b>
104740-3360	<b>9 460 610 003</b>
104740-3490	<b>9 460 610 612</b>
104740-3900	<b>9 460 610 580</b>

104740-4370	<b>9 460 610 008</b>
104740-4400	<b>9 460 610 010</b>
104740-4560	<b>9 460 610 251</b>
104740-4621	<b>9 460 610 254</b>
104740-4641	<b>9 460 610 280</b>

104740-4734	<b>9 460 610 412</b>
104740-4760	<b>9 460 610 220</b>
104740-4770	<b>9 460 610 140</b>
104740 6001	<b>9 460 620 011</b>
104740 6002	<b>9 460 620 011</b>

104740-6040	<b>9 460 620 012</b>
104740-6050	<b>9 460 620 013</b>
104740-6060	<b>9 460 620 016</b>
104740 6070	<b>9 460 620 017</b>
104740 6071	<b>9 460 620 017</b>

104740-6092	<b>9 460 620 019</b>
104740-6110	<b>9 460 620 020</b>
104740-6140	<b>9 460 620 023</b>
104740-6142	<b>9 460 620 023</b>
104740-6143	<b>9 460 613 973</b>

104740-7114	<b>9 460 610 561</b>
104740-7351	<b>9 460 614 311</b>
104740-7420	<b>9 460 611 543</b>
104740-7670	<b>9 460 610 588</b>
104740-7680	<b>9 460 610 536</b>

104740-8012	<b>9 460 610 625</b>
104740-8144	<b>9 460 611 591</b>
104740-8182	<b>9 460 610 523</b>
104740-8240	<b>9 460 610 508</b>
104740-8250	<b>9 460 610 528</b>

104740-8311	<b>9 460 610 623</b>
104740-8730	<b>9 460 610 640</b>
104740-8750	<b>9 460 610 643</b>
104740-8820	<b>9 460 610 693</b>
104740-8910	<b>9 460 610 694</b>

104740-8960	<b>9 460 610 663</b>
104740-9533	<b>9 460 610 634</b>
104740-9541	<b>9 460 610 416</b>
104740-9551	<b>9 460 610 732</b>
104740-9573	<b>9 460 610 538</b>

104740-9633	<b>9 460 610 314</b>
104740-9870	<b>9 460 610 388</b>
104741-1064	<b>9 460 610 409</b>
104741-1084	<b>9 460 610 323</b>
104741-1181	<b>9 460 610 324</b>

104741-1202	<b>9 460 610 594</b>
104741-1272	<b>9 460 610 319</b>
104741-1691	<b>9 460 610 518</b>
104741-1744	<b>9 460 610 691</b>
104741-3213	<b>9 460 610 808</b>

104741-3250	<b>9 460 610 776</b>
104741-3690	<b>9 460 613 225</b>
104741-3750	<b>9 460 613 439</b>
104741-3822	<b>9 460 613 822</b>
104741-3831	<b>9 460 613 834</b>

104741-3842	<b>9 460 613 835</b>
104741-3882	<b>9 460 614 418</b>
104741-4122	<b>9 460 611 937</b>
104741-4231	<b>9 460 610 633</b>
104741-4360	<b>9 460 611 179</b>

104741-4413	<b>9 460 611 356</b>
104741-5240	<b>9 460 610 453</b>
104741-5472	<b>9 460 610 656</b>
104741-5640	<b>9 460 612 208</b>
104741-5680	<b>9 460 611 532</b>



104741-5862	<b>9 460 610 963</b>	104746-6510	<b>9 460 613 187</b>	105071-0681	<b>0 986 433 011</b>	105101-4570	<b>9 430 611 278</b>
104741-5891	<b>9 460 610 596</b>	104746-6990	<b>9 460 613 479</b>	105071-1241	<b>9 430 615 048</b>	105101-4760	<b>9 430 611 289</b>
104741-5901	<b>9 460 610 544</b>	104748-0051	<b>9 460 610 216</b>	105071-1270	<b>0 986 433 010</b>	105101-4891	<b>9 430 611 301</b>
104741-5990	<b>9 460 610 609</b>	104748-0134	<b>9 460 610 188</b>	105071-1361	<b>0 986 433 007</b>	105101-5171	<b>9 430 611 326</b>
104741-6131	<b>9 460 610 386</b>	104748-0152	<b>9 460 610 144</b>	105071-1361	<b>0 986 433 012</b>	105101-5320	<b>9 430 611 341</b>
104741-6132	<b>9 460 610 744</b>	104748-0226	<b>9 460 610 667</b>	105071-1361	<b>0 986 433 013</b>	105101-5490	<b>9 430 610 153</b>
104741-6212	<b>9 460 611 807</b>	104748-0232	<b>9 460 610 613</b>	105078-0050	<b>0 986 433 009</b>	105101-5620	<b>9 430 611 370</b>
104741-6390	<b>9 460 613 371</b>	104748-0344	<b>9 460 610 311</b>	105078-0150	<b>9 430 610 097</b>	105101-5630	<b>9 430 611 371</b>
104741-6410	<b>9 460 613 423</b>	104748-1704	<b>9 460 610 607</b>	105088-1061	<b>0 986 433 005</b>	105101-5741	<b>9 430 611 381</b>
104741-6597	<b>9 460 611 431</b>	104748-1722	<b>9 460 620 001</b>	105088-1090	<b>0 986 433 002</b>	105101-5790	<b>9 430 611 387</b>
104741-6631	<b>9 460 610 377</b>	104748-1724	<b>9 460 620 001</b>	105088-1090	<b>0 986 433 004</b>	105101-5800	<b>9 430 611 388</b>
104741-6690	<b>9 460 610 711</b>	104748-1732	<b>9 460 610 620</b>	105088-1090	<b>0 986 433 005</b>	105101-5880	<b>9 430 611 396</b>
104741-6732	<b>9 460 611 811</b>	104748-1820	<b>9 460 620 005</b>	105088-1120	<b>0 986 433 000</b>	105101-6111	<b>9 430 611 427</b>
104741-6850	<b>9 460 610 413</b>	104748-1841	<b>9 460 620 008</b>	105088-1130	<b>0 986 433 001</b>	105101-6420	<b>9 430 611 464</b>
104741-6890	<b>9 460 610 646</b>	104748-1844	<b>9 460 620 008</b>	105100-4372	<b>9 430 610 174</b>	105101-6510	<b>9 430 611 475</b>
104741-8161	<b>F 01G 09W OGE</b>	104748-1850	<b>9 460 620 014</b>	105100-4470	<b>9 430 610 778</b>	105101-6840	<b>9 430 611 518</b>
104741-8190	<b>F 01G 09W OEL</b>	104748-2100	<b>9 460 610 483</b>	105100-4582	<b>9 430 610 791</b>	105101-6850	<b>9 430 611 519</b>
104742-1270	<b>9 460 610 654</b>	104748-2332	<b>9 460 610 485</b>	105100-4762	<b>9 430 613 767</b>	105101-6880	<b>9 430 612 985</b>
104742-1471	<b>9 460 611 813</b>	104748-2370	<b>9 460 610 066</b>	105100-4771	<b>9 430 610 819</b>	105101-6970	<b>9 430 611 529</b>
104742-2005	<b>9 460 611 364</b>	104748-2581	<b>9 460 610 763</b>	105100-4902	<b>9 430 610 838</b>	105101-7040	<b>9 430 611 536</b>
104742-7044	<b>9 460 611 109</b>	104748-8473	<b>9 460 613 400</b>	105100-4950	<b>9 430 610 844</b>	105101-7151	<b>9 430 611 553</b>
104745-3150	<b>9 460 610 816</b>	104749-0344	<b>9 460 610 309</b>	105100-4960	<b>9 430 610 845</b>	105101-7431	<b>9 430 611 595</b>
104745-3153	<b>9 460 614 156</b>	104749-1020	<b>9 460 610 015</b>	105100-5031	<b>9 430 612 972</b>	105101-7600	<b>9 430 611 621</b>
104745-3290	<b>9 460 610 908</b>	104749-1131	<b>9 460 610 221</b>	105100-5351	<b>9 430 610 901</b>	105101-7802	<b>9 430 611 638</b>
104745-3300	<b>9 460 610 909</b>	104749-1491	<b>9 460 610 153</b>	105100-5430	<b>9 430 610 097</b>	105101-7882	<b>9 430 611 647</b>
104745-3310	<b>9 460 610 671</b>	104749-2033	<b>9 460 611 181</b>	105100-5700	<b>9 430 610 940</b>	105101-8422	<b>9 430 612 737</b>
104745-3503	<b>9 460 610 724</b>	104749-2144	<b>9 460 610 567</b>	105100-5721	<b>9 430 613 826</b>	105101-8460	<b>9 430 611 705</b>
104745-3641	<b>9 460 611 605</b>	104749-2230	<b>9 460 610 195</b>	105100-5762	<b>9 430 610 945</b>	105104-3090	<b>F 01G 09X O6Y</b>
104745-4033	<b>9 460 610 702</b>	104749-2262	<b>9 460 610 380</b>	105100-5830	<b>9 430 610 955</b>	105110-4320	<b>9 430 610 081</b>
104745-4124	<b>9 460 610 674</b>	104749-2552	<b>9 460 610 635</b>	105100-5840	<b>9 430 610 083</b>	105110-4370	<b>9 430 611 795</b>
104745-4291	<b>9 460 610 734</b>	104749-3010	<b>9 460 610 079</b>	105100-5870	<b>9 430 610 080</b>	105110-4564	<b>9 430 613 467</b>
104745-8470	<b>9 460 611 369</b>	104749-5090	<b>9 460 620 003</b>	105100-5990	<b>9 430 610 971</b>	105110-4620	<b>9 430 611 831</b>
104745-8473	<b>9 400 613 400</b>	104749-5091	<b>9 460 620 003</b>	105100-6020	<b>9 430 610 974</b>	105110-4702	<b>9 430 613 993</b>
104745-8473	<b>9 460 613 400</b>	104749-5271	<b>9 460 610 933</b>	105100-6051	<b>9 430 610 977</b>	105110-7053	<b>9 430 612 776</b>
104745-8474	<b>9 460 614 159</b>	104749-5354	<b>9 460 620 009</b>	105100-6141	<b>9 430 610 986</b>	105110-7062	<b>9 430 612 785</b>
104745-8691	<b>9 460 613 234</b>	104749-5420	<b>9 460 620 015</b>	105100-6180	<b>9 430 610 990</b>	105110-7183	<b>9 430 612 792</b>
104745-8810	<b>9 460 613 248</b>	104749-5421	<b>9 460 620 015</b>	105100-6210	<b>9 430 610 106</b>	105110-7341	<b>9 430 611 917</b>
104745-8811	<b>9 460 613 248</b>	104749-5481	<b>9 460 614 107</b>	105100-6220	<b>9 430 610 992</b>	105110-7370	<b>9 430 611 921</b>
104745-9412	<b>9 460 611 021</b>	104749-6021	<b>9 460 610 181</b>	105100-6241	<b>9 430 610 996</b>	105110-7591	<b>9 430 612 936</b>
104746-1091	<b>9 460 610 626</b>	104749-6913	<b>9 460 620 002</b>	105100-6260	<b>9 430 610 997</b>	105110-7630	<b>9 430 611 945</b>
104746-1230	<b>9 460 610 828</b>	104749-6916	<b>9 460 620 002</b>	105100-6391	<b>9 430 612 959</b>	105110-7820	<b>9 430 611 974</b>
104746-1311	<b>9 460 610 708</b>	104760-4112	<b>9 460 612 000</b>	105100-6830	<b>9 430 611 044</b>	105110-8112	<b>9 430 613 505</b>
104746-1391	<b>9 460 610 756</b>	104760-4122	<b>9 460 611 660</b>	105100-6970	<b>9 430 611 060</b>	105110-8121	<b>9 430 613 360</b>
104746-1820	<b>9 460 611 262</b>	104760-4132	<b>9 460 611 661</b>	105100-6991	<b>9 430 611 063</b>	105110-8122	<b>9 430 613 825</b>
104746-1841	<b>9 460 613 144</b>	104760-4630	<b>9 460 610 965</b>	105100-7003	<b>9 430 611 065</b>	105110-8172	<b>9 430 613 508</b>
104746-1851	<b>9 460 611 152</b>	104761-0046	<b>9 460 612 054</b>	105100-7230	<b>9 430 611 092</b>	105110-8181	<b>9 430 613 509</b>
104746-1871	<b>9 460 610 952</b>	104761-4022	<b>9 460 610 321</b>	105100-7240	<b>9 430 611 093</b>	105110-8341	<b>9 430 613 759</b>
104746-1890	<b>9 460 611 099</b>	104761-4072	<b>9 460 610 767</b>	105100-7270	<b>9 430 611 097</b>	105111-1231	<b>9 430 610 014</b>
104746-1900	<b>9 460 611 100</b>	104769-2074	<b>9 460 610 497</b>	105100-7350	<b>9 430 611 108</b>	105111-1281	<b>9 430 610 027</b>
104746-1930	<b>9 460 611 710</b>	104769-2154	<b>9 460 610 572</b>	105100-7510	<b>9 430 611 126</b>	105111-4023	<b>9 430 613 651</b>
104746-1942	<b>9 460 611 449</b>	104769-2165	<b>9 460 610 556</b>	105100-7550	<b>9 430 611 130</b>	105111-4040	<b>9 430 612 035</b>
104746-1950	<b>9 460 611 840</b>	104769-2176	<b>9 460 610 573</b>	105100-7670	<b>9 430 611 141</b>	105111-4060	<b>9 430 610 110</b>
104746-5170	<b>9 460 613 906</b>	104780-4800	<b>9 460 611 503</b>	105100-7810	<b>9 430 611 157</b>	105111-4160	<b>9 430 612 056</b>
104746-6340	<b>9 460 611 452</b>	105031-4520	<b>9 430 615 046</b>	105100-7890	<b>9 430 611 167</b>	105111-4530	<b>9 430 612 113</b>
104746-6350	<b>9 460 611 360</b>	105071-0681	<b>0 986 433 006</b>	105100-7961	<b>9 430 613 773</b>	105111-4680	<b>9 430 612 126</b>



◀ ZEXEL

105111-4870	<b>9 430 612 143</b>	105118-7420	<b>9 430 610 203</b>	105141-2440	<b>9 430 610 055</b>	105148-8003	<b>9 443 611 769</b>
105111-5250	<b>F 01G 09X 06P</b>	105118-7542	<b>9 430 613 635</b>	105141-2471	<b>9 430 610 036</b>	105148-8010	<b>9 443 610 385</b>
105113-3800	<b>F 01G 09X 074</b>	105118-7560	<b>9 430 613 108</b>	105141-2512	<b>0 986 433 006</b>	105151-1480	<b>9 430 610 456</b>
105113-3860	<b>F 01G 09X 073</b>	105118-7621	<b>9 430 613 869</b>	105141-2512	<b>9 430 610 033</b>	105151-1530	<b>9 430 610 459</b>
105115-3064	<b>F 01G 09X 05Y</b>	105118-7770	<b>9 430 610 236</b>	105141-2520	<b>9 430 610 358</b>	105151-1580	<b>9 430 610 032</b>
105115-3120	<b>F 01G 09X 06W</b>	105118-7833	<b>9 430 613 745</b>	105141-2630	<b>9 430 610 054</b>	105158-2061	<b>0 986 433 005</b>
105118-4080	<b>9 430 612 387</b>	105118-7834	<b>9 430 613 989</b>	105141-2660	<b>0 986 433 011</b>	105158-2072	<b>9 430 610 066</b>
105118-4110	<b>9 430 612 390</b>	105118-7910	<b>9 430 612 757</b>	105141-2660	<b>9 430 610 037</b>	105158-2081	<b>0 986 433 004</b>
105118-4201	<b>9 430 612 399</b>	105118-7911	<b>9 430 613 608</b>	105141-2821	<b>0 986 433 013</b>	105158-2132	<b>9 430 613 199</b>
105118-4212	<b>9 430 610 126</b>	105118-7912	<b>F 01G 09X 003</b>	105141-2821	<b>9 430 610 098</b>	105158-2160	<b>0 986 433 004</b>
105118-4223	<b>9 430 612 402</b>	105118-7931	<b>9 430 613 206</b>	105141-2870	<b>9 430 610 385</b>	105158-2161	<b>9 430 610 117</b>
105118-4224	<b>9 430 613 671</b>	105118-7981	<b>9 430 613 871</b>	105141-2880	<b>9 430 610 386</b>	105158-2162	<b>0 986 433 004</b>
105118-4252	<b>9 430 612 409</b>	105118-7982	<b>F 01G 09X 03R</b>	105141-2900	<b>9 430 610 388</b>	105158-2162	<b>9 430 610 136</b>
105118-4271	<b>9 430 612 412</b>	105118-8021	<b>9 430 613 533</b>	105141-2911	<b>9 430 610 390</b>	105158-2171	<b>0 986 433 005</b>
105118-4321	<b>9 430 612 418</b>	105118-8022	<b>9 430 613 739</b>	105141-2950	<b>0 986 433 008</b>	105158-2171	<b>9 430 610 137</b>
105118-4403	<b>9 430 612 431</b>	105118-8060	<b>9 430 613 217</b>	105141-2950	<b>9 430 610 105</b>	105158-2224	<b>0 986 433 002</b>
105118-4431	<b>9 430 612 436</b>	105118-8080	<b>9 430 613 411</b>	105141-2971	<b>9 430 612 748</b>	105158-2225	<b>0 986 433 002</b>
105118-4461	<b>9 430 610 102</b>	105118-8133	<b>9 430 613 960</b>	105141-8033	<b>9 443 611 765</b>	105158-2225	<b>9 430 610 128</b>
105118-4570	<b>9 430 612 453</b>	105118-8151	<b>9 430 613 724</b>	105141-8040	<b>9 443 611 288</b>	105158-2234	<b>9 430 610 129</b>
105118-4620	<b>9 430 612 459</b>	105118-8180	<b>9 430 613 450</b>	105141-8051	<b>9 443 611 767</b>	105158-2241	<b>9 430 610 148</b>
105118-4724	<b>9 430 612 478</b>	105118-8212	<b>9 430 613 961</b>	105141-8080	<b>9 443 610 422</b>	105158-2262	<b>0 986 433 000</b>
105118-4862	<b>9 430 612 492</b>	105118-8220	<b>9 430 613 873</b>	105148-1002	<b>9 430 610 397</b>	105158-2263	<b>0 986 433 000</b>
105118-5031	<b>9 430 612 516</b>	105118-8280	<b>9 430 613 778</b>	105148-1010	<b>9 430 610 009</b>	105158-2263	<b>9 430 610 161</b>
105118-5131	<b>9 430 612 531</b>	105118-8291	<b>9 430 613 974</b>	105148-1012	<b>9 430 610 399</b>	105158-2282	<b>9 430 610 494</b>
105118-5210	<b>9 430 612 541</b>	105118-8303	<b>9 430 613 962</b>	105148-1074	<b>9 430 610 403</b>	105158-2300	<b>0 986 433 001</b>
105118-5225	<b>9 430 612 545</b>	105118-8310	<b>9 430 613 876</b>	105148-1112	<b>9 430 610 407</b>	105158-2301	<b>0 986 433 001</b>
105118-5381	<b>9 430 612 563</b>	105118-8362	<b>9 430 613 968</b>	105148-1120	<b>9 430 610 048</b>	105158-2301	<b>9 430 610 140</b>
105118-5500	<b>9 430 612 573</b>	105118-8371	<b>9 430 613 921</b>	105148-1150	<b>0 986 433 009</b>	105158-2380	<b>9 430 610 505</b>
105118-5730	<b>9 430 612 601</b>	105118-8372	<b>9 430 613 969</b>	105148-1150	<b>9 430 610 065</b>	105158-5002	<b>F 01G 0V4 000</b>
105118-5750	<b>9 430 612 603</b>	105118-8381	<b>9 430 613 920</b>	105148-1151	<b>9 430 613 539</b>	105158-5080	<b>9 430 613 451</b>
105118-6051	<b>9 430 610 152</b>	105118-8390	<b>9 430 613 801</b>	105148-1170	<b>9 430 610 172</b>	105160-4041	<b>9 430 610 513</b>
105118-6230	<b>9 430 612 640</b>	105118-8391	<b>F 01G 09X 03S</b>	105148-1183	<b>9 430 610 157</b>	105160-4051	<b>9 430 610 514</b>
105118-6272	<b>9 430 613 596</b>	105119-4270	<b>F 01G 09X 06V</b>	105148-1221	<b>9 430 610 135</b>	105160-4061	<b>9 430 610 515</b>
105118-6400	<b>9 430 610 163</b>	105119-4350	<b>F 01G 09X 06X</b>	105148-1254	<b>9 430 610 141</b>	105160-4100	<b>9 430 610 520</b>
105118-6401	<b>9 430 613 689</b>	105140-1021	<b>9 430 610 109</b>	105148-1255	<b>9 430 613 817</b>	105160-4170	<b>9 430 610 525</b>
105118-6490	<b>9 430 612 668</b>	105140-1070	<b>0 986 433 007</b>	105148-1261	<b>9 430 610 125</b>	105160-4292	<b>9 430 610 536</b>
105118-6491	<b>9 430 613 688</b>	105140-1070	<b>9 430 610 132</b>	105148-1271	<b>9 430 610 416</b>	105160-4521	<b>9 430 610 554</b>
105118-6600	<b>9 430 612 681</b>	105140-1180	<b>9 430 610 294</b>	105148-1282	<b>9 430 610 154</b>	105160-4531	<b>9 430 610 556</b>
105118-6690	<b>9 430 610 184</b>	105140-1191	<b>9 430 610 165</b>	105148-1301	<b>9 430 610 420</b>	105171-1361	<b>0 986 433 008</b>
105118-6710	<b>9 430 612 692</b>	105140-1290	<b>9 430 610 297</b>	105148-1311	<b>9 430 610 179</b>	105195-5470	<b>9 430 610 695</b>
105118-6811	<b>9 430 613 697</b>	105140-1360	<b>9 430 613 243</b>	105148-1321	<b>9 430 610 422</b>	105780-8140	<b>9 430 610 168</b>
105118-6831	<b>9 430 613 447</b>	105140-1380	<b>9 430 610 299</b>	105148-1350	<b>9 430 610 426</b>	105780-8180	<b>9 430 613 641</b>
105118-6920	<b>9 430 613 530</b>	105141-1792	<b>9 430 610 310</b>	105148-1351	<b>F 01G 09X 06Z</b>	105780-8190	<b>9 430 610 134</b>
105118-6980	<b>9 430 613 575</b>	105141-1880	<b>9 430 610 003</b>	105148-1420	<b>9 430 610 170</b>	105780-8310	<b>9 430 613 457</b>
105118-7042	<b>9 430 610 151</b>	105141-1961	<b>9 430 610 004</b>	105148-1480	<b>9 430 610 158</b>	105780-8320	<b>9 430 613 755</b>
105118-7101	<b>9 430 612 703</b>	105141-1981	<b>9 430 610 320</b>	105148-1490	<b>9 430 610 159</b>	107714-0010	<b>0 445 020 010</b>
105118-7130	<b>9 430 612 707</b>	105141-2001	<b>9 430 610 058</b>	105148-1500	<b>9 430 610 160</b>	107716-0020	<b>0 445 020 012</b>
105118-7190	<b>9 430 612 716</b>	105141-2061	<b>9 430 610 150</b>	105148-1551	<b>9 430 610 442</b>	107750-0084	<b>0 445 110 085</b>
105118-7232	<b>9 430 612 719</b>	105141-2080	<b>9 430 610 005</b>	105148-1644	<b>F 01G 09X 070</b>	107750-0120	<b>0 445 110 091</b>
105118-7233	<b>9 430 613 634</b>	105141-2122	<b>9 430 610 331</b>	105148-1650	<b>9 430 613 543</b>	107750-0120	<b>0 986 435 154</b>
105118-7281	<b>9 430 610 167</b>	105141-2130	<b>0 986 433 010</b>	105148-1672	<b>F 01G 09X 06L</b>	107750-0152	<b>F 01G 09P 1XG</b>
105118-7331	<b>9 430 610 193</b>	105141-2130	<b>9 430 610 006</b>	105148-1680	<b>9 430 613 643</b>	107750-0173	<b>0 445 110 154</b>
105118-7372	<b>9 430 613 603</b>	105141-2240	<b>9 430 610 007</b>	105148-1702	<b>F 01G 09X 06M</b>	107750-0210	<b>0 445 110 172</b>
105118-7373	<b>9 430 613 958</b>	105141-2391	<b>0 986 433 012</b>	105148-1722	<b>F 01G 09X 06N</b>	107750-0222	<b>0 445 110 168</b>
105118-7380	<b>9 430 610 198</b>	105141-2391	<b>9 430 610 029</b>	105148-1822	<b>F 01G 09X 071</b>	107750-0260	<b>0 445 110 215</b>





107750-0272	<b>0 445 110 214</b>	109962-0050	<b>F 01G 09P 1P1</b>		
107750-0291	<b>0 445 110 227</b>	146019-0520	<b>9 460 610 202</b>		
107750-0390	<b>0 445 110 236</b>	146019-0620	<b>9 460 610 203</b>		
107750-0390	<b>0 986 435 145</b>	146019-2520	<b>9 460 610 208</b>		
107750-0500	<b>0 445 110 169</b>	159605-0422	<b>9 443 611 964</b>		
107750-0510	<b>0 445 110 262</b>	904740-0105	<b>F 01G 09W 0GV</b>		
107750-0600	<b>0 445 110 296</b>	904761-4056	<b>F 01G 09W 0H6</b>		
107750-0610	<b>F 01G 09P 1XK</b>	905101-8390	<b>F 01G 09P 29D</b>		
107750-0610	<b>0 445 110 307</b>	905110-4481	<b>F 01G 09X 03X</b>		
107750-0630	<b>0 445 110 284</b>	905110-4592	<b>F 01G 09X 03Y</b>		
107750-0640	<b>0 445 110 232</b>	905110-7891	<b>F 01G 09X 00G</b>		
107750-0650	<b>0 445 110 315</b>	905110-8062	<b>F 01G 09X 06K</b>		
107750-0660	<b>0 445 116 006</b>	905118-6641	<b>F 01G 09X 03W</b>		
107755-0065	<b>0 445 120 006</b>	905118-7950	<b>F 01G 09X 00J</b>		
107755-0073	<b>0 986 435 525</b>	907750-0152	<b>F 01G 09P 1XG</b>		
107755-0083	<b>0 986 435 531</b>	907750-0610	<b>F 01G 09P 1XK</b>		
107755-0091	<b>0 445 120 012</b>	907755-0161	<b>F 01G 09P 1XD</b>		
107755-0091	<b>0 986 435 525</b>	909342-4027	<b>F 01G 09R 00Y</b>		
107755-0101	<b>0 445 120 016</b>	909342-4033	<b>F 01G 09R 00Z</b>		
107755-0101	<b>0 986 435 531</b>	909342-4051	<b>F 01G 09R 00R</b>		
107755-0151	<b>F 01G 09P 1XB</b>	909342-4070	<b>F 01G 09R 00S</b>		
107755-0151	<b>0 445 120 047</b>	980900-0029	<b>0 445 020 042</b>		
107755-0162	<b>0 445 120 048</b>				
107755-0172	<b>0 445 120 049</b>				
107755-0200	<b>0 445 120 043</b>				
107755-0211	<b>0 445 120 058</b>				
107755-0220	<b>0 445 120 025</b>				
107755-0230	<b>0 445 120 073</b>				
107755-0240	<b>0 445 120 072</b>				
107755-0250	<b>0 445 120 059</b>				
107755-0280	<b>0 445 120 080</b>				
107755-0300	<b>0 445 120 091</b>				
107755-0320	<b>0 445 120 093</b>				
107755-0332	<b>0 445 120 095</b>				
107755-0341	<b>F 01F 09P 20Y</b>				
107755-0341	<b>0 445 120 090</b>				
107755-0350	<b>0 445 120 040</b>				
107755-0360	<b>0 445 120 076</b>				
107755-0380	<b>0 445 120 109</b>				
107755-0400	<b>0 445 120 041</b>				
107755-0420	<b>0 445 120 125</b>				
107755-0430	<b>0 445 120 145</b>				
107755-0440	<b>0 445 120 146</b>				
107755-0450	<b>F 01G 09P 1XV</b>				
107755-0460	<b>F 01G 09P 1XW</b>				
109341-1002	<b>0 470 504 030</b>				
109341-1011	<b>0 470 504 031</b>				
109341-1032	<b>0 470 504 044</b>				
109341-1042	<b>0 470 504 045</b>				
109341-2052	<b>0 470 504 012</b>				
109341-4014	<b>0 470 504 029</b>				
109341-4015	<b>0 470 504 029</b>				
109342-3002	<b>0 470 504 027</b>				
109342-4040	<b>0 470 504 034</b>				
109342-4070	<b>0 470 504 043</b>				





























<b>12V</b>	Vehicle electrical system voltage 12 V
<b>24V</b>	Vehicle electrical system voltage 24 V
<b>3T5</b>	For vehicles with 3.5 t gross permissible weight
<b>4T5</b>	For vehicles with 4.5 t gross permissible weight
<b>AA</b>	All-wheel drive
<b>AA</b>	Without all-wheel drive
<b>ABS</b>	For vehicles with ABS
<b>ABS</b>	For vehicles without ABS
<b>AG</b>	For vehicles with automatic transmission
<b>AGF</b>	For vehicles with emission control
<b>AGF</b>	For vehicles without emission control
<b>AGR</b>	Exhaust gas recirculation
<b>AGR</b>	Without exhaust gas recirculation
<b>ATW</b>	Note when ordering: Nozzle change not possible in nozzle and holder assembly with needle motion sensor. Product fitted must be determined on vehicle/engine.
<b>BIO</b>	For biofuel
<b>BIO</b>	Not for biofuel
<b>BKN</b>	Bosch equipment without cold starting system
<b>BO</b>	Bosch, only as replacement for Bosch equipment
<b>BOK</b>	Bosch equipment with cold start system
<b>BOW</b>	Bosch, only as replacement for Bosch equipment, for vehicles with immobilizer
<b>BOW</b>	Bosch, only as replacement for Bosch equipment, for vehicles without immobilizer
<b>BS1</b>	For BS 1 application
<b>BS2</b>	For BS 2 application
<b>CAV</b>	Interchangeable Bosch product or part for CAV
<b>CSA</b>	Product can also be ordered online "www.partbob.com"
<b>DBB</b>	Combustion chamber seal ring included
<b>DBJ</b>	Combustion chamber seal ring pre-assembled at injector
<b>DBJ</b>	Combustion chamber seal ring not included in scope of delivery
<b>DEP</b>	For Delphi system
<b>DKF</b>	Zexel production
<b>DRE</b>	Provision for rev counter connection
<b>E93</b>	For emission standard EEC 93
<b>E96</b>	For emission standard EEC 96
<b>EC9</b>	For emission standard EEC 99
<b>ECO</b>	For Ecomatic version
<b>EDC</b>	Electronic diesel control
<b>EE2</b>	For emission standard EEC 2000
<b>EEC</b>	For emission standard EEC V
<b>EFV</b>	Also replacement for predecessor
<b>EFZ</b>	Replacement for non-Bosch products, replace as a set
<b>EU2</b>	For vehicles with emission standard Euro 2
<b>EU2</b>	Not for emission standard Euro 2
<b>EU3</b>	For vehicles with emission standard Euro 3
<b>EU3</b>	Not for vehicles with emission standard Euro 3
<b>EU4</b>	For vehicles with emission standard Euro 4
<b>EU4</b>	Not for vehicles with emission standard Euro 4
<b>EU5</b>	For vehicles with emission standard Euro 5
<b>EU6</b>	Not for vehicles with emission standard Euro 5
<b>EU6</b>	For vehicles with emission standard Euro 6
<b>EXW</b>	Replacement of the eccentric shaft only in conjunction with gear pump 0 440 020 044
<b>FBH</b>	For high altitude operation
<b>FD3</b>	For emission standard D3
<b>FE2</b>	For Euro 2/B engines
<b>FE2</b>	Not for Euro 2/B engines
<b>FFK</b>	For front heater with air conditioner
<b>FHE</b>	For heater
<b>FKR</b>	For vehicles with short wheelbase
<b>FL5</b>	For emission standard L5
<b>FLR</b>	For vehicles with long wheelbase
<b>FMA</b>	For vehicles without airbag
<b>FMN</b>	For vehicles with power take-off
<b>FWT</b>	For heat exchanger
<b>GES</b>	For vehicles with cruise control system
<b>GES</b>	For vehicles without cruise control system
<b>GLA</b>	GL version
<b>GLX</b>	GLX version
<b>GRF</b>	Basic version
<b>GS</b>	For vehicles with manual transmission
<b>HAG</b>	For vehicles with semi-automatic transmission
<b>HEF</b>	For vehicles with heated windshield
<b>HEF</b>	For vehicles without heated windshield
<b>HL</b>	Altitude correction
<b>I1B</b>	For injector class 1, with code number 1 or blue color coding
<b>I2G</b>	For injector class 2, with code number 2 or green color coding
<b>I3K</b>	For injector class 3, with code number 3
<b>KAT</b>	For vehicles with catalytic converter
<b>KAT</b>	For vehicles without catalytic converter
<b>KKA</b>	With Class A marking
<b>KKX</b>	With class X marking
<b>KKY</b>	With class Y marking
<b>KKZ</b>	With class Z marking
<b>KL</b>	For vehicles with air conditioner
<b>KL</b>	For vehicles without air conditioner
<b>KOB</b>	For station wagon
<b>KSE</b>	Cold start device fitted
<b>KZB</b>	Identification: blue
<b>KZE</b>	Identification: yellow
<b>KZG</b>	Identification: green
<b>KZO</b>	Cold climates
<b>KZO</b>	Not for cold climates
<b>LH</b>	For vehicles with power steering
<b>LH</b>	For vehicles without power steering
<b>LLE</b>	For LHD vehicles
<b>LWG</b>	For delivery van
<b>MDR</b>	With rev counter
<b>MDR</b>	Without revolution counter
<b>MEB</b>	With Bosch injection system
<b>MG5</b>	For vehicles with 5-speed manual transmission
<b>MG6</b>	For vehicles with 6-speed manual transmission
<b>MKO</b>	For vehicles with air conditioner, without power steering
<b>MLK</b>	For vehicles with power steering and air conditioner
<b>MPR</b>	For vehicles with particulate filter
<b>MPR</b>	For vehicles without particulate filter
<b>MRQ</b>	For vehicles with maximum speed governor RQ
<b>MVR</b>	Variable speed governor, flush mounted
<b>N01</b>	For emission standard ECE R15.04
<b>N03</b>	For emission standard Euro 93 - CEE 19.5
<b>N05</b>	For emission standard Euro 96, CEE 95, L3
<b>N07</b>	For emission standard US 87
<b>N09</b>	For emission standard US 84 LDT
<b>N11</b>	For emission standard US 90 LDT
<b>N13</b>	For emission standard Euro 96
<b>N14</b>	For emission standard Euro 2000, CEE 2000
<b>N25</b>	For emission standard Euro 2005, EC 2005
<b>N25</b>	Not for emission standard Euro 2005, EC 2005
<b>N39</b>	For emission standard Euro 93 - CEE 19.5 and US 84 LDT
<b>NC8</b>	For emission value code NC8
<b>NC9</b>	For emission value code NC9
<b>NOR</b>	Standard version
<b>NT5</b>	For emission value code NT5
<b>OBD</b>	For vehicles with on-board diagnosis (OBD)
<b>OBD</b>	For vehicles without on-board diagnosis (OBD)
<b>OKN</b>	Without marking
<b>OLK</b>	For vehicles without power steering and without air conditioner
<b>OWK</b>	For vehicles without immobilizer, with air conditioner
<b>OWO</b>	For vehicles without immobilizer and without air conditioner
<b>RAP</b>	Suitable for RME (rapeseed oil methyl ester)
<b>RAP</b>	Not suitable for RME (rapeseed oil methyl ester)
<b>RLE</b>	For RHD vehicles
<b>RSA</b>	Color coding: Pink
<b>SCJ</b>	For vehicles with SCR (Selective Catalytic Reduction)
<b>SCJ</b>	For vehicles without SCR (Selective Catalytic Reduction)
<b>SFU</b>	Plug-in sensor, single
<b>SFZ</b>	For special-purpose vehicles
<b>SLX</b>	For vehicles with SLX equipment
<b>SSJ</b>	For vehicles with Start-Stop function
<b>SSJ</b>	For vehicles without Start-Stop function
<b>THE</b>	Technical trade restriction, replacement can only be obtained from the vehicle manufacturer
<b>THI</b>	After replacing pump control unit or injection pump, immobilizer must be activated at a vehicle manufacturer's franchised workshop.
<b>THS</b>	After installing the injection pump, the control unit must be programmed at a vehicle manufacturer's franchised workshop.
<b>TNK</b>	The vehicle data card is required for definite identification of the Bosch number. The components listed with the product must coincide with those on the data card.
<b>TW</b>	The product fitted must be identified on the vehicle or engine
<b>U18</b>	Early production
<b>U26</b>	Late models
<b>UPE</b>	If 0 928 400 527 is installed as replacement for 0 928 400 314, the control unit must be re-programmed at a BMW workshop
<b>VAE</b>	For vehicles with more stringent emission control
<b>VGT</b>	VGT engine
<b>VP4</b>	Attention! Note VW no. at pump. 059 130 106 A: order 0 470 506 046 or exchange 0 986 444 033. 059 130 106 D: order 0 470 506 002 or exchange 0 986 444 006.
<b>WAS</b>	With water separator
<b>WAS</b>	Without water separator
<b>WEG</b>	For vehicles with immobilizer
<b>WEG</b>	For vehicles without immobilizer
<b>WEI</b>	Color coding: white
<b>WEK</b>	For vehicles with immobilizer and air conditioner
<b>WFS</b>	Control unit with integrated immobilizer function
<b>WGT</b>	VGT engine
<b>WOK</b>	For vehicles with immobilizer, without air conditioner
<b>WW</b>	Optional

**WZT** For vehicles with immobilizer, release via ignition key (transponder system)

**X10** For cylinder 1

**X56** For cylinders 2 - 6

<sup>1</sup> with needle travel sensor

	Passenger cars		O-ring
	Commercial vehicles		Common Rail Injector
	Agricultural machine / construction machine		Common-Rail high-pressure pump
	Stator engine / built-in engine		Distributor pump VE and VR
	Piston displacement in l		Air mass meter
	Engine power output in kW		Unit Injection System UIS
	Engine type		Unit pump system UPS
	Number of cylinders		Unit Injector System (UIS)
	Export market		Denoxtronic delivery module
	Date/ Production period		Page reference
	Special case		
	Information/Explanations		
	Part number		
	Exchange number		
	Arrow N		
	Nozzle-and-holder assembly		
	Cylinder head/thermal protection disc DHK sealing ring		
	DHK fuel leakage connection sealing ring		



<b>12V</b>	Tension de bord 12 V
<b>24V</b>	Tension de bord 24 V
<b>3T5</b>	Pour les véhicules avec un PTAC de 3,5 t
<b>4T5</b>	Pour les véhicules avec un PTAC de 4,5 t
<b>AA</b>	Transmission intégrale
<b>AA</b>	Sans transmission intégrale
<b>ABS</b>	Pour véhicules avec ABS
<b>ABS</b>	Pour véhicules sans ABS
<b>AG</b>	Pour véhicules avec boîte automatique
<b>AGF</b>	Pour véhicules av. dépollution de l'échap.
<b>AGF</b>	Pour véhicules ss dépollution de l'échap.
<b>AGR</b>	Recyclage des gaz d'échappement
<b>AGR</b>	Sans recyclage des gaz d'échappement
<b>ATW</b>	Attention à la commande : l'injecteur de l'ensemble injecteur/porte-injecteur avec capteur de déplacement d'aiguille ne peut pas être remplacé. Le produit installé doit être déterminé sur le véhicule ou le moteur.
<b>BIO</b>	Pour biocarburant
<b>BIO</b>	Pas pour biocarburant
<b>BKN</b>	Équipement Bosch sans dispositif de démarrage à froid
<b>BO</b>	Bosch, uniquement comme remplacement pour équipement Bosch
<b>BOK</b>	Équipement Bosch avec dispositif de démarrage à froid
<b>BOW</b>	Bosch, uniquement comme remplacement pour équipement Bosch, pour véhicules avec antidémarrage.
<b>BOW</b>	Bosch, uniquement comme remplacement pour équipement Bosch, pour véhicules sans antidémarrage
<b>BS1</b>	Pour application BS 1
<b>BS2</b>	Pour application BS 2
<b>CAV</b>	Produit Bosch équivalent ou pièce pour CAV
<b>CSA</b>	Produit disponible également en ligne "www.partbob.com"
<b>DBB</b>	Joint de chambre de combustion joint
<b>DBJ</b>	Joint de chambre de combustion prémonté sur l'injecteur
<b>DBJ</b>	Joint circulaire de chambre de combustion non compris dans la livraison
<b>DEP</b>	Pour système Delphi
<b>DKF</b>	Fabrication "Zexel"
<b>DRE</b>	Branchement du compte-tours prévu
<b>E93</b>	Pour norme antipollution CEE 93
<b>E96</b>	Pour norme antipollution CEE 96
<b>EC9</b>	Pour norme antipollution CEE 99
<b>ECO</b>	Pour version Ecomatic
<b>EDC</b>	Régulation électronique diesel
<b>EE2</b>	Pour norme antipollution CEE 2000
<b>EEC</b>	Pour norme antipollution CEE V
<b>EFV</b>	Remplacement aussi pour ancien modèle
<b>EFZ</b>	Remplacement pour produits d'autre marque, à remplacer par lots complets
<b>EU2</b>	Pour véhicules avec norme antipollution Euro 2
<b>EU2</b>	Pas pour norme antipollution Euro 2
<b>EU3</b>	Pour véhicules avec norme antipollution Euro 3
<b>EU3</b>	Pas pour les véhicules selon la norme antipollution Euro 3
<b>EU4</b>	Pour véhicules avec norme antipollution Euro 4
<b>EU4</b>	Pas pour les véhicules selon la norme antipollution Euro 4
<b>EU5</b>	Pour véhicules avec norme antipollution Euro 5
<b>EU5</b>	Pas pour les véhicules selon la norme antipollution Euro 5
<b>EU6</b>	Pour véhicules avec norme antipollution Euro 6
<b>EXW</b>	Remplacement de l'arbre excentrique uniquement en liaison avec la pompe à engrenage 0 440 020 044
<b>FBH</b>	Pour fonctionnement en altitude
<b>FD3</b>	Pour norme antipollution D3
<b>FE2</b>	Pour moteurs Euro 2/B
<b>FE2</b>	Pas pour moteurs Euro 2/B
<b>FFK</b>	Pour chauffage avant avec climatiseur
<b>FHE</b>	Pour chauffage
<b>FKR</b>	Pour véhicules à empattement court
<b>FL5</b>	Pour norme antipollution L5
<b>FLR</b>	Pour véhicules à empattement long
<b>FMA</b>	Pour véhicules sans airbag
<b>FMN</b>	Pour véhicules à arbre de sortie auxiliaire
<b>FWT</b>	Pour échangeur de chaleur
<b>GES</b>	Pour véhicules avec régulateur de vitesse
<b>GES</b>	Pour véhicules sans régulateur de vitesse
<b>GLA</b>	Version GL
<b>GLX</b>	Version GLX
<b>GRF</b>	Version de base
<b>GS</b>	Pour véhicules avec boîte manuelle
<b>HAG</b>	Pour véhicules avec boîte semi-automatique
<b>HEF</b>	Pour véhicules avec pare-brise chauffant
<b>HEF</b>	Pour véhicules sans pare-brise chauffant
<b>HL</b>	Correction altimétrique
<b>I1B</b>	Pour injecteur classe 1, avec code 1 ou code couleur bleu
<b>I2G</b>	Pour injecteur classe 2, avec code 2 ou code couleur vert
<b>I3K</b>	Pour injecteur classe 3, avec code 3
<b>KAT</b>	Pour véhicules avec catalyseur
<b>KAT</b>	Pour véhicules sans catalyseur
<b>KKA</b>	Avec désignation classe A
<b>KKX</b>	Avec désignation classe X
<b>KKY</b>	Avec désignation classe Y
<b>KKZ</b>	Avec désignation classe Z
<b>KL</b>	Pour véhicules avec climatiseur
<b>KL</b>	Pour véhicules sans climatiseur
<b>KOB</b>	Pour break
<b>KSE</b>	Avec dispositif de démarrage à froid
<b>KZB</b>	Identifiant : bleu
<b>KZE</b>	Identifiant : jaune
<b>KZG</b>	Identifiant : vert
<b>KZO</b>	Zones froides
<b>KZØ</b>	Pas pour zones froides
<b>LH</b>	Pour véhicules avec direction assistée
<b>LH</b>	Pour véhicules sans direction assistée
<b>LLE</b>	Pour véhicules avec direction à gauche
<b>LWG</b>	Pour fourgonnette
<b>MDR</b>	Avec compte-tours
<b>MDR</b>	Sans compte-tours
<b>MEB</b>	Avec système d'injection Bosch
<b>MG5</b>	Pour véhicules avec boîte manuelle, 5 rapports
<b>MG6</b>	Pour véhicules avec boîte manuelle, 6 rapports
<b>MKO</b>	Pour véhicules avec climatiseur, sans direction assistée
<b>MLK</b>	Pour véhicules avec direction assistée et climatiseur
<b>MPR</b>	Pour véhicules avec filtre à particules
<b>MPR</b>	Pour véhicules sans filtre à particules
<b>MRQ</b>	Pour véhicules avec régulateur de vitesse maximale RQ
<b>MVR</b>	Avec régulateur toutes vitesses
<b>N01</b>	Pour norme antipollution ECE R15.04
<b>N03</b>	Pour norme antipollution Euro 93 - CEE 19.5
<b>N05</b>	Pour norme antipollution Euro 96, CEE 95, L3
<b>N07</b>	Pour norme antipollution US 87
<b>N09</b>	Pour norme antipollution US 84 LDT
<b>N11</b>	Pour norme antipollution US 90 LDT
<b>N13</b>	Pour norme antipollution Euro 96
<b>N14</b>	Pour norme antipollution Euro 2000, CEE 2000
<b>N25</b>	Pour norme antipollution Euro 2005, CE 2005
<b>N25</b>	Pas pour la norme antipollution Euro 2005, CE 2005
<b>N39</b>	Pour norme antipollution Euro 93 - CEE 19.5 et US 84 LDT
<b>NC8</b>	Pour code d'émission NC8
<b>NC9</b>	Pour code d'émission NC9
<b>NOR</b>	Version standard
<b>NT5</b>	Pour code d'émission NT5
<b>OBD</b>	Pour véhicules avec diagnostic embarqué (OBD)
<b>OBD</b>	Pour véhicules sans diagnostic embarqué (OBD)
<b>OKN</b>	Sans désignation
<b>OLK</b>	Pour véhicules sans direction assistée ni climatiseur
<b>OWK</b>	Pour véhicules sans antidémarrage, avec climatiseur
<b>OWO</b>	Pour véhicules sans antidémarrage ni climatiseur
<b>RAP</b>	Adapté RME (ester méthylique d'huile de colza)
<b>RAP</b>	Non adapté RME (ester méthylique d'huile de colza)
<b>RLE</b>	Pour véhicules avec direction à droite
<b>RSA</b>	Code couleur rose
<b>SCJ</b>	Pour véhicules avec SCR (Selective Catalytic Reduction)
<b>SGJ</b>	Pour véhicules sans SCR (Selective Catalytic Reduction)
<b>SFU</b>	Capteur enfichable, séparé
<b>SFZ</b>	Pour véhicules spéciaux
<b>SLX</b>	Pour véhicules avec équipement SLX
<b>SSJ</b>	Pour véhicules avec fonction démarrage-arrêt
<b>SSJ</b>	Pour véhicules sans fonction démarrage-arrêt
<b>THE</b>	Restriction commerciale technique, les pièces de rechange ne peuvent être commandées qu'auprès du constructeur
<b>THI</b>	Après le remplacement de la centrale de commande de la pompe ou de la pompe d'injection, l'antidémarrage doit être activé chez un concessionnaire du constructeur.
<b>THS</b>	La centrale de commande doit être programmée chez un concessionnaire du constructeur après la pose de la pompe d'injection.
<b>TNK</b>	Vous devez disposer de la carte signalétique du véhicule pour l'identification exacte de la référence Bosch. Les composants énumérés pour le produit doivent correspondre à ceux de la carte signalétique.
<b>TW</b>	Le produit monté doit être déterminé sur le véhicule ou le moteur.
<b>U18</b>	Production ancienne
<b>U26</b>	Modèles récents
<b>UPE</b>	Si 0 928 400 527 est monté en remplacement de 0 928 400 314, La centrale de cde doit être reprogrammée par un atelier BMW.
<b>VAE</b>	Pour véhicules avec dépollution accrue de l'échappement
<b>VGT</b>	Moteur VGT

**VP4** Attention! Observer le n° VW sur la pompe. 059 130 106 A: commander 0 470 506 046 ou remplacement 0 986 444 033. 059 130 106 D: commander 0 470 506 002 ou remplacement 0 986 444 006.

**WAS** Avec séparateur d'eau

**WAS** Sans séparateur d'eau

**WEG** Pour véhicules avec antidémarrage

**WEG** Pour véhicules sans antidémarrage

**WEI** Code couleur : blanc

**WEK** Pour véhicules avec antidémarrage et climatiseur

**WFS** Centrale de cde avec fonction anti-démarrage intégrée

**WGT** Moteur WGT

**WOK** Pour véhicules avec antidémarrage, sans climatiseur





























**WW** Au choix

**WZT** Pour véhicules avec antidémarrage, activation avec la clé de contact (système à transpondeur)

**X10** Pour cylindre 1

**X56** Pour cylindres 2 à 6

<sup>1</sup> Avec capteur de déplacement d'aiguille

	Voiture particulière		Joint circulaire culasse/rondelle calorifuge DHK
	Véhicule utilitaire		Joint circulaire raccord d'huile de fuite DHK
	Machine agricole ou machine de travaux publics		Joint torique
	Moteur stationnaire / moteur incorporé		Injecteur Common Rail
	Cylindrée en l		Pompe haute pression Common Rail
	Puissance du moteur en kW		Pompe d'injection distributrice VE et VR
	Type de moteur		Débitmètre d'air massique
	Nombre de cylindres		Unit Injection System UIS (système inject.-pompe)
	Pays d'exportation		Unit Pump System UPS
	Date/période de montage		Unité pompe-injecteur
	Cas spécial		Module d'alimentation Denoxtronic
	Information / explication		Renvoi à la page
	Référence		
	Numéro de remplacement		
	Flèche N		
	Ensemble injecteur/porte-injecteur		



<b>12V</b>	Tensione di bordo 12 Volt
<b>24V</b>	Tensione di bordo 24 Volt
<b>3T5</b>	Per veicoli con peso massimo complessivo ammesso di 3,5 t
<b>4T5</b>	Per veicoli con peso massimo complessivo ammesso di 4,5 t
<b>AA</b>	Trazione integrale
<b>AA</b>	Senza trazione integrale
<b>ABS</b>	Per veicoli con ABS
<b>ABS</b>	Per veicoli senza ABS
<b>AG</b>	Per veicoli con cambio automatico
<b>AGF</b>	Per veicoli con depurazione dei gas di scarico
<b>AGF</b>	Per veicoli senza depurazione dei gas di scarico
<b>AGR</b>	Ricircolo gas di scarico
<b>AGR</b>	Senza ricircolo dei gas di scarico
<b>ATW</b>	Da considerare al momento dell'ordinazione: nel gruppo portapolverizzatore completo, dotato di sensore spostamento ago non è possibile sostituire il polverizzatore. Il prodotto installato deve essere verificato sul veicolo/motore.
<b>BIO</b>	Per biodiesel
<b>BIO</b>	Non per biodiesel
<b>BKN</b>	Equipaggiamento Bosch senza dispositivo per avviamento a freddo
<b>BO</b>	Solo come ricambio per l'equipaggiamento Bosch
<b>BOK</b>	Equipaggiamento Bosch con dispositivo di avviamento a freddo
<b>BOW</b>	Bosch, solo come ricambio dell'equipaggiamento Bosch, per veicoli con immobilizzatore.
<b>BOW</b>	Bosch, solo come ricambio per equipaggiamento Bosch, per veicoli senza immobilizzatore
<b>BS1</b>	Per applicazione BS 1
<b>BS2</b>	Per applicazione BS 2
<b>CAV</b>	Prodotto o parte Bosch di dimensioni identiche per CAV
<b>CSA</b>	Prodotto ordinabile anche online "www.partbob.com"
<b>DBB</b>	Anello di tenuta camera di combustione accluso
<b>DBJ</b>	Anello di tenuta camera di combustione premontato sull'iniettore
<b>DBJ</b>	Anello di tenuta camera di combustione non compreso nel volume di fornitura
<b>DEP</b>	Per sistema Delphi
<b>DKF</b>	Fabbricazione "Zexel"
<b>DRE</b>	Con collegamento per il contagiri
<b>E93</b>	Per norma sui gas di scarico EEC 93
<b>E96</b>	Per norma sui gas di scarico EEC 96
<b>EC9</b>	Per norma sui gas di scarico EEC 99
<b>ECO</b>	Per versione Ecomatic
<b>EDC</b>	Regolazione elettronica, diesel
<b>EE2</b>	Per norma gas di scarico EEC 2000
<b>EEC</b>	Per norma gas di scarico EEC V
<b>EFV</b>	Ricambio anche per il modello precedente
<b>EFZ</b>	Ricambio per prodotto di altra marca, sostituire tutta la serie
<b>EU2</b>	Per veicoli con norma sui gas di scarico Euro 2
<b>EU2</b>	Non per norma sui gas di scarico Euro 2
<b>EU3</b>	Per veicoli con norma sui gas di scarico Euro 3
<b>EU3</b>	Non per veicoli con norma gas di scarico Euro 3
<b>EU4</b>	Per veicoli con norma sui gas di scarico Euro 4
<b>EU4</b>	Non per veicoli con norma gas di scarico Euro 4
<b>EU5</b>	Per veicoli con norma sui gas di scarico Euro 5
<b>EU5</b>	Non per veicoli con norma gas di scarico Euro 5
<b>EU6</b>	Per veicoli con norma sui gas di scarico Euro 6
<b>EXW</b>	Sostituzione dell'albero eccentrico solo in combinazione con la pompa ad ingranaggi 0 440 020 044
<b>FBH</b>	Per l'utilizzo ad alta quota
<b>FD3</b>	Per norma gas di scarico D3
<b>FE2</b>	Per Euro 2/B-Motore
<b>FE2</b>	Non per Euro 2/B-Motore
<b>FFK</b>	Per riscaldamento frontale con climatizzatore
<b>FHE</b>	Per riscaldamento
<b>FKR</b>	Per veicoli a passo corto
<b>FL5</b>	Per norma gas di scarico L5
<b>FLR</b>	Per veicoli a passo lungo
<b>FMA</b>	Per veicoli senza airbag
<b>FMN</b>	Per veicoli con presa di forza
<b>FWT</b>	Per scambiatore di calore
<b>GES</b>	Per veicoli con impianto di regolazione velocità
<b>GES</b>	Per veicoli senza impianto di regolazione velocità
<b>GLA</b>	Versione GL
<b>GLX</b>	Versione GLX
<b>GRF</b>	Versione base
<b>GS</b>	Per veicoli con cambio meccanico
<b>HAG</b>	Per veicoli con cambio semiautomatico
<b>HEF</b>	Per veicoli con parabrezza termico
<b>HEF</b>	Per veicoli senza parabrezza riscaldabile
<b>HL</b>	Correzione altezza
<b>I1B</b>	Per iniettore classe 1, con numero identificazione 1 o contrassegno blu
<b>I2G</b>	Per iniettore classe 2, con numero identificazione 2 o contrassegno verde
<b>I3K</b>	Per iniettore classe 3, con numero identificazione 3
<b>KAT</b>	Per veicoli con catalizzatore
<b>KAT</b>	Per veicoli senza catalizzatore
<b>KKA</b>	Con sigla classe A
<b>KKX</b>	Con sigla classe X
<b>KKY</b>	Con sigla classe Y
<b>KKZ</b>	Con sigla classe Z
<b>KL</b>	Per veicoli con climatizzatore
<b>KL</b>	Per veicoli senza climatizzatore
<b>KOB</b>	Per station wagon
<b>KSE</b>	Con dispositivo per avviamento a freddo incorporato
<b>KZB</b>	Contrassegno: blu
<b>KZE</b>	Contrassegno: giallo
<b>KZG</b>	Contrassegno: verde
<b>KZO</b>	Per zone fredde
<b>KZO</b>	Non per zone fredde
<b>LH</b>	Per veicolo con servosterzo
<b>LH</b>	Per veicoli senza servosterzo
<b>LLE</b>	Per guida a sinistra
<b>LWG</b>	Per furgone per consegne
<b>MDR</b>	Con contagiri
<b>MDR</b>	Senza contagiri
<b>MEB</b>	Con sistema di iniezione Bosch
<b>MG5</b>	Per veicoli con cambio meccanico a 5 marce
<b>MG6</b>	Per veicoli con cambio meccanico a 6 marce
<b>MKO</b>	Per veicoli con climatizzatore, senza servosterzo
<b>MLK</b>	Per veicoli con servosterzo e climatizzatore
<b>MPR</b>	Per veicoli con filtro antiparticolato
<b>MPR</b>	Per veicoli senza filtro antiparticolato
<b>MRQ</b>	Per veicoli con regolatore del numero di giri massimo RQ
<b>MVR</b>	Con regolatore d'anticipo integrato
<b>N01</b>	Per norma gas di scarico ECE R15.04
<b>N03</b>	Per norma gas di scarico Euro 93 - CEE 19.5
<b>N05</b>	Per norma gas di scarico Euro 96, CEE 95, L3
<b>N07</b>	Per norma gas di scarico US 87
<b>N09</b>	Per norma gas di scarico US 84 LDT
<b>N11</b>	Per norma gas di scarico US 90 LDT
<b>N13</b>	Per norma gas di scarico Euro 96
<b>N14</b>	Per norma gas di scarico Euro 2000, CEE 2000
<b>N25</b>	Per norma gas di scarico Euro 2005, EC 2005
<b>N25</b>	Non per norma gas di scarico Euro 2005, EC 2005
<b>N39</b>	Per norma gas di scarico Euro 93 - CEE 19.5 e US 84 LDT
<b>NC8</b>	Per codice valori gas di scarico NC8
<b>NC9</b>	Per codice valori gas di scarico NC9
<b>NOR</b>	Versione normale
<b>NT5</b>	Per codice valori gas di scarico NT5
<b>OBD</b>	Per veicoli con diagnosi On-Board (OBD)
<b>OBD</b>	Per veicoli senza diagnosi On-Board (OBD)
<b>OKN</b>	Senza contrassegno
<b>OLK</b>	Per veicoli senza servosterzo e senza climatizzatore
<b>OWK</b>	Per veicoli senza immobilizzatore, con climatizzatore
<b>OWO</b>	Per veicoli senza immobilizzatore e senza climatizzatore
<b>RAP</b>	Compatibile RME (estere metilico da olio di colza)
<b>RAP</b>	Non compatibile RME (estere metilico da olio di colza)
<b>RLE</b>	Per guida a destra
<b>RSA</b>	Contrassegno colorato rosa
<b>SCJ</b>	Per veicoli con SCR (Selective Catalytic Reduction)
<b>SCJ</b>	Per veicoli senza SCR (Selective Catalytic Reduction)
<b>SFU</b>	Sensore ad innesto, singolo
<b>SFZ</b>	Per veicoli speciali
<b>SLX</b>	Per veicoli con equipaggiamento SLX
<b>SSJ</b>	Per veicoli con funzione di avviamento/arresto
<b>SSJ</b>	Per veicoli senza funzione di avviamento/arresto
<b>THE</b>	Limitazione tecnica per il commercio, il ricambio può essere acquistato solo presso il costruttore del veicolo
<b>THI</b>	Dopo la sostituzione della centralina pompa o della pompa di iniezione è necessario attivare l'immobilizzatore in un'officina autorizzata del costruttore del veicolo.
<b>THS</b>	Dopo il montaggio della pompa di iniezione la centralina deve essere programmata in un'officina autorizzata del costruttore del veicolo.
<b>TNK</b>	Per un'identificazione sicura del numero Bosch deve essere disponibile la scheda dati del veicolo. I componenti riportati sul prodotto devono coincidere con quelli nella scheda dati.
<b>TW</b>	Il prodotto montato deve essere rilevato sul veicolo o sul motore.
<b>U18</b>	Prima produzione
<b>U26</b>	Modelli successivi
<b>UPE</b>	Se viene montato 0 928 400 527 in sostituzione di 0 928 400 314, la centralina deve essere riprogrammata da un'officina BMW.
<b>VAE</b>	Per veicoli con depurazione dei gas di scarico potenziata
<b>VGT</b>	Motore VGT

**VP4** Attenzione! Prestare attenzione al n. VW sulla pompa. 059 130 106 A: ordinare 0 470 506 046 oppure componente intercambiabile 0 986 444 033. 059 130 106 D: ordinare 470.506.002 oppure componente intercambiabile 986.444.006.

**WAS** Con separatore acqua

**WAS** Senza separatore acqua

**WEG** Per veicoli con immobilizzatore

**WEG** Per veicoli senza immobilizzatore

**WEI** Contrassegno colorato: bianco

**WEK** Per veicoli con immobilizzatore e climatizzatore

**WFS** Centralina elettronica con funzione immobilizzatore integrata

**WGT** Motore WGT

**WOK** Per veicoli con immobilizzatore, senza climatizzatore

**WW** A scelta

**WZT** Per veicoli con immobilizzatore, abilitabile tramite chiave di accensione (sistema Transponder)

**X10** Per cilindro 1

**X56** Per cilindri 2 - 6

<sup>1</sup> Con sensore movimento ago



Autovettura



Veicolo commerciale



Trattore o macchina per l'edilizia



Motore stazionario / motore incorporato



Cilindrata in l



Potenza motore in kW



Tipo motore



Numero cilindri



Paese d'esportazione



Data/Periodo di montaggio



Caso specifico



Informazione / dichiarazione



Numero di ordinazione



Numero sostituzione



N. freccia



Combinazione portapolverizzatori



Anello di tenuta testata/rondella termoisolante DHK



Anello di tenuta raccordo carburante di recupero DHK



O-ring



Common Rail Injector



Pompa alta pressione Common Rail



Pompa iniezione rotativa VE e VR



Misuratore della massa d'aria



Unit Injection System UIS (unità pompa-iniettore)



Unit Pump System UPS



Unità pompa-iniettore (PDE)



Modulo di alimentazione Denoxtronic



Rimando ad un'altra pagina



<b>12V</b>	Tensión de a bordo de 12 Voltios	<b>EU4</b>	Para vehículos con norma de gases de escape EURO 4	<b>MG5</b>	Para vehículos con cambio manual, 5 marchas
<b>24V</b>	Tensión de a bordo 24 Voltios	<b>EU4</b>	No para vehículos con norma de gases de escape Euro 4	<b>MG6</b>	Para vehículos con cambio manual, 6 marchas
<b>3T5</b>	Para vehículos con un peso total admisible de 3,5 t	<b>EU5</b>	Para vehículos con norma de gases de escape EURO 5	<b>MKO</b>	Para vehículos con acondicionador de aire sin servodirección
<b>4T5</b>	Para vehículos con un peso total admisible de 4,5 t	<b>EU5</b>	No para vehículos con norma de gases de escape Euro 5	<b>MLK</b>	Para vehículos con servodirección y con acondicionador de aire
<b>AA</b>	Tracción total	<b>EU6</b>	Para vehículos con norma de gases de escape EURO 6	<b>MPR</b>	Para vehículos con filtro de partículas de hollín
<b>AA</b>	Sin tracción total	<b>EXW</b>	Sustitución del árbol excéntrico sólo en combinación con la bomba de engranajes 0 440 020 044	<b>MPR</b>	Para vehículos sin filtro de partículas de hollín
<b>ABS</b>	Para vehículos con ABS	<b>FBH</b>	Para el funcionamiento en grandes alturas	<b>MRQ</b>	Para vehículos con regulador del número final de revoluciones RQ
<b>ABS</b>	Para vehículos sin ABS	<b>FD3</b>	Para norma de gases de escape D3	<b>MVR</b>	Con regulador de ajuste, incorporado
<b>AG</b>	Para vehículos con cambio automático	<b>FE2</b>	Para Euro 2/Motores B	<b>NO1</b>	Para norma de gases de escape ECE R15.04
<b>AGF</b>	Para vehículos con desintoxicación de gases de escape	<b>FE2</b>	No para Euro 2/Motores B	<b>NO3</b>	Para norma de gases de escape Euro 93 - CEE 19.5
<b>AGF</b>	Para vehículos sin desintoxicación de gases de escape	<b>FFK</b>	Para calefacción de la parte delantera con acondicionador de aire	<b>NO5</b>	Para norma de gases de escape Euro 96, CEE 95, L3
<b>AGR</b>	Retroalimentación de gases de escape	<b>FHE</b>	Para calefacción	<b>NO7</b>	Para norma de gases de escape US 87
<b>AGR</b>	Sin retroalimentación de gases de escape	<b>FKR</b>	Para vehículos con corta distancia entre ejes	<b>NO9</b>	Para norma de gases de escape US 84 LDT
<b>ATW</b>	En el conjunto inyector con detector de movimientos de aguja no es posible el cambio de inyector. Tenerlo en cuenta al cursar el pedido. El producto instalado tiene que averiguarse en el vehículo/motor.	<b>FL5</b>	Para norma de gases de escape L5	<b>N11</b>	Para norma de gases de escape US 90 LDT
<b>BIO</b>	Para biocarburante	<b>FLR</b>	Para vehículos con larga distancia entre ejes	<b>N13</b>	Para norma de gases de escape EURO 96
<b>BIO</b>	No para biocarburante	<b>FMA</b>	Para vehículos sin airbag	<b>N14</b>	Para norma de gases de escape Euro 2000, CEE 2000
<b>BKN</b>	Equipamiento Bosch sin dispositivo de arranque en frío	<b>FMN</b>	Para vehículos con toma de fuerza auxiliar	<b>N25</b>	Para norma de gases de escape Euro 2005, EC 2005
<b>BO</b>	Bosch, sólo como producto de sustitución para el equipo Bosch	<b>FWT</b>	Para intercambiador de calor	<b>N25</b>	No para norma de gases de escape Euro 2005, EC 2005
<b>BOK</b>	Equipo Bosch con dispositivo de arranque en frío	<b>GES</b>	Para vehículos con sistema regulador de la velocidad	<b>N39</b>	Para norma de gases de escape Euro 93 - CEE 19.5 y US 84 LDT
<b>BOW</b>	Bosch, sólo como producto de sustitución para el equipo Bosch, para vehículos con dispositivo electrónico de inmovilización.	<b>GLA</b>	Para vehículos sin instalación reguladora de velocidad	<b>NC8</b>	Para código de valores de gases de escape NC8
<b>BOW</b>	Bosch, sólo como repuesto para equipo Bosch, para vehículos sin inmovilizador electrónico	<b>GLX</b>	Versión GLX	<b>NC9</b>	Para código de gas de escape NC9
<b>BS1</b>	Para BS 1, aplicación	<b>GRF</b>	Modelo básico	<b>NOR</b>	Versión normal
<b>BS2</b>	Para BS 2, aplicación	<b>GS</b>	Para vehículos con cambio manual	<b>NT5</b>	Para código de valor de gases de escape NT5
<b>CAV</b>	Producto Bosch de dimensiones idénticas para CAV	<b>HAG</b>	Para vehículos con cambio semiautomático	<b>OBD</b>	Para vehículos con diagnóstico de a bordo (OBD)
<b>CSA</b>	Producto también por pedido online "www.partbob.com"	<b>HEF</b>	Para vehículos con parabrisas calefactable	<b>ØBD</b>	Para vehículos sin diagnóstico de a bordo (OBD)
<b>DBB</b>	Junta de cámara de combustión adjunta	<b>HEF</b>	Para vehículos sin parabrisas calefactable	<b>OKN</b>	Sin designación
<b>DBJ</b>	Junta de cámara de combustión premontada en inyector	<b>HL</b>	Corrección de altura	<b>OLK</b>	Para vehículos sin servodirección y sin acondicionador de aire
<b>ØBj</b>	Junta anular de cámara de combustión no contenida en volumen de suministro	<b>I1B</b>	Para inyector clase 1, con código 1 o caracterización de color azul	<b>OWK</b>	Para vehículos sin inmovilizador electrónico con acondicionador de aire
<b>DEP</b>	Para sistema Delphi	<b>I2G</b>	Para inyector clase 2, con código 2 o caracterización de color verde	<b>OWO</b>	Para vehículos sin inmovilizador electrónico y sin acondicionador de aire
<b>DKF</b>	Fabricación ""Zexel""	<b>I3K</b>	Para inyector clase 3, con código 3	<b>RAP</b>	Apto RME (éster metílico aceite de colza)
<b>DRE</b>	Con conexión para el cuentarrevoluciones	<b>KAT</b>	Para vehículos con catalizador	<b>RAP</b>	No apto RME (éster metílico aceite de colza)
<b>E93</b>	Para norma de gases de escape EEC 93	<b>KAT</b>	Para vehículos sin catalizador	<b>RLE</b>	Para vehículos de volante a la derecha
<b>E96</b>	Para norma de gases de escape EEC 96	<b>KKA</b>	Con identificación clase A	<b>RSA</b>	Caracterización de color rosa
<b>EC9</b>	Para norma de gases de escape EEC 99	<b>KKX</b>	Con identificación clase X	<b>SCJ</b>	Para vehículos con SCR (Selective Catalytic Reduction)
<b>ECO</b>	Para versión Ecomatic	<b>KKY</b>	Con identificación clase Y	<b>SCJ</b>	Para vehículos sin SCR (Selective Catalytic Reduction)
<b>EDC</b>	Regulación electrónica diesel	<b>KKZ</b>	Con identificación clase Z	<b>SFU</b>	Sensor de enchufe, individual
<b>EE2</b>	Para norma de gases de escape EEC 2000	<b>KL</b>	Para vehículos con acondicionador de aire	<b>SFZ</b>	Para vehículos especiales
<b>EEC</b>	Para norma de gases de escape EEC V	<b>KL</b>	Para vehículos sin acondicionador de aire	<b>SLX</b>	Para vehículos con equipamiento SLX
<b>EFV</b>	También sustitución del anterior	<b>KOB</b>	Para vehículos combinados	<b>SSJ</b>	Para vehículos con función de arranque/parada
<b>EFZ</b>	Sustituye producto de otra marca, cambiar por juegos	<b>KSE</b>	Dispositivo de arranque en frío incorporado	<b>SSJ</b>	Para vehículos sin función de arranque/parada
<b>EU2</b>	Para vehículos con norma de gases de escape EURO 2	<b>KZB</b>	Distintivo característico de color: azul	<b>THE</b>	Restricciones técnicas del comercio, el recambio sólo se puede adquirir del fabricante del vehículo
<b>EU2</b>	No para norma de gases de escape Euro 2	<b>KZE</b>	Distintivo característico: amarillo	<b>THI</b>	Tras cambiar la unidad de mando de la bomba o la bomba de inyección, debe activarse el inmovilizador electrónico en un taller concertado del fabricante de automóviles.
<b>EU3</b>	Para vehículos con norma de gases de escape EURO 3	<b>KZG</b>	Distintivo característico: verde	<b>THS</b>	La unidad de mando se debe programar en un taller bajo contrato del fabricante del vehículo, tras el montaje de la bomba de inyección.
<b>EU3</b>	No para vehículos con norma de gases de escape Euro 3	<b>KZO</b>	Para zonas frías		
		<b>KZØ</b>	No para zonas frías		
		<b>LH</b>	Para vehículos con servodirección		
		<b>LH</b>	Para vehículos sin dirección asistida		
		<b>LLE</b>	Para dirección a la izquierda		
		<b>LWG</b>	Para vehículos de reparto		
		<b>MDR</b>	Con cuentarrevoluciones		
		<b>MDR</b>	Sin cuentarrevoluciones		
		<b>MEB</b>	Con sistema de inyección Bosch		



<b>TNK</b>	Para identificación inequívoca del número Bosch se debe tener a la vista la tarjeta de datos del vehículo. Los componentes enumerados en el producto deben coincidir con los de la tarjeta de datos.
<b>TW</b>	El producto montado se debe determinar en el vehículo o en el motor.
<b>U18</b>	Producción anterior
<b>U26</b>	Modelos posteriores
<b>UPE</b>	En caso de que se instale 0 928 400 527 para sustituir a 0 928 400 314, debe programarse la unidad de mando en un taller BMW.
<b>VAE</b>	Para vehículos con desintoxicación de gases de escape intensificada

<b>VGT</b>	Motor VGT
<b>VP4</b>	Atención: Observar el n° VW sobre la bomba. 059 130 106 A: pedir 0 470 506 046 o bien recambio 0 986 444 033. 059 130 106 D: pedir 0 470 506 002 o bien recambio 0 986 444 006.
<b>WAS</b>	Con separador de agua
<b>WAS</b>	Sin separador de agua
<b>WEG</b>	Para vehículos con dispositivo electrónico de inmovilización
<b>WEG</b>	Para vehículos sin inmovilizador electrónico
<b>WEI</b>	Caracterización de color: blanco
<b>WEK</b>	Para vehículos con inmovilizador electrónico y con acondicionador de aire

<b>WFS</b>	Unidad de mando con función integrada de inmovilizador electrónico
<b>WGT</b>	Motor WGT
<b>WOK</b>	Para vehículos con inmovilizador electrónico sin acondicionador de aire
<b>WW</b>	A elección
<b>WZT</b>	Para vehículos con dispositivo electrónico de inmovilización, liberación de conexión con llave de encendido (sistema Transponder)
<b>X10</b>	Para cilindro 1
<b>X56</b>	Para cilindro 2 - 6
<sup>1</sup>	Con detector de movimientos de aguja

	Turismo		Número de flecha
	Vehículo industrial		Combinación de portainyector
	Maquinaria agrícola o de construcción		Anillo de junta de culata/arandela calorífuga DHK
	Motor estacionario / motor industrial		Anillo de junta de conexión de aceite de fuga DHK
	Cilindrada en l		Anillo toroidal
	Potencia del motor en kW		Inyector Common Rail
	Tipo de motor		Bomba de alta presión Common Rail
	Número de cilindros		Bomba de inyección distribuidora VE y VR
	País de exportación		Medidor de masa de aire
	Fecha/periodo de fabricación		Unit Injection System UIS (Unidad bomba-inyector)
	Caso especial		Unit Pump System UPS
	Información / explicación		Unidad bomba-inyector (PDE)
	Número de referencia		Módulo de suministro Denoxtronic
	Referencia de intercambio		Referencia de página























<b>12V</b>	Tensão de bordo 12 Volt	<b>EU2</b>	Para veículos com norma relativa aos gases de escape Euro 2	<b>KZB</b>	Identificação: azul
<b>24V</b>	Tensão de bordo 24 Volt	<b>EU2</b>	Não para norma relativa aos gases de escape Euro 2	<b>KZE</b>	Identificação: amarelo
<b>3T5</b>	Para veículos com 3,5 t de peso máximo admissível	<b>EU3</b>	Para veículos com norma relativa aos gases de escape Euro 3	<b>KZG</b>	Identificação: verde
<b>4T5</b>	Para veículos com 4,5 t de peso máximo admissível	<b>EU3</b>	Não p/ veículos c/ norma relativa aos gases de escape Euro 3	<b>KZO</b>	Regiões frias
<b>AA</b>	Tração integral	<b>EU4</b>	Para veículos com norma relativa aos gases de escape Euro 4	<b>KZP</b>	Não adequado para regiões frias
<b>AA</b>	Sem tração integral	<b>EU4</b>	Não p/ veículos c/ norma relativa aos gases de escape Euro 4	<b>LH</b>	Para veículos com direção hidráulica
<b>ABS</b>	Para veículos com ABS	<b>EU5</b>	Para veículos com norma relativa aos gases de escape Euro 5	<b>LH</b>	Para veículos sem direção hidráulica
<b>ABS</b>	Para veículos sem ABS	<b>EU5</b>	Não p/ veículos c/ norma relativa aos gases de escape Euro 5	<b>LLE</b>	Para volante à esquerda
<b>AG</b>	Para veículos com caixa de câmbio automática	<b>EU6</b>	Para veículos com norma relativa aos gases de escape Euro 6	<b>LWG</b>	Para furgonetas
<b>AGF</b>	Para veículos com descontaminação de gases de escapamento	<b>EXW</b>	Substituição do eixo excêntrico apenas conjuntamente com a bomba de engrenagens 0 440 020 044	<b>MDR</b>	Com conta-giros
<b>AGF</b>	Para veículos sem descontaminação de gases de escapamento	<b>FBH</b>	Para funcionamento a grandes altitudes	<b>MDR</b>	Sem conta-giros
<b>AGR</b>	Recirculação dos gases de escapamento	<b>FD3</b>	Para a norma sobre emissões de gases de escapamento D3	<b>MEB</b>	Com sistema de injeção Bosch
<b>AGR</b>	Sem recirculação dos gases de escapamento	<b>FE2</b>	Para motores Euro 2/B	<b>MG5</b>	Para veículos com caixa de câmbio manual de 5 marchas
<b>ATW</b>	A troca do injetor não é possível no caso de conjuntos porta-injetor + injetor com sensor do movimento da agulha. Favor observar por ocasião do pedido. O produto instalado deve ser verificado no veículo ou no motor.	<b>FE2</b>	Não se destina a motores Euro 2/B	<b>MG6</b>	Para veículos com caixa de câmbio manual de 6 marchas
<b>BIO</b>	Para biocombustíveis	<b>FFK</b>	Para aquecimento dianteiro com sistema de ar condicionado	<b>MKO</b>	Para veículos com ar condicionado, sem direção hidráulica
<b>BIO</b>	Não para biocombustíveis	<b>FHE</b>	Para aquecimento	<b>MLK</b>	Para veículos com direção hidráulica e ar condicionado
<b>BKN</b>	Equipamento Bosch sem sistema de partida a frio	<b>FKR</b>	Para veículos com distância entre eixos curta	<b>MPR</b>	Para veículos com filtro de partículas de fuligem
<b>BO</b>	Bosch, somente como peça de reposição para equipamento Bosch	<b>FL5</b>	Para norma sobre emissões de gases de escapamento L5	<b>MPR</b>	Para veículos sem filtro de partículas de fuligem
<b>BOK</b>	Equipamento Bosch com sistema de partida a frio	<b>FLR</b>	Para veículos com distância entre eixos longa	<b>MRQ</b>	Para veículos com regulador das rotações máximas RQ
<b>BOW</b>	Bosch, somente como peça de reposição para equipamento Bosch, para veículos com imobilizador eletrônico	<b>FMA</b>	Para veículos sem airbag	<b>MVR</b>	Com variador de velocidade integrado
<b>BOW</b>	Bosch, somente como peça de reposição de equipamento Bosch, para veículos sem imobilizador eletrônico	<b>FMN</b>	Para veículos com tomada de força	<b>N01</b>	Para a norma sobre emissões de gases de escapamento ECE R15.04
<b>BS1</b>	Para aplicação BS 1	<b>FWT</b>	Para trocador de calor	<b>N03</b>	Para norma relativa aos gases de escape Euro 93 - CEE 19.5
<b>BS2</b>	Para aplicação BS 2	<b>GES</b>	Para veículos com sistema de regulagem da velocidade	<b>N05</b>	Para norma relativa aos gases de escape Euro 96, CEE 95, L3
<b>CAV</b>	Produto ou peça Bosch equivalente para CAV	<b>GES</b>	Para veículos sem sistema de regulagem da velocidade	<b>N07</b>	Para a norma sobre emissões de gases de escapamento US 87
<b>CSA</b>	O produto também pode ser pedido online em "www.partbob.com"	<b>GLA</b>	Nível de equipamento GL	<b>N09</b>	Para a norma sobre emissões de gases de escapamento US 84 LDT
<b>DBB</b>	Anel de vedação da câmara de combustão incluído	<b>GLX</b>	Nível de equipamento GLX	<b>N11</b>	Para a norma sobre emissões de gases de escapamento US 90 LDT
<b>DBJ</b>	Anel de vedação da câmara de combustão pré-montada no injetor	<b>GRF</b>	Versão básica	<b>N13</b>	Para norma relativa aos gases de escape Euro 96
<b>DBJ</b>	Anel de vedação da câmara de combustão não incluído no fornecimento	<b>GS</b>	Para veículos com caixa de câmbio manual	<b>N14</b>	Para a norma relativa aos gases de escape Euro 2000, CEE 2000
<b>DEP</b>	Para o sistema Delphi	<b>HAG</b>	Para veículos com caixa de câmbio semi-automática	<b>N25</b>	Para norma relativa aos gases de escape Euro 2005, EC 2005
<b>DKF</b>	Fabricação Zexel	<b>HEF</b>	Para veículos com desembaçador do pára-brisa	<b>N25</b>	Não para norma relativa aos gases de escape Euro 2005, EC 2005
<b>DRE</b>	Conexão prevista para conta-giros	<b>HEF</b>	Para veículos sem desembaçador do pára-brisa	<b>N39</b>	Para norma relativa aos gases de escape Euro 93 - CEE 19.5 e US 84 LDT
<b>E93</b>	Para norma sobre emissões de gases de escapamento CEE 93	<b>HL</b>	Correção da altitude	<b>NC8</b>	Para código de valores de gases de escapamento NC8
<b>E96</b>	Para norma sobre emissões de gases de escapamento CEE 96	<b>I1B</b>	Para injetor classe 1, com número de identificação 1 ou identificação da cor azul	<b>NC9</b>	Para código de valores de gases de escapamento NC9
<b>EC9</b>	Para norma sobre emissões de gases de escapamento CEE 99	<b>I2G</b>	Para injetor classe 2, com número de identificação 2 ou identificação da cor verde	<b>NOR</b>	Versão normal
<b>ECO</b>	Para nível de equipamento Ecomatic	<b>I3K</b>	Para injetor classe 3, com número de identificação 3	<b>NT5</b>	Para código de valores de gases de escapamento NT5
<b>EDC</b>	Regulagem diesel eletrônica	<b>KAT</b>	Para veículos com catalisador	<b>OBD</b>	Para veículos com diagnose On-Board (OBD)
<b>EE2</b>	Para norma sobre emissões de gases de escapamento CEE 2000	<b>KAF</b>	Para veículos sem catalisador	<b>OBD</b>	Para veículos sem diagnose On-Board (OBD)
<b>EEC</b>	Para norma sobre emissões de gases de escapamento CEE V	<b>KKA</b>	Com identificação Classe A	<b>OKN</b>	Sem identificação
<b>EFV</b>	Também como peça de reposição da peça anterior	<b>KKX</b>	Com identificação Classe X	<b>OLK</b>	Para veículos sem direção hidráulica e sem ar condicionado
<b>EFZ</b>	Reposição para produtos de terceiros, trocar por kits	<b>KKY</b>	Com identificação Classe Y	<b>OWK</b>	Para veículos sem imobilizador eletrônico, com ar condicionado
		<b>KKZ</b>	Com identificação Classe Z	<b>OWO</b>	Para veículos sem imobilizador eletrônico e sem ar condicionado
		<b>KL</b>	Para veículos com ar condicionado	<b>RAP</b>	Compatível com RME (éster metílico do óleo de colza)
		<b>KL</b>	Para veículos sem ar condicionado		
		<b>KOB</b>	Para perua		
		<b>KSE</b>	Para sistema de partida a frio		

<b>RAP</b>	Não compatível com RME (éster metílico do óleo de colza)
<b>RLE</b>	Para volante à direita
<b>RSA</b>	Identificação da cor, rosa
<b>SCJ</b>	Para veículos com SCR (Selective Catalytic Reduction)
<b>SGJ</b>	Para veículos sem SCR (Selective Catalytic Reduction)
<b>SFU</b>	Sensor de encaixe, individual
<b>SFZ</b>	Para veículos especiais
<b>SLX</b>	Para veículos com nível de equipamento SLX
<b>SSJ</b>	Para veículos com função de arranque/paragem
<b>SSJ</b>	Para veículos sem função de arranque/paragem
<b>THE</b>	Limitação comercial técnica, a peça de reposição pode apenas ser adquirida ao fabricante do veículo
<b>THI</b>	Após a substituição da unidade de comando da bomba ou da bomba injetora, o imobilizador tem de ser ativado numa oficina concessionada do fabricante do veículo.
<b>THS</b>	Após a montagem da bomba injetora, a unidade de comando tem de ser programada numa oficina da concessionária do fabricante do veículo.

<b>TNK</b>	A ficha de dados do veículo deve estar à disposição para a identificação inequívoca do número Bosch. Os componentes especificados para o produto devem coincidir com aqueles da ficha de dados.
<b>TW</b>	Produto montado tem que ser averiguado no veículo ou no motor.
<b>U18</b>	Produção antiga
<b>U26</b>	Modelos recentes
<b>UPE</b>	Se montar o componente 0 928 400 527 como substituto de 0 928 400 314, a unidade de comando tem de ser reprogramada em uma oficina da BMW.
<b>VAE</b>	Para veículos com descontaminação de gases de escapamento reforçada
<b>VGT</b>	Motor VGT
<b>VP4</b>	Atenção! Tomar em consideração o n.º VW. Encomendar 059 130 106 A : 0 470 506 046 ou substituto 0 986 444 033. Encomendar 059 130 106 D: 0 470 506 002 ou substituto 0 986 444 006.
<b>WAS</b>	Com separador de água
<b>WAS</b>	Sem separador de água

<b>WEG</b>	Para veículos com imobilizador eletrónico
<b>WEG</b>	Para veículos sem imobilizador eletrónico
<b>WEI</b>	Identificação da cor: branco
<b>WEK</b>	Para veículos com imobilizador eletrónico e ar condicionado
<b>WFS</b>	Unidade de comando com função de imobilizador integrada
<b>WGT</b>	Motor WGT
<b>WOK</b>	Para veículos com imobilizador eletrónico, sem ar condicionado
<b>WW</b>	Opcional
<b>WZT</b>	Para veículos com imobilizador eletrónico, liberação através da chave de ignição (sistema transponder)
<b>X10</b>	Para cilindro 1
<b>X56</b>	Para cilindros 2 - 6
<sup>1</sup>	Com sensor do movimento da agulha

	Veículo ligeiro
	Veículos pesados
	Máquinas agrícolas / de construção
	Motor estacionário / motor de montagem
	Cilindradas em l
	Potência do motor em kW
	Tipo de motor
	Número de cilindros
	País de exportação
	Data/Período de instalação
	Caso especial

	Informação / explicação
	Número de pedido
	Número de substituição
	Seta N
	Combinação de porta-injetor
	Anel de vedação cabeçote do motor/ arruela de isolamento térmico DHK
	Anel de vedação ligação de vazamento de óleo DHK
	O-ring
	Injector Common Rail
	Bomba de alta pressão Common Rail
	Bomba injetora distribuidora VE e VR

	Medidor de massa de ar
	Unit Injection System UIS (unidade injetor-bomba)
	Unit Injection System UPS (unidade bomba-injetor)
	Unidade bomba-injetor
	Módulo de alimentação Denoxtronic
	Referência do lado

<b>12V</b>	Elsystemspänning 12 Volt
<b>24V</b>	Elsystemspänning 24 Volt
<b>3T5</b>	För fordon med 3,5 t högsta tillåtna totalvikt
<b>4T5</b>	För fordon med 4,5 t högsta tillåtna totalvikt
<b>AA</b>	Fyrhjulsdrift
<b>AA</b>	Utan fyrhjulsdrift
<b>ABS</b>	För fordon med ABS
<b>ABS</b>	För fordon utan ABS
<b>AG</b>	För fordon med automatlåda
<b>AGF</b>	För fordon med avgasrening
<b>AGF</b>	För fordon utan avgasrening
<b>AGR</b>	Avgasåterföring
<b>AGR</b>	Ej avgasåterföring
<b>ATW</b>	I insprutare med NBF (nållyftssensor) är byte av spridare ej möjligt, beakta detta vid beställning. Inbyggt detalj måste konstateras på fordonet eller motorn.
<b>BIO</b>	För biobränsle
<b>BIO</b>	Ej för biobränsle
<b>BKN</b>	Bosch-utrustning utan kallstartsystem
<b>BO</b>	Bosch, endast som ersättning för Bosch-utrustning
<b>BOK</b>	Bosch-utrustning med kallstartanordning
<b>BOW</b>	Bosch, endast som ersättning för Bosch-utrustning, för fordon med immobiliser
<b>BOW</b>	Bosch, endast som ersättning för Bosch-utrustning, för fordon utan immobiliser
<b>BS1</b>	För BS 1 applikation
<b>BS2</b>	För BS 2 applikation
<b>CAV</b>	Monteringslik Bosch-produkt eller del för CAV
<b>CSA</b>	Produkt kan beställas online "www.partbob.com"
<b>DBB</b>	Förbränningsrumspackningsring bifogad
<b>DBJ</b>	förbränningsrumspackningsring på injektor förmonterad
<b>DBJ</b>	Tätningring för förbränningsrum medföljer inte
<b>DEP</b>	För Delphi system
<b>DKF</b>	Tillverkning ""Zexel""
<b>DRE</b>	Förberedd för varvtalsmätaranlutning
<b>E93</b>	För avgasstandard EEC 93
<b>E96</b>	För avgasstandard EEC 96
<b>EC9</b>	För avgasstandard EEC 99
<b>ECO</b>	För Ecomatic-utförande
<b>EDC</b>	Elektronisk dieselreglering
<b>EE2</b>	För avgasstandard EEC 2000
<b>EEC</b>	För avgasstandard EEC V
<b>EFV</b>	Även ersättning för föregångare
<b>EFZ</b>	Ersätter produkter från annan tillverkare, byts satsvis
<b>EU2</b>	För bilar med avgasstandard Euro 2
<b>EU2</b>	Ej för avgasstandard Euro 2
<b>EU3</b>	För bilar med avgasstandard Euro 3
<b>EU3</b>	Inte för bilar med avgasstandard EURO 3
<b>EU4</b>	För bilar med avgasstandard Euro 4
<b>EU4</b>	Inte för bilar med avgasstandard EURO 4
<b>EU5</b>	För bilar med avgasstandard Euro 5
<b>EU5</b>	Inte för bilar med avgasstandard EURO 5
<b>EU6</b>	För bilar med avgasstandard Euro 6
<b>EXW</b>	Byte av excenteraxel endast tillsammans med kugghjulspump 0 440 020 044
<b>FBH</b>	För drift på hög höjd
<b>FD3</b>	För avgasstandard D3
<b>FE2</b>	För Euro 2/B-motorer
<b>FE2</b>	Ej för Euro 2/B-motorer
<b>FFK</b>	För värme fram med AC-anläggning

<b>FHE</b>	För värme
<b>FKR</b>	För bil med kort hjulbas
<b>FL5</b>	För avgasstandard L5
<b>FLR</b>	För bil med lång hjulbas
<b>FMA</b>	För fordon utan krockkudde
<b>FMN</b>	För fordon med kraftuttag
<b>FWT</b>	För värmeväxlare
<b>GES</b>	För fordon med hastighetsreglersystem
<b>GES</b>	För fordon utan hastighetsreglersystem
<b>GLA</b>	GL-utförande
<b>GLX</b>	GLX-utförande
<b>GRF</b>	Grundutförande
<b>GS</b>	För fordon med manuell växellåda
<b>HAG</b>	För fordon med halvautomatisk växellåda
<b>HEF</b>	För bilar med uppvärmbär vindruta
<b>HEF</b>	För fordon utan uppvärmbär framruta
<b>HL</b>	Höjdkorrigerig
<b>I1B</b>	För injektor klass 1, med märksiffra 1 eller färgmärkning blå
<b>I2G</b>	För injektor klass 2, med märksiffra 2 eller färgmärkning grön
<b>I3K</b>	För injektor klass 3, med märksiffra 3
<b>KAT</b>	För katalysatorbilar
<b>KAT</b>	För bilar utan katalysator
<b>KKA</b>	Med märkning klass A
<b>KKX</b>	Med märkning klass X
<b>KKY</b>	Med märkning klass Y
<b>KKZ</b>	Med märkning klass Z
<b>KL</b>	För fordon med AC-anläggning
<b>KL</b>	För bilar utan AC-anläggning
<b>KOB</b>	För kombibil
<b>KSE</b>	Inbyggt kallstartanordning
<b>KZB</b>	Märkning: blå
<b>KZE</b>	Märkning: gul
<b>KZG</b>	Märkning: grön
<b>KZO</b>	Kalla zoner
<b>KZØ</b>	Inte för kalla zoner
<b>LH</b>	För fordon med servostyrning
<b>LH</b>	För fordon utan styrervo
<b>LLE</b>	För vänsterstyrda fordon
<b>LWG</b>	För distributionsbil
<b>MDR</b>	Med varvtalsmätare
<b>MØR</b>	Utan varvtalsmätare
<b>MEB</b>	Med Bosch insprutningssystem
<b>MG5</b>	För fordon med 5-växlad manuell växellåda
<b>MG6</b>	För fordon med 6-växlad manuell växellåda
<b>MKO</b>	För fordon med -anläggning, utan styrervo
<b>MLK</b>	För fordon med styrervo och AC-anläggning
<b>MPR</b>	För bilar med sotpartikelfilter
<b>MPR</b>	För bilar utan sotpartikelfilter
<b>MRQ</b>	För fordon med fullvarvsregulator RQ
<b>MVR</b>	Inbyggt ställregulator
<b>N01</b>	För avgasstandard ECE R15.04
<b>N03</b>	För avgasnorm Euro 93, CEE 19.5
<b>N05</b>	För avgasnorm Euro 96, CEE 95, L3
<b>N07</b>	För avgasstandard US 87
<b>N09</b>	För avgasstandard US 84 LDT
<b>N11</b>	För avgasstandard US 90 LDT
<b>N13</b>	För avgasstandard Euro 96
<b>N14</b>	För avgasnorm Euro 2000, CEE 2000
<b>N25</b>	För avgasnorm Euro 2005, EC 2005
<b>N25</b>	Ej för avgasnorm Euro 2005, EC 2005
<b>N39</b>	För avgasnorm Euro 93 - CEE 19.5 och US 84 LDT

<b>NC8</b>	För avgasvärdeskod NC8
<b>NC9</b>	För avgasvärdeskod NC9
<b>NOR</b>	Normalt utförande
<b>NT5</b>	För avgasvärdeskod NT5
<b>OBD</b>	För fordon med On-Board-diagnos (OBD)
<b>OBD</b>	För fordon utan On-Board-diagnos (OBD)
<b>OKN</b>	Utan märkning
<b>OLK</b>	För fordon utan styrhjälp och utan ABS
<b>OWK</b>	För fordon utan immobiliser, med AC-anläggning
<b>OWO</b>	För fordon utan immobiliser och utan AC-anläggning
<b>RAP</b>	RME-duglig (rapsoleetylester)
<b>RAP</b>	Ej RME-duglig (rapsoleetylester)
<b>RLE</b>	För högerstyrda fordon
<b>RSA</b>	Färgmärkning rosa
<b>SCJ</b>	För fordon med SCR (Selective Catalytic Reduction)
<b>SCJ</b>	För fordon utan SCR (Selective Catalytic Reduction)
<b>SFU</b>	Instickssensor, enkel
<b>SFZ</b>	För specialfordon
<b>SLX</b>	För fordon med SLX-utrustning
<b>SSJ</b>	För bilar med start-/stoppfunktion
<b>SSJ</b>	För bilar utan start-/stoppfunktion
<b>THE</b>	Teknisk handelsbegränsning, reserv kan endast beställas hos bitillverkaren
<b>THI</b>	Efter byte av pumpstyrdon eller insprutningspump måste startspärren aktiveras i en av bitillverkarens kontraktsverkstäder.
<b>THS</b>	Styranordningen måste, efter monteringen av insprutningspumpen, programmeras på en märkesverkstad.
<b>TNK</b>	För entydig identifiering av Bosch-numret måste bilens datakort föreligga. De vid produkten angivna komponenterna måste stämma överens med de på datakortet.
<b>TW</b>	Monterad produkt måste identifieras på bilen eller motorn.
<b>U18</b>	Tidig produktion
<b>U26</b>	Senare modeller
<b>UPE</b>	Om O 928 400 527 monteras som ersättning för O 928 400 314, så måste styrdonet programmeras om av en BMW-verkstad.
<b>VAE</b>	För fordon med utökad avgasrening
<b>VGT</b>	VGT motor
<b>VP4</b>	Observera! Beakta VW-nr på pumpen. 059 130 106 A : Beställ 0 470 506 046 eller ersättning 0 986 444 033. 059 130 106 D : Beställ 0 470 506 002 eller ersättning 0 986 444 006.
<b>WAS</b>	Med vattenavskiljare
<b>WAS</b>	Utan vattenavskiljare
<b>WEG</b>	För fordon med immobiliser
<b>WEG</b>	För fordon utan immobiliser
<b>WEI</b>	Färgmärkning: vit
<b>WEK</b>	För fordon med styrervo och AC-anläggning
<b>WFS</b>	Styrdon med integrerad immobiliser
<b>WGT</b>	WGT motor
<b>WOK</b>	För fordon med immobiliser, utan AC-anläggning
<b>WW</b>	Valfritt
<b>WZT</b>	För fordon med immobiliser, frigrivning över startnyckel (transpondersystem)
<b>X10</b>	För cylinder 1
<b>X56</b>	För cylinder 2 - 6
<b>1</b>	Med nållyftssensor

	Personbil		Common rail-högtryckspump
	Nyttfordon		Fördelarinsprutningspump VE och VR
	Jordbruks- eller entreprenadmaskin		Luftmassamätare
	Stationär motor/inbyggd motor		Unit Injection System UIS
	Slagvolym i l		Unit Pump System UPS
	Motoreffekt i kW		Enhetsinsprutare
	Motortyp		Denoxtronic-matarmodul
	Cylinderantal		Sidhänvisning
	Exportland		
	Datum/monteringstidpunkt		
	Speciellt fall		
	Information/förklaring		
	Artikelnummer		
	Utbytesnummer		
	Pil-N		
	Spridarhållarkombination		
	Tätningring cylinderlock/ värmeskyddsskiva DHK		
	Tätningring läckoljeanslutning DHK		
	O-ring		
	Common rail- injektor		



<b>12V</b>	Auton sähköjärjestelmä 12 V
<b>24V</b>	Auton sähköjärjestelmä 24 V
<b>3T5</b>	Mallit, joiden sallittu kokonaispaino on 3,5 t
<b>4T5</b>	Mallit, joiden sallittu kokonaispaino on 4,5 t
<b>AA</b>	Neliveto
<b>AA</b>	ilman nelivetoa
<b>ABS</b>	ABS-varusteiset mallit
<b>ABS</b>	Ajoneuvot ilman ABS-järjestelmää
<b>AG</b>	Automaattivaihteistolla varustetut ajoneuvot
<b>AGF</b>	Mallit, joissa pakokaasupuhdistus
<b>AGF</b>	Mallit ilman pakokaasujen puhdistusta
<b>AGR</b>	Pakokaasun kierrätys
<b>AGR</b>	ilman pakokaasun kierrätystä
<b>ATW</b>	Huomioi tilattaessa: Suutinta ei voi vaihtaa erikseen suutinpuidin-yhdistelmissä, joissa on neulan liiketunnistin (NBF). Tuotteen numero varmistettava ajoneuvosta / moottorista.
<b>BIO</b>	Biopolttoaineelle
<b>BIO</b>	Ei biopolttoaineelle
<b>BKN</b>	Bosch-varuste ilman kylmäkäynnistyslaitetta
<b>BO</b>	Bosch vain Bosch-varusteen korvaamiseksi
<b>BOK</b>	Bosch-varuste kylmäkäynnistyslaitteella
<b>BOW</b>	Bosch, vain Bosch-varusteen korvaamiseksi, ajonestolaitteella varustetut ajoneuvot.
<b>BOW</b>	Bosch, vain Bosch-varusteen korvaamiseksi, mallit ilman ajonestoa
<b>BS1</b>	BS 1 -sovellukseen
<b>BS2</b>	BS 2 -sovellukseen
<b>CAV</b>	CAV, vastaava Bosch-tuote tai varaosa
<b>CSA</b>	Tuote tilattavissa myös verkossa osoitteesta "www.partbob.com"
<b>DBB</b>	Palotilan tiivisterengas kuuluu toimitukseen
<b>DBJ</b>	Palotilan tiivisterengas esiasennettu injektoriin
<b>DBJ</b>	Palotilan tiivisterengas ei sisälly toimitukseen
<b>DEP</b>	Delphi-järjestelmää varten
<b>DKF</b>	Valmistaja Zexel
<b>DRE</b>	Varustettu kierroslukumittarin liitännällä
<b>E93</b>	EEC 93 -pakokaasustandardiin
<b>E96</b>	EEC 96 -pakokaasustandardiin
<b>EC9</b>	EEC 99 -pakokaasustandardiin
<b>ECO</b>	Ecomatic-malleihin
<b>EDC</b>	Elektroninen ohjaus, diesel
<b>EE2</b>	ETY 2000 -pakokaasustandardiin
<b>EEC</b>	EEC V -pakokaasustandardiin
<b>EFV</b>	Korvaa myös aikaisemman mallin
<b>EFZ</b>	Korvaa vierasmerkkisen tuotteen, vaihdettava sarjoittain
<b>EU2</b>	Malleihin, joissa pakokaasunormi Euro 2
<b>EU2</b>	Ei pakokaasunormiin EURO 2
<b>EU3</b>	Malleihin, joissa pakokaasunormi Euro 3
<b>EU3</b>	Ei malleihin, joissa pakokaasunormi Euro 3
<b>EU4</b>	Malleihin, joissa pakokaasunormi Euro 4
<b>EU4</b>	Ei autoihin, joissa Euro 4 pakokaasustandardi
<b>EU5</b>	Malleihin, joissa pakokaasunormi Euro 5
<b>EU6</b>	Ei malleihin, joissa pakokaasunormi Euro 5
<b>EU6</b>	Malleihin, joissa pakokaasunormi Euro 6
<b>EXW</b>	Epäkeskoakseli uusittava vain, josa varusteena hammashihnapumppu 0 440 020 044
<b>FBH</b>	Suunniteltu vuoristokäyttöön
<b>FD3</b>	pakokaasustandardiin D3
<b>FE2</b>	Euro 2/B-moottoreihin
<b>FE2</b>	Ei Euro 2/B-moottoreihin
<b>FFK</b>	Malleihin, joissa lämmityslaite edessä + ilmastointilaite
<b>FHE</b>	lämmityslaitteeseen
<b>FKR</b>	Malleihin, joissa lyhyt akseliväli
<b>FL5</b>	pakokaasustandardi L5
<b>FLR</b>	Mallit, joissa pitkä akseliväli
<b>FMA</b>	Mallit ilman turvatyynyä
<b>FMN</b>	Voiman ulosotolla varustetut ajoneuvot
<b>FMT</b>	lämmönvaihtimeen
<b>GES</b>	Malleihin, joissa vakionopeussäädin
<b>GES</b>	Mallit ilman ajonopeuden säätöä
<b>GLA</b>	GL-malli
<b>GLX</b>	GLX-malli
<b>GRF</b>	perusmalli
<b>GS</b>	Mekaanisella vaihteistolla varust. mallit
<b>HAG</b>	Malleihin, joissa puoliautomaattivaihteisto
<b>HEF</b>	Malleihin, joissa lämmitettävä tuulilasi
<b>HEF</b>	Mallit ilman tuulilasin lämmitystä
<b>HL</b>	korkeustunnistin
<b>I1B</b>	Injektoriluokka 1, tunnusluku 1 tai sininen tunnusväri
<b>I2G</b>	Injektoriluokka 2, tunnusluku 2 tai vihreä tunnusväri
<b>I3K</b>	Injektoriluokka 3, tunnusluku 3
<b>KAT</b>	Katalysaattorilla varustetut mallit
<b>KAT</b>	Mallit ilman katalysaattoria
<b>KKA</b>	+ tunnus A-luokka
<b>KKX</b>	+ tunnus X-luokka
<b>KKY</b>	+ tunnus Y-luokka
<b>KKZ</b>	+ tunnus Z-luokka
<b>KL</b>	Malleihin, joissa ilmastointilaite
<b>KL</b>	Mallit ilman ilmastointilaitetta
<b>KOB</b>	farmari
<b>KSE</b>	varust. kylmäkäynnistyslaite
<b>KZB</b>	Väritunnus: sininen
<b>KZE</b>	Väritunnus: keltainen
<b>KZG</b>	Väritunnus: vihreä
<b>KZO</b>	kylmä ilmastovyöhyke
<b>KZO</b>	Ei kylmiin ilmastovyöhykkeisiin
<b>LH</b>	Ohjaustehostimella varustet mallit
<b>LH</b>	Mallit ilman ohjaustehostinta
<b>LLE</b>	Vasemmalta ohjattavaan malliin
<b>LWG</b>	jakeluajoneuvoihin
<b>MDR</b>	+ pyörintänopeusmittari
<b>MDR</b>	ei kierroslukumittaria
<b>MEB</b>	varust. Bosch-ruiskutusjärjestelmä
<b>MG5</b>	Mallit, joissa 5-vaiht. mekaaninen vaihteisto
<b>MG6</b>	Mallit, joissa 6-vaiht. mekaaninen vaihteisto
<b>MKO</b>	Mallit, joissa autom. ilmastointi, ei ohjaustehostinta
<b>MLK</b>	Malleihin, joissa ohjaustehostin ja ilmastointi
<b>MPR</b>	Autot, joissa on nokihiiukkassuodatin
<b>MPR</b>	Autot, joissa ei ole nokihiiukkassuodatinta
<b>MRQ</b>	Malleihin, joissa RQ-ajanopeussäädin
<b>MVR</b>	varust. siirtosäädin
<b>N01</b>	Pakokaasustandardi ECE R15.04
<b>N03</b>	Pakokaasunormi EURO 93, CEE 19.5
<b>N05</b>	Pakokaasunormi EURO 96, CEE 95, L3
<b>N07</b>	Pakokaasustandardi US 87
<b>N09</b>	Pakokaasustandardi US 84 LDT
<b>N11</b>	Pakokaasustandardi US 90 LDT
<b>N13</b>	Pakokaasunormi EURO 96
<b>N14</b>	Pakokaasunormi EURO 2000, CEE 2000
<b>N25</b>	Pakokaasunormi EURO 2005, EC 2005
<b>N26</b>	Ei pakokaasunormiin EURO 2005, EC 2005
<b>N39</b>	Pakokaasunormi Euro 93 - CEE 19.5 ja US 84 LDT
<b>NC8</b>	Pakokaasukoodi NC8
<b>NC9</b>	Pakokaasukoodi NC9
<b>NOR</b>	Normaali versio
<b>NT5</b>	NT5-pakokaasukoodi
<b>OBD</b>	Autoja varten, joissa on On-Board-diagnoosi (OBD)
<b>OBD</b>	Autoja varten, joissa ei ole On-Board-diagnoosia (OBD)
<b>OKN</b>	Ei tunnusmerkintää
<b>OLK</b>	Mallit ilman ohjaustehostinta ja ilman ilmastointia
<b>OWK</b>	Mallit ilman ajonestoa, + ilmastointilaite
<b>OWO</b>	Mallit ilman ajonestoa ja ilman ilmastointia
<b>RAP</b>	RME-sopiva (rapsiöljymetyyliesteri)
<b>RAP</b>	Ei RME-sopiva (rapsiöljymetyyliesteri)
<b>RLE</b>	oikealta ohjattava
<b>RSA</b>	Tunnusväri roosa
<b>SCJ</b>	Ajoneuvomalleihin, joissa on selektiivinen SCR-katalysaattori (Selective Catalytic Reduction)
<b>SCJ</b>	Ajoneuvomalleihin ilman selektiivistä SCR-katalysaattoria (Selective Catalytic Reduction)
<b>SFU</b>	Pikaliitettävä tunnistin, yksittäinen
<b>SFZ</b>	Erikisajoneuvoihin
<b>SLX</b>	Malleihin, joissa SLX-varustus
<b>SSJ</b>	Ajoneuvoihin, joissa on Start-/Stop-toiminto
<b>SSJ</b>	Ajoneuvoihin ilman Start-/Stop-toimintoa
<b>THE</b>	Tekninen kaupparajoitus, vaihto-osan saa vain auton valmistajalta
<b>THI</b>	Jos ruiskutuspumppu tai sen ohjainlaite on jouduttu uusimaan, on ajonestolaite annettava aktivoida ajoneuvon valmistajan sopimuskorjaamossa.
<b>THS</b>	Ruiskutuspumpan asennuksen päätteeksi ohjainlaite on annettava ohjelmoida ajoneuvon valmistajan sopimuskorjaamossa.
<b>TNK</b>	Bosch-numero on voitava tunnistaa yksiselitteisesti ajoneuvon papereista. Tuotteeseen kuuluvien komponenttien on oltava samat kuin datakortissa annetut osat.
<b>TW</b>	Asennettu tuote on määritettävä ajoneuvoa tai moottoria varten.
<b>U18</b>	Varhainen tuotanto
<b>U26</b>	Myöhäisemmät mallit
<b>UPE</b>	Jos 0 928 400 527 asennetaan 0 928 400 314 : n tilalle, ohjainlaite on koodattava BMW-korjaamossa.
<b>VAE</b>	Mallit, joissa tehostettu pakokaasujen puhdistus
<b>VGT</b>	VGT-moottori
<b>VP4</b>	Huomio! Ota huomioon pumpun VW-nro. 059 130 106 A: tilaa 0 470 506 046 tai vaihto-osa 0 986 444 033. 059 130 106 D: tilaa 0 470 506 002 tai vaihto-osa 0 986 444 006.
<b>WAS</b>	+ vedenerotin
<b>WAS</b>	Ei vedenerotinta
<b>WEG</b>	ajonestolaitteella varustetut ajoneuvot
<b>WEG</b>	Mallit ilman ajonestolaitetta
<b>WEI</b>	Värimerkintä: valkoinen
<b>WEK</b>	Malleihin, joissa ajonesto ja ilmastointi
<b>WFS</b>	Ohjainlaite + yhdistetty ajonestotoiminto
<b>WGT</b>	WGT-moottori
<b>WOK</b>	Mallit, joissa ajonesto, ei ilmastointia
<b>WW</b>	Optio
<b>WZT</b>	Ajonestolaitteella varustetut ajoneuvot, koodattu virta-avain (transponder)
<b>X10</b>	Sylinteri 1
<b>X56</b>	Sylinterit 2 - 6
<b>1</b>	+ neulan liiketunnistin

	HA		Common Rail -korkeapainepumppu
	HYA		VE- ja VR-jakajaruiskutuspumppu
	Maatalouskone tai työkone		Ilmamassanmittari
	Paikallismoottori / asennusmoottori		Unit Injection System UIS (pumppusuutin-yksikkö)
	Iskutilavuus l //ccm		Unit Pump System UPS
	Moottorin teho kW		Pumppusuutin-yksikkö (PDE)
	Moottorityyppi Typ		Denoxtronic-syöttömoduuli
	Sylinteriluku Zyl.		Sivuviite
	Vientimaa		
	Päiväys/asennusaikaväli		
	Erytystapaus		
	Informaatio / selitys		
	Tilausnumero		
	Vaihtolaitenumero		
	Nuoli-N		
	Suutinpidinkokonaisuus		
	Tiivisterengas, sylinterinkansi/ lämmönsuojalevy DHK		
	Tiivisterengas, vuotoöljyliitännä DHK		
	O-rengas		
	Common Rail -injektor		





























<b>12V</b>	Napięcie pokładowe 12 V	<b>EU4</b>	Dla pojazdów z normą emisji spalin Euro 4	<b>MLK</b>	Dla pojazdów ze wspomaganie kierownicy i klimatyzacją
<b>24V</b>	Napięcie pokładowe 24 V	<b>EU4</b>	Nie dla pojazdów z normą emisji spalin Euro 4	<b>MPR</b>	Dla pojazdów z filtrem cząstek sadzy
<b>3T5</b>	Dla pojazdów o dopuszczalnej masie całkowitej 3,5 t	<b>EU5</b>	Dla pojazdów z normą emisji spalin Euro 5	<b>MPR</b>	Dla pojazdów bez filtra sadzy
<b>4T5</b>	Dla pojazdów o dopuszczalnej masie całkowitej 4,5 t	<b>EU5</b>	Nie dla pojazdów spełniających wymagania normy spalin EURO 5	<b>MRQ</b>	Dla pojazdów z wysokozakresowym regulatorem prędkości obrotowej RQ
<b>AA</b>	Napęd na wszystkie koła	<b>EU6</b>	Dla pojazdów z normą emisji spalin Euro 6	<b>MVR</b>	Regulator, wmontowany
<b>AA</b>	Bez napędu na wszystkie koła	<b>EXW</b>	Wymiana wałka mimośrodowego tylko w połączeniu z pompą zębatą 0 440 020 044	<b>N01</b>	Dla normy emisji spalin ECE R15.04
<b>ABS</b>	Do pojazdów z ABS	<b>FBH</b>	Do pracy na dużych wysokościach	<b>N03</b>	Dla normy emisji spalin Euro 93 - CEE 19.5
<b>ABS</b>	Dla pojazdów bez ABS	<b>FD3</b>	Dla normy emisji spalin D3	<b>N05</b>	Dla normy emisji spalin Euro 96, CEE 95, L3
<b>AG</b>	Do pojazdów z automatyczną skrzynią biegów	<b>FE2</b>	Dla silników Euro 2/B	<b>N07</b>	Dla normy emisji spalin US 87
<b>AGF</b>	Dla pojazdów z oczyszczaniem spalin	<b>FE2</b>	Nie dla silników Euro 2/B	<b>N09</b>	Dla normy emisji spalin US 84 LDT
<b>AGF</b>	Dla pojazdów bez oczyszczania spalin	<b>FFK</b>	Do ogrzewania przedniego z klimatyzacją	<b>N11</b>	Dla normy emisji spalin US 90 LDT
<b>AGR</b>	Układ recyrkulacji spalin	<b>FHE</b>	Do ogrzewania	<b>N13</b>	Dla normy emisji spalin Euro 96
<b>AGR</b>	Bez układu recyrkulacji spalin	<b>FKR</b>	Dla pojazdów z krótkim rozstawem kół	<b>N14</b>	Dla normy emisji spalin Euro 2000, CEE 2000
<b>ATW</b>	Przy zamawianiu pamiętać: w przypadku kombinacji korpusu wtryskiwaczy z NBF (czujnikiem ruchu iglicy) wymiana wtryskiwaczy nie jest możliwa. Zamontowana część musi zostać określona na podstawie pojazdu lub silnika.	<b>FL5</b>	Dla normy emisji spalin L5	<b>N25</b>	Dla normy emisji spalin Euro 2005, EC 2005
<b>BIO</b>	Dla biopaliwa	<b>FLR</b>	Dla pojazdów z długim rozstawem kół	<b>N25</b>	Nie dla normy spalin 2005, EC 2005
<b>BIO</b>	Nie dla biopaliwa	<b>FMA</b>	Dla pojazdów bez poduszki powietrznej	<b>N39</b>	Dla normy emisji spalin Euro 93 - CEE 19.5 i US 84 LDT
<b>BKN</b>	Wyposażenie firmy Bosch bez instalacji do zimnego rozruchu	<b>FMN</b>	Dla pojazdów z napędem dodatkowym	<b>NC8</b>	Dla kodu emisji spalin NC8
<b>BO</b>	Bosch, jedynie jako część zamienna do wyposażenia Boscha	<b>FMT</b>	Do wymiennika ciepła	<b>NC9</b>	Dla kodu emisji spalin NC9
<b>BOK</b>	Wyposażenie Boscha z układem rozruchu zimnego silnika	<b>GES</b>	Do pojazdów z urządzeniem regulującym prędkość	<b>NOR</b>	Wykonanie normalne
<b>BOW</b>	Bosch, jedynie jako część zamienna do wyposażenia Boscha, dla pojazdów z immobilizery.	<b>GES</b>	Dla pojazdów bez regulatora prędkości	<b>NT5</b>	Dla kodu emisji spalin NT5
<b>BOW</b>	Bosch, jedynie jako część zamienna do wyposażenia Boscha, dla pojazdów bez immobilizera.	<b>GLA</b>	Model GL	<b>OBD</b>	Dla pojazdów z diagnostyką On-Board (OBD)
<b>BS1</b>	Do aplikacji BS 1	<b>GLX</b>	Wersja GLX	<b>OBD</b>	Dla pojazdów bez diagnostyki On-Board (OBD)
<b>BS2</b>	Do aplikacji BS 2	<b>GRF</b>	Wykonanie podstawowe	<b>OKN</b>	Bez oznaczenia
<b>CAV</b>	Produkt firmy Bosch identyczny pod względem montażu lub części do CAV	<b>GS</b>	Do pojazdów z ręczną skrzynią biegów	<b>OLK</b>	Dla pojazdów bez wspomaganie układu kierowniczego i bez klimatyzacji
<b>CSA</b>	Wyrób można zamówić również online na stronie "www.partbob.com"	<b>HAG</b>	Dla pojazdów z półautomatyczną skrzynią biegów	<b>OWK</b>	Dla pojazdów bez immobilizera, z klimatyzacją
<b>DBB</b>	Pierścień uszczelniający komorę spalania znajduje się w zestawie	<b>HEF</b>	Dla pojazdów z ogrzewaną szybą przednią	<b>OWO</b>	Dla pojazdów bez immobilizera i bez klimatyzacji
<b>DBJ</b>	Pierścień uszczelniający komorę spalania przy wtryskiwaczu, wstępnie zmontowany	<b>HEF</b>	Dla pojazdów z ogrzewanej szyby przedniej	<b>RAP</b>	Przygotowany do jazdy na RME (ester metylowy oleju rzepakowego)
<b>DBJ</b>	Dostawa nie obejmuje pierścienia uszczelniającego komory spalania	<b>HL</b>	Korekta wysokości	<b>RAP</b>	Nie przygotowany do jazdy na RME (ester metylowy oleju rzepakowego)
<b>DEP</b>	Do systemu Delphi	<b>I1B</b>	Dla iniektora kl. 1, z kodem liczbowym 1 lub oznaczeniem kolorem niebieskim	<b>RLE</b>	Dla pojazdów z kierownicą z prawej strony
<b>DKF</b>	Produkcja Zexel	<b>I2G</b>	Dla iniektora kl. 2, z kodem liczbowym 2 lub oznaczeniem kolorem zielonym	<b>RSA</b>	Oznaczenie w kolorze różowym
<b>DRE</b>	Przewidziane przyłącze obrotomierza	<b>I3K</b>	Dla iniektora kl. 3, z liczbą znamionową 3	<b>SCJ</b>	Do pojazdów z SCR (Selective Catalytic Reduction)
<b>E93</b>	Dla normy emisji spalin EEC 93	<b>KAT</b>	Dla pojazdów z katalizatorem	<b>SGJ</b>	Do pojazdów bez SCR (Selective Catalytic Reduction)
<b>E96</b>	Dla normy emisji spalin EEC 96	<b>KAT</b>	Dla pojazdów bez katalizatora	<b>SFU</b>	Czujnik wtykowy, pojedynczy
<b>EC9</b>	Dla normy emisji spalin EEC 99	<b>KKA</b>	Z oznakowaniem klasy A	<b>SFZ</b>	Dla pojazdów specjalnych
<b>ECO</b>	Do modelu Ecomatic	<b>KKX</b>	Z oznakowaniem klasy X	<b>SLX</b>	Dla pojazdów z wyposażeniem SLX
<b>EDC</b>	Elektroniczna regulacja silnika wysokoprężnego	<b>KKY</b>	Z oznakowaniem klasy Y	<b>SSJ</b>	Dla pojazdów z funkcją start/stop
<b>EE2</b>	Dla normy emisji spalin EEC 2000	<b>KKZ</b>	Z oznakowaniem klasy Z	<b>SSJ</b>	Dla pojazdów bez funkcji start/stop
<b>EEC</b>	Dla normy emisji spalin EEC V	<b>KL</b>	Dla pojazdów z klimatyzacją	<b>THE</b>	techniczne ograniczenie obrotu handlowego, część zamienną można nabyć tylko u producenta pojazdu
<b>EFV</b>	Części zamienne również dla modelu poprzedniego	<b>KL</b>	Dla pojazdów bez klimatyzacji	<b>THI</b>	Po wymianie sterownika pompy albo pompy wtryskowej immobilizer musi być uaktywniany w autoryzowanym warsztacie producenta.
<b>EFZ</b>	Zamiennik dla wyrobów obcej firmy, wymienić cały zespół	<b>KOB</b>	Do samochodów kombi	<b>THS</b>	Sterownik po montażu pompy wtryskowej musi zostać zaprogramowany w autoryzowanym warsztacie producenta pojazdu.
<b>EU2</b>	Dla pojazdów z normą emisji spalin Euro 2	<b>KSE</b>	Układ rozruchu zimnego silnika wbudowany	<b>TNK</b>	W celu jednoznacznej identyfikacji numeru Boscha należy przedłożyć kartę danych pojazdu. Elementy towarzyszące wyrobom muszą być zgodne z wymienionymi w karcie danych.
<b>EU2</b>	Nie dla normy emisji spalin Euro 2	<b>KZB</b>	Oznaczenie: kolor niebieski	<b>TW</b>	Zamontowany wyrób musi być zidentyfikowany w pojeździe lub silniku.
<b>EU3</b>	Dla pojazdów z normą emisji spalin Euro 3	<b>KZE</b>	Oznaczenie: kolor żółty	<b>U18</b>	Wcześniejsza produkcja
<b>EU3</b>	Nie dla pojazdów spełniających wymagania normy spalin EURO 3	<b>KZG</b>	Oznaczenie: kolor zielony	<b>U26</b>	Późniejsze modele
		<b>KZO</b>	Zimne strefy	<b>UPE</b>	W razie montażu 0 928 400 527 zamiast 0 928 400 314 konieczna jest reprogramacja sterownika przez serwis BMW.
		<b>LH</b>	Dla pojazdów ze wspomaganie kierownicy		
		<b>LH</b>	Dla pojazdów bez wspomaganie kierownicy		
		<b>LLE</b>	Dla pojazdów z kierownicą z lewej strony		
		<b>LWG</b>	Dla samochodu dostawczego		
		<b>MDR</b>	Z obrotomierzem		
		<b>MDR</b>	Bez obrotomierza		
		<b>MEB</b>	Z układem wtryskowym firmy Bosch		
		<b>MG5</b>	Do pojazdów z 5-cio biegową ręczną skrzynią biegów		
		<b>MG6</b>	Do pojazdów z 6-cio biegową ręczną skrzynią biegów		
		<b>MKO</b>	Dla pojazdów z klimatyzacją, bez wspomaganie układu kierowniczego		



<b>VAE</b>	Dla pojazdów z zintensyfikowanym systemem oczyszczania spalin z substancji szkodliwych
<b>VGT</b>	Silnik VGT
<b>VP4</b>	Uwaga! Zwracać uwagę na nr VW, znajdujący się na pompie. 059 130 106 A: zamówić 0 470 506 046 albo zamienną 0 986 444 033. 059 130 106 D: zamówić 0 470 506 002 albo zamienną 0 986 444 006.

<b>WAS</b>	Z oddzielaczem wody
<b>WAS</b>	Bez oddzielacza wody
<b>WEG</b>	Dla pojazdów z immobilizerem
<b>WEG</b>	Dla pojazdów bez immobilizera
<b>WEI</b>	Oznaczenie kolorem: biały
<b>WEK</b>	Dla pojazdów z immobilizerem i klimatyzacją
<b>WFS</b>	Przyrząd sterowniczy ze zintegrowaną funkcją immobilizera

<b>WGT</b>	Silnik WGT
<b>WOK</b>	Dla pojazdów z immobilajzerem , bez klimatyzacji
<b>WW</b>	Do wyboru
<b>WZT</b>	Dla pojazdów z immobilajzerem, odblokowanie przez klucz zapłonowy (system Transponder)
<b>X10</b>	Dla cylindra 1
<b>X56</b>	Dla cylindrów 2 - 6
<sup>1</sup>	Z czujnikiem położenia iglicy

	Samochody osobowe		Uszczelka głowicy cylindrów/podkładka termoizolacyjna DHK
	Samochody użytkowe		Uszczelka przyłącza oleju odciekowego DHK
	Maszyny rolnicze / budowlane		O-ring
	Silnik stacjonarny / silnik do wbudowania		Wtryskiwacz Common Rail
	Pojemność silnika w litrach		Pompa wysokiego ciśnienia Common Rail
	Moc silnika w kW		Pompa wtryskowa rozdzielaczowa VE i VR
	Typ silnika		Przepływomierz masowy powietrza
	Liczba cylindrów		System Pompowtryskiwaczy (Unit Injection System)
	Kraj eksportu		Unit Pump System UPS
	Data produkcji		Pompowtryskiwacz (PDE)
	Informacje dodatkowe		Moduł tłoczący Denoxtronic
	Informacja / objaśnienie		Odesłanie do strony
	Nr katalogowy		
	Nr wymienianej części		
	Strzałka N		
	Wtryskiwacz		



<b>12V</b>	Напряжение бортовой сети 12 Вольт
<b>24V</b>	Напряжение бортовой сети 24 Вольт
<b>3T5</b>	Для автомобилей с допустимой полной массой 3,5 т
<b>4T5</b>	Для автомобилей с допустимой полной массой 4,5 т
<b>AA</b>	Привод на все колеса
<b>AA</b>	без привода на все колеса
<b>ABS</b>	для автомобилей с антиблокировочным устройством
<b>ABS</b>	для автомобилей без антиблокировочного устройства
<b>AG</b>	для автомобилей с автоматической коробкой скоростей
<b>AGF</b>	Для автомобилей со сниженной токсичностью ОГ
<b>AGF</b>	Не для автомобилей со сниженным уровнем ОГ
<b>AGR</b>	Рециркуляция отработавших газов
<b>AGR</b>	без рециркуляции ОГ
<b>ATW</b>	При заказе обратить внимание: комбинации корпуса форсунки с датчиком движения иглы (NBF) замена форсунки невозможна. Встроенное изделие должно быть определено в автомобиле или моторе.
<b>BIO</b>	Для биологического топлива
<b>ВЮ</b>	Не для биологического топлива
<b>BKN</b>	Оснащение Bosch без устройства для пуска холодного двигателя
<b>BO</b>	Bosch, только в качестве замены оснащения фирмы Bosch
<b>BOK</b>	Оборудование фирмы Bosch с установкой для пуска холодного двигателя
<b>BOW</b>	Bosch, только в качестве замены оснащения фирмы Bosch, для автомобилей с противоугонным устройством.
<b>BOW</b>	Bosch, только в качестве замены оснащения фирмы Bosch, для автомобилей без противоугонного устройства.
<b>BS1</b>	Для приложений BS 1
<b>BS2</b>	Для приложений BS 2
<b>CAV</b>	взаимозаменяемый продукт фирмы Bosch или деталь для фирмы CAV
<b>CSA</b>	Изделие можно также заказать он-лайн "www.partbob.com"
<b>DBB</b>	Уплотнительное кольцо камеры сгорания прилагается
<b>DBJ</b>	Уплотнительное кольцо камеры сгорания, предварительно смонтированное на инжекторе
<b>DBJ</b>	Уплотнительное кольцо камеры сгорания не входит в комплект поставки
<b>DEP</b>	Для системы Delphi
<b>DKF</b>	производство Цексель
<b>DRE</b>	Предусмотрено подключение измерителя числа оборотов
<b>E93</b>	Для нормы токсичности ОГ EEC 93
<b>E96</b>	Для нормы токсичности ОГ EEC 96
<b>EC9</b>	Для нормы токсичности ОГ EEC 99
<b>ECO</b>	Для исполнения Ecomatic
<b>EDC</b>	электронное управление дизелем
<b>EE2</b>	Для стандарта по отработавшим газам EEC 2000
<b>EEC</b>	Для нормы токсичности ОГ EEC V
<b>EFV</b>	Также замена для предшественника
<b>EFZ</b>	замена изделий других производителей, заменять частями
<b>EU2</b>	Для автомобилей с нормой токсичности ОГ Euro 2
<b>EU2</b>	Не для нормы токсичности ОГ Euro 2
<b>EU3</b>	Для автомобилей с нормой токсичности ОГ Euro 3
<b>EU3</b>	Не для автомобилей с нормой токсичности ОГ Euro 3
<b>EU4</b>	Для автомобилей с нормой токсичности ОГ Euro 4
<b>EU4</b>	Не для а/м с нормами токсичности ОГ Euro 4
<b>EU5</b>	Для автомобилей с нормой токсичности ОГ Euro 5
<b>EU5</b>	Не для автомобилей с нормой токсичности ОГ Euro 5
<b>EU6</b>	Для автомобилей с нормой токсичности ОГ Euro 6
<b>EXW</b>	Замена эксцентрикового вала только вместе с шестеренным насосом 0 440 020 044
<b>FBH</b>	Для эксплуатации на больших высотах
<b>FD3</b>	Для нормы выпуска ОГ D3
<b>FE2</b>	Для двигателей Euro 2/B
<b>FE2</b>	Не для двигателей Euro 2/B
<b>FFK</b>	Для переднего отопления с кондиционером
<b>FHE</b>	для отопления
<b>FKR</b>	для автомобилей с короткой базой
<b>FL5</b>	Для нормы токсичности ОГ L5
<b>FLR</b>	для автомобилей с длинной базой
<b>FMA</b>	Для транспортных средств без надувной подушки безопасности
<b>FMN</b>	для автомобилей с механизмом отбора мощности
<b>FWT</b>	Для теплообменника
<b>GES</b>	для автомобилей с устройством регулятора скорости
<b>GES</b>	для автомобилей без устройства регулятора скорости
<b>GLA</b>	исполнение GL
<b>GLX</b>	исполнение GLX
<b>GRF</b>	базовое исполнение
<b>GS</b>	для автомобилей с коробкой передач с ручным управлением
<b>HAG</b>	Для автомобилей с полуавтоматической коробкой передач
<b>HEF</b>	Для автомоб.с обогреваемым лобовым стеклом
<b>HEF</b>	Для автомобилей без подогрева ветрового стекла
<b>HL</b>	корректор высоты
<b>I1B</b>	Для инжектора класса 1, с кодом 1 или цветовой маркировкой, синей
<b>I2G</b>	Для инжектора класса 2, с кодом 2 или цветовой маркировкой, зеленой
<b>I3K</b>	Для инжектора класса 3, с обозначением 3
<b>KAT</b>	для автомобилей с катализатором
<b>KAT</b>	для автомобилей без катализатора
<b>KKA</b>	С маркировкой класса A
<b>KKX</b>	С обозначением класса X
<b>KKY</b>	С обозначением класса Y
<b>KKZ</b>	С обозначением класса Z
<b>KL</b>	Для автомобилей с кондиционером
<b>KL</b>	для автомобилей без кондиционера
<b>KOB</b>	для автомобиля комби
<b>KSE</b>	приспособление холодного запуска, встроенное
<b>KZB</b>	номерной знак: синий
<b>KZE</b>	Номерной знак : желтый
<b>KZG</b>	номерной знак: зеленый
<b>KZO</b>	Холодные зоны
<b>KZO</b>	Не для холодных зон
<b>LH</b>	Для автомобилей с усилителем рулевого управления
<b>LH</b>	Для автомобилей без усилителя рулевого управления
<b>LLE</b>	для автомобилей с левосторонним расположением рулевого колеса
<b>LWG</b>	для автомобилей для перевозки мелкопартийных грузов
<b>MDR</b>	С тахометром
<b>MDR</b>	Без тахометра
<b>MEB</b>	с системой впрыскивания Bosch
<b>MG5</b>	для автомобилей с коробкой передач с ручным управлением, 5-ти скоростной
<b>MG6</b>	для автомобилей с коробкой передач с ручным управлением, 6 -ти скоростной
<b>MKO</b>	Для транспортных средств с климатической установкой, без усилителя рулевого привода
<b>MLK</b>	для автомобилей с усилителем рулевого привода и кондиционером
<b>MPR</b>	Для автомобилей с сажевым пылевым фильтром
<b>MPR</b>	Для автомобилей без сажевого пылевого фильтра
<b>MRQ</b>	Для автомобилей с ограничителем максимальной частоты вращения RQ
<b>MVR</b>	всерезимный регулятор частоты вращения, встроенный
<b>N01</b>	Для нормы ОГ ECE R15.04
<b>N03</b>	Для нормы токсичности ОГ Euro 93 - CEE 19.5
<b>N05</b>	Для нормы токсичности ОГ Euro 96, CEE 95, L3
<b>N07</b>	Для нормы ОГ US 87
<b>N09</b>	Для нормы ОГ US 84 LDT
<b>N11</b>	Для нормы ОГ US 90 LDT
<b>N13</b>	Для нормы токсичности ОГ Euro 96
<b>N14</b>	Для нормы токсичности ОГ Euro 2000, CEE 2000
<b>N25</b>	Для нормы токсичности ОГ Euro 2005, EC 2005
<b>N25</b>	Не для нормы токсичности ОГ Euro 2005, EC 2005
<b>N39</b>	Для нормы токсичности ОГ Euro 93 - CEE 19.5 и US 84 LDT
<b>NC8</b>	Для кода значения ОГ NC8
<b>NC9</b>	Для кода показателей состава ОГ NC9
<b>NOR</b>	Обычное исполнение
<b>NT5</b>	Для кода значения ОГ NT5
<b>OBD</b>	Для автомобилей с бортовой диагностикой (OBD)
<b>OBD</b>	Для автомобилей без бортовой диагностики (OBD)
<b>OKN</b>	Без обозначения
<b>OLK</b>	без усилителя рулевого привода и кондиционера
<b>OWK</b>	для автомобилей без противоугонного устройства, с кондиционером
<b>OWO</b>	Для транспортных средств без противоугонной функции и без климатической установки
<b>RAP</b>	С возможностью работы на RME (сложный метиловый эфир рапсового масла)
<b>RAP</b>	Без возможности работы на RME (сложный метиловый эфир рапсового масла)
<b>RLE</b>	для автомобилей с правосторонним расположением рулевого колеса

<b>RSA</b>	Цветовая маркировка: розовая
<b>SCJ</b>	Для а/м с SCR (Selective Catalytic Reduction)
<b>SCJ</b>	Для а/м без SCR (Selective Catalytic Reduction)
<b>SFU</b>	Вставляемый датчик, одиночный
<b>SFZ</b>	для специальных автомобилей
<b>SLX</b>	Для автомобилей с пакетом оснащения SLX
<b>SSJ</b>	Для автомобилей с функцией пуск-останов
<b>SSJ</b>	Для автомобилей без функции пуск-останов
<b>THE</b>	Техническое ограничение торговли, запасные части можно получить только у производителя автомобиля.
<b>THI</b>	После замены блока управления насоса или ТНВД необходимо активировать иммобилайзер на СТО изготовителя автомобиля.
<b>THS</b>	Блок управления должен программироваться после установки насоса для впрыска топлива в гарантийной мастерской производителя автомобиля.

<b>TNK</b>	Для однозначной идентификации № Bosch требуется карта данных автомобиля. Компоненты, установленные в изделии, должны совпадать с компонентами карты данных.
<b>TW</b>	Встроенное издание должно определяться в автомобиле или двигателе.
<b>U18</b>	Раннее производство
<b>U26</b>	Новая модель
<b>UPE</b>	Устанавливается 0 928 400 527 вместо 0 928 400 314. Блок управления должен быть перепрограммирован на СТОА BMW.
<b>VAE</b>	для автомобилей с особым снижением токсичности ОГ
<b>VGT</b>	Двигатель VGT
<b>VP4</b>	Внимание! Учитывать № VW на насосе. 059 130 106 A: 0 470 506 046 или заказать замену 0 986 444 033. 059 130 106 D: 0 470 506 002 или заказать замену 0 986 444 006.
<b>WAS</b>	с водоотделителем
<b>WAS</b>	без водоотделителя

<b>WEG</b>	для автомобилей с противоугонным устройством
<b>WEG</b>	для автомобилей без противоугонного устройства
<b>WEI</b>	Цветной опознавательный знак : Белый
<b>WEK</b>	для автомобилей с противоугонным устройством и кондиционером
<b>WFS</b>	управляющий аппарат с интегрированной противоугонной функцией
<b>WGT</b>	Двигатель WGT
<b>WOK</b>	Для транспортных средств с противоугонной функцией, без климатической установки
<b>WW</b>	на выбор
<b>WZT</b>	Для транспортных средств с противоугонной функцией, свободное выключение через ключ зажигания (транспондер-система)
<b>X10</b>	Для цилиндра 1
<b>X56</b>	Для цилиндров 2 - 6
<sup>1</sup>	С датчиком движения иглы

	Легковой автомобиль
	Грузовой автомобиль
	Сельскохозяйственная или строительная машина
	Стационарный двигатель / встроенный двигатель
	Рабочий объем цилиндра в л
	Мощность двигателя в кВт
	Тип двигателя
	Количество цилиндров
	Страна-экспортер
	Дата / Период сборки
	Особый случай
	Информация / Пояснение

	Номер для заказа
	Номер для обмена
	Номер стрелки
	Форсунка в сборе
	Кольцевая прокладка головки цилиндра/шайба теплоизоляции ДНК
	Кольцевая прокладка линии отвода утечек масла ДНК
	Кольцо круглого сечения
	Инжектор общей топливной магистрали
	Насос высокого давления общей топливной магистрали
	ТНВД VE и VR
	Измеритель массы воздуха
	Unit Injection System UIS (насос - форсунка)

	Unit Pump System UPS
	насос-форсунка (PDE)
	Модуль подачи Denoxtronic
	Сторонняя ссылка

<b>12V</b>	Bordspannung 12 Volt	<b>FE2</b>	Nicht für Euro 2/B-Motore	<b>N39</b>	Für Abgasnorm Euro 93 - CEE 19.5 und US 84 LDT
<b>24V</b>	Bordspannung 24 Volt	<b>FFK</b>	Für Frontheizung mit Klimaanlage	<b>NC8</b>	Für Abgaswertecode NC8
<b>3T5</b>	Für Fahrzeuge mit 3,5 t zulässigem Gesamtgewicht	<b>FHE</b>	Für Heizung	<b>NC9</b>	Für Abgaswertecode NC9
<b>4T5</b>	Für Fahrzeuge mit 4,5 t zulässigem Gesamtgewicht	<b>FKR</b>	Für Fahrzeuge mit kurzem Radstand	<b>NOR</b>	Normale Ausführung
<b>AA</b>	Allradantrieb	<b>FL5</b>	Für Abgasnorm L5	<b>NT5</b>	Für Abgaswertecode NT5
<b>AA</b>	Ohne Allradantrieb	<b>FLR</b>	Für Fahrzeuge mit langem Radstand	<b>OBD</b>	Für Fahrzeuge mit On-Board-Diagnose (OBD)
<b>ABS</b>	Für Fahrzeuge mit ABS	<b>FMA</b>	Für Fahrzeuge ohne Airbag	<b>ØBD</b>	Für Fahrzeuge ohne On-Board-Diagnose (OBD)
<b>ABS</b>	Für Fahrzeuge ohne ABS	<b>FMN</b>	Für Fahrzeuge mit Nebenabtrieb	<b>OKN</b>	Ohne Kennzeichnung
<b>AG</b>	Für Fahrzeuge mit automatischem Getriebe	<b>FWT</b>	Für Wärmetauscher	<b>OLK</b>	Für Fahrzeuge ohne Lenkhilfe und ohne Klimaanlage
<b>AGF</b>	Für Fahrzeuge mit Abgasentgiftung	<b>GES</b>	Für Fahrzeuge mit Geschwindigkeitsregelanlage	<b>OWK</b>	Für Fahrzeuge ohne Wegfahrsperre, mit Klimaanlage
<b>AGF</b>	Für Fahrzeuge ohne Abgasentgiftung	<b>GES</b>	Für Fahrzeuge ohne Geschwindigkeitsregelanlage	<b>OWO</b>	Für Fahrzeuge ohne Wegfahrsperre und ohne Klimaanlage
<b>AGR</b>	Abgasrückführung	<b>GLA</b>	GL-Ausführung	<b>RAP</b>	RME (Rapsölmethylester) fähig
<b>AGR</b>	Ohne Abgasrückführung	<b>GLX</b>	GLX-Ausführung	<b>RAP</b>	Nicht RME (Rapsölmethylester) fähig
<b>ATW</b>	Bei Bestellung beachten: in Düsenhalterkombination mit NBF (Nadelbewegungsfühler) ist Düsenwechsel nicht möglich. Eingebautes Erzeugnis muß am Fahrzeug oder Motor ermittelt werden.	<b>GRF</b>	Grundausführung	<b>RLE</b>	Für Rechtslenker
<b>BIO</b>	Für Biokraftstoff	<b>GS</b>	Für Fahrzeuge mit Handschaltgetriebe	<b>RSA</b>	Farbkennzeichnung rosa
<b>BIØ</b>	Nicht für Biokraftstoff	<b>HAG</b>	Für Fahrzeuge mit halbautomatischem Getriebe	<b>SCJ</b>	Für Fahrzeuge mit SCR (Selective Catalytic Reduction)
<b>BKN</b>	Bosch-Ausrüstung ohne Kaltstartanlage	<b>HEF</b>	Für Fahrzeuge mit beheizbarer Frontscheibe	<b>SCJ</b>	Für Fahrzeuge ohne SCR (Selective Catalytic Reduction)
<b>BO</b>	Bosch, nur als Ersatz für Bosch-Ausrüstung	<b>HEF</b>	Für Fahrzeuge ohne beheizbare Frontscheibe	<b>SFU</b>	Steckfühler, einzeln
<b>BOK</b>	Bosch-Ausrüstung mit Kaltstartanlage	<b>HL</b>	Höhenkorrektur	<b>SFZ</b>	Für Sonderfahrzeuge
<b>BOW</b>	Bosch, nur als Ersatz für Bosch-Ausrüstung, für Fahrzeuge mit Wegfahrsperre.	<b>I1B</b>	Für Injector Klasse 1, mit Kennziffer 1 oder Farbkennzeichnung blau	<b>SLX</b>	Für Fahrzeuge mit SLX-Ausstattung
<b>BØW</b>	Bosch, nur als Ersatz für Bosch-Ausrüstung, für Fahrzeuge ohne Wegfahrsperre	<b>I2G</b>	Für Injector Klasse 2, mit Kennziffer 2 oder Farbkennzeichnung grün	<b>SSJ</b>	Für Fahrzeuge mit Start-Stopp-Funktion
<b>BS1</b>	Für BS 1 Applikation	<b>I3K</b>	Für Injector Klasse 3, mit Kennziffer 3	<b>SSJ</b>	Für Fahrzeuge ohne Start-Stopp-Funktion
<b>BS2</b>	Für BS 2 Applikation	<b>KAT</b>	Für Fahrzeuge mit Katalysator	<b>THE</b>	Technische Handelseinschränkung, Ersatz kann nur beim Fahrzeughersteller bezogen werden
<b>CAV</b>	Einbaugleiches Bosch-Erzeugnis oder Teil für CAV	<b>KAT</b>	Für Fahrzeuge ohne Katalysator	<b>THI</b>	Nach Tausch von Pumpen-Steuergerät oder Einspritzpumpe muss die Wegfahrsperre in einer Vertragswerkstatt des Fahrzeugherstellers aktiviert werden.
<b>CSA</b>	Erzeugnis auch online bestellbar "www.partbob.com"	<b>KKA</b>	Mit Kennzeichnung Klasse A	<b>THS</b>	Das Steuergerät muss nach dem Einbau der Einspritzpumpe, in einer Vertragswerkstatt des Fahrzeugherstellers programmiert werden.
<b>DBB</b>	Brennraumdichtring beige packt	<b>KKX</b>	Mit Kennzeichnung Klasse X	<b>TNK</b>	Zur eindeutigen Identifikation der Bosch-Nummer muß die Datenkarte des Fahrzeuges vorliegen. Die beim Erzeugnis aufgeführten Komponenten müssen mit denen in der Datenkarte übereinstimmen.
<b>DBJ</b>	Brennraumdichtring am Injektor vormontiert	<b>KKY</b>	Mit Kennzeichnung Klasse Y	<b>TW</b>	Eingebautes Erzeugnis muss am Fahrzeug oder Motor ermittelt werden.
<b>DBJ</b>	Brennraumdichtring im Lieferumfang nicht enthalten	<b>KKZ</b>	Mit Kennzeichnung Klasse Z	<b>U18</b>	Frühe Produktion
<b>DEP</b>	Für Delphi System	<b>KL</b>	Für Fahrzeuge mit Klimaanlage	<b>U26</b>	Späte Modelle
<b>DKF</b>	Zexel-Fertigung	<b>KL</b>	Für Fahrzeuge ohne Klimaanlage	<b>UPE</b>	Wird 0 928 400 527 als Ersatz von 0 928 400 314 eingebaut, muss das Steuergerät durch eine BMW-Werkstatt umprogrammiert werden.
<b>DRE</b>	Drehzahlmesser Anschluss vorgesehen	<b>KOB</b>	Für Kombiwagen	<b>VAE</b>	Für Fahrzeuge mit verschärfter Abgasentgiftung
<b>E93</b>	Für Abgasnorm EEC 93	<b>KSE</b>	Kaltstarteinrichtung eingebaut	<b>VGT</b>	VGT Motor
<b>E96</b>	Für Abgasnorm EEC 96	<b>KZB</b>	Kennzeichen: blau	<b>VP4</b>	Achtung! VW Nr. auf Pumpe beachten. 059 130 106 A: 0 470 506 046 oder Austausch 0 986 444 033 bestellen. 059 130 106 D: 0 470 506 002 oder Austausch 0 986 444 006 bestellen.
<b>EC9</b>	Für Abgasnorm EEC 99	<b>KZE</b>	Kennzeichen: gelb	<b>WAS</b>	Mit Wasserabscheider
<b>ECO</b>	Für Ecomatic-Ausführung	<b>KZG</b>	Kennzeichen: grün	<b>WAS</b>	Ohne Wasserabscheider
<b>EDC</b>	Elektronische Dieselregelung	<b>KZO</b>	Kalte Zonen	<b>WEG</b>	Für Fahrzeuge mit Wegfahrsperre
<b>EE2</b>	Für Abgasnorm EEC 2000	<b>KZØ</b>	Nicht für kalte Zonen	<b>WEG</b>	Für Fahrzeuge ohne Wegfahrsperre
<b>EEC</b>	Für Abgasnorm EEC V	<b>LH</b>	Für Fahrzeuge mit Lenkhilfe	<b>WEI</b>	Farbkennzeichnung: weiß
<b>EFV</b>	Auch Ersatz für Vorgänger	<b>LH</b>	Für Fahrzeuge ohne Lenkhilfe	<b>WEK</b>	Für Fahrzeuge mit Wegfahrsperre und Klimaanlage
<b>EFZ</b>	Ersatz für Fremderzeugnisse, Satzweise auswechseln	<b>LLE</b>	Für Linkslenker	<b>WFS</b>	Steuergerät mit integrierter Wegfahrsperrenfunktion
<b>EU2</b>	Für Fahrzeuge mit Abgasnorm Euro 2	<b>LWG</b>	Für Lieferwagen	<b>WGT</b>	WGT Motor
<b>EU2</b>	Nicht für Abgasnorm Euro 2	<b>MDR</b>	Mit Drehzahlmesser		
<b>EU3</b>	Für Fahrzeuge mit Abgasnorm Euro 3	<b>MØR</b>	Ohne Drehzahlmesser		
<b>EU3</b>	Nicht für Fahrzeuge mit Abgasnorm Euro 3	<b>MEB</b>	Mit Einspritzsystem Bosch		
<b>EU4</b>	Für Fahrzeuge mit Abgasnorm Euro 4	<b>MG5</b>	Für Fahrzeuge mit Handschaltgetriebe, 5 Gänge		
<b>EU4</b>	Nicht für Fahrzeuge mit Abgasnorm Euro 4	<b>MG6</b>	Für Fahrzeuge mit Handschaltgetriebe, 6 Gänge		
<b>EU5</b>	Für Fahrzeuge mit Abgasnorm Euro 5	<b>MKO</b>	Für Fahrzeuge mit Klimaanlage, ohne Lenkhilfe		
<b>EU5</b>	Nicht für Fahrzeuge mit Abgasnorm Euro 5	<b>MLK</b>	Für Fahrzeuge mit Lenkhilfe und Klimaanlage		
<b>EU6</b>	Für Fahrzeuge mit Abgasnorm Euro 6	<b>MPR</b>	Für Fahrzeuge mit Rußpartikelfilter		
<b>EXW</b>	Tausch der Exzenterwelle nur in Verbindung mit Zahnradpumpe 0 440 020 044	<b>MØR</b>	Für Fahrzeuge ohne Rußpartikelfilter		
<b>FBH</b>	Für Betrieb in grossen Höhen	<b>MRQ</b>	Für Fahrzeuge mit Enddrehzahlregler RQ		
<b>FD3</b>	Für Abgasnorm D3	<b>MVR</b>	Verstellregler, eingebaut		
<b>FE2</b>	Für Euro 2/B-Motore	<b>NO1</b>	Für Abgasnorm ECE R15.04		
		<b>NO3</b>	Für Abgasnorm Euro 93 - CEE 19.5		
		<b>NO5</b>	Für Abgasnorm Euro 96, CEE 95, L3		
		<b>NO7</b>	Für Abgasnorm US 87		
		<b>NO9</b>	Für Abgasnorm US 84 LDT		
		<b>N11</b>	Für Abgasnorm US 90 LDT		
		<b>N13</b>	Für Abgasnorm Euro 96		
		<b>N14</b>	Für Abgasnorm Euro 2000, CEE 2000		
		<b>N25</b>	Für Abgasnorm Euro 2005, EC 2005		
		<b>N25</b>	Nicht für Abgasnorm Euro 2005, EC 2005		